

# KMS Series Microminiature SMT Side Actuated

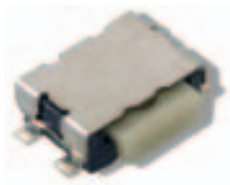

## Features/Benefits

- Compact size
- Excellent tactile feel
- ESD protection
- Positioning pegs for stability
- IP 40 sealing
- RoHS compliant and compatible

## Typical Applications

- Mobile phones, pagers
- PDAs
- Medical handheld monitors
- Consumer electronics
- Telecommunication networks

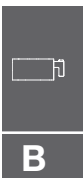

Tactile Switches

## Specification

FUNCTION: Momentary  
CONTACT ARRANGEMENT: SPST, N.O.  
TERMINALS: Gullwing type for SMT  
IP40 Sealed

## Mechanical

OVERLOAD: 20N  
TACTILE FEELING: 15% min. for the 2N version  
25% min for the 2.5N version

Type	Operating force Newtons (grams)	Operating life (operations)	Travel
KMS221G/GP	2N (200) ± 0.5	100 K cycles	0,25 ± 0,15
KMS223G/GP	2N (200) ± 0.5	100 K cycles	0,25 ± 0,15
KMS231G/GP	3N (300) ± 0.6	100 K cycles	0,3 ± 0,15
KMS233G/GP	3N (300) ± 0.6	100 K cycles	0,3 ± 0,15

**Note:** Specifications listed above are for switches with standard options. For information on specific and custom switches, consult Customer Service Center.

## Packaging

Tape and reels in reels of 3,000 pieces.  
External diameter 330mm ± 2mm.

## Electrical

	Silver	Gold
MAXIMUM POWER:	1 VA	0.2 VA
MAXIMUM VOLTAGE:	32 VDC	32 VDC
MAXIMUM CURRENT DC:	50 mA	10 mA
MINIMUM CURRENT DC:	1 mA	1 mA
DIELECTRIC STRENGTH: 250 VDC		
CONTACT RESISTANCE: ≤100 mΩ		
INSULATION RESISTANCE: 10 <sup>9</sup> Ω		
BOUNCE TIME: ≤ 3 ms		

## Environmental

	Silver	Gold
OPERATING TEMPERATURE:	-40°C to 85°C	-40°C to 125°C
STORAGE TEMPERATURE:	-55°C to 85°C	-55°C to 125°C

## Process

Infrared reflow soldering in accordance with IEC 61760-1

## How To Order

Our easy build-a-switch concept allows you to mix and match options to create the switch you need. To order, select desired option from each category and place it in the appropriate box.

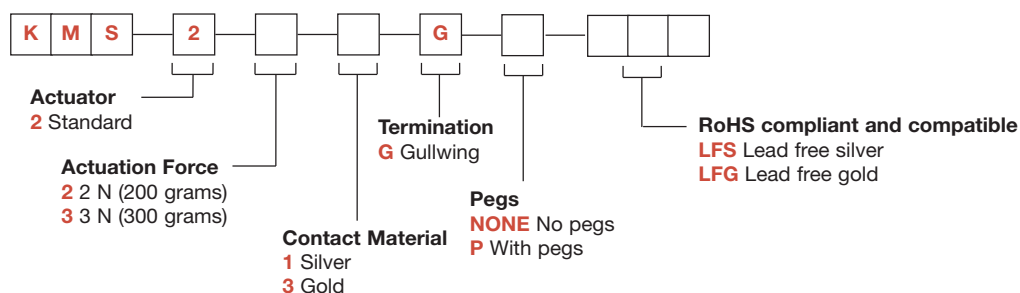

Dimensions are shown: Inch (mm)  
Specifications and dimensions subject to change

# KMS Series Microminiature SMT Side Actuated

Tactile Switches

## KMS

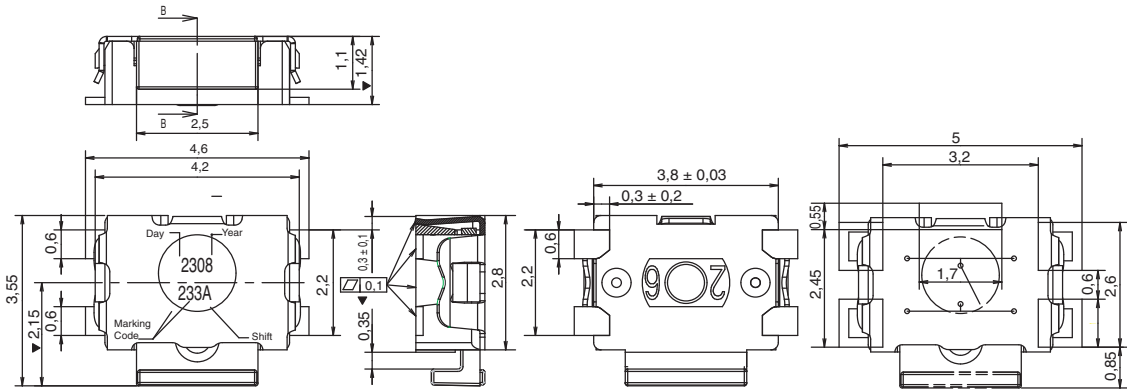

## KMS WITH PEGS

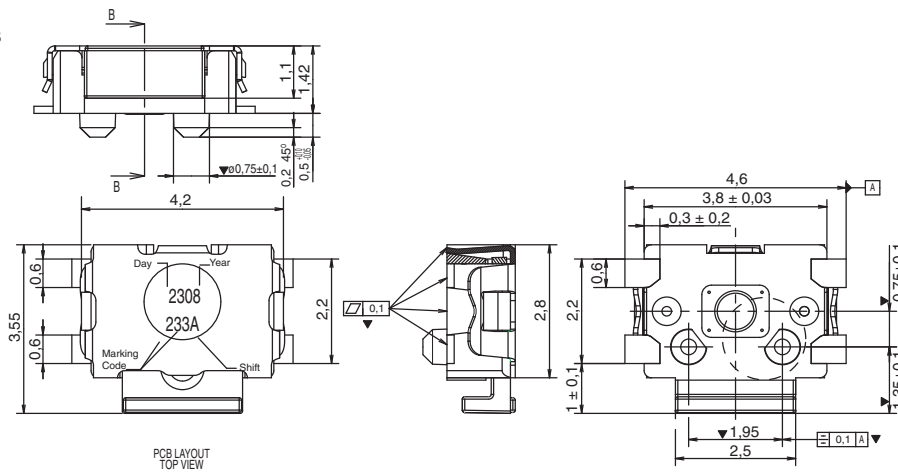

## TAPE & REEL

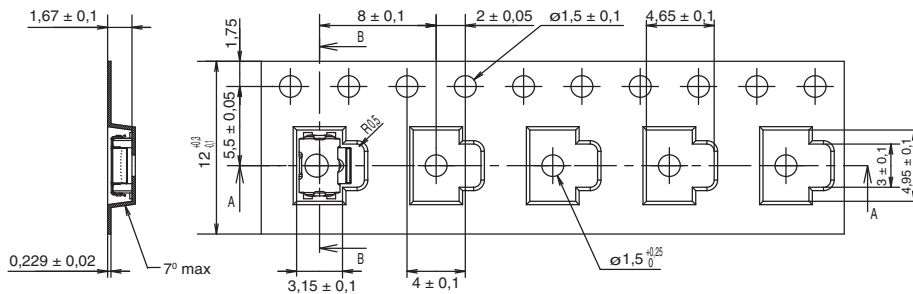

## WITH PEGS

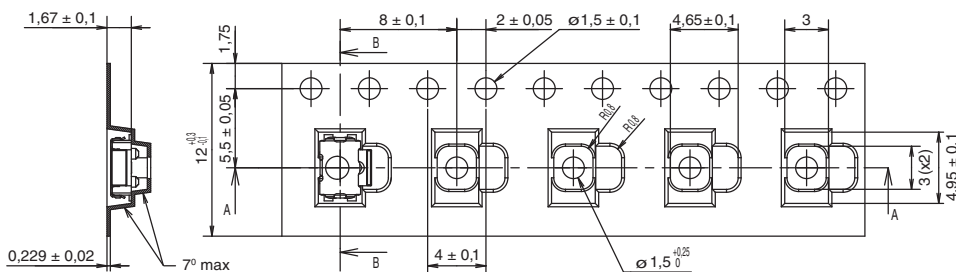

→  
DIRECTION OF FEED

First Angle  
Projection

Dimensions are shown: Inch (mm)  
Specifications and dimensions subject to change



www.ck-components.com