

# DATA SHEET

## **SAA7284**

Terrestrial digital sound decoder for  
conventional intercarrier PLL-IF  
systems

Preliminary specification  
File under Integrated Circuits, IC02

1996 Oct 24

# Terrestrial digital sound decoder for conventional intercarrier PLL-IF systems

## SAA7284

### FEATURES

- Single-chip solution including FM and vision filters, analog demodulator and audio switching
- Dual standard with automatic selection between PAL system I and BGH
- Suitable for conventional intercarrier PLL-IF (single SAW) TV/VCR systems
- Single low-radiation crystal oscillator for improved EMC
- Stereo bitstream audio DACs
- Programmable attenuator for matching levels of NICAM and FM audio sources at the output of the device
- Full EBU specification NICAM 728 demodulation and decoding
- Digital Audio Interface conforming with EBU/IEC 958
- Automatic mute function which switches from NICAM to FM sound when NICAM fails
- Compatible with either single-ended or differential DQPSK input signals
- Microcomputer controlled via I<sup>2</sup>C-bus (up to 400 kHz specification).

### APPLICATIONS

- Television receivers
- Video cassette recorders.

### GENERAL DESCRIPTION

Philips Semiconductors have pushed the boundaries of Stereo Sound further with this addition to the successful Terrestrial Digital Sound Decoder family. The SAA7284 device is an application specific version of the existing SAA7283, with guaranteed improved specification on selected parameters, enabling comparable RF performance in conventional intercarrier PLL-IF systems, to that of the SAA7283 in QSS systems.

### ORDERING INFORMATION

TYPE NUMBER	PACKAGE		
	NAME	DESCRIPTION	VERSION
SAA7284ZP	SDIP52	plastic shrink dual in-line package; 52 leads (600 mil)	SOT247-1
SAA7284GP	QFP64	plastic quad flat package; 64 leads (lead length 1.95 mm); body 14 × 20 × 2.8 mm	SOT319-2

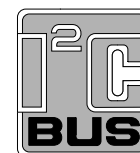

The SAA7284 takes, as input, a second IF (intercarrier) Terrestrial TV PAL signal, and performs all the Differential Quadrature Phase Shift Keying (DQPSK) demodulation, digital decoding and digital-to-analog conversion necessary to produce a complete NICAM receiver on a single integrated circuit.

The demodulator function includes integrated baseband filters for pulse shaping and unwanted signal rejection, automatic gain control, a low jitter integrated VCO, digital monostables for precise data sampling points and a multi-standard controller to enable automatic locking to either a PAL system I or PAL system BGH input signal.

The decoder function performs the descrambling, de-interleaving and reformatting operations required to recover the original data words.

The data words are processed through a stereo digital filter, digital de-emphasis network, second order noise shaper and 256 times oversampling Bitstream audio DAC.

---

**Terrestrial digital sound decoder for  
conventional intercarrier PLL-IF systems**

---

**SAA7284****QUICK REFERENCE DATA**

<b>SYMBOL</b>	<b>PARAMETER</b>	<b>MIN.</b>	<b>TYP.</b>	<b>MAX.</b>	<b>UNIT</b>
$V_{DD}$	supply voltage	4.5	5.0	5.5	V
$I_{DD}$	supply current	–	205	–	mA
$f_{clk}$	clock frequency	–	8.192	–	MHz
$T_{amb}$	operating ambient temperature	–20	+25	+70	°C

# Terrestrial digital sound decoder for conventional intercarrier PLL-IF systems

SAA7284

## BLOCK DIAGRAM

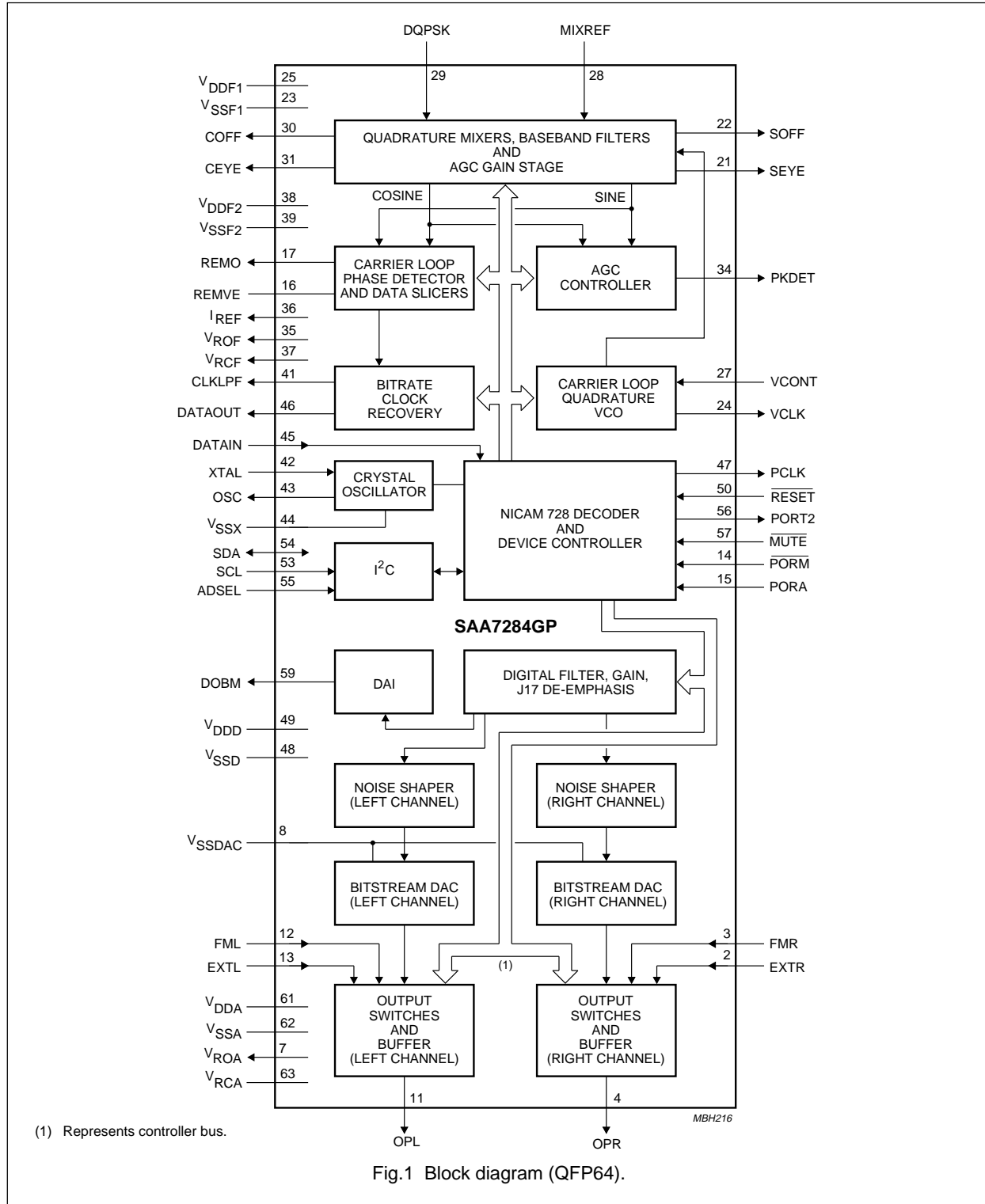

# Terrestrial digital sound decoder for conventional intercarrier PLL-IF systems

SAA7284

**PINNING**

SYMBOL	PIN		DESCRIPTION
	SDIP52	QFP64 <sup>(1)</sup>	
MUTE	1	57	active LOW mute input; function defined by MUTEDEF (control bit in the I <sup>2</sup> C-bus register)
DOBM	2	59	digital audio interface output that can be 3-stated via I <sup>2</sup> C-bus
V <sub>DDA</sub>	3	61	analog supply voltage for the audio channels
V <sub>SSA</sub>	4	62	analog ground connection for the audio channels
V <sub>RCA</sub>	5	63	internal audio reference voltage buffer (high-impedance node)
EXTR	6	2	external analog input to the right audio channel
FMR	7	3	FM sound input to the right audio channel
OPR	8	4	analog output from the right audio channel
n.c.	9 and 10	9 and 10	not connected; left open-circuit in application
V <sub>ROA</sub>	11	7	internal audio reference voltage buffer output
V <sub>SSDAC</sub>	12	8	quiet ground connection to DACs
n.c.	13 and 14	–	not connected; left open-circuit in application
OPL	15	11	analog output from the left audio channel
FML	16	12	FM sound input to the left audio channel
EXTL	17	13	external analog input to the left audio channel
PORM	18	14	active LOW power-on reset mute input; mute cleared by setting silence bit HIGH in I <sup>2</sup> C-bus (internal pull-up)
PORA	19	15	power-on reset audio select input (internal pull-up)
REMVE	20	16	carrier loop-filter connection
REMO	21	17	carrier loop-filter output
SEYE	22	21	sine channel eye pattern output for monitoring
SOFF	23	22	sine channel offset compensator capacitor output
V <sub>SSF1</sub>	24	23	demodulator ground connection 1
VCLK	25	24	carrier loop VCO clock output for monitoring
V <sub>DDF1</sub>	26	25	demodulator supply voltage 1
VCONT	27	27	carrier loop VCO control voltage input
MIXREF	28	28	mixer voltage reference or input when using differential DQPSK signal
DQPSK	29	29	DQPSK input signal
COFF	30	30	cosine channel offset compensator capacitor output
CEYE	31	31	cosine channel eye pattern output for monitoring
PKDET	32	34	AGC peak detector storage capacitor output
V <sub>ROF</sub>	33	35	internal demodulator reference voltage buffered output
I <sub>REF</sub>	34	36	internal demodulator reference current output
V <sub>RCF</sub>	35	37	internal demodulator reference voltage unbuffered output
V <sub>DDF2</sub>	36	38	demodulator supply voltage 2
V <sub>SSF2</sub>	37	39	demodulator ground connection 2
n.c.	38	40	not connected; left open-circuit in application
CLKLPF	39	41	clock loop-phase comparator output

# Terrestrial digital sound decoder for conventional intercarrier PLL-IF systems

SAA7284

SYMBOL	PIN		DESCRIPTION
	SDIP52	QFP64 <sup>(1)</sup>	
XTAL	40	42	8.192 MHz crystal oscillator input
OSC	41	43	8.192 MHz crystal oscillator output
V <sub>SSX</sub>	42	44	crystal oscillator ground connection
DATAIN	43	45	serial data input at 728 kbits/s to decoder
V <sub>SSD</sub>	44	48	digital ground connection
PCLK	45	47	728 kHz output clock to DQPSK demodulator
V <sub>DD</sub>	46	49	digital supply voltage
RESET	47	50	active LOW power-on reset input
DATAOUT	48	46	serial data output at 728 kbits/s from DQPSK demodulator
SCL	49	53	serial clock input for I <sup>2</sup> C-bus
SDA	50	54	serial data input/output for I <sup>2</sup> C-bus
ADSEL	51	55	input that defines I <sup>2</sup> C-bus address bit 0 (internal pull-up)
PORT2	52	56	output that is directly controlled from Port 2 bit in I <sup>2</sup> C-bus

**Note**

1. Pins 1, 5, 6, 18, 19, 20, 26, 32, 33, 51, 52, 58, 60 and 64 are not connected; left open-circuit in application.

Terrestrial digital sound decoder for  
conventional intercarrier PLL-IF systems

SAA7284

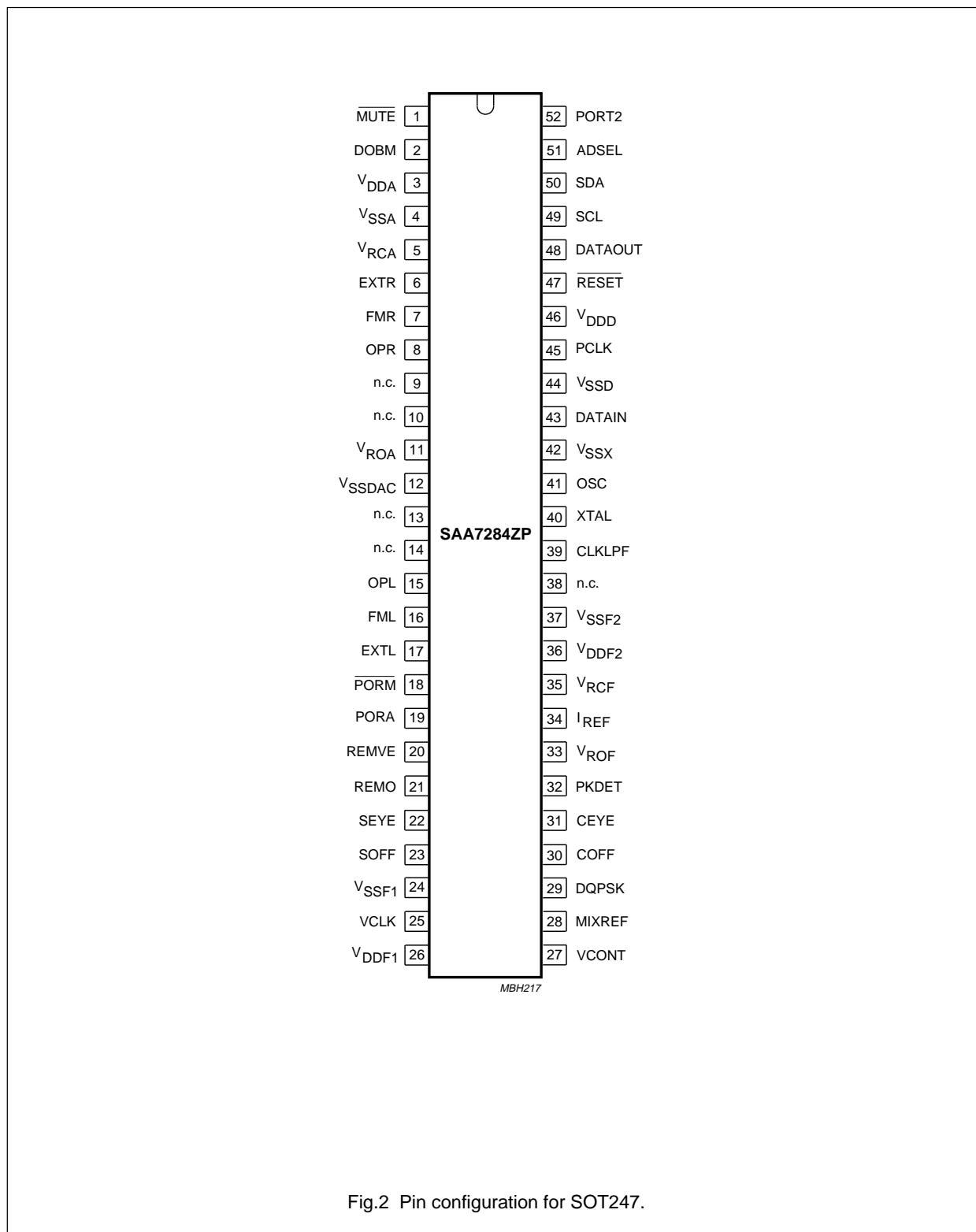

Fig.2 Pin configuration for SOT247.

Terrestrial digital sound decoder for  
conventional intercarrier PLL-IF systems

SAA7284

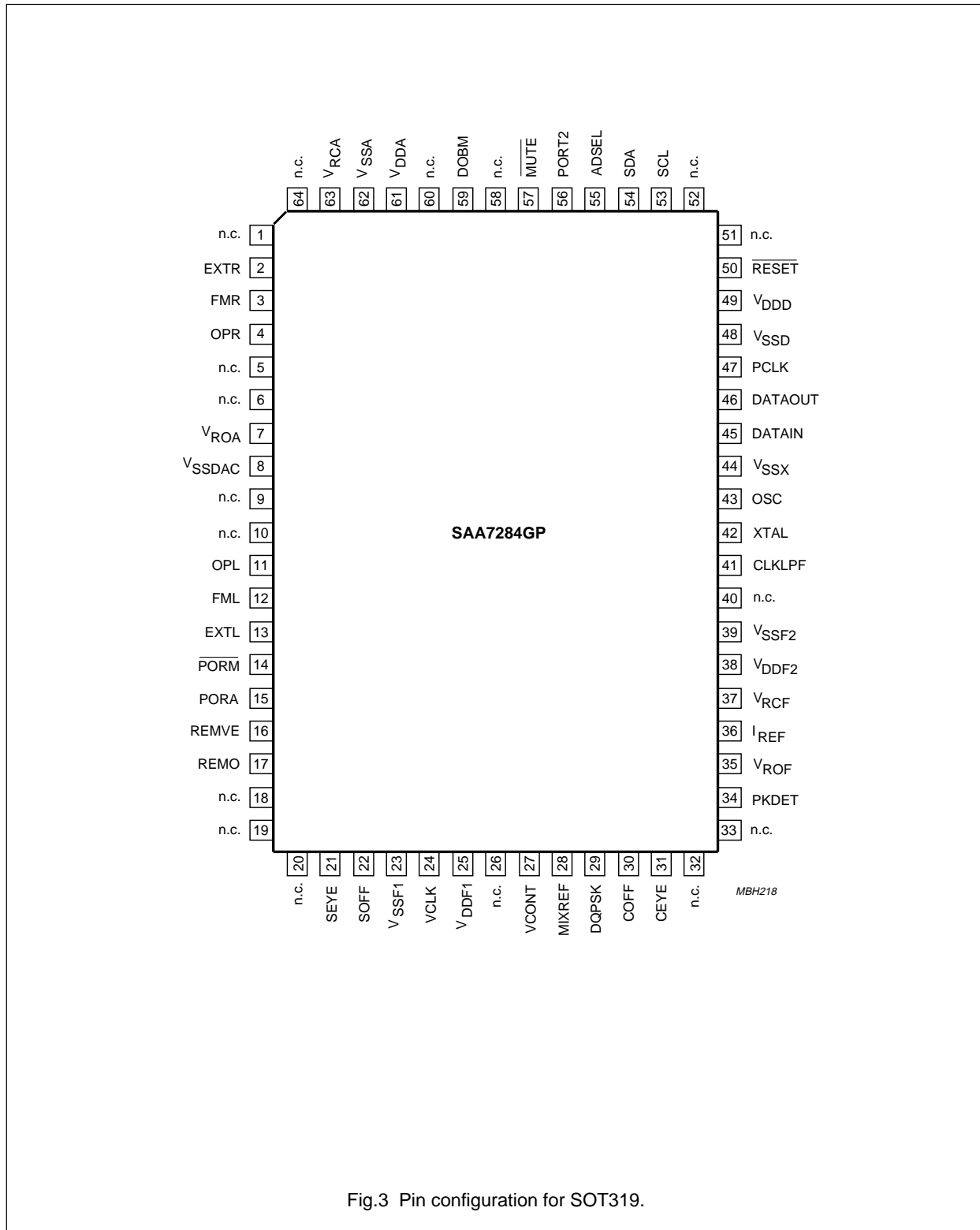

Fig.3 Pin configuration for SOT319.



# Terrestrial digital sound decoder for conventional intercarrier PLL-IF systems

SAA7284

## FUNCTIONAL DESCRIPTION

### DQPSK demodulation

QUADRATURE MIXERS, BASEBAND FILTERS AND AUTOMATIC GAIN CONTROL (AGC)

The DQPSK signal is fed into two differential input mixers, where it is mixed with quadrature phases generated by the carrier-loop quadrature VCO. The quadrature signals modulated onto the NICAM carrier are thus recovered.

The mixers can be driven by either a single-ended or differential source. In single-ended mode, the device is driven directly from the sound IF down-converter into the DQPSK input pin, with the MIXREF pin decoupled. In differential mode, the signal is applied between the DQPSK and MIXREF pins.

The outputs from the mixers are then fed into a pulse-shaping filter, and FM/vision filter stage with improved colour rejection to allow suitable performance with SAW filters. The signal from the filtering stages is then fed into the AGC, which ensures that the phase comparator gain remains constant, irrespective of the input signal level. This is important to maintain the stability of Costas loop PLL.

### AGC CONTROLLER

The AGC controller monitors the I and Q channel signals at the input to the carrier loop-phase comparator and generates a reference voltage to set the AGC output level.

### EYE BUFFER

A differential to the single-ended converter provides the baseband signal as an output at the pins CEYE and SEYE for the I and Q channels respectively for eye-height monitoring.

### BIT RATE CLOCK RECOVERY

The I and Q channels are processed using edge detectors and monostables, which generate a signal with a coherent component at the data symbol rate. The outputs from the I and Q channel monostables are each compared with the clock derived from PCLK (364 kHz nominal), the resultant output is used to derive a 3-state control signal used to control two current sources at the CLKLPF output. This error signal is loop filtered and used to control the master clock oscillator. The bit rate clock, PCLK, and symbol clock are derived from the master clock.

## NICAM 728 decoding

### DECODING FUNCTIONS

The device performs all decoding functions in accordance with the EBU NICAM 728 specification. After locking to the frame alignment word, the data is de-scrambled by application of the defined pseudo random binary sequence, and the device synchronizes to the periodic frame flag bit C0.

The relevant control information and scale factor word is extracted, and with the integrated RAM the data is de-interleaved and the scale factor word is extracted, and expanded to 14 bits. Parity checking on the eleventh bit of each sample word is carried out to reveal any sound sample errors, which if detected are flagged, with the last good sample being held.

### Automatic muting

Enable when AMDIS = LOW. The I<sup>2</sup>C-bus section has two registers which define an upper and lower limit for the automatic muting function. When the number of errors within a 128 ms period exceeds the number stored in the upper error limit register, then the automatic muting will switch the device output to the FM input, (dependent on the relevant control bits in the I<sup>2</sup>C-bus) and mute (set to zero) the data input to the filter (in that order). When the error count in a 128 ms period is less than the value stored in the lower error limit register then the data into the filter is uninterrupted, and the device output is switched back to the DAC (dependent on the value of the relevant control bits in the I<sup>2</sup>C-bus). During the muting operation the open-drain pin  $\overline{\text{MUTE}}$  is pulled LOW and the AM bit in the status-byte is set HIGH. Figure 4 shows the dependency of the automatic muting function on error\_count, RSSF,  $\overline{\text{C4OV}}$ , output state and application mode. The automatic muting function, if enabled, will override user mute via the MUTE pin/bit.

When the transmission is DATA format or currently undefined format (C3 = logic 1) the device will automatically switch to the FM inputs regardless of RSSF/ $\overline{\text{C4OV}}$  states, and whether the automatic muting function AMDIS is enabled or disabled.

---

## Terrestrial digital sound decoder for conventional intercarrier PLL-IF systems

---

SAA7284

### User mute

The error counter is an 8-bit counter which locks at count 255. The counter is reset and its output sent to the I<sup>2</sup>C-bus every 128 ms. This enables the user to interrogate the number of errors occurring within a 128 ms period.

The user can then mute the device by pulling pin  $\overline{\text{MUTE}}$  LOW (this function is also provided by the  $\overline{\text{MUTE}}$  bit in the I<sup>2</sup>C-bus) or setting SILENCE bit LOW in I<sup>2</sup>C-bus to switch input of audio switching buffers to analog ground.

### Switching buffers

The analog switches select between the output of the DACs, the FM input and an external input (EXT). Switching is controlled by bits in the I<sup>2</sup>C-bus and internal switching function. The external analog inputs should be  $\leq 1.1$  V (RMS) at the input pin, and the output buffers have a voltage drive of 1 V (RMS).

### NICAM/FM audio level matching

Differing audio headroom and alignment levels occur between systems I and BGH, due to the differing systems and broadcast standards. In order to match the NICAM and FM audio output levels without requiring application changes, the device will automatically switch in 4.6 dB attenuation network in the NICAM path for system BGH (this can be disabled by setting the NICLEV bit LOW in I<sup>2</sup>C-bus). A programmable attenuation network in the FM path only, controlled by bits in I<sup>2</sup>C-bus, provides additional flexibility for user to match FM and NICAM audio levels (see Table 9).

### Power-on reset state

Two pins control the initial set-up of the device during power-on reset.

#### PORA (Power-On Reset Audio)

When pulled LOW the device will be configured with a 12 dB gain in the oversampling filter and the  $\overline{\text{C4OV}}$  bit in the I<sup>2</sup>C-bus will be set HIGH. This pin when HIGH will configure the device with a 6 dB gain in the oversampling filter and will set  $\overline{\text{C4OV}}$  bit in the I<sup>2</sup>C-bus LOW.

#### $\overline{\text{PORM}}$ (Power-On Reset Mute)

This pin when LOW will mute the output of the device at power-on by setting the SILENCE bit in the I<sup>2</sup>C-bus LOW. To put the device back into a normal mode of operation the SILENCE bit in the I<sup>2</sup>C-bus must be set HIGH.

Terrestrial digital sound decoder for conventional intercarrier PLL-IF systems

SAA7284

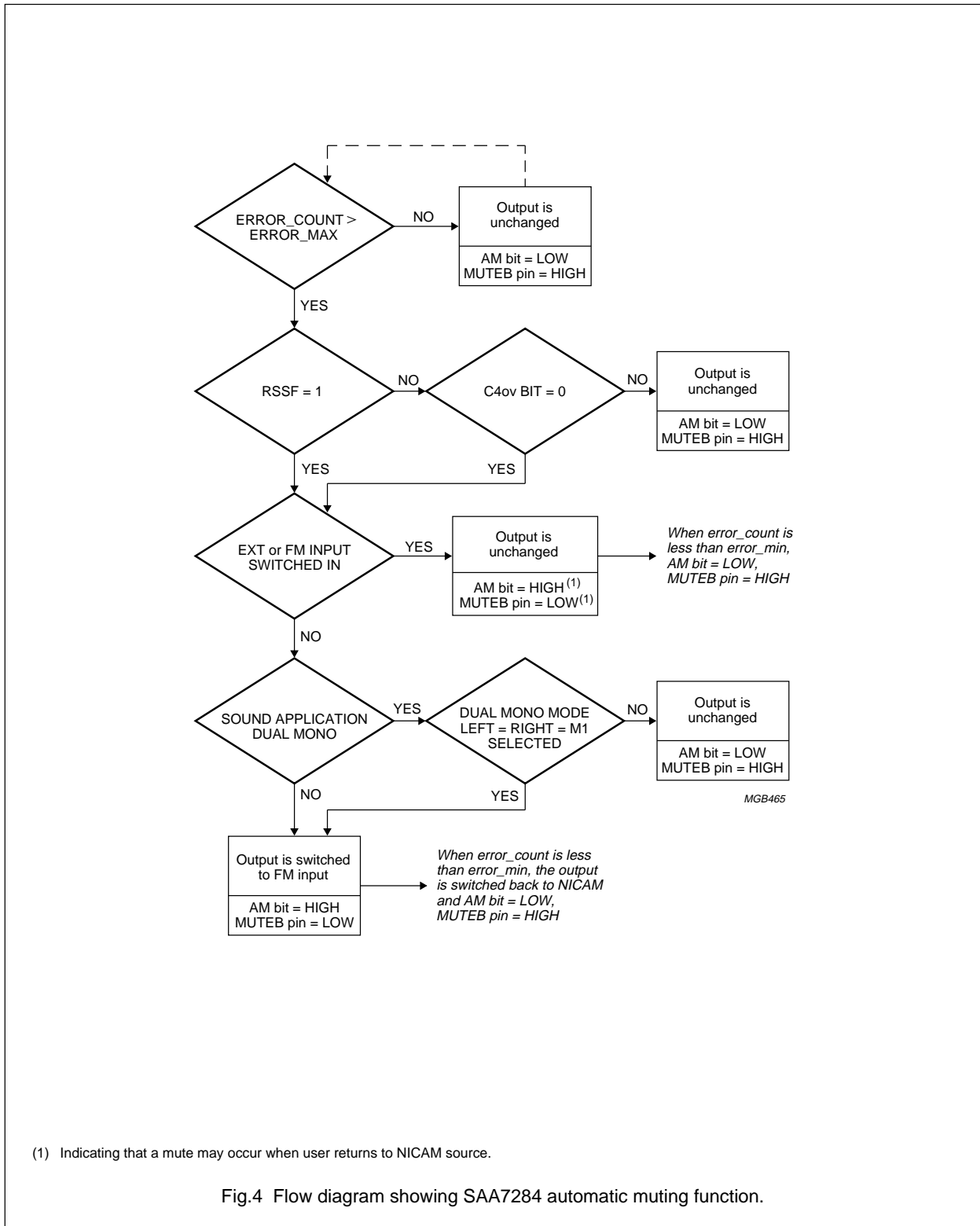

(1) Indicating that a mute may occur when user returns to NICAM source.

Fig.4 Flow diagram showing SAA7284 automatic muting function.

# Terrestrial digital sound decoder for conventional intercarrier PLL-IF systems

SAA7284

## I<sup>2</sup>C-BUS FORMATS

The SAA7284 contains an I<sup>2</sup>C-bus slave transceiver (up to 400 kHz) permitting a master device to:

- Read decoder status information derived from the transmitted digital audio signal
- Read an error count byte to determine the bit error rate for user mute purposes and to indicate quality of NICAM signal
- Write control codes to select PAL I or PAL BGH configurations
- Write control codes to select the available analog switching configurations
- Write upper and lower error count limits for automatic muting function
- Read additional transmitted data bits. Their purpose has yet to be defined but accessibility is provided to allow future services to be implemented in receiver software.

## I<sup>2</sup>C-bus slave address

An address select pin (ADSEL) is provided to allow selection of one of two different slave addresses. The logic state of the ADSEL pin is reflected in the least significant bit of the I<sup>2</sup>C-bus slave address.

Slave address = 101101X (R/ $\bar{W}$ ) [ADSEL = 1, address = B6 (R/ $\bar{W}$ ) ADSEL = 0, address = B4 (R/ $\bar{W}$ )].

**Table 1** SAA7284 slave address

BITS							
A7	A6	A5	A4	A3	A2	A1	A0
1	0	1	1	0	1	selected by ADSEL	read/write

The SAA7284 does not acknowledge the I<sup>2</sup>C-bus general call address.

## Slave receiver format

The slave receiver format is shown in Table 2.

**Table 2** Slave receiver format

START	slave_addr	ACK	sub_addr	ACK	data_byte	ACK	n-bytes	data_byte	ACK	STOP
-------	------------	-----	----------	-----	-----------	-----	---------	-----------	-----	------

**Table 3** Explanation of Table 2

ITEM	DESCRIPTION
START	I <sup>2</sup> C-bus start condition
Slave_addr	101101XW
X	logic 0 when ADSEL = 0; logic 1 when ADSEL = 1
W	logic 0, I <sup>2</sup> C-bus write to slave receiver
ACK	I <sup>2</sup> C-bus acknowledge condition generated by slave receiver
Sub_addr	sub-address range 00 to 04 (HEX)
Data_byte	data byte transmitted to slave receiver
STOP	I <sup>2</sup> C-bus stop condition

The sub-address is auto-incremented by the SAA7284, for each data byte received. When the sub-address is equal to 04 (HEX), on reception of the next data byte, the sub-address will reset to 00 (HEX).

# Terrestrial digital sound decoder for conventional intercarrier PLL-IF systems

SAA7284

## I<sup>2</sup>C-bus slave receiver register map

**Table 4** Slave receiver data byte

SUB-ADDRESS	D7	D6	D5	D4	D3	D2	D1	D0
000	M1/ $\overline{M2}$	DMSEL	SSWIT3	SSWIT2	SSWIT1	PORT2	MUTEDEF	AMDIS
001	EMAX7	EMAX6	EMAX5	EMAX4	EMAX3	EMAX2	EMAX1	EMAX0
010	EMIN7	EMIN6	EMIN5	EMIN4	EMIN3	EMIN2	EMIN1	EMIN0
011	$\overline{C4OV}$	$\overline{MUTE}$	SILENCE	DAIE	FM3	FM2	FM1	FM0
100	ASYS	BG/ $\overline{i}$	NICLEV	STLOCK	–	–	–	–

### M1/ $\overline{M2}$

This bit selects either mono channel M1 or M2 to be the output on the left and right channel dependent on the transmitted control bits C1 and C2 indicating a mono transmission and the value of bit DMSEL (see Table 5). Power-on resets to logic 1.

### DMSEL

DMSEL is the dual mono selection bit, for transmissions consisting of two independent mono signals. Selection is in conjunction with M1/ $\overline{M2}$  (see Table 5). Power on resets to logic 0.

### SSWIT1, SSWIT2 AND SSWIT3

These bits control the analog switching, selecting between the FM, external, and NICAM signals. With the NICAM source the signals select whether the de-emphasis is performed and what gain is applied after the filtering and de-emphasis stage. The signal states and their meaning are listed in Table 7. Power-on resets to 010 with PORA pin HIGH, and to 011 with PORA pin LOW.

### PORT2

PORT2 controls a bit out, providing direct access to a dedicated output pin (PORT2) via the I<sup>2</sup>C-bus. See Table 6. Power-on resets to logic 0.

### MUTEDEF

This defines the operation of the user definable  $\overline{MUTE}$  pin or MUTE I<sup>2</sup>C-bus bit when it is pulled LOW externally or set LOW in the I<sup>2</sup>C-bus respectively.

When this bit is HIGH, pulling the  $\overline{MUTE}$  pin/I<sup>2</sup>C-bus bit LOW will mute (set to zero) the digital data and switch the output to the FM input, depending on relevant control bits (see Table 8). When this bit is LOW, pulling the  $\overline{MUTE}$  pin/I<sup>2</sup>C-bus bit LOW will only mute the digital data under the same conditions. Power-on resets to LOW.

### AMDIS

This bit enables and disables the automatic mute function. Power-on resets to enabled = LOW.

### EMAX7 TO EMAX0

This is the upper error limit register which defines the number of errors in 128 ms period which will cause automatic mute to switch IN. User definable, but power-on resets to 50 (HEX).

### EMIN7 TO EMIN0

This is the lower error limit register which defines the number of errors in 128 ms period which will cause automatic mute to switch OUT. User definable, but power-on resets to 14 (HEX).

### $\overline{C4OV}$

When set LOW this bit overrides the status of the transmitted C4-bit when muting. When this bit is HIGH muting takes place in accordance with EBU specification. Power-on resets to HIGH when the PORA pin is held LOW during power-up, and power-on resets to LOW when PORA is HIGH.

### $\overline{MUTE}$

This reflects the function of the MUTE pin. When this bit is set LOW the external MUTE pin is pulled LOW and the action is dependent on the MUTEDEF bit (see Table 8). Power-on resets to HIGH.

### SILENCE

When set LOW this bit silences the outputs of the device by switching the input of the audio switching buffers to analog ground. When the  $\overline{PORM}$  pin is held LOW at power-on reset the silence bit is initialized to zero. With PORM bit HIGH the silence bit is initialized HIGH.

## Terrestrial digital sound decoder for conventional intercarrier PLL-IF systems

SAA7284

**DAIE**

When set HIGH this bit switches in the Digital Audio Interface output to the DOBM pin. When set LOW the DOBM output is 3-stated. Power-on resets to HIGH.

**FM3 TO FM0**

These bits set the level of attenuation of the FM audio signal (see Table 9). Power-on resets 0000 = 0 dB attenuation.

**ASYS**

When this bit is HIGH it activates the automatic standard switch mode. When set LOW, the standard must be set by the  $BG\bar{I}$  bit. Power-on resets to HIGH.

 **$BG\bar{I}$** 

When this bit is HIGH it switches the DQPSK demodulator to system BGH and attenuates the digital audio level by

4.6 dB (if NICLEV is set HIGH). When LOW, the DQPSK demodulator switches to system I (with no 4.6 dB attenuation). Power-on resets to HIGH.

**NICLEV**

When this bit is set LOW it overrides the 4.6 dB NICAM audio level compensation, irrespective of whether the device is in automatic or manual system mode. When set HIGH the 4.6 dB compensation level is applied in system BGH. Power-on resets to HIGH.

**STLOCK**

When STLOCK is set HIGH it will stop the automatic system switch after the device has achieved an INSYNC condition, should the demodulator lose lock at any time. This minimizes the re-acquisition time. When set LOW the device will be permitted to change system after an INSYNC condition has been reached. Power-on resets to LOW.

**Table 5** Output as a function of  $M1/\overline{M2}$  and DMSEL

DMSEL	$M1/\overline{M2}$	FUNCTION
0	0	selects DIGITAL; L = M2, R = M2
0	1	selects DIGITAL; L = M1, R = M1
1	0	selects DIGITAL; L = M2, R = M1
1	1	selects DIGITAL; L = M1, R = M2

**Table 6** Port 2 control

PORT2	PIN OUTPUT STATE
0	LOW
1	HIGH

**Table 7** SSWIT signal states and function

SSWIT3	SSWIT2	SSWIT1	FUNCTION
0	0	0	NICAM source de-emphasis switched out, no gain
0	0	1	NICAM source de-emphasis switched in, no gain
0	1	0	NICAM source de-emphasis switched in, +6 dB gain; power-on reset when PORA = HIGH
0	1	1	NICAM source de-emphasis switched in, +12 dB gain; power-on reset when PORA = LOW
1	X <sup>(1)</sup>	0	external inputs switched in, no change to previous de-emphasis/gain setting
1	X	1	FM inputs switched in, no change to previous de-emphasis/gain setting

**Note**

1. Where X = don't care.

# Terrestrial digital sound decoder for conventional intercarrier PLL-IF systems

SAA7284

**Table 8** Action of pulling  $\overline{\text{MUTE}}$  pin/I<sup>2</sup>C-bus bit LOW

TRANSMITTED C4 BIT (RSSF)	$\overline{\text{C4OV}}$	TRANSMISSION MODE	OUTPUT ACTION <sup>(1)</sup>	
			MUTEDEF = 1	MUTEDEF = 0
1	1 or 0	stereo/mono/dual mono with L and R = M1	mute digital data and switch to FM	mute digital data only
1	1 or 0	dual mono with M2 selected in either L or R	no action	no action
0	1	all modes	no action	no action
0	0	all modes	mute digital data and switch to FM	mute digital data only

**Note**

1. With  $\overline{\text{MUTE}}$  pin/I<sup>2</sup>C-bus bit pulled LOW. If user has manually selected FM or NICAM inputs, no switching will occur.

**Table 9** FM attenuation control

FM ATTENUATION (dB)	FM3	FM2	FM1	FM0
0	0	0	0	0
1	0	0	0	1
2	0	0	1	0
3	0	0	1	1
4	0	1	0	0
5	0	1	0	1
6	0	1	1	0
7	0	1	1	1
8	1	0	0	0
9	1	0	0	1
10	1	0	1	0
11	1	0	1	1
12	1	1	0	0
Not defined	1	1	0	1
Not defined	1	1	1	0
Not defined	1	1	1	1

**Slave transmitter format**

The slave transmitter format is shown in Table 10.

**Table 10** Slave transmitter format

START	slave_addr	ACK	data_byte	ACK	n-bytes	data_byte	$\overline{\text{ACK}}$	STOP
-------	------------	-----	-----------	-----	---------	-----------	-------------------------	------

# Terrestrial digital sound decoder for conventional intercarrier PLL-IF systems

SAA7284

**Table 11** Explanation of Table 10

ITEM	DESCRIPTION
START	I <sup>2</sup> C-bus start condition
Slave_addr	101101XR
X	logic 0 when ADSEL = 0; logic 1 when ADSEL = 1
R	logic 1, I <sup>2</sup> C-bus read from slave transmitter
ACK	I <sup>2</sup> C-bus acknowledge condition generated by slave receiver
Data_byte	data byte transmitted from slave receiver
$\overline{\text{ACK}}$	master device negative acknowledge to indicate last byte
STOP	I <sup>2</sup> C-bus stop condition

**I<sup>2</sup>C slave transmitter register map**

The bus master can perform single-byte, two-byte, three-byte, four-byte or five-byte read in the order shown in Table 12.

**Table 12** Slave transmitter data byte

BYTE	D7	D6	D5	D4	D3	D2	D1	D0
STATUS BYTE 1	PONRES	S/ $\overline{\text{M}}$	D/ $\overline{\text{S}}$	VDSP	RSSF	O $\overline{\text{S}}$	AM	$\overline{\text{CFC}}$
ERROR BYTE	ERR7	ERR6	ERR5	ERR4	ERR3	ERR2	ERR1	ERR0
AD BYTE 0	AD7	AD6	AD5	AD4	AD3	AD2	AD1	AD0
AD BYTE 1	OVW	SAD	0	C11	C12	AD10	AD9	AD8
STATUS BYTE 2	C1	C2	C3	BG/ $\overline{\text{I}}$	0	0	0	0

**PONRES**

When set HIGH this bit indicates that a power-on reset has occurred. It is cleared after the status byte has been read.

**S/ $\overline{\text{M}}$** 

This bit gives the stereo or mono broadcast indication. Set HIGH indicates stereo transmission.

**D/ $\overline{\text{S}}$** 

When HIGH this bit indicates a dual mono broadcast.

**VDSP**

When this bit is HIGH, it indicates that the digital data transmission is a sound source. When LOW the transmission is either data or undefined format.

**RSSF**

This bit reflects the state of the C4 bit in the NICAM transmission. When set LOW, the FM sound content does not match the digital transmission, and switching to FM by automatic mute or setting  $\overline{\text{MUTE}}$  LOW is prevented (if C4OV = HIGH).

**O $\overline{\text{S}}$** 

When HIGH this bit indicates that the device has both frame and C0 (16 frame) synchronization.

**AM**

When HIGH this bit indicates that the automatic mute function has switched from NICAM to FM. When LOW the automatic mute function has not activated a switch.

 **$\overline{\text{CFC}}$** 

When LOW this bit indicates a configuration change at the C0 (16 frame) boundary. It is reset after reading the status byte.

**ERR7 TO ERR0**

These bits indicate the number of errors occurring in the previous 128 ms period.

**AD7 TO AD0**

These bits contain the eight least significant additional data bits.



## Terrestrial digital sound decoder for conventional intercarrier PLL-IF systems

SAA7284

**OVW**

This bit is set when new additional data bits are written to the I<sup>2</sup>C-bus without the previous bits being read.

AD10, AD9 AND AD8

These are the three most significant additional data bits.

**SAD**

This bit is set HIGH when new additional data is written into the I<sup>2</sup>C-bus, and cleared by the action of reading the data.

C1, C2 AND C3

These are the transmitted control bits, see Table 13.

**CI1 AND CI2**

These are the CI bits decoded by majority logic from the parity checks of the last ten samples in a frame.

BG $\bar{I}$ 

When set HIGH this bit indicates that the DQPSK demodulator is switched to system BGH. When LOW, indicates that DQPSK demodulator is switched to system I.

**Indicator bits**

Table 13 is the truth table for the indicator bits.

**Table 13** Indicator bits functional truth table

TRANSMISSION	C1	C2	C3	S $\bar{M}$	D $\bar{S}$	VDSP	$\bar{OS}$
Stereo	0	0	0	1	0	1	1
M1 + M2	0	1	0	0	1	1	1
M1 + data	1	0	0	0	0	1	1
Transparent data	1	1	0	0	0	0	1
Any currently undefined combination of C1, C2 and C3				0	0	0	1
Decoder unsynchronized ( $\bar{OS}$ = logic 0)				0	0	0	0

# Terrestrial digital sound decoder for conventional intercarrier PLL-IF systems

SAA7284

## DIGITAL AUDIO INTERFACE IEC/EBU 958

### Block structure

The output is grouped into a block of 192 consecutive frames providing, for each channel the 192 channel status data bits. The start of a block is designated by a special sub-frame preamble.

### Frame structure

Each frame is uniquely composed of two sub-frames. The rate of transmission of frames corresponds exactly to the source sampling frequency. In the 2-channel operation, samples taken from both channels are transmitted by time multiplexing in consecutive sub-frames. Sub-frames related to Channel 1 (left or 'A' channel in stereophonic operation and primary channel in monophonic operation) normally use preamble M. However the preamble is changed to preamble B once every 192 frames. This defines the block structure used to organize the channel status information. Sub-frames of Channel 2 (right or 'B' channel in stereophonic operation and secondary channel in monophonic operation) always use preamble W.

### Sub-frame structure

Each frame is divided into 32 time-slots numbered 0 to 31.

Time-slots 0 to 3 carry one of three permitted preambles. These are used to affect synchronization of sub-frames, frames and blocks.

Time-slots 4 to 27 carry the audio sample word in linear two's complement representation. The most significant bit is carried by time-slot 27.

Time-slot 28 carries the validity flag associated with the audio sample word. This flag is set to logic 0 if the audio sample is reliable. If set to logic 1 then the sample is unreliable.

Time-slot 29 carries one bit of the user data channel. In this application this is not used and so is set to logic 0.

Time-slot 30 carries one bit of the channel status word associated with the audio channel transmitted in the same sub-frame.

Time-slot 31 carries a parity bit such that time-slots 4 to 31 inclusive will carry an even number of ones and an even number of zeros.

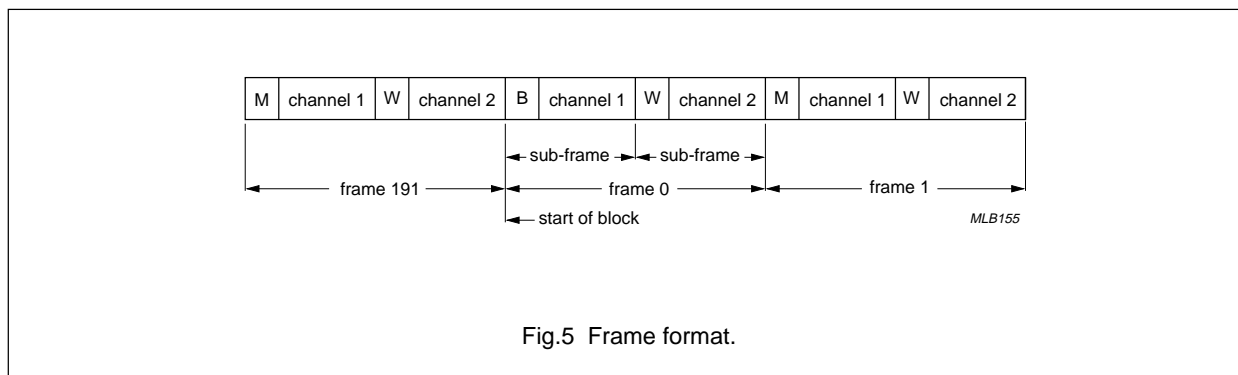

Fig.5 Frame format.

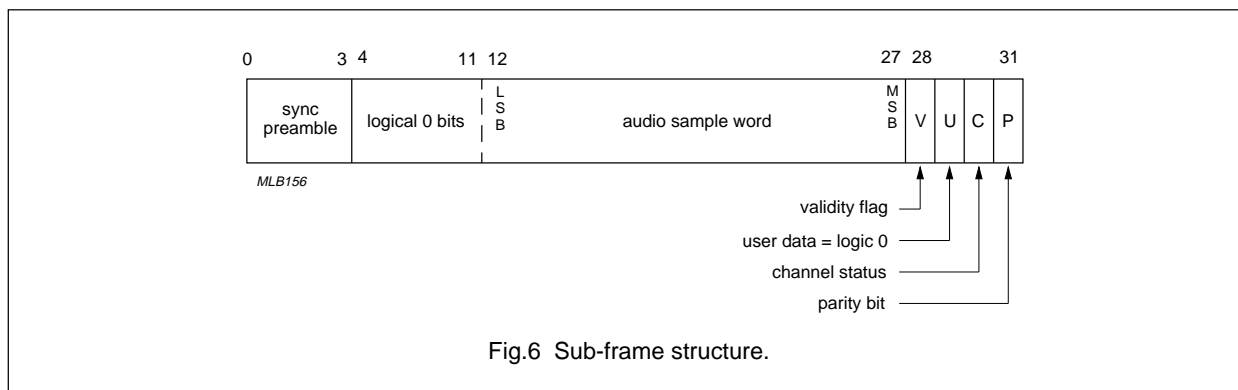

Fig.6 Sub-frame structure.

# Terrestrial digital sound decoder for conventional intercarrier PLL-IF systems

SAA7284

## Channel coding

Time-slots are encoded as biphasic mark data. Each bit transmitted is represented by a symbol comprising two consecutive binary states. The first state of a symbol is always different from the second state of the previous symbol. The second state of the symbol is identical to the first if the bit being transmitted is logic 0, however it is different if the bit is logic 1 (see Table 14).

**Table 14** Channel coding

PRECEDING STATE	0	1
TRANSMITTED BIT	CHANNEL CODING	
0	11	00
1	10	01

## Preambles

Preambles are specific patterns providing synchronization and identification of the sub-frames and blocks.

A set of three preambles is used. These preambles are transmitted in the time allocated to four time-slots and are represented by eight successive states. The first state of the preamble is always different from the second state of the previous symbol. Depending on this state the preambles are as shown in Table 15.

**Table 15** Preambles

PRECEDING STATE	0	1
PREAMBLE	CHANNEL CODING	
B	11101000	00010111
M	11100010	00011101
W	11100100	00011011

The preambles preceding each digital audio sample are used to indicate the beginning of a sample as follows:

- **Preamble B** indicates the start of Channel A data and the beginning of a block
- **Preamble M** indicates the start of Channel A data but not the beginning of a block
- **Preamble W** indicates the start of Channel B data.

## Channel status

The channel status information is organized in 192-bit words. The first bit of each word is carried in the frame with Preamble B. The 192-bit word is organized into sections as shown in Table 16.

**Table 16** Channel status codes

BIT	CODE	DESCRIPTION
0	0	consumer
1	0	sound data
2	1	digital copy permitted
3 and 4	00	indicates digital de-emphasis switched in
	11	indicates digital de-emphasis switched out
5	0	–
6 and 7	00	–
8 to 15	00110001	category code
16 to 19	0000	source code (don't care)
20 to 23	0000	channel number (don't care)
24 to 27	1100	sampling frequency (32 kHz)
28 and 29	00	clock accuracy (level II)
30 to 191	all 0s	–

# Terrestrial digital sound decoder for conventional intercarrier PLL-IF systems

SAA7284

## LIMITING VALUES

In accordance with the Absolute Maximum Rating Systems (IEC 134).

SYMBOL	PARAMETER	CONDITIONS	MIN.	MAX.	UNIT
$V_{DDF1}, V_{DDF2}, V_{DDA}$	supply voltage (all supplies)	note 1	-0.3	+6.5	V
$V_{SSF1}, V_{SSF2}, V_{SSA}$	ground supply voltage		$V_{SSD} - 0.5$	$V_{SSD} + 0.5$	V
$V_{I(max)}$	maximum input voltage (any input)		0	$V_{DD}$	V
$V_{O(max)}$	maximum output voltage		0	$V_{DD}$	V
$I_{IOK}$	DC input or output diode current		-	$\pm 20$	mA
$I_{O(max)}$	output current (each output)		-	$\pm 10$	mA
$T_{amb}$	ambient operating temperature		-20	+70	°C
$T_{stg}$	storage temperature		-55	+125	°C
$V_{stat(HBM)}$	electrostatic handling Human Body Model	note 2	-2000	+2000	V
$V_{stat(MM)}$	Machine Model	note 3	-200	+200	V

## Notes

1. All  $V_{DD}$  and  $V_{SS}$  connections must be made externally to the same power supply.
2. Electrostatic handling is equivalent to discharging a 100 pF capacitor via a 1.5 k $\Omega$  series resistor with a 15 ns rise time.
3. Electrostatic handling is equivalent to discharging a 200 pF capacitor via a 0  $\Omega$  series resistor with a 15 ns rise time.

## QUALITY AND RELIABILITY

This device will meet Philips Semiconductors General Quality Specification for Business group "Consumer Integrated Circuits SNW-FQ-611-Part E".

# Terrestrial digital sound decoder for conventional intercarrier PLL-IF systems

SAA7284

## SYSTEM PERFORMANCE

### Bit Error Rate (BER)

Table 17 shows input signal conditions which typically produce bit error rates of less than  $10^{-3}$ . Signal levels given in dB are related to the picture carrier reference level (0 dB) and based on the output level of the set up as shown in Fig.8. All measurements are at RF and using Philips Semiconductors SAA7284 Applications Board.

**Table 17** System performance

INPUT SIGNAL CONDITIONS <sup>(1)</sup>	SYSTEM I	SYSTEM BG		UNIT
	SAW A <sup>(2)</sup>	SAW B <sup>(2)</sup>	SAW C <sup>(3)</sup>	
Picture carrier RF level (FM deviation = $\pm 50$ kHz)	35	35	35	dB
NICAM level with respect to picture carrier (FM deviation = $\pm 50$ kHz)	-35	-34	-32	dB
FM overmodulation	>120	>100	>100	kHz

### Notes

- Measurements made with colour bar at 100% modulation.
  - FM level = -10 dB system I; -13 dB system BG.
  - NICAM level = -20 dB (unless otherwise specified).
- 10 dB sound shelf with extended bandwidth for NICAM signal.
- 14 dB sound shelf with extended bandwidth for NICAM signal.

### Acquisition time

Maximum acquisition time = 1 s, measured from power-on to reset in-sync condition achieved.

# Terrestrial digital sound decoder for conventional intercarrier PLL-IF systems

SAA7284

**CHARACTERISTICS**

$V_{DD} = 4.5$  to  $5.5$  V;  $T_{amb} = -20$  to  $+70$  °C; unless otherwise specified.

SYMBOL	PARAMETER	CONDITIONS	MIN.	TYP.	MAX.	UNIT
<b>Digital supplies</b> (note 1)						
$V_{DDD}$	digital supply voltage		4.5	5.0	5.5	V
$V_{SSD}$	digital ground supply voltage		–	0	–	V
$I_{DDD}$	digital supply current		–	15	–	mA
<b>Audio supplies</b> (note 1)						
$V_{DDA}$	audio supply voltage		4.5	5.0	5.5	V
$V_{SSA}$	audio ground supply voltage		–	0	–	V
$V_{SSDAC}$	DAC ground supply voltage		–	0	–	V
$I_{DDA}$	audio supply current		–	19	–	mA
<b>Demodulator supplies</b> (note 1)						
$V_{DDF1}$	1st front-end supply voltage		4.5	5.0	5.5	V
$V_{SSF1}$	1st front-end ground supply voltage		–	0	–	V
$I_{DDF1}$	1st front-end supply current		–	46	–	mA
$V_{DDF2}$	2nd front-end supply voltage		4.5	5.0	5.5	V
$V_{SSF2}$	2nd front-end ground supply voltage		–	0	–	V
$I_{DDF2}$	2nd front-end supply current		–	125	–	mA
<b>Digital inputs</b>						
DATAIN (TTL/CMOS COMPATIBLE INPUT LEVELS)						
$V_{IL}$	LOW level input voltage		0	–	0.8	V
$V_{IH}$	HIGH level input voltage		2.0	–	$V_{DD}$	V
$I_{LI}$	input leakage current		–10	–	+10	$\mu$ A
$C_i$	input capacitance		–	–	10	pF
ADSEL, $\overline{PORM}$ AND PORA (TTL/CMOS COMPATIBLE INPUT LEVELS WITH INTERNAL PULL-UP)						
$V_{IL}$	LOW level input voltage		0	–	0.8	V
$V_{IH}$	HIGH level input voltage		2.0	–	$V_{DD}$	V
$R_{i(pu)}$	input pull-up resistance		–	50	–	k $\Omega$
$C_i$	input capacitance		–	–	10	pF
$\overline{RESET}$ AND SCL (CMOS/I <sup>2</sup> C-BUS INPUT LEVELS WITH SCHMITT TRIGGER)						
$V_{IL}$	LOW level input voltage		0	–	1.5	V
$V_{IH}$	HIGH level input voltage		3.0	–	$V_{DD}$	V
$V_{hys}$	hysteresis		–	$0.05V_{DD}$	–	V
$I_{LI}$	input leakage current		–10	–	+10	$\mu$ A
$C_i$	input capacitance		–	–	10	pF

# Terrestrial digital sound decoder for conventional intercarrier PLL-IF systems

SAA7284

SYMBOL	PARAMETER	CONDITIONS	MIN.	TYP.	MAX.	UNIT
<b>Digital input/output</b>						
SDA (I <sup>2</sup> C-BUS LEVELS WITH SCHMITT TRIGGER/OPEN-DRAIN OUTPUT)						
V <sub>IL</sub>	LOW level input voltage		0	–	1.5	V
V <sub>IH</sub>	HIGH level input voltage		3.0	–	V <sub>DD</sub>	V
V <sub>hys</sub>	hysteresis		0.05V <sub>DD</sub>	–	–	V
I <sub>LI</sub>	input leakage current		–10	–	+10	μA
C <sub>i</sub>	input capacitance		–	–	10	pF
V <sub>OL</sub>	LOW level output voltage	I <sub>OL</sub> = +3 mA	0	–	0.4	V
C <sub>L</sub>	load capacitance					
	active pull-up		–	–	400	pF
	passive pull-up		–	–	200	pF
MUTE (TTL/CMOS COMPATIBLE INPUT LEVELS/OPEN-DRAIN OUTPUT WITH INTERNAL PULL-UP)						
V <sub>IL</sub>	LOW level input voltage		0	–	0.8	V
V <sub>IH</sub>	HIGH level input voltage		2.0	–	V <sub>DD</sub>	V
C <sub>i</sub>	input capacitance		–	–	10	pF
V <sub>OL</sub>	LOW level output voltage	I <sub>OL</sub> = +3 mA	0	–	0.4	V
V <sub>OH</sub>	HIGH level output voltage	I <sub>OH</sub> = –3 mA	2.4	–	V <sub>DD</sub>	V
C <sub>i</sub>	load capacitance with active pull-up		–	–	50	pF
Z <sub>i</sub>	input impedance		–	50	–	kΩ
<b>Digital outputs</b>						
PORT2, PCLK AND DATAOUT (PUSH-PULL OUTPUT)						
V <sub>OL</sub>	LOW level output voltage	I <sub>OL</sub> = +2 mA	0	–	0.4	V
V <sub>OH</sub>	HIGH level output voltage	I <sub>OH</sub> = –2 mA	2.4	–	V <sub>DD</sub>	V
C <sub>L</sub>	load capacitance		–	–	50	pF
DOBM (3-STATE PUSH-PULL OUTPUT)						
V <sub>OL</sub>	LOW level output voltage	I <sub>OL</sub> = +2 mA	0	–	0.4	V
V <sub>OH</sub>	HIGH level output voltage	I <sub>OH</sub> = –2 mA	2.4	–	V <sub>DD</sub>	V
C <sub>L</sub>	load capacitance		–	–	50	pF
I <sub>LI</sub>	3-state leakage current	V <sub>I</sub> = 0 to V <sub>DD</sub>	–10	–	+10	μA
<b>ANALOG SECTION (measured at V<sub>DD</sub> = 5 V; T<sub>amb</sub> = 25 °C)</b>						
<b>Demodulator analog references</b>						
V <sub>R<sub>CF</sub></sub> OUTPUT						
V <sub>o</sub>	output signal voltage	supply dependent	–	0.5V <sub>DDF2</sub>	–	V
C <sub>i</sub>	input capacitance		–	–	10	pF
V <sub>R<sub>OF</sub></sub> OUTPUT						
V <sub>o</sub>	output signal voltage	defined by V <sub>R<sub>CF</sub></sub>	–	0.5V <sub>DDF2</sub>	–	V
C <sub>i</sub>	input capacitance		–	–	10	pF

# Terrestrial digital sound decoder for conventional intercarrier PLL-IF systems

SAA7284

SYMBOL	PARAMETER	CONDITIONS	MIN.	TYP.	MAX.	UNIT
<b>I<sub>REF</sub> OUTPUT</b>						
V <sub>o</sub>	output signal voltage	defined by V <sub>RCF</sub>	–	0.5V <sub>DDF2</sub>	–	V
C <sub>i</sub>	input capacitance		–	–	10	pF
I <sub>sink</sub>	output sink current	with external 10 kΩ resistor from pin to V <sub>SSF2</sub>	–	250	–	μA
<b>Signal path analog inputs</b>						
<b>DQPSK AND MIXREF</b>						
R <sub>i</sub>	input resistance		–	12.5	–	kΩ
V <sub>IDQPSK(rms)</sub>	NICAM input signal voltage V <sub>nom</sub> (RMS value)	10 dB SAW sound shelf	–	24.5	–	mV
		14 dB SAW sound shelf	–	15.5	–	mV
V <sub>IDR</sub>	AGC range	with respect to V <sub>IDQPSK</sub> ; 10 dB SAW	+10	+10	–	dB
			–15	–20	–	dB
V <sub>IDR</sub>	AGC range	with respect to V <sub>IDQPSK</sub> ; 14 dB SAW	+10	+10	–	dB
			–11	–16	–	dB
V <sub>ICUM(rms)</sub>	cumulative input signal voltage (RMS value)	note 2	–	–	464	mV
C <sub>i</sub>	input capacitance		–	–	10	pF
<b>Baseband outputs</b>						
<b>CEYE AND SEYE</b>						
V <sub>o(p-p)</sub>	eye pattern output signal voltage (peak-to-peak value)	in-lock; system I; note 3	–	1.25	–	V
		in-lock; system B/G; note 3	–	1.79	–	V
V <sub>I/Q</sub>	channel matching	20log <sub>10</sub> (V <sub>CEYE</sub> /V <sub>SEYE</sub> )	–2	0	+2	dB
<b>COFF AND SOFF</b>						
V <sub>o</sub>	offset compensator DC output voltage	defined by V <sub>RCF</sub>	–	0.5V <sub>DDF2</sub>	–	V
<b>Baseband filters</b>						
<b>SYSTEM I</b>						
Af <sub>o</sub>	pass band cut-off attenuation	f <sub>i</sub> = 6552 MHz + 182 kHz	1.9	3.1	4.6	dB
FMr	FM rejection	f <sub>i</sub> = 6.0 MHz ± 50 kHz	–	65	–	dB
FMomr	FM rejection (overmodulated FM)	f <sub>i</sub> = 6.0 MHz ± 80 kHz	45	50	–	dB
CCr	colour-carrier rejection	f <sub>i</sub> = 4.43 MHz	70	78	–	dB



# Terrestrial digital sound decoder for conventional intercarrier PLL-IF systems

SAA7284

SYMBOL	PARAMETER	CONDITIONS	MIN.	TYP.	MAX.	UNIT
<b>SYSTEM BGH</b>						
$A_{f_0}$	pass band cut-off attenuation	$f_i = 5850 \text{ MHz} + 182 \text{ kHz}$	1.7	3.1	4.5	dB
FMr	FM rejection	$f_i = 5.5 \text{ MHz} \pm 50 \text{ kHz}$	–	50	–	dB
FMomr	FM rejection (overmodulated FM)	$f_i = 5.5 \text{ MHz} \pm 80 \text{ kHz}$	25	30	–	dB
CCr	colour-carrier rejection	$f_i = 4.43 \text{ MHz}$	66	73	–	dB
<b>Baseband demodulator output</b>						
REMO						
$V_o$	output voltage limits		0.2	–	$V_{DD} - 0.5$	V
$K_p$	carrier loop-phase detector gain	system I	–	1.2	–	V/rad
		system B/G	–	0.9	–	V/rad
$f_p$	carrier loop pull-in frequency		4	–	–	kHz
$\Phi_{\text{offset}}$	carrier loop-phase detector offset	phase shift = $45^\circ$	–4	0	+4	deg
$f_n$	carrier loop bandwidth (natural frequency)		2	–	5	kHz
<b>Baseband remodulator filter feedback</b>						
REMVE						
$V_o$	carrier loop filter virtual earth voltage	defined by $V_{RCF}$	–	$0.5V_{DDF2}$	–	V
<b>Fine frequency calibration current (on to REMVE node)</b>						
$I_{\text{source}}$	output source current		–	15	–	$\mu\text{A}$
$I_{\text{sink}}$	output sink current		–	15	–	$\mu\text{A}$
$I_{\text{LI}}$	3-state leakage current		–0.25	0	+0.25	$\mu\text{A}$
$f_{\text{step}}$	fine frequency calibration step		0.8	2	8	kHz
<b>Voltage controlled oscillator</b>						
VCONT						
$V_i$	input signal voltage		0.5	–	$V_{DD} - 0.5$	V
$C_i$	input capacitance		–	–	10	pF
VCO (MEASURED AT $V_{\text{CLK}}$ PIN)						
$f_{\text{VCO}}$	VCO frequency after DAC calibration	$f_{\text{SYS}} = 6552 \text{ MHz}$ (system I) or	$f_{\text{SYS}} - 75$	–	$f_{\text{SYS}} + 75$	kHz
	VCO frequency after fine frequency calibration	$f_{\text{SYS}} = 5.85 \text{ MHz}$ (system BGH)	$f_{\text{SYS}} - 4$	–	$f_{\text{SYS}} + 4$	kHz
$K_{\text{VCO}}$	VCO slope	system I	–139	–186	–232	kHz/V
		system B/G	–191	–255	–319	kHz/V
$\text{DAC}_{\text{STEP}}$	VCO calibrating DAC step size		–50	+30	+50	kHz
$I_{\text{toQ}}$	in-phase to quadrature phase accuracy		–	90	–	deg
$\phi_j$	VCO phase jitter	note 4	–	–	8.1	ns

# Terrestrial digital sound decoder for conventional intercarrier PLL-IF systems

SAA7284

SYMBOL	PARAMETER	CONDITIONS	MIN.	TYP.	MAX.	UNIT
<b>Clock recovery loop and crystal oscillator</b>						
XTAL						
$C_i$	input capacitance		–	–	10	pF
$V_{bias}$	DC bias voltage		–	3.63	–	V
OSC						
$V_{osc(p-p)}$	oscillator voltage amplitude (peak to peak value)		–	1.4	–	V
$V_{bias}$	DC bias voltage		–	2.33	–	V
$G_v$	small signal voltage gain		–	1.0	–	V/V
$C_o$	output capacitance		–	–	10	pF
CRYSTAL SPECIFICATION (FUNDAMENTAL MODE)						
$f_i$	crystal input frequency		–	8.192	–	MHz
$C_L$	load capacitance		–	15	–	pF
$C_1$	series capacitance		21	–	–	fF
$C_0$	parallel capacitance		–	–	5	pF
$S$	pulling sensitivity	determined by $C_L$ , $C_1$ and $C_0$	–26.25	–	–	$10^{-6}/pF$
$R_r$	resonance resistance		–	–	40	$\Omega$
$R_{DLD}$	resonance resistance; drive level dependency		–	–	120	$\Omega$
$X_a$	ageing		–	–	$\pm 5$	$10^{-6}/year$
$T_{range}$	temperature range		–20	+25	+70	$^{\circ}C$
$X_j$	adjustment tolerance		–	–	$\pm 30$	$10^{-6}$
$X_d$	drift	across $T_{range}$	–	–	$\pm 30$	$10^{-6}$
CLOCK RECOVERY LOOP CURRENT SOURCE (CLKLPF)						
$I_{LI}$	3-state leakage current at $\pi/2$ phase shift	$0.5 \leq V_{CLKLPF} \leq$ $V_{DD} - 0.5$ ; note 5	–5	0	+5	$\mu A$
$\phi_{gm}$	phase comparator transconductance	$0.5 \leq V_{CLKLPF} \leq$ $V_{DD} - 0.5$ ; note 5	57	63.5	70	$\mu A/rad$
<b>Analog references</b>						
$V_{RCA}$ OUTPUT						
$V_O$	output signal voltage	supply dependent	–	$0.5V_{DDA}$	–	V
$C_i$	input capacitance		–	–	10	pF
$V_{ROA}$ OUTPUT						
$V_O$	output signal voltage	defined by $V_{RCA}$	–	$0.5V_{DDA}$	–	V
$C_i$	input capacitance		–	–	10	pF
<b>Digital filter</b>						
$f_s$	output sample frequency		–	128	–	kHz
PR	pass band ripple	at 0 Hz to 15 kHz	–	–	$\pm 0.01$	dB
SBA	stop band attenuation	at $f \geq 17$ kHz	30	–	–	dB

# Terrestrial digital sound decoder for conventional intercarrier PLL-IF systems

SAA7284

SYMBOL	PARAMETER	CONDITIONS	MIN.	TYP.	MAX.	UNIT
<b>Digital de-emphasis</b>						
DEV	deviation from ideal		–	–	±0.09	dB
<b>FM audio inputs</b>						
FML AND FMR (SELECTED VIA I <sup>2</sup> C-BUS CONTROL)						
Z <sub>i</sub>	input impedance	0 dB FM attenuation set	–	40	–	kΩ
		–12 dB FM attenuation set	–	160	–	kΩ
G	output gain	programmable in 1 dB steps	–	0 to 12	–	dB
G <sub>a</sub>	output gain accuracy		–0.5	0	+0.5	dB
V <sub>ain(rms)</sub>	input voltage level (RMS value)		–	–	1.1	V
S/N	signal-to-noise ratio		90	95	–	dB
THD	total harmonic distortion		–	–85	–70	dB
<b>EXT audio input</b>						
EXTL AND EXTR (SELECTED VIA I <sup>2</sup> C-BUS CONTROL)						
Z <sub>i</sub>	input impedance		–	40	–	kΩ
G	output gain		–	0	–	dB
G <sub>a</sub>	output gain accuracy		–	0	–	dB
V <sub>ain(rms)</sub>	input voltage level (RMS value)		–	–	1.1	V
S/N	signal-to-noise ratio		90	95	–	dB
THD	total harmonic distortion		–	–85	–70	dB
<b>NICAM internal DAC (selected via I<sup>2</sup>C-bus control)</b>						
V <sub>o(rms)</sub>	NICAM output voltage level (RMS value)	0 dB; V <sub>ROA</sub> = 2.5 V	0.94	1	1.06	V
THD+N	total harmonic distortion plus noise	notes 6 and 7	–	–80	–75	dB
DIGS	digital silence level	MUTE on	–	–80	–	dB
AUDIOS	audio silence level	SILENCE on = 0	–80	–	–	dB
<b>Audio outputs</b>						
OPL AND OPR						
C <sub>L</sub>	output load capacitance		–	–	300	pF
R <sub>L</sub>	output load resistance		3	–	–	kΩ
CHM	channel matching	0 dB, 1 kHz	–0.5	0	+0.5	dB
PSRR	power supply rejection ratio		–	40	–	dB

# Terrestrial digital sound decoder for conventional intercarrier PLL-IF systems

SAA7284

SYMBOL	PARAMETER	CONDITIONS	MIN.	TYP.	MAX.	UNIT
<b>Timing (all timing values refer to <math>V_{IH}</math> and <math>V_{IL}</math> levels)</b>						
DATAIN WITH RESPECT TO PCLK (see Fig.9)						
$t_{SU;DAT}$	data set-up time		100	–	–	ns
$t_{HD;DAT}$	data hold time		250	–	–	ns
SDA WITH RESPECT TO SCL(see Fig.10)						
$f_{SCL}$	SCL clock frequency		0	–	400	kHz
$t_{BUF}$	bus free time		1300	–	–	ns
$t_{HD;STA}$	START code hold time		600	–	–	ns
$t_{LOW}$	SCL clock LOW time		1300	–	–	ns
$t_{HIGH}$	SCL clock HIGH time		600	–	–	ns
$t_{SU;STA}$	START code set-up time		600	–	–	ns
$t_{HD;DAT}$	data hold time	note 8	0	–	–	ns
$t_{SU;DAT}$	data set-up time	note 9	100	–	–	ns
$t_r$	SDA and SCL rise time		50	–	300	ns
$t_f$	SDA and SCL fall time		50	–	300	ns
$t_{SU;STO}$	STOP code set-up time		600	–	–	ns

## Notes

1. It is assumed that all supplies are externally connected at the same source, and consequently that maximum and minimum values apply simultaneously to each supply.
2. Cumulative input level based on FM at 0 dB and NICAM at –10 dB with respect to picture carrier.
3. The signal amplitude present at the SEYE and CEYE pins depends on whether the demodulator is in or out-of-lock. When out-of-lock, the signal at the pins is  $\sqrt{2}$  times the in-lock situation.
4. VCO jitter is measured in System I over 100 cycles of the VCO clock.
5. With 10 k $\Omega$  resistor from  $I_{REF}$  to  $V_{SSF2}$ .
6. Audio performance is limited by the dynamic range of the NICAM 728 system. Due to compansion, the quantization noise is never lower than –62 dB with respect to the input level.
7. Measured with a –30 dB, 1 kHz NICAM 728 input signal.
8. Note that a transmitter must internally provide at least a hold time to bridge the undefined region (max. 300 ns) of the falling edge of SCL.
9. If a fast I<sup>2</sup>C-bus device is used in an up to 100 kbit/s I<sup>2</sup>C-bus system, then the requirement  $t_{SU;DAT} \geq 250$  ns is always fulfilled if this device cannot stretch the LOW level of the SCL signal. If a device stretches the LOW level of the SCL signal, then data to SDA must be asserted ( $t_{RD(max)} + t_{SU;DAT}$ ) = 1000 + 250 = 1250 ns before the SCL signal is released to be compatible with the up to 100 kbit/s I<sup>2</sup>C-bus specification.

Terrestrial digital sound decoder for  
conventional intercarrier PLL-IF systems

SAA7284

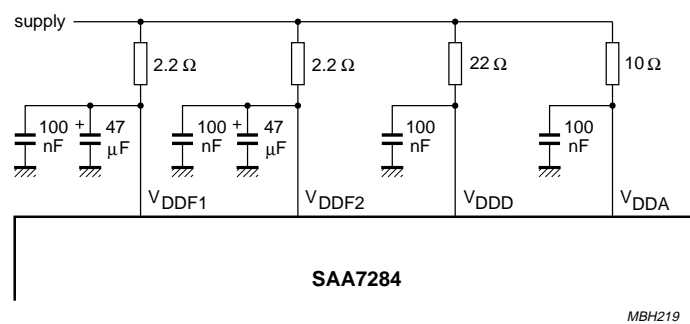
Fig.7 V<sub>DD</sub> external circuitry.

Terrestrial digital sound decoder for conventional intercarrier PLL-IF systems

SAA7284

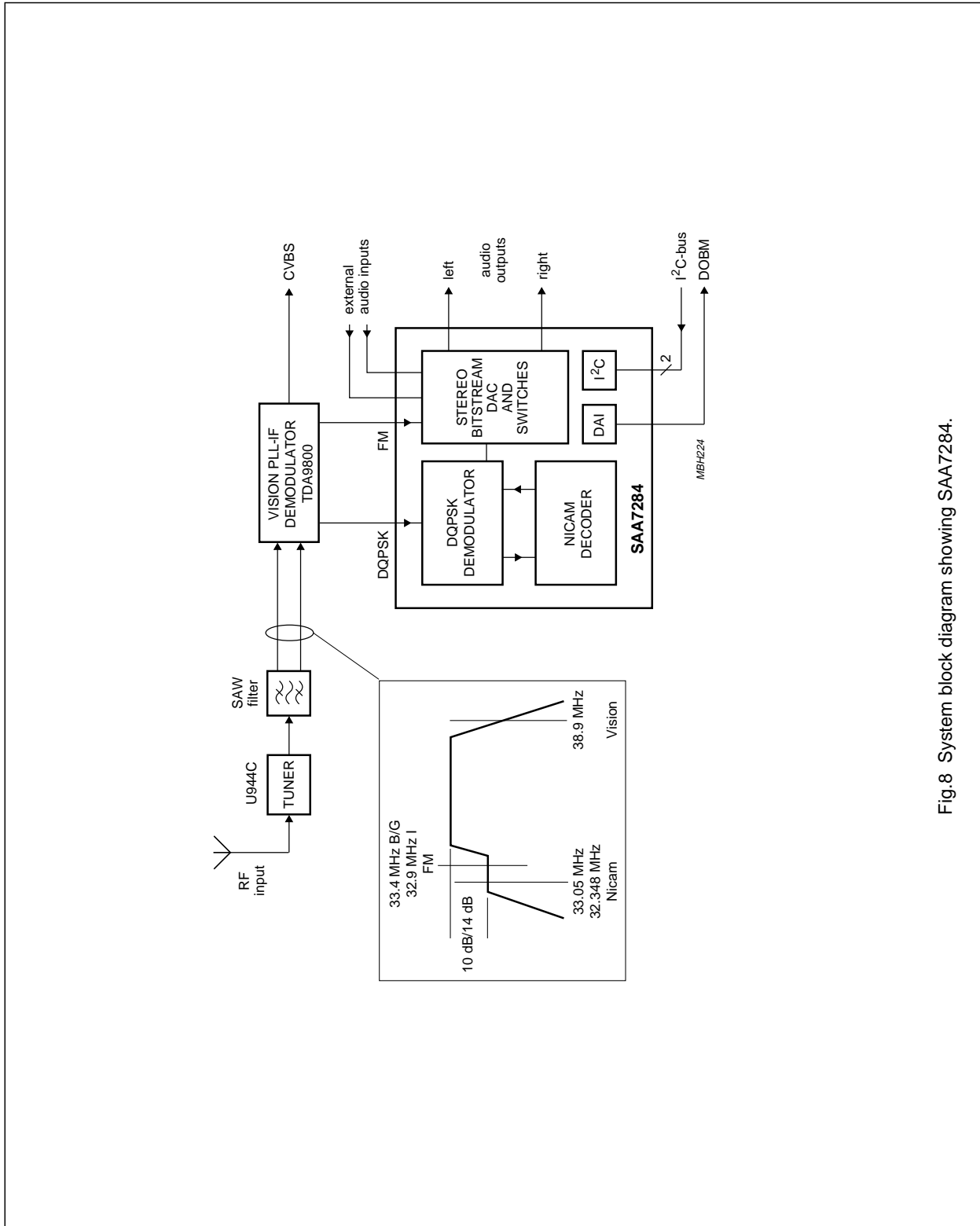

Fig.8 System block diagram showing SAA7284.

# Terrestrial digital sound decoder for conventional intercarrier PLL-IF systems

SAA7284

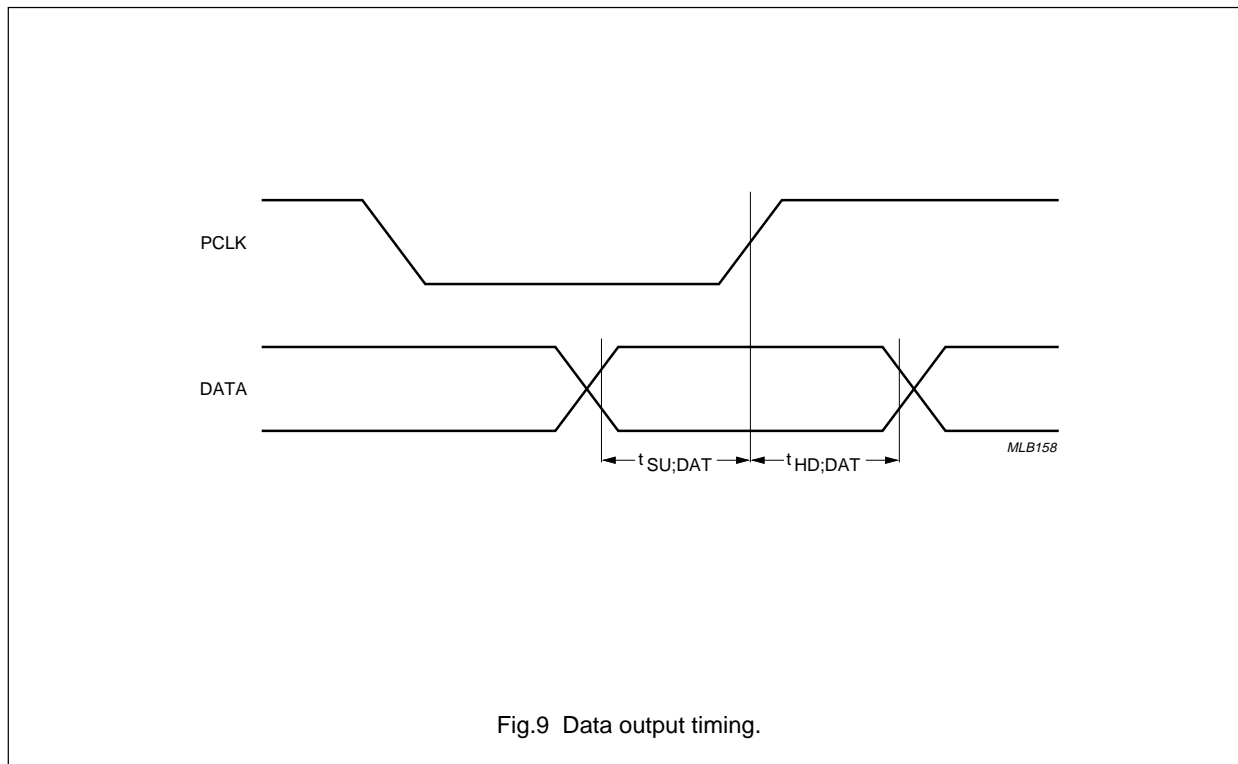

Fig.9 Data output timing.

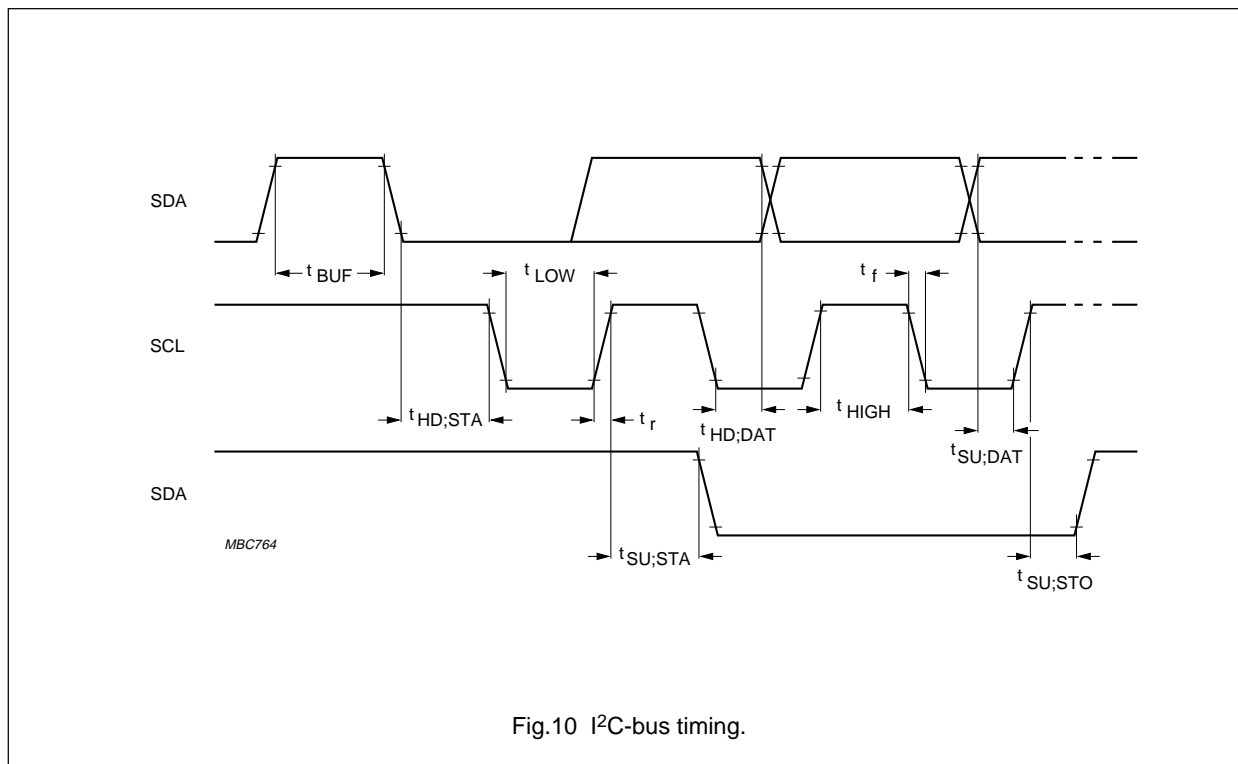

Fig.10 I<sup>2</sup>C-bus timing.

# Terrestrial digital sound decoder for conventional intercarrier PLL-IF systems

SAA7284

## APPLICATION INFORMATION

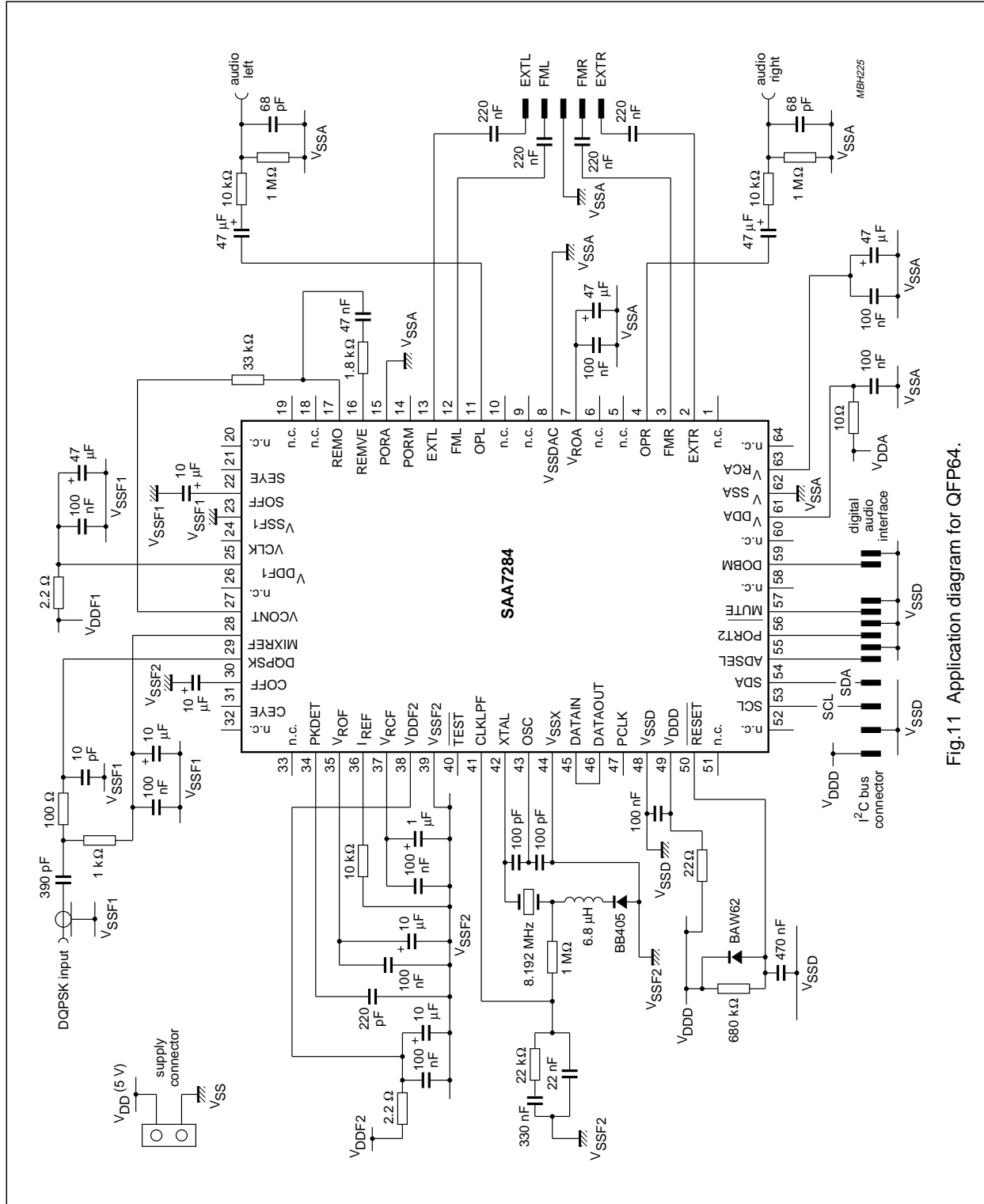

Fig.11 Application diagram for QFP64.



# Terrestrial digital sound decoder for conventional intercarrier PLL-IF systems

SAA7284

## PACKAGE OUTLINES

SDIP52: plastic shrink dual in-line package; 52 leads (600 mil)

SOT247-1

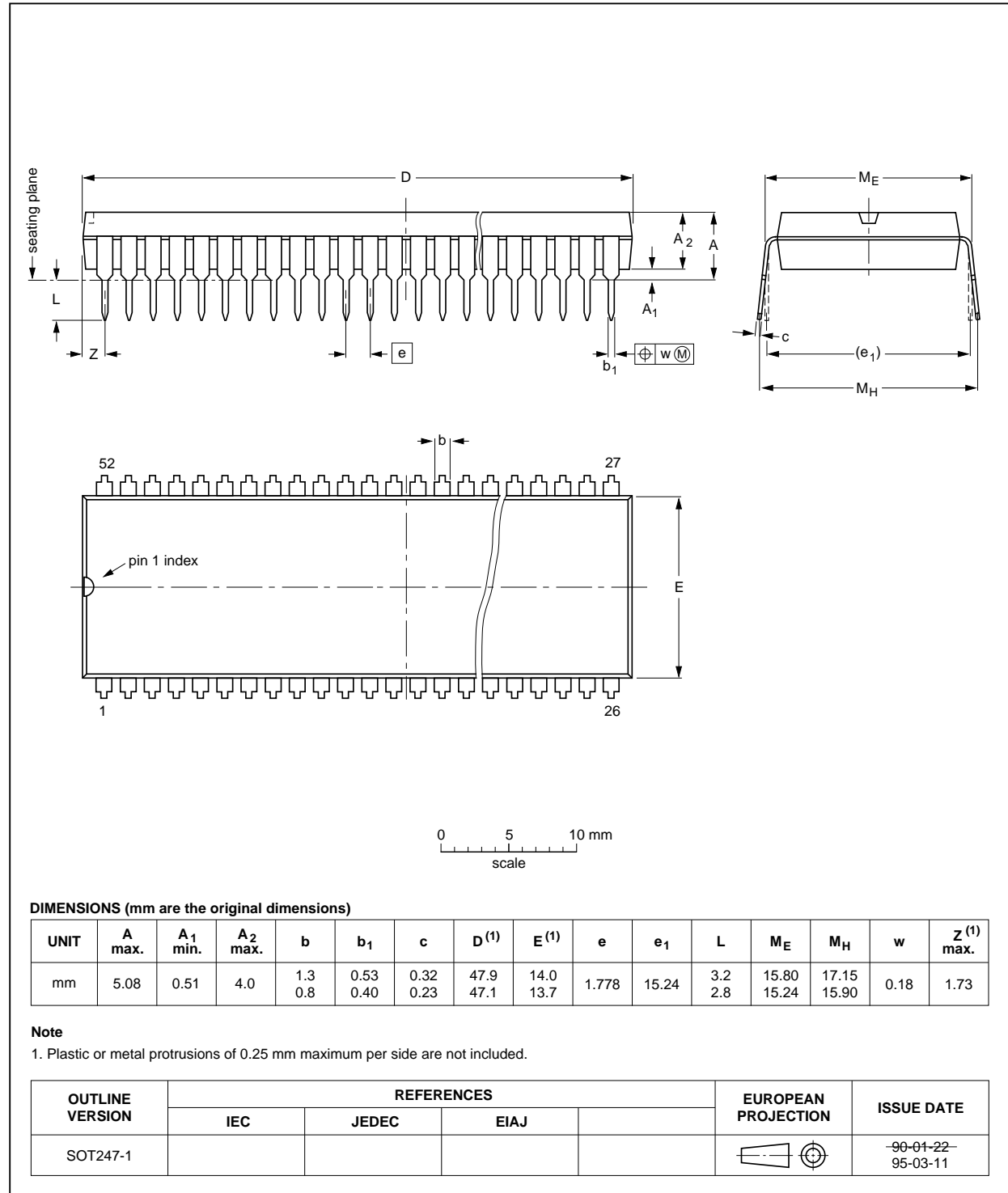

# Terrestrial digital sound decoder for conventional intercarrier PLL-IF systems

## SAA7284

QFP64: plastic quad flat package; 64 leads (lead length 1.95 mm); body 14 x 20 x 2.8 mm

SOT319-2

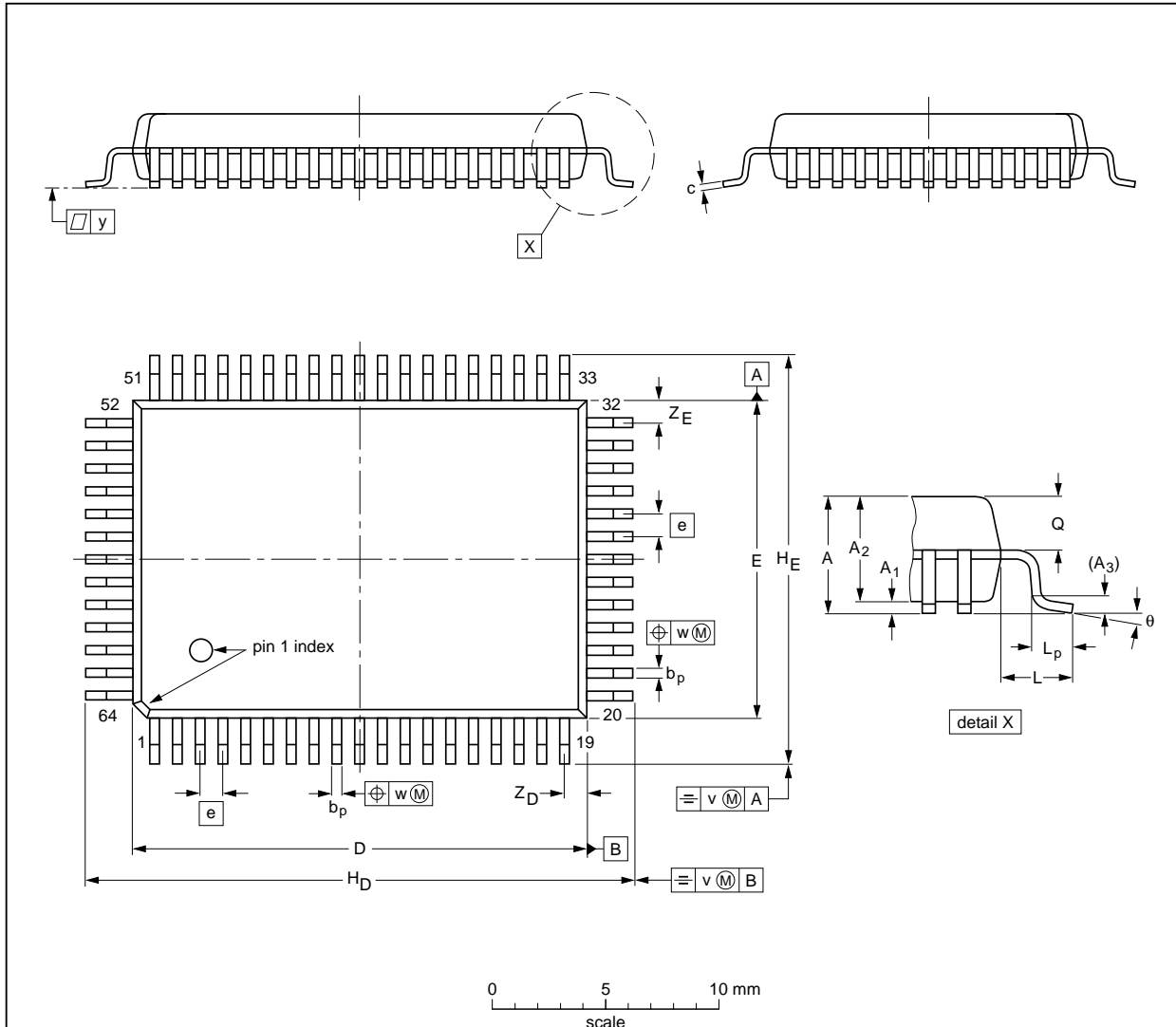

**DIMENSIONS (mm are the original dimensions)**

UNIT	A max.	A <sub>1</sub>	A <sub>2</sub>	A <sub>3</sub>	b <sub>p</sub>	c	D <sup>(1)</sup>	E <sup>(1)</sup>	e	H <sub>D</sub>	H <sub>E</sub>	L	L <sub>p</sub>	Q	v	w	y	Z <sub>D</sub> <sup>(1)</sup>	Z <sub>E</sub> <sup>(1)</sup>	θ
mm	3.20	0.25 0.05	2.90 2.65	0.25	0.50 0.35	0.25 0.14	20.1 19.9	14.1 13.9	1	24.2 23.6	18.2 17.6	1.95	1.0 0.6	1.4 1.2	0.2	0.2	0.1	1.2 0.8	1.2 0.8	7° 0°

**Note**

1. Plastic or metal protrusions of 0.25 mm maximum per side are not included.

OUTLINE VERSION	REFERENCES				EUROPEAN PROJECTION	ISSUE DATE
	IEC	JEDEC	EIAJ			
SOT319-2						92-11-17- 95-02-04

## Terrestrial digital sound decoder for conventional intercarrier PLL-IF systems

SAA7284

### SOLDERING

#### Introduction

There is no soldering method that is ideal for all IC packages. Wave soldering is often preferred when through-hole and surface mounted components are mixed on one printed-circuit board. However, wave soldering is not always suitable for surface mounted ICs, or for printed-circuits with high population densities. In these situations reflow soldering is often used.

This text gives a very brief insight to a complex technology. A more in-depth account of soldering ICs can be found in our *"IC Package Databook"* (order code 9398 652 90011).

#### SDIP

##### SOLDERING BY DIPPING OR BY WAVE

The maximum permissible temperature of the solder is 260 °C; solder at this temperature must not be in contact with the joint for more than 5 seconds. The total contact time of successive solder waves must not exceed 5 seconds.

The device may be mounted up to the seating plane, but the temperature of the plastic body must not exceed the specified maximum storage temperature ( $T_{stg\ max}$ ). If the printed-circuit board has been pre-heated, forced cooling may be necessary immediately after soldering to keep the temperature within the permissible limit.

##### REPAIRING SOLDERED JOINTS

Apply a low voltage soldering iron (less than 24 V) to the lead(s) of the package, below the seating plane or not more than 2 mm above it. If the temperature of the soldering iron bit is less than 300 °C it may remain in contact for up to 10 seconds. If the bit temperature is between 300 and 400 °C, contact may be up to 5 seconds.

#### QFP

##### REFLOW SOLDERING

Reflow soldering techniques are suitable for all QFP packages.

The choice of heating method may be influenced by larger plastic QFP packages (44 leads, or more). If infrared or vapour phase heating is used and the large packages are not absolutely dry (less than 0.1% moisture content by weight), vaporization of the small amount of moisture in them can cause cracking of the plastic body. For more information, refer to the Drypack chapter in our *"Quality Reference Handbook"* (order code 9397 750 00192).

Reflow soldering requires solder paste (a suspension of fine solder particles, flux and binding agent) to be applied to the printed-circuit board by screen printing, stencilling or pressure-syringe dispensing before package placement.

Several techniques exist for reflowing; for example, thermal conduction by heated belt. Dwell times vary from 50 to 300 seconds depending on heating method. Typical reflow temperatures range from 215 to 250 °C.

Preheating is necessary to dry the paste and evaporate the binding agent. Preheat for 45 minutes at 45 °C.

##### WAVE SOLDERING

Wave soldering is **not** recommended for QFP packages. This is because of the likelihood of solder bridging due to closely-spaced leads and the possibility of incomplete solder penetration in multi-lead devices.

#### If wave soldering cannot be avoided, the following conditions must be observed:

- **A double-wave (a turbulent wave with high upward pressure followed by a smooth laminar wave) soldering technique should be used.**
- **The footprint must be at an angle of 45° to the board direction and must incorporate solder thieves downstream and at the side corners.**

**Even with these conditions, do not consider wave soldering the following packages: QFP52 (SOT379-1), QFP100 (SOT317-1), QFP100 (SOT317-2), QFP100 (SOT382-1) or QFP160 (SOT322-1).**

During placement and before soldering, the package must be fixed with a droplet of adhesive. The adhesive can be applied by screen printing, pin transfer or syringe dispensing. The package can be soldered after the adhesive is cured. Maximum permissible solder temperature is 260 °C, and maximum duration of package immersion in solder is 10 seconds, if cooled to less than 150 °C within 6 seconds. Typical dwell time is 4 seconds at 250 °C.

A mildly-activated flux will eliminate the need for removal of corrosive residues in most applications.

##### REPAIRING SOLDERED JOINTS

Fix the component by first soldering two diagonally-opposite end leads. Use only a low voltage soldering iron (less than 24 V) applied to the flat part of the lead. Contact time must be limited to 10 seconds at up to 300 °C. When using a dedicated tool, all other leads can be soldered in one operation within 2 to 5 seconds between 270 and 320 °C.

## Terrestrial digital sound decoder for conventional intercarrier PLL-IF systems

SAA7284

### DEFINITIONS

<b>Data sheet status</b>	
Objective specification	This data sheet contains target or goal specifications for product development.
Preliminary specification	This data sheet contains preliminary data; supplementary data may be published later.
Product specification	This data sheet contains final product specifications.
<b>Limiting values</b>	
Limiting values given are in accordance with the Absolute Maximum Rating System (IEC 134). Stress above one or more of the limiting values may cause permanent damage to the device. These are stress ratings only and operation of the device at these or at any other conditions above those given in the Characteristics sections of the specification is not implied. Exposure to limiting values for extended periods may affect device reliability.	
<b>Application information</b>	
Where application information is given, it is advisory and does not form part of the specification.	

### LIFE SUPPORT APPLICATIONS

These products are not designed for use in life support appliances, devices, or systems where malfunction of these products can reasonably be expected to result in personal injury. Philips customers using or selling these products for use in such applications do so at their own risk and agree to fully indemnify Philips for any damages resulting from such improper use or sale.

### PURCHASE OF PHILIPS I<sup>2</sup>C COMPONENTS



Purchase of Philips I<sup>2</sup>C components conveys a license under the Philips' I<sup>2</sup>C patent to use the components in the I<sup>2</sup>C system provided the system conforms to the I<sup>2</sup>C specification defined by Philips. This specification can be ordered using the code 9398 393 40011.

---

Terrestrial digital sound decoder for  
conventional intercarrier PLL-IF systems

---

SAA7284

**NOTES**

---

Terrestrial digital sound decoder for  
conventional intercarrier PLL-IF systems

---

SAA7284

**NOTES**

---

Terrestrial digital sound decoder for  
conventional intercarrier PLL-IF systems

---

SAA7284

**NOTES**

# Philips Semiconductors – a worldwide company

**Argentina:** see South America

**Australia:** 34 Waterloo Road, NORTH RYDE, NSW 2113,  
Tel. +61 2 9805 4455, Fax. +61 2 9805 4466

**Austria:** Computerstr. 6, A-1101 WIEN, P.O. Box 213,  
Tel. +43 1 60 101, Fax. +43 1 60 101 1210

**Belarus:** Hotel Minsk Business Center, Bld. 3, r. 1211, Volodarski Str. 6,  
220050 MINSK, Tel. +375 172 200 733, Fax. +375 172 200 773

**Belgium:** see The Netherlands

**Brazil:** see South America

**Bulgaria:** Philips Bulgaria Ltd., Energoproject, 15th floor,  
51 James Bourchier Blvd., 1407 SOFIA,  
Tel. +359 2 689 211, Fax. +359 2 689 102

**Canada:** PHILIPS SEMICONDUCTORS/COMPONENTS,  
Tel. +1 800 234 7381

**China/Hong Kong:** 501 Hong Kong Industrial Technology Centre,  
72 Tat Chee Avenue, Kowloon Tong, HONG KONG,  
Tel. +852 2319 7888, Fax. +852 2319 7700

**Colombia:** see South America

**Czech Republic:** see Austria

**Denmark:** Prags Boulevard 80, PB 1919, DK-2300 COPENHAGEN S,  
Tel. +45 32 88 2636, Fax. +45 31 57 1949

**Finland:** Sinikalliontie 3, FIN-02630 ESPOO,  
Tel. +358 9 615800, Fax. +358 9 61580/xxx

**France:** 4 Rue du Port-aux-Vins, BP317, 92156 SURESNES Cedex,  
Tel. +33 1 40 99 6161, Fax. +33 1 40 99 6427

**Germany:** Hammerbrookstraße 69, D-20097 HAMBURG,  
Tel. +49 40 23 53 60, Fax. +49 40 23 536 300

**Greece:** No. 15, 25th March Street, GR 17778 TAVROS/ATHENS,  
Tel. +30 1 4894 339/239, Fax. +30 1 4814 240

**Hungary:** see Austria

**India:** Philips INDIA Ltd, Shivsagar Estate, A Block, Dr. Annie Besant Rd.  
Worli, MUMBAI 400 018, Tel. +91 22 4938 541, Fax. +91 22 4938 722

**Indonesia:** see Singapore

**Ireland:** Newstead, Clonskeagh, DUBLIN 14,  
Tel. +353 1 7640 000, Fax. +353 1 7640 200

**Israel:** RAPAC Electronics, 7 Kehilat Saloniki St, TEL AVIV 61180,  
Tel. +972 3 645 0444, Fax. +972 3 649 1007

**Italy:** PHILIPS SEMICONDUCTORS, Piazza IV Novembre 3,  
20124 MILANO, Tel. +39 2 6752 2531, Fax. +39 2 6752 2557

**Japan:** Philips Bldg 13-37, Kohnan 2-chome, Minato-ku, TOKYO 108,  
Tel. +81 3 3740 5130, Fax. +81 3 3740 5077

**Korea:** Philips House, 260-199 Itaewon-dong, Yongsan-ku, SEOUL,  
Tel. +82 2 709 1412, Fax. +82 2 709 1415

**Malaysia:** No. 76 Jalan Universiti, 46200 PETALING JAYA, SELANGOR,  
Tel. +60 3 750 5214, Fax. +60 3 757 4880

**Mexico:** 5900 Gateway East, Suite 200, EL PASO, TEXAS 79905,  
Tel. +9-5 800 234 7381

**Middle East:** see Italy

**Netherlands:** Postbus 90050, 5600 PB EINDHOVEN, Bldg. VB,  
Tel. +31 40 27 82785, Fax. +31 40 27 88399

**New Zealand:** 2 Wagener Place, C.P.O. Box 1041, AUCKLAND,  
Tel. +64 9 849 4160, Fax. +64 9 849 7811

**Norway:** Box 1, Manglerud 0612, OSLO,  
Tel. +47 22 74 8000, Fax. +47 22 74 8341

**Philippines:** Philips Semiconductors Philippines Inc.,  
106 Valero St. Salcedo Village, P.O. Box 2108 MCC, MAKATI,  
Metro MANILA, Tel. +63 2 816 6380, Fax. +63 2 817 3474

**Poland:** Ul. Lukiska 10, PL 04-123 WARSZAWA,  
Tel. +48 22 612 2831, Fax. +48 22 612 2327

**Portugal:** see Spain

**Romania:** see Italy

**Russia:** Philips Russia, Ul. Usatcheva 35A, 119048 MOSCOW,  
Tel. +7 095 247 9145, Fax. +7 095 247 9144

**Singapore:** Lorong 1, Toa Payoh, SINGAPORE 1231,  
Tel. +65 350 2538, Fax. +65 251 6500

**Slovakia:** see Austria

**Slovenia:** see Italy

**South Africa:** S.A. PHILIPS Pty Ltd., 195-215 Main Road Martindale,  
2092 JOHANNESBURG, P.O. Box 7430 Johannesburg 2000,  
Tel. +27 11 470 5911, Fax. +27 11 470 5494

**South America:** Rua do Rocio 220, 5th floor, Suite 51,  
04552-903 São Paulo, SÃO PAULO - SP, Brazil,  
Tel. +55 11 821 2333, Fax. +55 11 829 1849

**Spain:** Balmes 22, 08007 BARCELONA,  
Tel. +34 3 301 6312, Fax. +34 3 301 4107

**Sweden:** Kottbygatan 7, Akalla, S-16485 STOCKHOLM,  
Tel. +46 8 632 2000, Fax. +46 8 632 2745

**Switzerland:** Allmendstrasse 140, CH-8027 ZÜRICH,  
Tel. +41 1 488 2686, Fax. +41 1 481 7730

**Taiwan:** PHILIPS TAIWAN Ltd., 23-30F, 66,  
Chung Hsiao West Road, Sec. 1, P.O. Box 22978,  
TAIPEI 100, Tel. +886 2 382 4443, Fax. +886 2 382 4444

**Thailand:** PHILIPS ELECTRONICS (THAILAND) Ltd.,  
209/2 Sanpavuth-Bangna Road Prakanong, BANGKOK 10260,  
Tel. +66 2 745 4090, Fax. +66 2 398 0793

**Turkey:** Talatpasa Cad. No. 5, 80640 GÜLTEPE/ISTANBUL,  
Tel. +90 212 279 2770, Fax. +90 212 282 6707

**Ukraine:** PHILIPS UKRAINE, 4 Patrice Lumumba str., Building B, Floor 7,  
252042 KIEV, Tel. +380 44 264 2776, Fax. +380 44 268 0461

**United Kingdom:** Philips Semiconductors Ltd., 276 Bath Road, Hayes,  
MIDDLESEX UB3 5BX, Tel. +44 181 730 5000, Fax. +44 181 754 8421

**United States:** 811 East Arques Avenue, SUNNYVALE, CA 94088-3409,  
Tel. +1 800 234 7381

**Uruguay:** see South America

**Vietnam:** see Singapore

**Yugoslavia:** PHILIPS, Trg N. Pasica 5/v, 11000 BEOGRAD,  
Tel. +381 11 625 344, Fax. +381 11 635 777

**For all other countries apply to:** Philips Semiconductors, Marketing & Sales Communications,  
Building BE-p, P.O. Box 218, 5600 MD EINDHOVEN, The Netherlands, Fax. +31 40 27 24825

**Internet:** <http://www.semiconductors.philips.com>

© Philips Electronics N.V. 1996

SCA52

All rights are reserved. Reproduction in whole or in part is prohibited without the prior written consent of the copyright owner.

The information presented in this document does not form part of any quotation or contract, is believed to be accurate and reliable and may be changed without notice. No liability will be accepted by the publisher for any consequence of its use. Publication thereof does not convey nor imply any license under patent- or other industrial or intellectual property rights.

Printed in The Netherlands

537021/1200/01/pp40

Date of release: 1996 Oct 24

Document order number: 9397 750 01426

*Let's make things better.*

**Philips  
Semiconductors**



**PHILIPS**