



High Speed, Fast Settling IC Op Amp

AD509

FEATURES

Fast Settling Time

- ~0.1% in 500ns max
- 0.01% in 2.5 μ s max

High Slew Rate: 100V/ μ s min

Low I_{OS} : 25nA max

Guaranteed V_{OS} Drift: 30 μ V/ $^{\circ}$ C max

High CMRR: 80dB min

Drives 500pF

Low Price

APPLICATIONS

- D/A and A/D Conversion
- Wideband Amplifiers
- Multiplexers
- Pulse Amplifiers

PRODUCT DESCRIPTION

The AD509J, AD509K and AD509S are monolithic operational amplifiers specifically designed for applications requiring fast settling times to high accuracy. Other comparable dynamic parameters include a small signal bandwidth of 20MHz, slew rate of 100V/ μ s min and a full power response of 150kHz min. The devices are internally compensated for all closed loop gains greater than 3, and are compensated with a single capacitor for lower gains.

The input characteristics of the AD509 are consistent with 0.01% accuracy over limited temperature ranges; offset current is 25nA max, offset voltage is 8mV max, nullable to zero, and offset voltage drift is limited to 30 μ V/ $^{\circ}$ C max. PSRR and CMRR are typically 90dB.

The AD509 is designed for use with high speed D/A or A/D converters where the minimum conversion time is limited by the amplifier settling time. If 0.01% accuracy of conversion is required, a conversion cannot be made in a shorter period than the time required for the amplifier to settle to within 0.01% of its final value.

All devices are supplied in the TO-99 package. The AD509J and AD509K are specified for 0 to +70 $^{\circ}$ C temperature range; the AD509S for operation from -55 $^{\circ}$ C to +125 $^{\circ}$ C.

PIN CONFIGURATION

TO-99

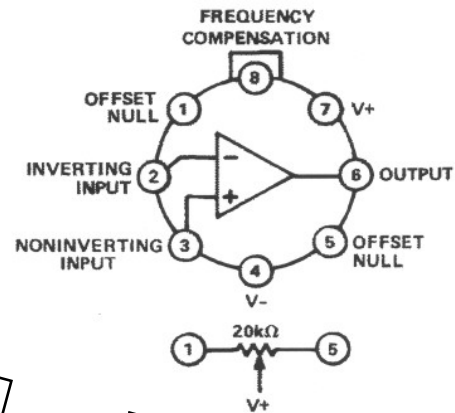

TOP VIEW

PRODUCT HIGHLIGHTS

1. The AD509 is internally compensated for all closed loop gains above 3, and compensated with a single capacitor for lower gains thus eliminating the elaborate stabilizing techniques required by other high speed IC op amps.
2. The AD509 will drive capacitive loads of 500pF without deterioration in settling time. Larger capacitive loads can be driven by tailoring the compensation to minimize settling time.
3. Common Mode Rejection, Gain and Noise are compatible with a 0.01% accuracy device.
4. The AD509K and AD509S are 100% tested for minimum slew rate and guaranteed to settle to 0.01% of its final value in less than 2.5 μ s.

AD509 — SPECIFICATIONS (@ ±25°C and V_S = ±15V dc unless otherwise specified)

Model	AD509J			AD509K			AD509S			Units
	Min	Typ	Max	Min	Typ	Max	Min	Typ	Max	
OPEN LOOP GAIN V _O = ±10V, R _L = 2kΩ T _{min} to T _{max} , R _L = 2kΩ	7,500 5,000	15,000		10,000 7,500	15,000		10,000 7,500	15,000		V/V V/V
OUTPUT CHARACTERISTICS Voltage @ R _L = 2kΩ, T _{min} to T _{max}	±10	±12		±10	±12		±10	±12		V
FREQUENCY RESPONSE Unity Gain Small Signal Full Power Response Slew Rate, Unity Gain Settling Time to 0.1% to 0.01%		20 1.2 80 200 1.0			20 1.5 80 200 1.0			20 1.5 100 200 1.0		MHz MHz V/μs ms μs
INPUT OFFSET VOLTAGE Initial Offset Input Offset Voltage T _{min} to T _{max} Input Offset Voltage vs. Supply, T _{min} to T _{max}		5 14 200			4 11 100			4 11 100		mV mV μV/V
INPUT BIAS CURRENT Initial T _{min} to T _{max}		125 250 500			100 200 400			100 200 400		nA nA
INPUT OFFSET CURRENT Initial T _A = min to max		20 50 100			10 25 50			10 25 50		nA nA
INPUT IMPEDANCE Differential	40	100		50	100		50	100		MΩ
INPUT VOLTAGE RANGE Differential Common Mode Common Mode Rejection		±15 ±10 74			±15 ±10 80			±15 ±10 80		V V dB
INPUT NOISE VOLTAGE f = 10Hz f = 100Hz f = 100kHz		100 30 19			100 30 19			100 30 19		nV/√Hz nV/√Hz nV/√Hz
POWER SUPPLY Rated Performance Operating Quiescent Current		±15 ±5 4			±15 ±5 4			±15 ±5 4		V V mA
TEMPERATURE RANGE Operating, Rated Performance Storage	0 -65	+70 +150		0 -65	+70 +150		-55 -65	+125 +150		°C °C

NOTES

Specifications subject to change without notice.

All min and max specifications are guaranteed.

Specifications shown in boldface are tested on all production units at final electrical test. Results from those tests are used to calculate outgoing quality levels.

ORDERING GUIDE

Model	Temperature Range	Package Option*
AD509JH	0°C to +70°C	H-08A
AD509KH	0°C to +70°C	H-08A
AD509SH	-55°C to +125°C	H-08A

*H-08A = TO-99 Style Metal Can. For outline information see Package Information section.

Applying the AD509

APPLYING THE AD509

MEASURING SETTLING TIME. Settling time is defined as that period required for an amplifier output to swing from 0 volts to full scale, usually 10 volts, and to settle to within a specified percentage of the final output voltage. For high accuracy systems, the accuracy requirement is normally specified as either 0.1% (10-bit accuracy) or 0.01% (12-bit accuracy) of the 10 volt output level. The settling time period is comprised of an initial propagation delay, an additional time for the amplifier to slew to the vicinity of 10 volts, and a final time period to recover from internal saturation and other effects, and settle within the specified error band. Because settling time depends on both linear and nonlinear factors, there is no simple approach to predicting its final value to different levels of accuracy. In particular, extremely high slew rates do not assure a rapid settling time, since this is only one of many factors affecting settling time. In most high speed amplifiers, after the amplifier has slewed to the vicinity of the final output voltage, it must recover from internal saturation and then allow any overshoot and ringing to damp out. These definitions are illustrated in Figure 1.

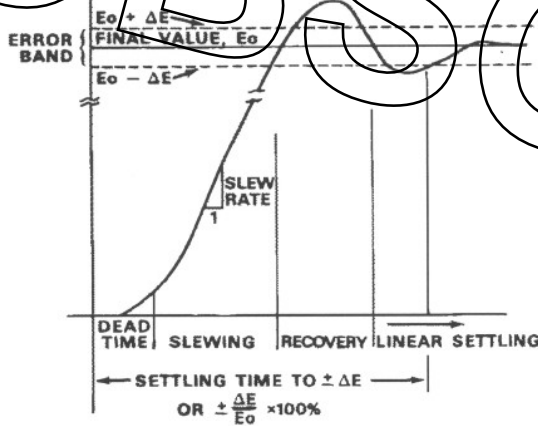

Figure 1. Settling Time

The AD509K and AD509S are guaranteed to settle to 0.1% in 500ns and 0.01% in 2.5µs when tested as shown in Figure 2. There is no appreciable degradation in settling time when the capacitive load is increased to 500pF, as discussed below. The settling time is computed by summing the output and the input into a differential amplifier, which then drives a scope

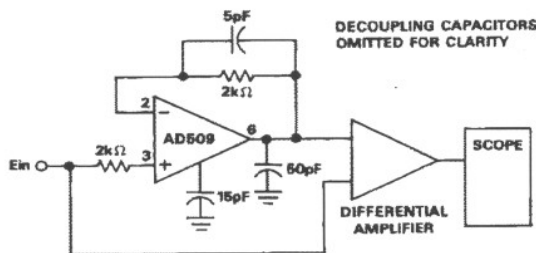

Figure 2. AD509 Settling Time Test Circuit

display. The resultant waveform of $(E_O - E_{IN})$ of a typical AD509 is shown in Figure 3. Note that the waveform crosses the 1mV point representing 0.01% accuracy in approximately 1.5µs. The top trace represents the output signal; the bottom trace represents the error signal.

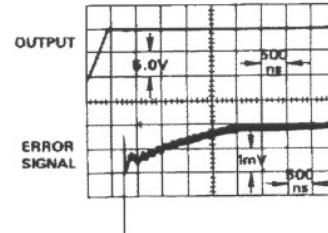

Figure 3. Settling Time of AD509

SETTLING TIME VS. R_f AND R_i . Settling time of an amplifier is a function of the feedback and input resistors, since they interact with the input capacitance of the amplifier. When operating in the non-inverting mode, the source impedance should be kept relatively low; e.g., 5kΩ; in order to insure optimum performance. The small feedback capacitor (5pF) is used in the settling time test circuit in parallel with the feedback resistor to reduce ringing. This capacitor partially cancels the pole formed in the loop gain response as a result of the feedback and input resistors, and the input capacitance.

SETTLING TIME VS. CAPACITIVE LOAD. The AD509 will drive capacitive loads of 500pF without appreciable deterioration in settling time. Larger capacitive loads can be driven by tailoring the compensation to minimize settling time. Figure 4 shows the settling time of a typical AD509 compensated for unity gain with a 15pF capacitor, with a 500pF capacitive load on the output. Note that settling time to 0.01% is still under 2.0µs.

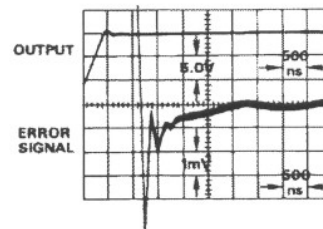

Figure 4. AD509 with 500pF Capacitive Load

SUGGESTIONS FOR MINIMIZING SETTLING TIME. The AD509 has been designed to settle to 0.01% accuracy in 1 to 2.5µs. However, this amplifier is only a building block in a circuit that also has a feedback network, input and output connections, power supply connections, and a number of external components. What has been painstakingly gained in amplifier design can be lost without careful circuit design. Some of the elements of a good high speed design are.....

CONNECTIONS. It is essential that care be taken in the signal and power ground connections to avoid inducing or generating extraneous voltages in the ground signal paths.

AD509

The 0.1µF ceramic power supply bypass capacitors are considerably more important for the AD509 than for low frequency general purpose amplifiers. Their main purpose is to convert the distributed high frequency ground to a lumped single point (the V+ point). The V+ to V- 0.1µF capacitor equalizes the supply grounds while the 0.1µF capacitor from V+ to signal ground should be returned to signal common. The signal common, which is bypassed to pin 7, is defined as that point at which the input signal source, the feedback network, and the return side of the load are joined to the power common.

Note that the diagram shows each individual capacitor directly connected to the appropriate terminal (pin 7 [V+]).

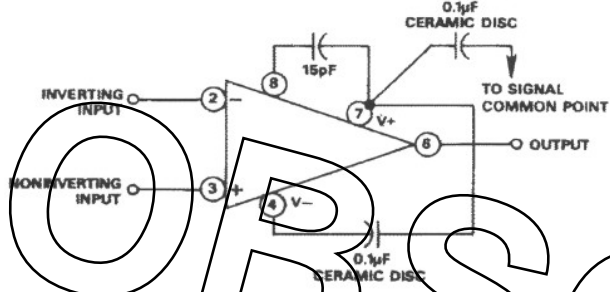

Figure 5. Configuration for Unity Gain Applications

In addition, it is suggested that all connections be short and direct, and as physically close to the case as possible, so that the length of any conducting path shared by external components will be minimized.

COMPONENTS. Resistors are preferably metal film types, because they have less capacitance and stray inductance than wirewound types, and are available with excellent accuracies and temperature coefficients.

Diodes are hot carrier types for the very fastest-settling applications, but 1N914 types are suitable for more routine uses.

Capacitors in critical locations are polystyrene, teflon, or polycarbonate to minimize dielectric absorption.

CIRCUIT. For the fastest settling times, keep leads short, orient components to minimize stray capacitance, keep circuit impedance levels as low as consistent with the output capabilities of the amplifier and the signal source, reduce all external load capacitances to the absolute minimum. Don't overlook sockets or printed circuit board mounting as possible sources of dielectric absorption. Avoid pole-zero mismatches in any feedback networks used with the amplifier. Minimize noise pickup.

DYNAMIC RESPONSE OF AD509

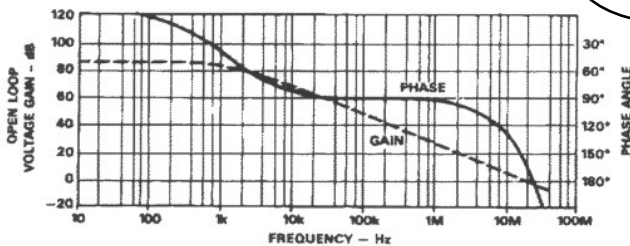

Figure 6. Open Loop Frequency and Phase Response

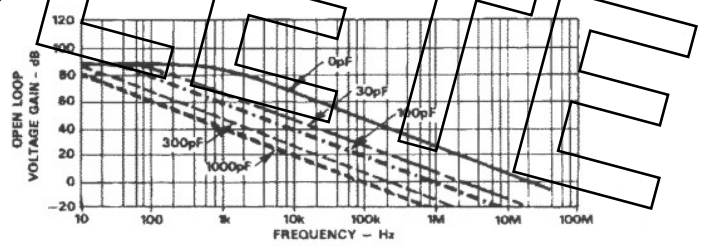

Figure 7. Open Loop Frequency Response for Various C_c's

THE AD509 AS AN OUTPUT AMPLIFIER FOR FAST CURRENT-OUTPUT D-TO-A CONVERTERS

Most fast integrated circuit digital to analog converters have current outputs. That is, the digital input code is translated to an output current proportional to the digital code. In many applications, that output current is converted to a voltage by connecting an operational amplifier in the current-to-voltage conversion mode.

The settling time of the combination depends on the settling time of the DAC and the output amplifier. A good approximation is:

$$t_s \text{ TOTAL} = \sqrt{(t_s \text{ DAC})^2 + (t_s \text{ AMP})^2}$$

Some IC DACs settle to final output value in 100-500 nanoseconds. Since most IC op amps require a longer time to settle to ±0.1% or ±0.01% of final value, amplifier settling time can dominate total settling time. And for a 12-bit DAC, one least significant bit is only 0.024% of full-scale, so low drift and high linearity and precision are also required of the output amplifier.

Figure 8 shows the AD509K connected as an output amplifier with the AD565K, high speed 12-bit IC digital-to-analog converter. The 10 picofarad capacitor, C1, compensates for the 25pF AD565 output capacitance. The voltage output of the AD565K/AD509K combination settles to ±0.01% in one microsecond. The low input voltage drift and high open loop gain of the AD509K assures 12-bit accuracy over the operating temperature range.

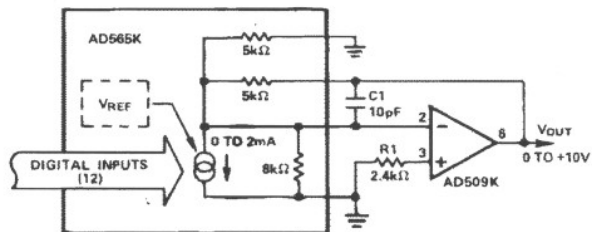

Figure 8. AD509 as an Output Amplifier for a Fast Current-Output D-to-A Converter