

FEATURES

ITU-R¹ BT601/BT656 YCrCb to PAL/NTSC video encoder

High quality 10-bit video DACs

SSAF™ (super sub-alias filter)

Advanced power management features

CGMS (copy generation management system)

WSS (wide screen signaling)

NTSC M, PAL N², PAL B/D/G/H/I, PAL-M³, PAL 60

Single 27 MHz clock required (×2 oversampling)

Macrovision 7.1 (ADV7174 only)

80 dB video SNR

32-bit direct digital synthesizer for color subcarrier

Multistandard video output support:

Composite (CVBS)

Component S-video (Y/C)

Video input data port supports:

CCIR-656 4:2:2 8-bit parallel input format

Programmable simultaneous composite and S-video or RGB (SCART)/YPbPr video outputs

Programmable luma filters low-pass [PAL/NTSC] notch, extended SSAF, CIF, and QCIF

Programmable chroma filters (low-pass [0.65 MHz, 1.0 MHz, 1.2 MHz, and 2.0 MHz], CIF, and QCIF)

Programmable VBI (vertical blanking interval)

Programmable subcarrier frequency and phase

Programmable LUMA delay

Individual on/off control of each DAC

CCIR and square pixel operation

Integrated subcarrier locking to external video source

Color signal control/burst signal control

Interlaced/noninterlaced operation

Complete on-chip video timing generator

Programmable multimode master/slave operation

Closed captioning support

Teletext insertion port (PAL-WST)

On-board color bar generation

On-board voltage reference

2-wire serial MPU interface (I²C® compatible and fast I²C)

Single-supply 2.8 V and 3.3 V operation

Small 40-lead 6 mm × 6 mm LFCSP package

−40°C to +85°C at 3.3 V

−20°C to +85°C at 2.8 V

APPLICATIONS

Portable video applications

Mobile phones

Digital still cameras

FUNCTIONAL BLOCK DIAGRAM

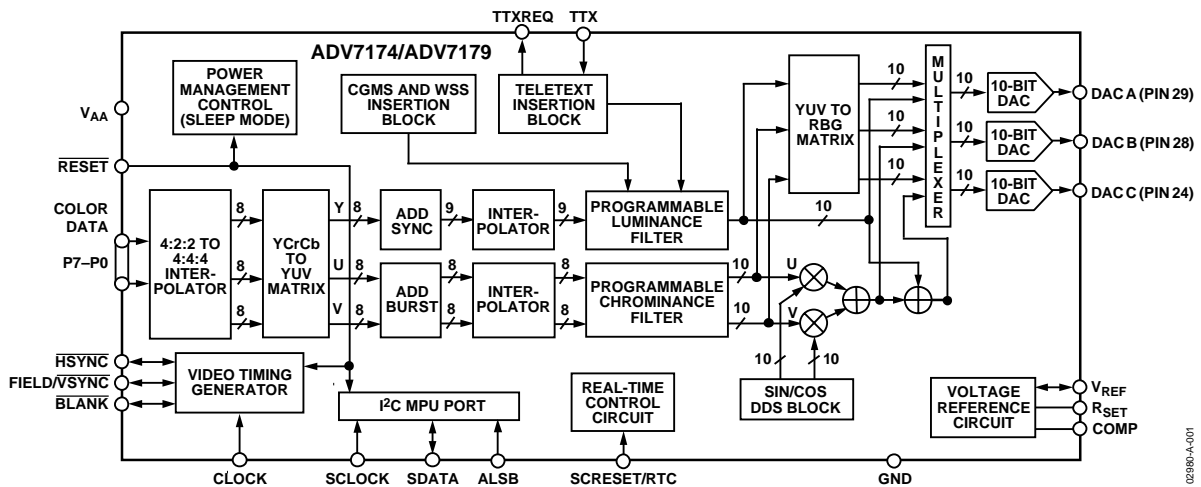

Figure 1.

¹ ITU-R and CCIR are used interchangeably in this document (ITU-R has replaced CCIR recommendations).

² Throughout the document, N is referenced to PAL – Combination – N.

³ ADV7174 only.

Protected by U.S. Patent Numbers 5,343,196 and 5,442,355 and other intellectual property rights.

Protected by U.S. Patent Numbers 4,631,603, 4,577,216, 4,819,098 and other intellectual property rights. The Macrovision anticopy process is licensed for noncommercial home use only, which is its sole intended use in the device. Contact the sales office for the latest Macrovision version available.

Rev. A

Information furnished by Analog Devices is believed to be accurate and reliable. However, no responsibility is assumed by Analog Devices for its use, nor for any infringements of patents or other rights of third parties that may result from its use. Specifications subject to change without notice. No license is granted by implication or otherwise under any patent or patent rights of Analog Devices. Trademarks and registered trademarks are the property of their respective owners.

One Technology Way, P.O. Box 9106, Norwood, MA 02062-9106, U.S.A.

Tel: 781.329.4700

Fax: 781.326.8703

www.analog.com

© 2004 Analog Devices, Inc. All rights reserved.

TABLE OF CONTENTS

Specifications.....	4	Mode 3: Master/Slave Option $\overline{\text{HSYNC}}$, $\overline{\text{BLANK}}$, $\overline{\text{FIELD}}$..	24
2.8 V Specifications	4	Power-On Reset	25
2.8 V Timing Specifications	5	SCH Phase Mode.....	25
3.3 V Specifications	6	MPU Port Description.....	25
3.3 V Timing Specifications	7	Register Accesses	26
Absolute Maximum Ratings.....	9	Register Programming.....	27
ESD Caution.....	9	Subaddress Register (SR7–SR0)	27
Pin Configuration and Function Descriptions.....	10	Register Select (SR5–SR0)	27
General Description	11	Mode Register 1 (MR1)	29
Data Path Description.....	11	Mode Register 2 (MR2)	30
Internal Filter Response.....	11	Mode Register 3 (MR3)	31
Typical Performance Characteristics	13	Mode Register 4 (MR4)	32
Features	16	Timing Mode Register 0 (TR0)	33
Color Bar Generation	16	Timing Mode Register 1 (TR1)	34
Square Pixel Mode.....	16	Subcarrier Frequency Registers 3–0	35
Color Signal Control.....	16	Subcarrier Phase Register.....	35
Burst Signal Control.....	16	Closed Captioning Even Field Data Registers 1–0	35
NTSC Pedestal Control	16	Closed Captioning Odd Field Data Registers 1–0	36
Pixel Timing Description	16	NTSC Pedestal/PAL Teletext Control Registers 3–0	36
8-Bit YCrCb Mode	16	Teletext Request Control Register (TC07)	37
Subcarrier Reset.....	16	CGMS_WSS Register 0 (C/W0).....	37
Real-Time Control	16	CGMS_WSS Register 1 (C/W1).....	38
Video Timing Description	16	CGMS_WSS Register 2 (C/W2).....	38
Vertical Blanking Data Insertion.....	17	Appendix 1—Board Design and Layout Considerations.....	39
Mode 0 (CCIR-656): Slave Option.....	17	Ground Planes	39
Mode 0 (CCIR-656): Master Option	17	Power Planes	39
Mode 1: Slave Option $\overline{\text{HSYNC}}$, $\overline{\text{BLANK}}$, $\overline{\text{FIELD}}$	20	Supply Decoupling	40
Mode 1: Master Option $\overline{\text{HSYNC}}$, $\overline{\text{BLANK}}$, $\overline{\text{FIELD}}$	21	Digital Signal Interconnect	40
Mode 2: Slave Option $\overline{\text{HSYNC}}$, $\overline{\text{VSYNC}}$, $\overline{\text{BLANK}}$	22	Analog Signal Interconnect.....	40
Mode 2: Master Option $\overline{\text{HSYNC}}$, $\overline{\text{VSYNC}}$, $\overline{\text{BLANK}}$	23	Appendix 2—Closed Captioning	41

Appendix 3—Copy Generation Management System (CGMS)	42	NTSC Waveforms (without Pedestal)	46
Function of CGMS Bits	42	PAL Waveforms	47
Appendix 4—Wide Screen Signaling (WSS)	43	Pb Pr Waveforms.....	48
Function of WSS Bits	43	Appendix 7—Optional Output Filter	49
Appendix 5—Teletext	44	Appendix 8—Recommended Register Values.....	50
Teletext Insertion.....	44	Outline Dimensions.....	52
Teletext Protocol.....	44	Ordering Guide	52
Appendix 6—Waveforms	45		
NTSC Waveforms (with Pedestal)	45		

REVISION HISTORY

2/04—Changed from REV. 0 to REV A.

Added 2.8 V Version	Universal
Format Updated.....	Universal
Device Currents Updated on 3.3 V Specification	Universal
Added new Table 1 and Renumbered Subsequent Tables.....	4
Added new Table 2 and Renumbered Subsequent Tables	5
Change to Figure 54	38
Change to Figure 55	39
Change to Figure 79	48
Changed Ordering Guide Temperature Specifications	52
Updated Outline Dimensions.....	52

10/02—Revision 0: Initial Version

SPECIFICATIONS

2.8 V SPECIFICATIONS

$V_{AA} = 2.8\text{ V}$, $V_{REF} = 1.235\text{ V}$, $R_{SET} = 150\ \Omega$. All specifications T_{MIN} to T_{MAX} ¹, unless otherwise noted.

Table 1.

Parameter	Conditions ¹	Min	Typ	Max	Unit
STATIC PERFORMANCE ²					
Resolution (Each DAC)				10	Bits
Accuracy (Each DAC)					
Integral Nonlinearity	$R_{SET} = 300\ \Omega$		± 3.0		LSB
Differential Nonlinearity	Guaranteed monotonic			± 1	LSB
DIGITAL INPUTS ²					
Input High Voltage, V_{INH}		1.6			V
Input Low Voltage, V_{INL}				0.7	V
Input Current, I_{IN}	$V_{IN} = 0.4\text{ V or }2.4\text{ V}$			± 1	μA
Input Capacitance, C_{IN}			10		pF
DIGITAL OUTPUTS ²					
Output High Voltage, V_{OH}	$I_{SOURCE} = 400\ \mu\text{A}$	2.4			V
Output Low Voltage, V_{OL}	$I_{SINK} = 3.2\text{ mA}$			0.4	V
Three-State Leakage Current				10	μA
Three-State Output Capacitance			10		pF
ANALOG OUTPUTS ²					
Output Current ³	$R_{SET} = 150\ \Omega$, $R_L = 37.5\ \Omega$	33	34.7	37	mA
DAC-to-DAC Matching			2.0		%
Output Compliance, V_{OC}		0		1.4	V
Output Impedance, R_{OUT}			30		k Ω
Output Capacitance, C_{OUT}	$I_{OUT} = 0\text{ mA}$			30	pF
POWER REQUIREMENTS ^{2,4}					
V_{AA}		2.8			V
Normal Power Mode					
I_{DAC} (Max) ⁵	$R_{SET} = 150\ \Omega$, $R_L = 37.5\ \Omega$		115	120	mA
I_{CCT} ⁶			30		mA
Low Power Mode					
I_{DAC} (Max) ⁵			62		mA
I_{CCT} ⁶			30		mA
Sleep Mode					
I_{DAC} ⁷			0.1		μA
I_{CCT} ⁸			0.001		μA
Power Supply Rejection Ratio	COMP = 0.1 μF		0.01	0.5	%/%

¹ Temperature range T_{MIN} to T_{MAX} : -20°C to $+85^\circ\text{C}$.

² Guaranteed by characterization.

³ DACs can output 35 mA typically at 2.8 V ($R_{SET} = 150\ \Omega$ and $R_L = 37.5\ \Omega$). Full drive into 37.5 Ω load.

⁴ Power measurements are taken with clock frequency = 27 MHz. Max $T_J = 110^\circ\text{C}$.

⁵ I_{DAC} is the total current (min corresponds to 5 mA output per DAC, max corresponds to 37 mA output per DAC) to drive all three DACs. Turning off individual DACs reduces I_{DAC} correspondingly.

⁶ I_{CCT} (circuit current) is the continuous current required to drive the device.

⁷ Total DAC current in sleep mode.

⁸ Total continuous current during sleep mode.

2.8 V TIMING SPECIFICATIONS

$V_{AA} = 2.8\text{ V}$, $V_{REF} = 1.235\text{ V}$, $R_{SET} = 150\ \Omega$. All specifications T_{MIN} to T_{MAX}^1 , unless otherwise noted.

Table 2.

Parameter	Conditions ¹	Min	Typ	Max	Unit
MPU PORT ^{2, 3}					
SCLOCK Frequency		0		400	kHz
SCLOCK High Pulse Width, t_1		0.6			μs
SCLOCK Low Pulse Width, t_2		1.3			μs
Hold Time (Start Condition), t_3	After this period the first clock is generated	0.6			μs
Setup Time (Start Condition), t_4	Relevant for repeated start condition	0.6			μs
Data Setup Time, t_5		100			ns
SDATA, SCLOCK Rise Time, t_6				300	ns
SDATA, SCLOCK Fall Time, t_7				300	ns
Setup Time (Stop Condition), t_8		0.6			μs
ANALOG OUTPUTS ^{3, 4}					
Analog Output Delay			7		ns
DAC Analog Output Skew			0		ns
CLOCK CONTROL AND PIXEL PORT ^{4, 5}					
f_{CLOCK}			27		MHz
Clock High Time, t_9		8			ns
Clock Low Time, t_{10}		8			ns
Data Setup Time, t_{11}		3.5			ns
Data Hold Time, t_{12}		4			ns
Control Setup Time, t_{11}		4			ns
Control Hold Time, t_{12}		3			ns
Digital Output Access Time, t_{13}			12		ns
Digital Output Hold Time, t_{14}			8		ns
Pipeline Delay, t_{PD}^5			48		Clock Cycles
TELETEXT ^{3, 4, 6}					
Digital Output Access Time, t_{16}			23		ns
Data Setup Time, t_{17}			2		ns
Data Hold Time, t_{18}			6		ns
RESET CONTROL ^{3, 4}					
RESET Low Time		6			ns

¹ Temperature range T_{MIN} to T_{MAX} : -20°C to $+85^\circ\text{C}$.

² TTL input values are 0 V to 2.8 V, with input rise/fall times -3 ns , measured between the 10% and 90% points. Timing reference points at 50% for inputs and outputs.

Analogue output load -10 pF .

³ Guaranteed by characterization.

⁴ Output delay measured from the 50% point of the rising edge of CLOCK to the 50% point of full-scale transition.

⁵ See Figure 60.

⁶ Teletext Port consists of the following:

Teletext Output: TTXREQ

Teletext Input: TTX

ADV7174/ADV7179

3.3 V SPECIFICATIONS

$V_{AA} = 3.0\text{ V} - 3.6\text{ V}^1$, $V_{REF} = 1.235\text{ V}$, $R_{SET} = 150\ \Omega$. All specifications T_{MIN} to T_{MAX}^2 , unless otherwise noted.

Table 3.

Parameter	Conditions ¹	Min	Typ	Max	Unit
STATIC PERFORMANCE³					
Resolution (Each DAC)				10	Bits
Accuracy (Each DAC)			± 0.6		LSB
Integral Nonlinearity	$R_{SET} = 300\ \Omega$			± 1	LSB
Differential Nonlinearity	Guaranteed Monotonic				LSB
DIGITAL INPUTS³					
Input High Voltage, V_{INH}		2			V
Input Low Voltage, V_{INL}				0.8	V
Input Current, $I_{IN}^{3,4}$	$V_{IN} = 0.4\text{ V or } 2.4\text{ V}$			± 1	μA
Input Capacitance, C_{IN}			10		pF
DIGITAL OUTPUTS³					
Output High Voltage, V_{OH}	$I_{SOURCE} = 400\ \mu\text{A}$	2.4			V
Output Low Voltage, V_{OL}	$I_{SINK} = 3.2\text{ mA}$			0.4	V
Three-State Leakage Current				10	μA
Three-State Output Capacitance			10		pF
ANALOG OUTPUTS³					
Output Current ^{4,5}	$R_{SET} = 150\ \Omega$, $R_L = 37.5\ \Omega$	33	34.7	37	mA
Output Current ⁶	$R_{SET} = 1041\ \Omega$, $R_L = 262.5\ \Omega$		5		mA
DAC-to-DAC Matching			2.0		%
Output Compliance, V_{OC}		0		1.4	V
Output Impedance, R_{OUT}			30		k Ω
Output Capacitance, C_{OUT}	$I_{OUT} = 0\text{ mA}$			30	pF
POWER REQUIREMENTS^{3,7}					
V_{AA}		3.0	3.3	3.6	V
Normal Power Mode					
$I_{DAC}(\text{Max})^8$	$R_{SET} = 150\ \Omega$, $R_L = 37.5\ \Omega$		115	120	mA
$I_{DAC}(\text{Min})^8$	$R_{SET} = 1041\ \Omega$, $R_L = 262.5\ \Omega$		20		mA
I_{CCT}^9			35		mA
Low Power Mode					
$I_{DAC}(\text{Max})^8$			62		mA
$I_{DAC}(\text{Min})^8$			20		mA
I_{CCT}^9			35		mA
Sleep Mode					
I_{DAC}^{10}			0.1		μA
I_{CCT}^{11}			0.001		μA
Power Supply Rejection Ratio	COMP = 0.1 μF		0.01	0.5	%/%

¹ The max/min specifications are guaranteed over this range. The max/min values are typical over 3.0 V to 3.6 V.

² Temperature range T_{MIN} to T_{MAX} : -40°C to $+85^\circ\text{C}$.

³ Guaranteed by characterization.

⁴ Full drive into 37.5 Ω load.

⁵ DACs can output 35 mA typically at 3.3 V ($R_{SET} = 150\ \Omega$ and $R_L = 37.5\ \Omega$), optimum performance obtained at 18 mA DAC current ($R_{SET} = 300\ \Omega$ and $R_L = 75\ \Omega$).

⁶ Minimum drive current (used with buffered/scaled output load).

⁷ Power measurements are taken with clock frequency = 27 MHz. Max $T_J = 110^\circ\text{C}$.

⁸ I_{DAC} is the total current (min corresponds to 5 mA output per DAC, max corresponds to 37 mA output per DAC) to drive all three DACs. Turning off individual DACs reduces I_{DAC} correspondingly.

⁹ I_{CCT} (circuit current) is the continuous current required to drive the device.

¹⁰ Total DAC current in sleep mode.

¹¹ Total continuous current during sleep mode.

3.3 V TIMING SPECIFICATIONS

$V_{AA} = 3.0\text{ V} - 3.6\text{ V}^1$, $V_{REF} = 1.235\text{ V}$, $R_{SET} = 150\ \Omega$. All specifications T_{MIN} to T_{MAX}^2 , unless otherwise noted.

Table 4.

Parameter	Conditions ¹	Min	Typ	Max	Unit
MPU PORT ^{3,4}					
SCLOCK Frequency		0		400	kHz
SCLOCK High Pulse Width, t_1		0.6			μs
SCLOCK Low Pulse Width, t_2		1.3			μs
Hold Time (Start Condition), t_3	After this period, the first clock is generated	0.6			μs
Setup Time (Start Condition), t_4	Relevant for repeated start condition	0.6			μs
Data Setup Time, t_5		100			ns
SDATA, SCLOCK Rise Time, t_6				300	ns
SDATA, SCLOCK Fall Time, t_7				300	ns
Setup Time (Stop Condition), t_8		0.6			μs
ANALOG OUTPUTS ^{3,5}					
Analog Output Delay			7		ns
DAC Analog Output Skew			0		ns
CLOCK CONTROL AND PIXEL PORT ^{4,5}					
f_{CLOCK}			27		MHz
Clock High Time, t_9		8			ns
Clock Low Time, t_{10}		8			ns
Data Setup Time, t_{11}		3.5			ns
Data Hold Time, t_{12}		4			ns
Control Setup Time, t_{11}		4			ns
Control Hold Time, t_{12}		3			ns
Digital Output Access Time, t_{13}			12		ns
Digital Output Hold Time, t_{14}			8		ns
Pipeline Delay, t_{PD}^6			48		Clock Cycles
TELETEXT ^{3,4}					
Digital Output Access Time, t_{16}			23		ns
Data Setup Time, t_{17}			2		ns
Data Hold Time, t_{18}			6		ns
RESET CONTROL ^{3,4}					
RESET Low Time		6			ns

¹ The maximum/minimum specifications are guaranteed over this range. The maximum/minimum values are typical over 3.0 V to 3.6 V range.

² Temperature range T_{MIN} to T_{MAX} : -40°C to $+85^\circ\text{C}$.

³ TTL input values are 0 V to 3 V, with input rise/fall times ~ 3 ns, measured between the 10% and 90% points. Timing reference points at 50% for inputs and outputs. Analog output load ~ 10 pF.

⁴ Guaranteed by characterization.

⁵ Output delay measured from the 50% point of the rising edge of CLOCK to the 50% point of full-scale transition.

⁶ See Figure 60.

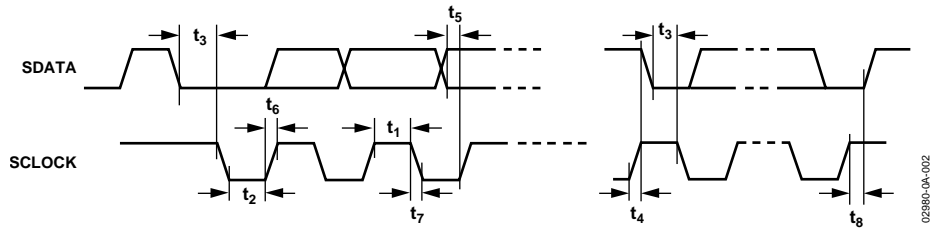

Figure 2. MPU Port Timing Diagram

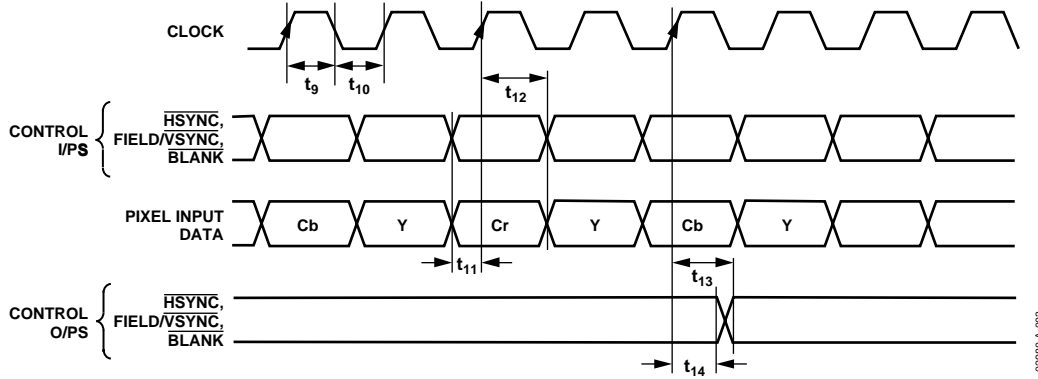

Figure 3. Pixel and Control Data Timing Diagram

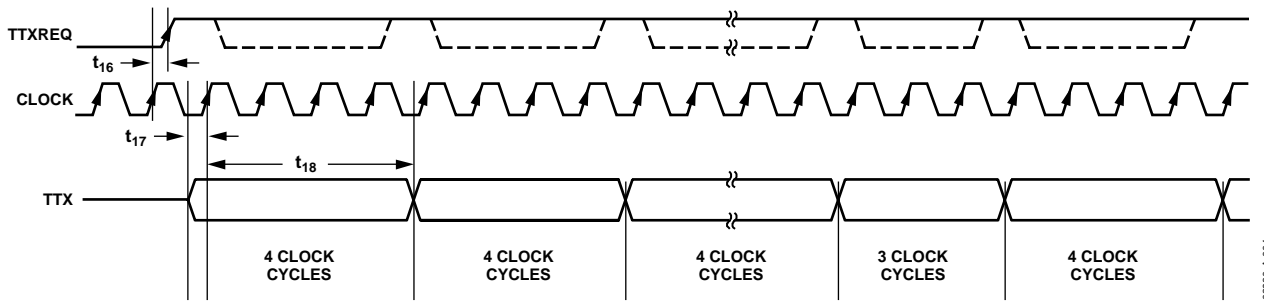

Figure 4. Teletext Timing Diagram

ABSOLUTE MAXIMUM RATINGS

Table 5.

Parameter	Rating
V_{AA} to GND	4 V
Voltage on Any Digital Input Pin	GND – 0.5 V to $V_{AA} + 0.5$ V
Storage Temperature (T_s)	–65°C to +150°C
Junction Temperature (T_j)	150°C
Lead Temperature Soldering, 10 sec	260°C
Analog Outputs to GND ¹	GND – 0.5 V to V_{AA}
θ_{JA} ²	30°C/W

Stresses above those listed under Absolute Maximum Ratings may cause permanent damage to the device. This is a stress rating only; functional operation of the device at these or any other conditions above those listed in the operational sections of this specification is not implied. Exposure to absolute maximum rating conditions for extended periods may affect device reliability.

¹ Analog output short circuit to any power supply or common can be of an indefinite duration.

² With the exposed metal paddle on the underside of LFCSO soldered to GND on the PCB.

ESD CAUTION

ESD (electrostatic discharge) sensitive device. Electrostatic charges as high as 4000 V readily accumulate on the human body and test equipment and can discharge without detection. Although this product features proprietary ESD protection circuitry, permanent damage may occur on devices subjected to high energy electrostatic discharges. Therefore, proper ESD precautions are recommended to avoid performance degradation or loss of functionality.



PIN CONFIGURATION AND FUNCTION DESCRIPTIONS

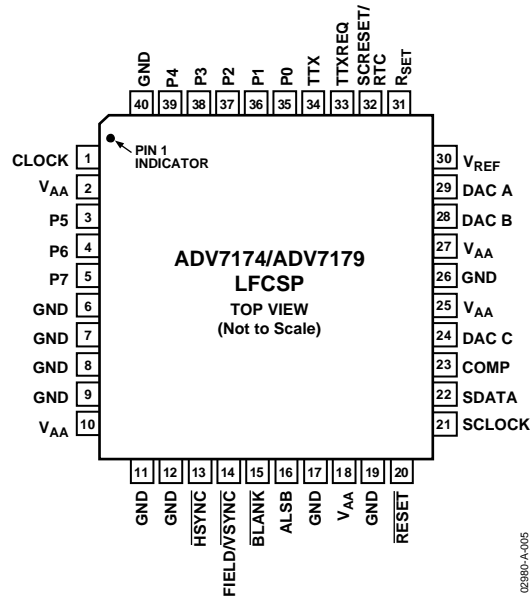

Figure 5. Pin Configurations

Table 6. Pin Function Descriptions

Mnemonic	Input/Output	Function
P7–P0	I	8-Bit 4:2:2 Multiplexed YCrCb Pixel Port (P7–P0). P0 is the LSB.
CLOCK	I	TTL Clock Input. Requires a stable 27 MHz reference clock for standard operation. Alternatively, a 24.5454 MHz (NTSC) or 29.5 MHz (PAL) can be used for square pixel operation.
HSYNC	I/O	HSYNC (Modes 1 and 2) Control Signal. This pin may be configured to output (master mode) or accept (slave mode) sync signals.
FIELD/VSYNC	I/O	Dual Function FIELD (Mode 1) and VSYNC (Mode 2) Control Signal. This pin may be configured to output (master mode) or accept (slave mode) these control signals.
BLANK	I/O	Video Blanking Control Signal. The pixel inputs are ignored when this is Logic 0. This signal is optional.
SCRESET/RTC	I	This pin can be configured as an input by setting MR22 and MR21 of Mode Register 2. It can be configured as a subcarrier reset pin, in which case a low-to-high transition on this pin resets the subcarrier to Field 0. Alternatively, it can be configured as a real-time control (RTC) input.
VREF	I/O	Voltage Reference Input for DACs or Voltage Reference Output (1.235 V).
RSET	I	A 150 Ω resistor connected from this pin to GND is used to control full-scale amplitudes of the video signals.
COMP	O	Compensation Pin. Connect a 0.1 μF capacitor from COMP to VAA. For optimum dynamic performance in low power mode, the value of the COMP capacitor can be lowered to as low as 2.2 nF.
DAC A	O	DAC Output (see Table 13)
DAC B	O	DAC Output (see Table 13).
DAC C	O	DAC Output (see Table 13).
SCLOCK	I	MPU Port Serial Interface Clock Input.
SDATA	I/O	MPU Port Serial Data Input/Output.
ALSB	I	TTL Address Input. This signal sets up the LSB of the MPU address.
RESET	I	This input resets the on-chip timing generator and sets the ADV7174/ADV7179 into default mode. This is NTSC operation, Timing Slave Mode 0, 8-bit operation, 2× composite out signals. DACs A, B, and C are enabled.
TTX	I	Teletext Data.
TTXREQ	O	Teletext Data Request Signal/Defaults to GND when Teletext Not Selected.
VAA	P	Power Supply (2.8 V or 3.3 V).
GND	G	Ground Pin.

GENERAL DESCRIPTION

The ADV7174/ADV7179 is an integrated digital video encoder that converts digital CCIR-601 4:2:2 8-bit component video data into a standard analog baseband television signal compatible with worldwide standards.

The on-board SSAF (super sub-alias filter) with extended luminance frequency response and sharp stop-band attenuation enables studio quality video playback on modern TVs, giving optimal horizontal line resolution.

An advanced power management circuit enables optimal control of power consumption in both normal operating modes and in power-down or sleep modes.

The ADV7174/ADV7179 supports both PAL and NTSC square pixel operation. The parts incorporate WSS and CGMS-A data control generation.

The output video frames are synchronized with the incoming data timing reference codes. Optionally, the encoder accepts (and can generate) HSYNC, VSYNC, and FIELD timing signals. These timing signals can be adjusted to change pulse width and position while the part is in the master mode. The encoder requires a signal two times the pixel rate (27 MHz) clock for standard operation. Alternatively, the encoder requires a 24.5454 MHz clock for NTSC or 29.5 MHz clock for PAL square pixel mode operation. All internal timing is generated on-chip.

A separate Teletext port enables the user to directly input Teletext data during the vertical blanking interval.

The ADV7174/ADV7179 modes are set up over a 2-wire serial bidirectional port (I²C compatible) with two slave addresses.

The ADV7174/ADV7179 is packaged in a 40-lead 6 mm × 6 mm LFCSP package.

DATA PATH DESCRIPTION

For PAL B/D/G/H/I/M/N and NTSC M and N modes, YCrCb 4:2:2 data is input via the CCIR-656 compatible pixel port at a 27 MHz data rate. The pixel data is demultiplexed to form three data paths. Y typically has a range of 16 to 235, and Cr and Cb

typically have a range of 128 ± 112 ; however, it is possible to input data from 1 to 254 on both Y, Cb, and Cr. The ADV7174/ADV7179 supports PAL (B/D/G/H/I/M/N) and NTSC (with and without pedestal) standards. The appropriate SYNC, BLANK, and burst levels are added to the YCrCb data. Macrovision Anti-taping (ADV7174 only), closed-captioning, and Teletext levels are also added to Y and the resultant data is interpolated to a rate of 27 MHz. The interpolated data is filtered and scaled by three digital FIR filters.

The U and V signals are modulated by the appropriate subcarrier sine/cosine phases and added together to make up the chrominance signal. The luma (Y) signal can be delayed 1–3 luma cycles (each cycle is 74 ns) with respect to the chroma signal. The luma and chroma signals are then added together to make up the composite video signal. All edges are slew rate limited.

The YCrCb data is also used to generate RGB data with appropriate SYNC and BLANK levels. The RGB data is in synchronization with the composite video output. Alternatively, analog YPbPr data can be generated instead of RGB data.

The three 10-bit DACs can be used to output:

- Composite Video + Composite Video
- S-Video + Composite Video
- YPrPb Video
- SCART RGB Video

Alternatively, each DAC can be individually powered off if not required.

Video output levels are illustrated in Appendix 6.

INTERNAL FILTER RESPONSE

The Y filter supports several different frequency responses, including two low-pass responses, two notch responses, an extended (SSAF) response, a CIF response, and a QCIF response. The UV filter supports several different frequency responses, including four low-pass responses, a CIF response, and a QCIF response. These can be seen in Table 7 and Table 8 and Figure 6 to Figure 18.

ADV7174/ADV7179

Table 7. Luminance Internal Filter Specifications

Filter Type	Filter Selection			Pass-Band Ripple (dB)	3 dB Bandwidth (MHz)	Stop-Band Cutoff (MHz)	Stop-Band Attenuation (dB)
	MR04	MR03	MR02				
Low-Pass (NTSC)	0	0	0	0.091	4.157	7.37	-56
Low-Pass (PAL)	0	0	1	0.15	4.74	7.96	-64
Notch (NTSC)	0	1	0	0.015	6.54	8.3	-68
Notch (PATL)	0	1	1	0.095	6.24	8.0	-66
Extended (SSAF)	1	0	0	0.051	6.217	8.0	-61
CIF	1	0	1	0.018	3.0	7.06	-61
QCIF	1	1	0	Monotonic	1.5	7.15	-50

Table 8. Chrominance Internal Filter Specifications

Filter Type	Filter Selection			Pass-Band Ripple (dB)	3 dB Bandwidth (MHz)	Stop-Band Cutoff (MHz)	Stop-Band Attenuation (dB)
	MR07	MR06	MR05				
1.3 MHz Low-Pass	0	0	0	0.084	1.395	3.01	-45
0.65 MHz Low-Pass	0	0	1	Monotonic	0.65	3.64	-58.5
1.0 MHz Low-Pass	0	1	0	Monotonic	1.0	3.73	-49
2.0 MHz Low-Pass	0	1	1	0.0645	2.2	5.0	-40
Reserved	1	0	0				
CIF	1	0	1	0.084	0.7	3.01	-45
QCIF	1	1	0	Monotonic	0.5	4.08	-50

TYPICAL PERFORMANCE CHARACTERISTICS

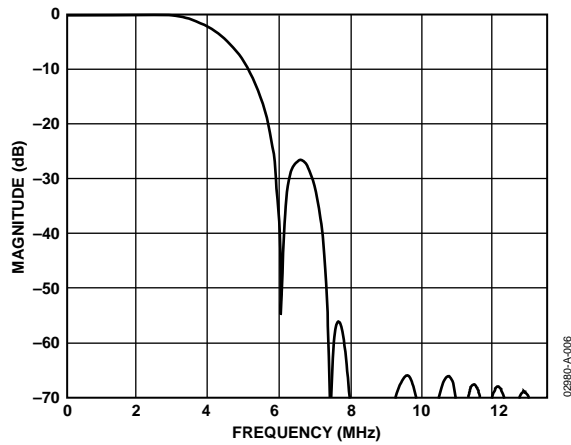

Figure 6. Chrominance Internal Filter Specifications

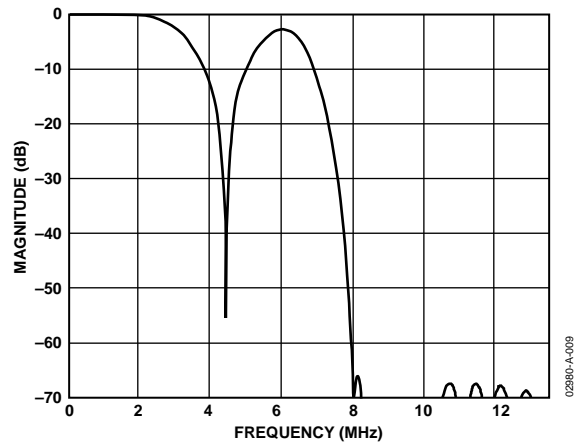

Figure 9. PAL Notch Luma Filter

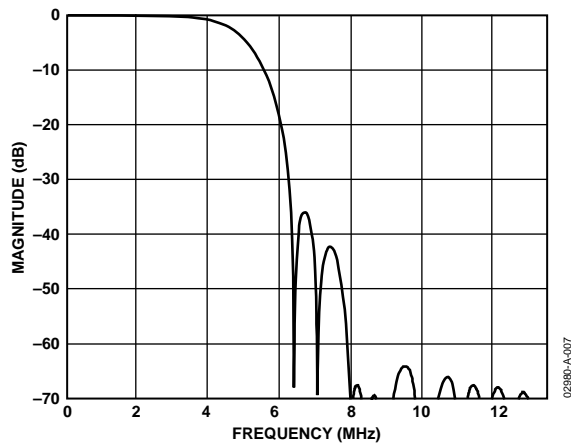

Figure 7. PAL Low-Pass Luma Filter

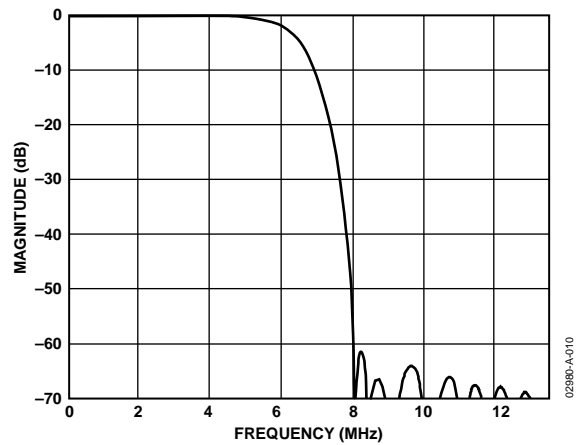

Figure 10. Extended Mode (SSAF) Luma Filter

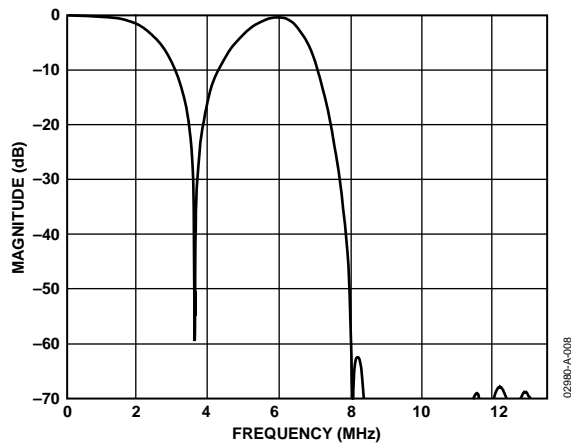

Figure 8. NTSC Notch Luma Filter

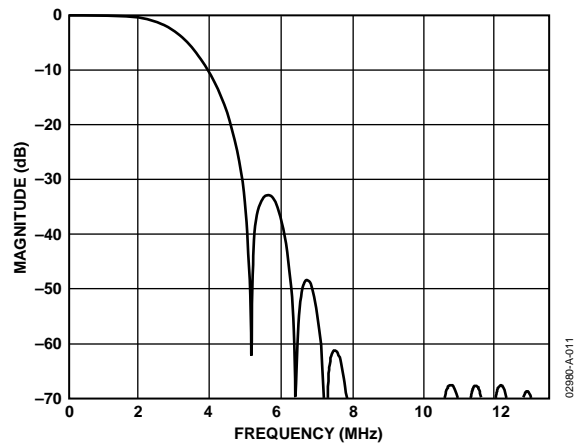

Figure 11. CIF Luma Filter

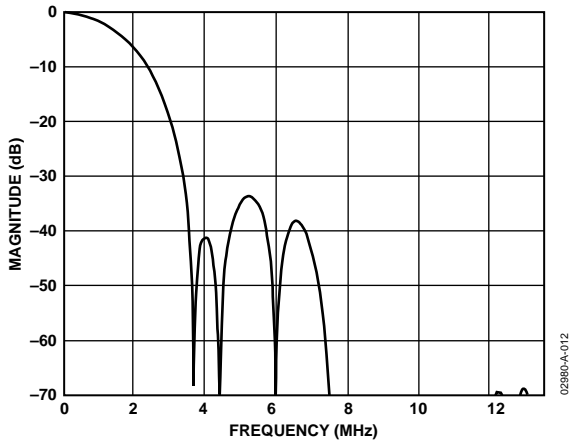

Figure 12. QCIF Luma Filter

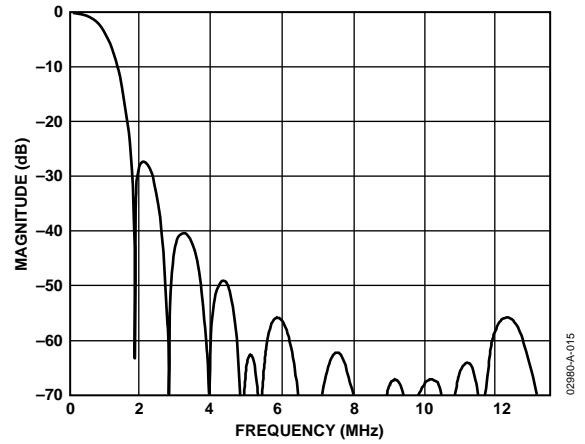

Figure 15. 1.0 MHz Low-Pass Chroma Filter

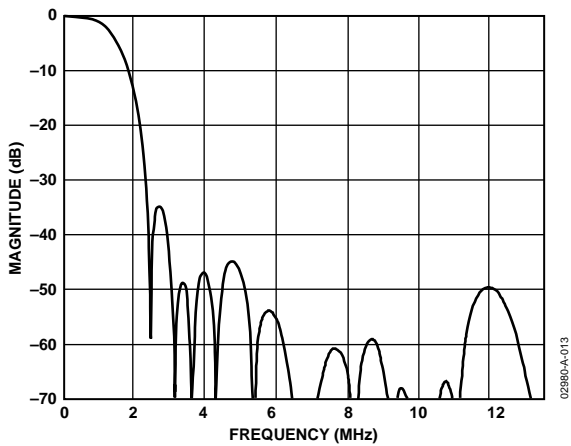

Figure 13. 1.3 MHz Low-Pass Chroma Filter

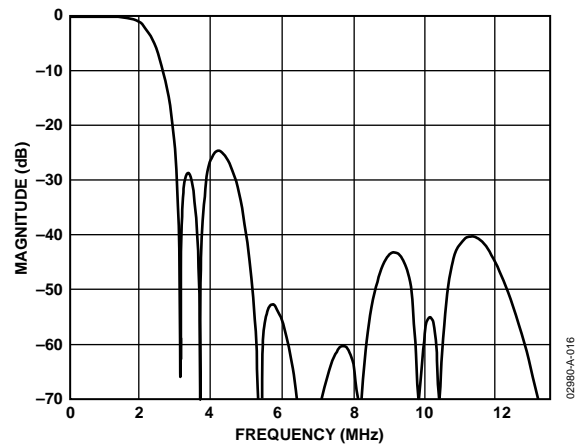

Figure 16. 2.0 MHz Low-Pass Chroma Filter

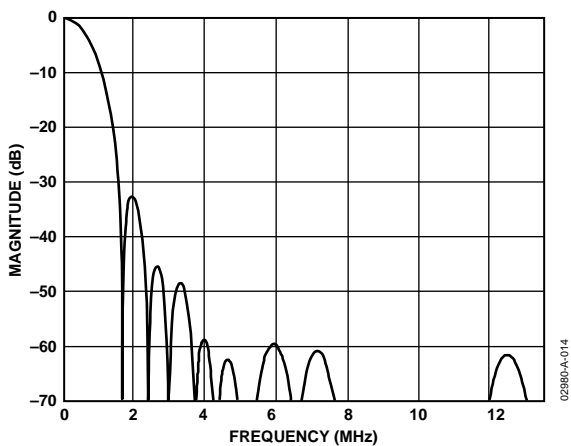

Figure 14. 0.65 MHz Low-Pass Chroma Filter

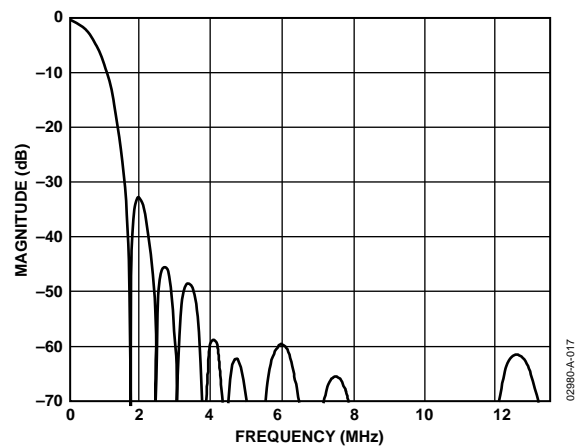

Figure 17. CIF Chroma Filter

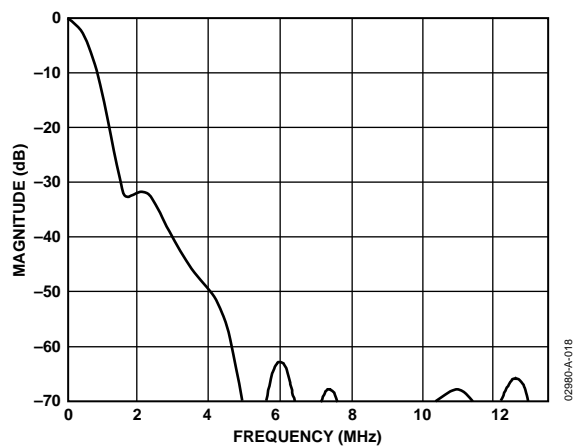

Figure 18. QCIF Chroma Filter

FEATURES

COLOR BAR GENERATION

The ADV7174/ADV7179 can be configured to generate 100/7.5/75/7.5 color bars for NTSC or 100/0/75/0 for PAL color bars. These are enabled by setting MR17 of Mode Register 1 to Logic 1.

SQUARE PIXEL MODE

The ADV7174/ADV7179 can be used to operate in square pixel mode. For NTSC operation, an input clock of 24.5454 MHz is required. Alternatively, for PAL operation, an input clock of 29.5 MHz is required. The internal timing logic adjusts accordingly for square pixel mode operation.

COLOR SIGNAL CONTROL

The color information can be switched on and off the video output using Bit MR24 of Mode Register 2.

BURST SIGNAL CONTROL

The burst information can be switched on and off the video output using Bit MR25 of Mode Register 2.

NTSC PEDESTAL CONTROL

The pedestal on both odd and even fields can be controlled on a line-by-line basis using the NTSC pedestal control registers. This allows the pedestals to be controlled during the vertical blanking interval.

PIXEL TIMING DESCRIPTION

The ADV7174/ADV7179 operates in an 8-bit YCrCb mode.

8-Bit YCrCb Mode

This default mode accepts multiplexed YCrCb inputs through the P7–P0 pixel inputs. The inputs follow the sequence Cb0, Y0 Cr0, Y1, Cb1, Y2, and so on. The Y, Cb, and Cr data are input on a rising clock edge.

SUBCARRIER RESET

Together with the SCRESET/RTC pin and Bits MR22 and MR21 of Mode Register 2, the ADV7174/ADV7179 can be used in subcarrier reset mode. The subcarrier resets to Field 0 at the start of the following field when a low-to-high transition occurs on this input pin.

REAL-TIME CONTROL

Together with the SCRESET/RTC pin and Bits MR22 and MR21 of Mode Register 2, the ADV7174/ADV7179 can be used to lock to an external video source. The real-time control mode allows the ADV7174/ADV7179 to automatically alter the subcarrier frequency to compensate for line length variation. When the part is connected to a device that outputs a digital data stream in the RTC format (such as a ADV7183A video decoder; see Figure 19), the part automatically changes to the compensated subcarrier frequency on a line-by-line basis. This digital data stream is 67 bits wide and the subcarrier is contained in Bits 0 to 21. Each bit is two clock cycles long. 00H should be written into all four subcarrier frequency registers when using this mode.

Video Timing Description

The ADV7174/ADV7179 is intended to interface with off-the-shelf MPEG1 and MPEG2 decoders. Consequently, the ADV7174/ADV7179 accepts 4:2:2 YCrCb pixel data via a CCIR-656 pixel port and has several video timing modes of operation that allow it to be configured as either a system master video timing generator or as a slave to the system video timing generator. The ADV7174/ADV7179 generates all of the required horizontal and vertical timing periods and levels for the analog video outputs.

The ADV7174/ADV7179 calculates the width and placement of analog sync pulses, blanking levels, and color burst envelopes. Color bursts are disabled on appropriate lines, and serration and equalization pulses are inserted where required.

In addition, the ADV7174/ADV7179 supports a PAL or NTSC square pixel operation in slave mode. The part requires an input pixel clock of 24.5454 MHz for NTSC and an input pixel clock of 29.5 MHz for PAL. The internal horizontal line counters place the various video waveform sections into the correct location for the new clock frequencies.

The ADV7174/ADV7179 has four distinct master and four distinct slave timing configurations. Timing control is established with the bidirectional HSYNC, BLANK, and FIELD/ $\overline{\text{VSYNC}}$ pins. Timing Mode Register 1 can also be used to vary the timing pulse widths and where they occur in relation to each other.

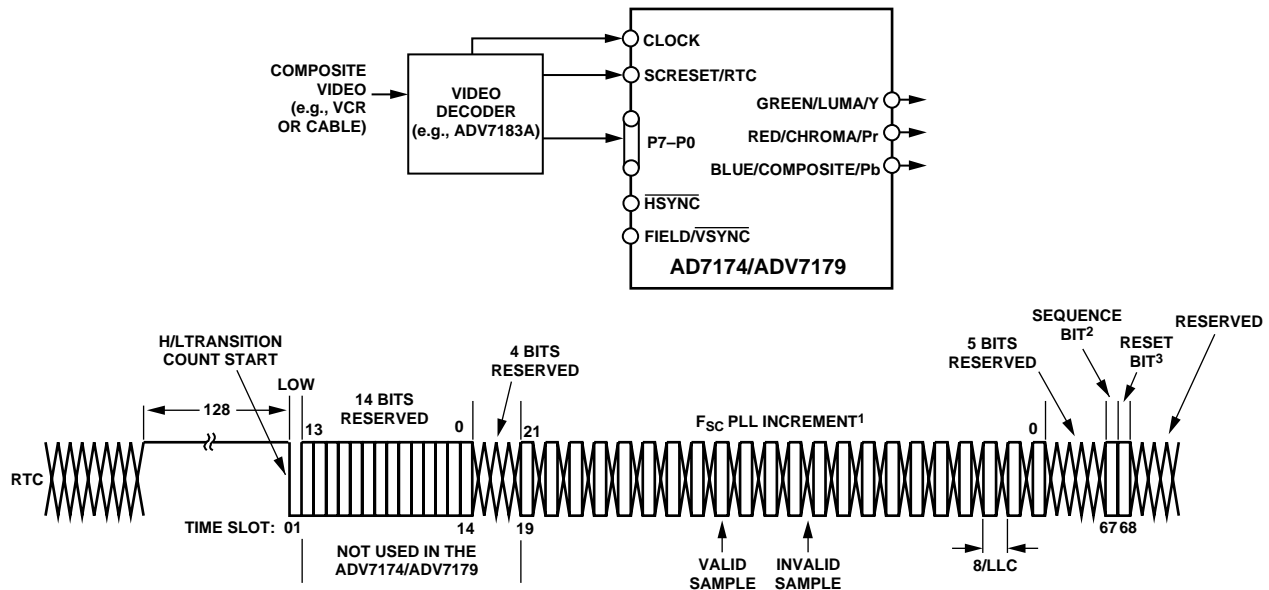

NOTES

- ¹F_{SC} PLL INCREMENT IS 22 BITS LONG, VALUE LOADED INTO ADV7174/ADV7179 F_{SC} DDS REGISTER IS F_{SC} PLL INCREMENT BITS 21:0 PLUS BITS 0:9 OF THE SUBCARRIER FREQUENCY REGISTERS. ALL ZEROS SHOULD BE WRITTEN TO THE SUBCARRIER FREQUENCY REGISTERS OF THE ADV7174/ADV7179.
- ²SEQUENCE BIT
PAL: 0 = LINE NORMAL, 1 = LINE INVERTED
NTSC: 0 = NO CHANGE
- ³RESET BIT
RESET ADV7174/ADV7179 DDS

Figure 19. RTC Timing and Connections

02890-A-019

Vertical Blanking Data Insertion

It is possible to allow encoding of incoming YCbCr data on those lines of VBI that do not bear line sync or pre-/post-equalization pulses (see Figure 21 to Figure 32). This mode of operation is called partial blanking and is selected by setting MR32 to 1. It allows the insertion of any VBI data (opened VBI) into the encoded output waveform. This data is present in the digitized incoming YCbCr data stream, for example. WSS data, CGMS, VPS, and so on. Alternatively, the entire VBI may be blanked (no VBI data inserted) on these lines by setting MR32 to 0.

Mode 0 (CCIR-656): Slave Option

(Timing Register 0 TR0 = X X X X X 0 0 0)

The ADV7174/ADV7179 is controlled by the SAV (start active video) and EAV (end active video) time codes in the pixel data. All timing information is transmitted using a 4-byte synchro-

nization pattern. A synchronization pattern is sent immediately before and after each line during active picture and retrace. Mode 0 is illustrated in Figure 20. The HSYNC, FIELD/VSYNC, and BLANK (if not used) pins should be tied high during this mode.

Mode 0 (CCIR-656): Master Option

(Timing Register 0 TR0 = X X X X X 0 0 1)

The ADV7174/ADV7179 generates H, V, and F signals required for the SAV and EAV time codes in the CCIR-656 standard. The H bit is output on the HSYNC pin, the V bit is output on the BLANK pin, and the F bit is output on the FIELD/VSYNC pin. Mode 0 is illustrated in Figure 21 (NTSC) and Figure 22 (PAL). The H, V, and F transitions relative to the video waveform are illustrated in Figure 23.

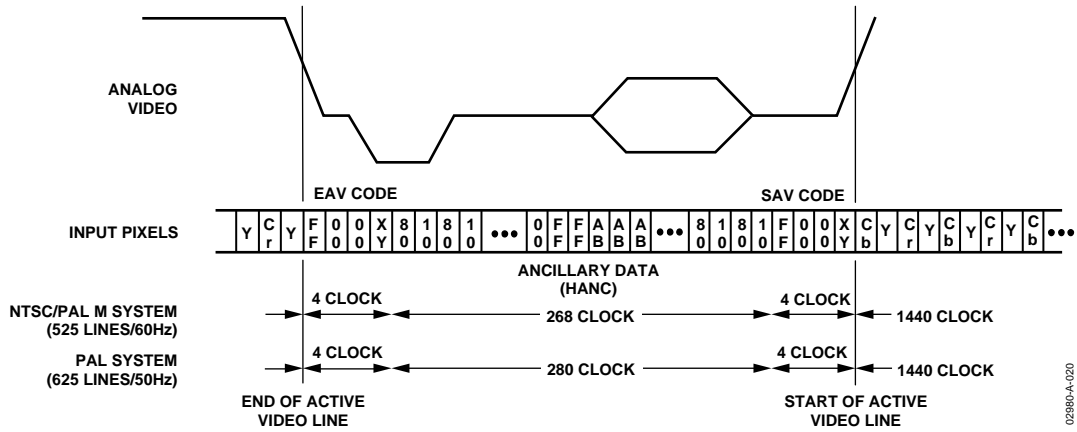

Figure 20. Timing Mode 0 (Slave Mode)

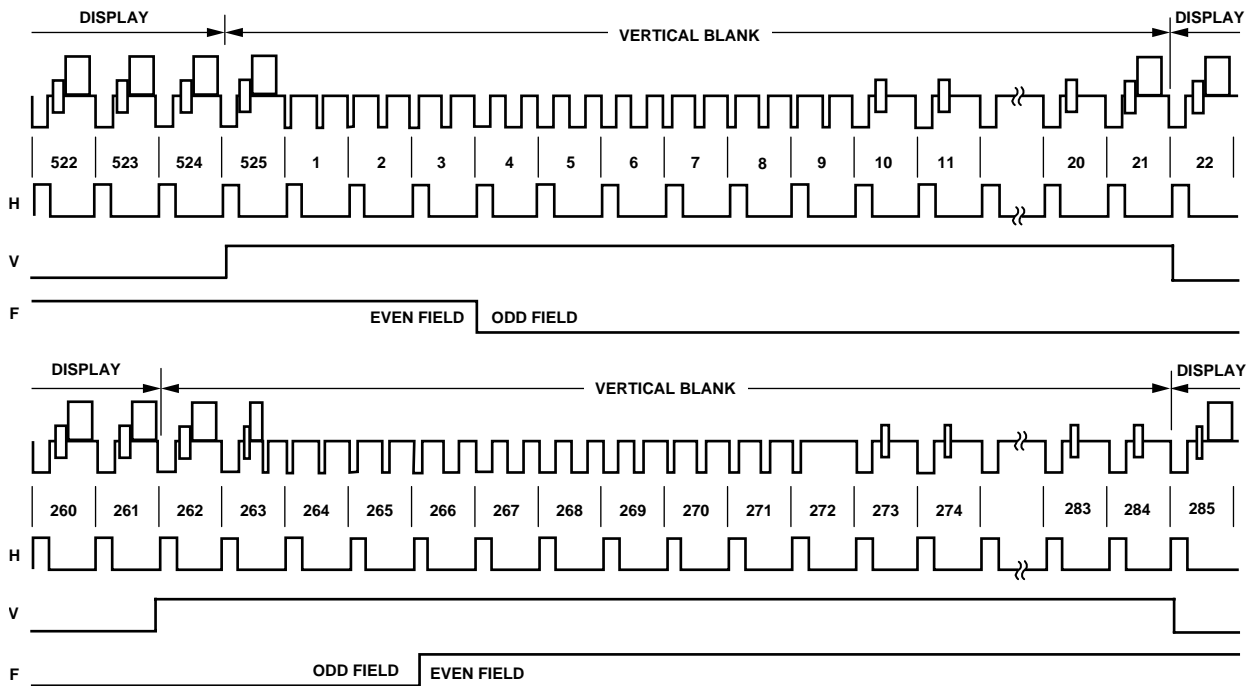

Figure 21. Timing Mode 0 (NTSC Master Mode)

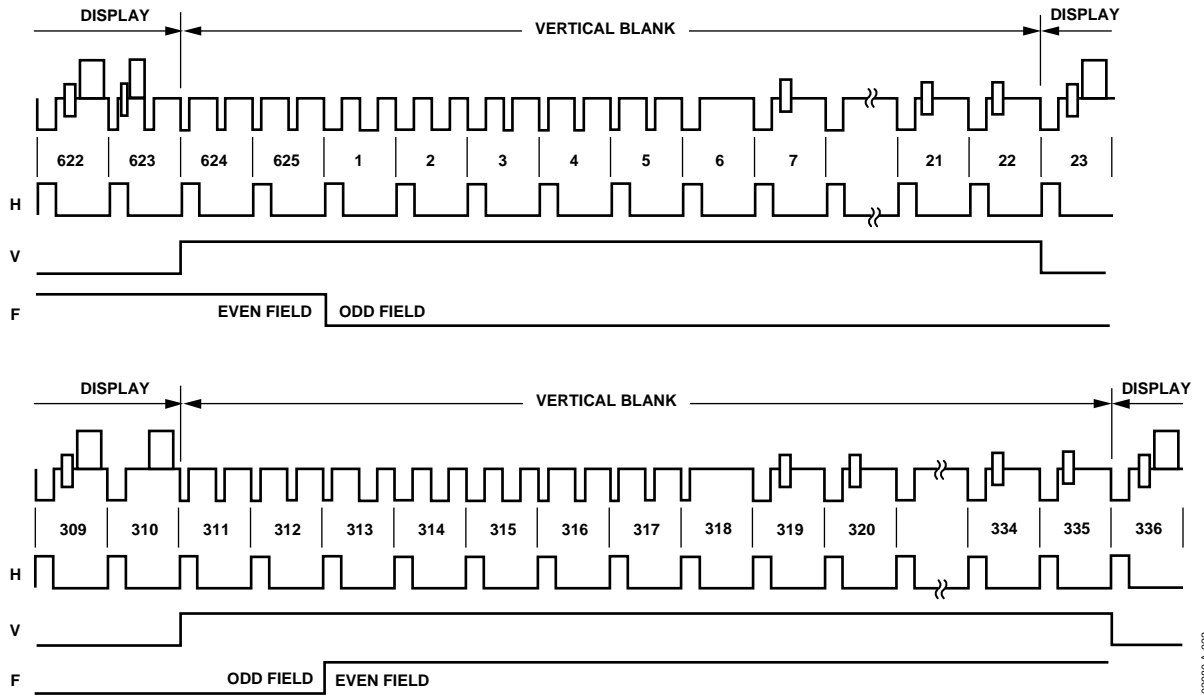

Figure 22. Timing Mode 0 (PAL Master Mode)

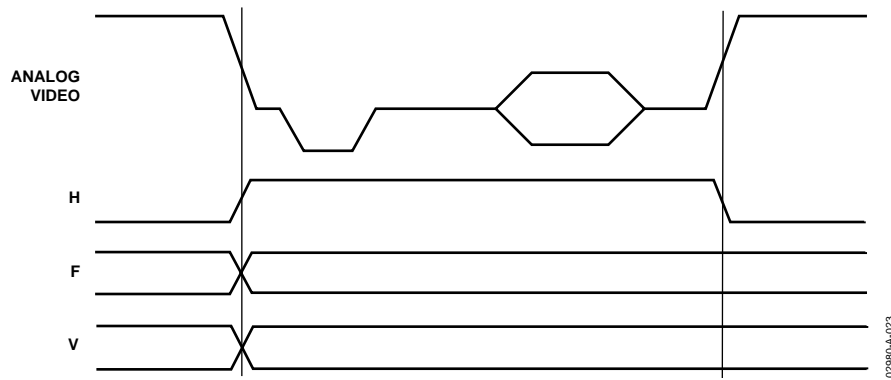

Figure 23. Timing Mode 0 Data Transitions (Master Mode)

ADV7174/ADV7179

Mode 1: Slave Option $\overline{\text{HSYNC}}$, $\overline{\text{BLANK}}$, FIELD

(Timing Register 0 TR0 = X X X X X 0 1 0)

In this mode, the ADV7174/ADV7179 accepts horizontal SYNC and odd/even FIELD signals. A transition of the FIELD input

when $\overline{\text{HSYNC}}$ is low indicates a new frame, i.e., vertical retrace. The $\overline{\text{BLANK}}$ signal is optional. When the $\overline{\text{BLANK}}$ input is disabled, the ADV7174/ADV7179 automatically blanks all normally blank lines as per CCIR-624. Mode 1 is illustrated in Figure 24 (NTSC) and Figure 25 (PAL).

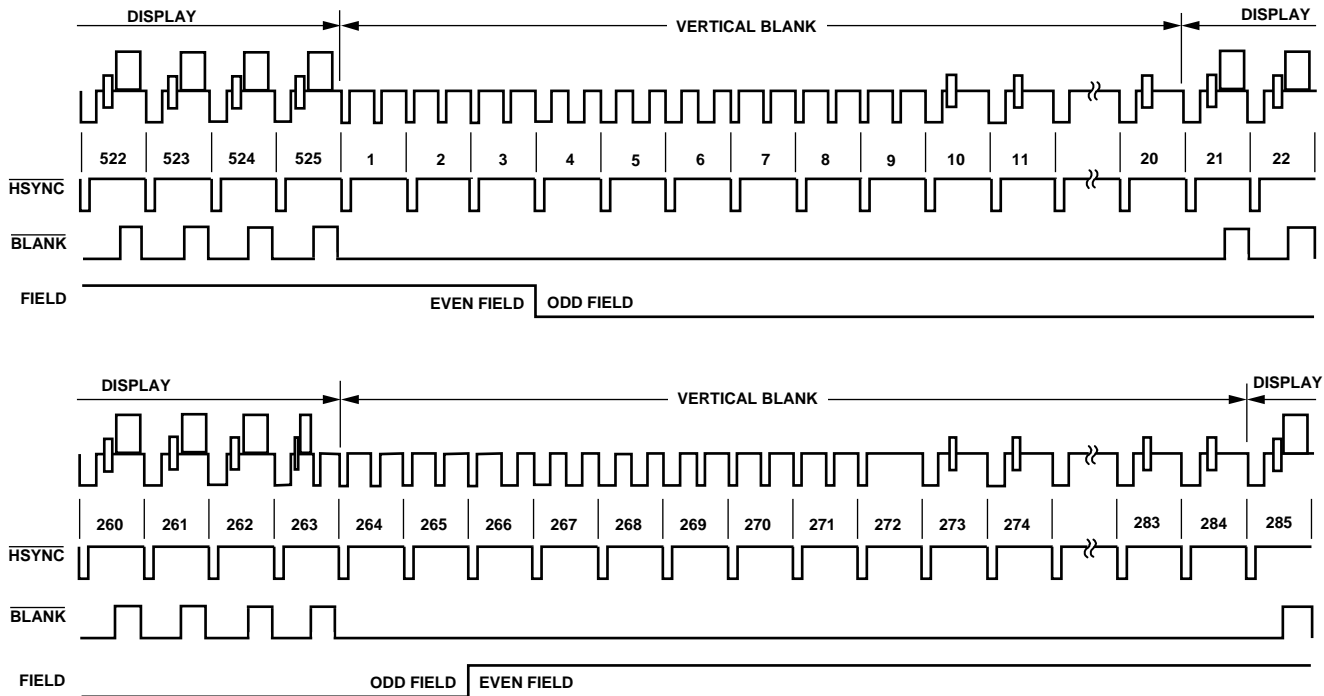

Figure 24. Timing Mode 1 (NTSC)

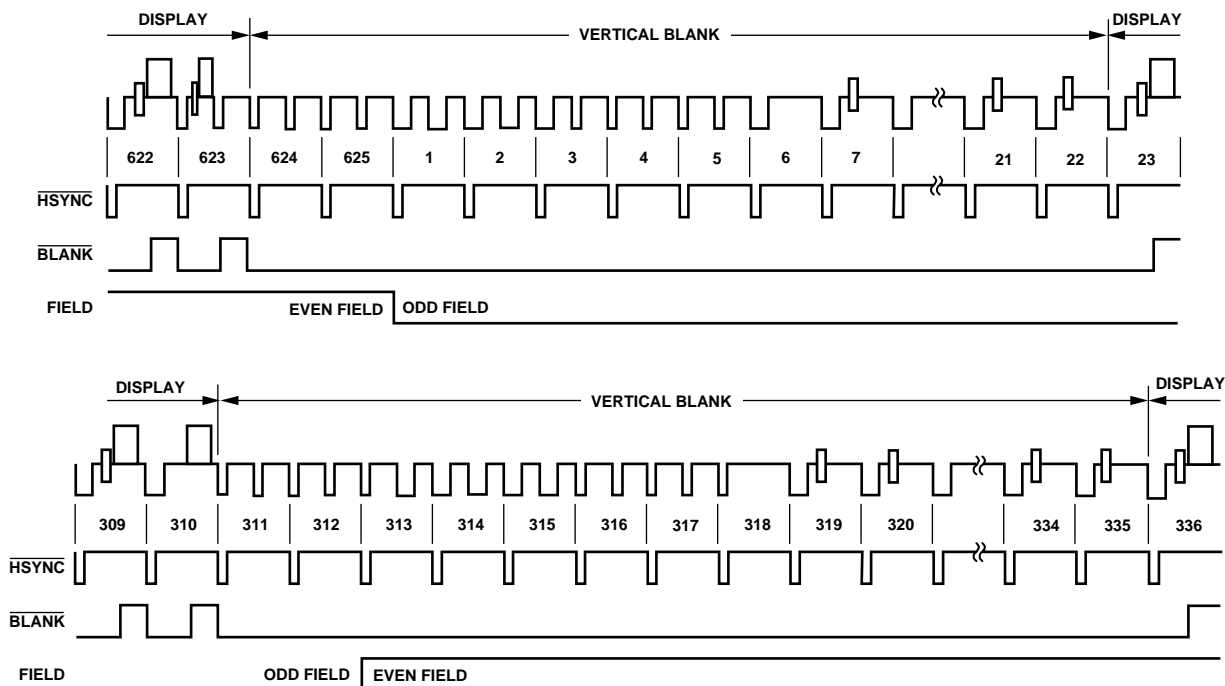

Figure 25. Timing Mode 1 (PAL)

Mode 1: Master Option \overline{HSYNC} , \overline{BLANK} , \overline{FIELD}

(Timing Register 0 TR0 = X X X X X 0 1 1)

In this mode, the ADV7174/ADV7179 can generate horizontal SYNC and odd/even FIELD signals. A transition of the FIELD input when \overline{HSYNC} is low indicates a new frame, i.e., vertical retrace. The BLANK signal is optional. When the BLANK input

is disabled, the ADV7174/ADV7179 automatically blanks all normally blank lines as per CCIR-624. Pixel data is latched on the rising clock edge following the timing signal transitions. Mode 1 is illustrated in Figure 24 (NTSC) and Figure 25 (PAL). Figure 26 illustrates the \overline{HSYNC} , \overline{BLANK} , and \overline{FIELD} for an odd or even field transition relative to the pixel data.

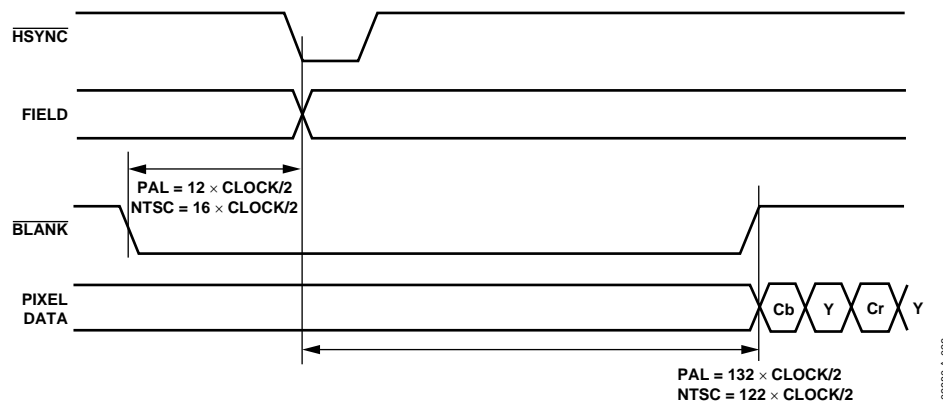

Figure 26. Timing Mode 1 Odd/Even Field Transitions Master/Slave

ADV7174/ADV7179

Mode 2: Slave Option \overline{HSYNC} , \overline{VSYNC} , \overline{BLANK}

(Timing Register 0 TR0 = X X X X X 1 0 0)

In this mode, the ADV7174/ADV7179 accepts horizontal and vertical SYNC signals. A coincident low transition of both \overline{HSYNC} and \overline{VSYNC} inputs indicates the start of an odd field. A \overline{VSYNC} low

transition when \overline{HSYNC} is high indicates the start of an even field. The \overline{BLANK} signal is optional. When the \overline{BLANK} input is disabled, the ADV7174/ADV7179 automatically blanks all normally blank lines as per CCIR-624. Mode 2 is illustrated in Figure 27 (NTSC) and Figure 28 (PAL).

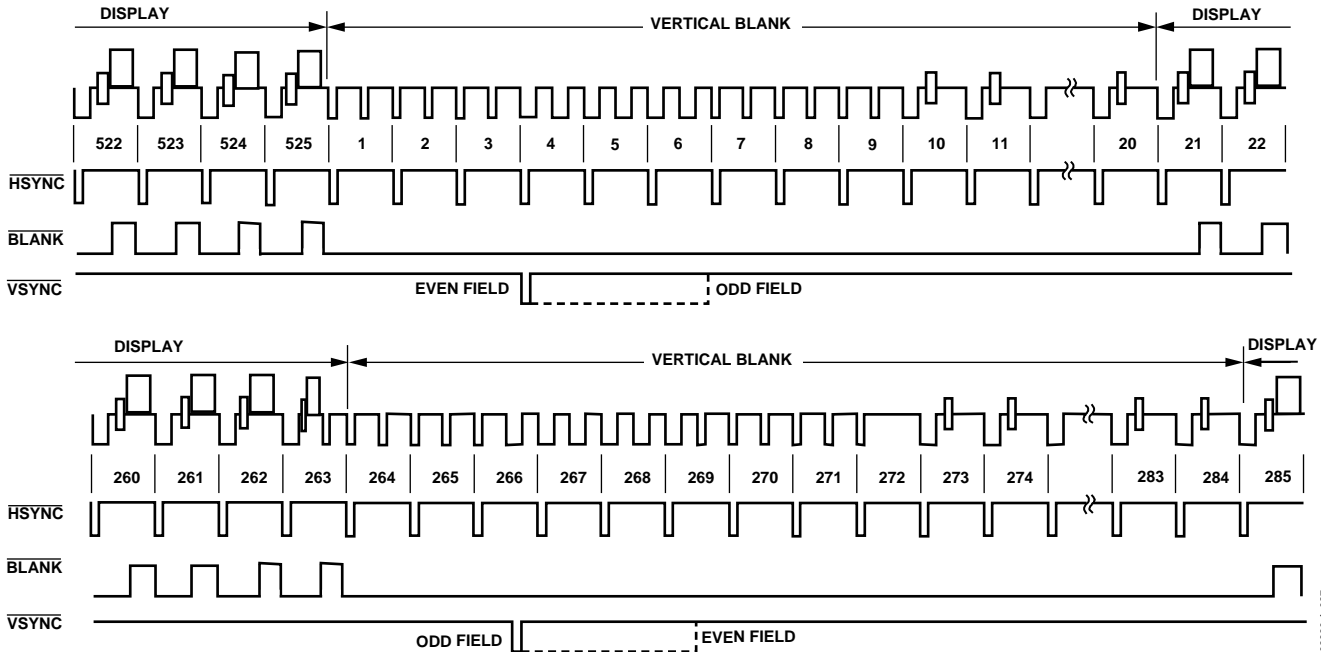

Figure 27. Timing Mode 2 (NTSC)

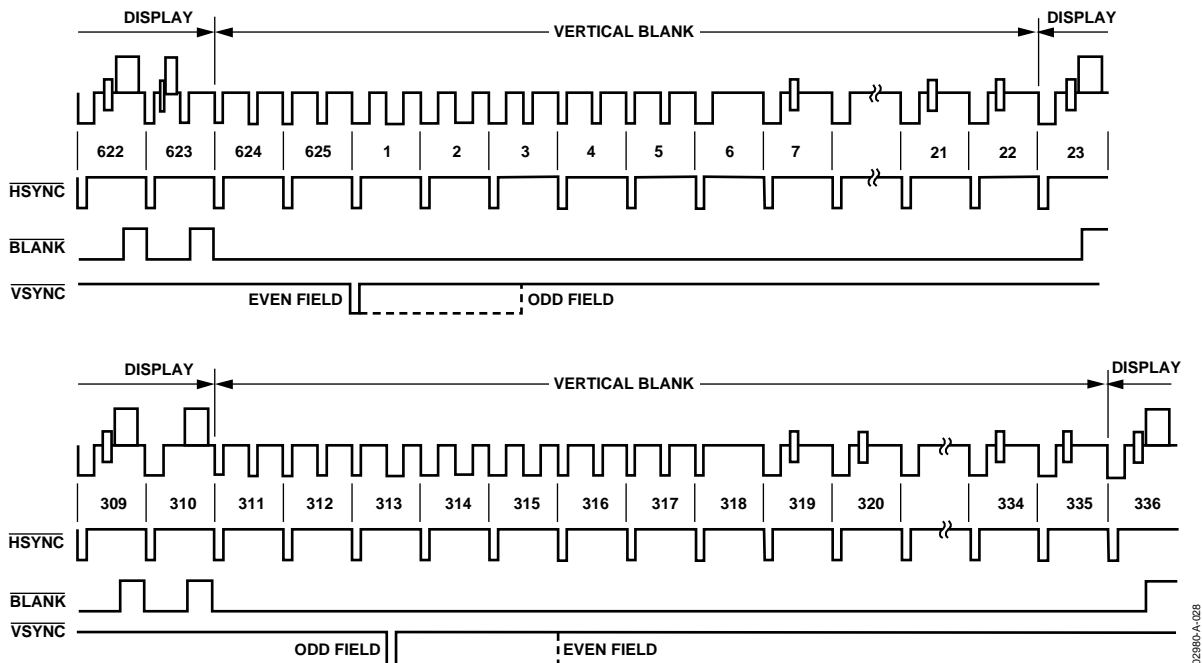

Figure 28. Timing Mode 2 (PAL)

Mode 2: Master Option \overline{HSYNC} , \overline{VSYNC} , \overline{BLANK}

(Timing Register 0 TR0 = X X X X X 1 0 1)

In this mode, the ADV7174/ADV7179 can generate horizontal and vertical SYNC signals. A coincident low transition of both \overline{HSYNC} and \overline{VSYNC} inputs indicates the start of an odd field. A \overline{VSYNC} low transition when \overline{HSYNC} is high indicates the start of an even field. The \overline{BLANK} signal is optional. When the

\overline{BLANK} input is disabled, the ADV7174/ADV7179 automatically blanks all normally blank lines as per CCIR-624. Mode 2 is illustrated in Figure 27 (NTSC) and Figure 28 (PAL). Figure 29 illustrates the \overline{HSYNC} , \overline{BLANK} , and \overline{VSYNC} for an even-to-odd field transition relative to the pixel data. Figure 30 illustrates the \overline{HSYNC} , \overline{BLANK} , and \overline{VSYNC} for an odd-to-even field transition relative to the pixel data.

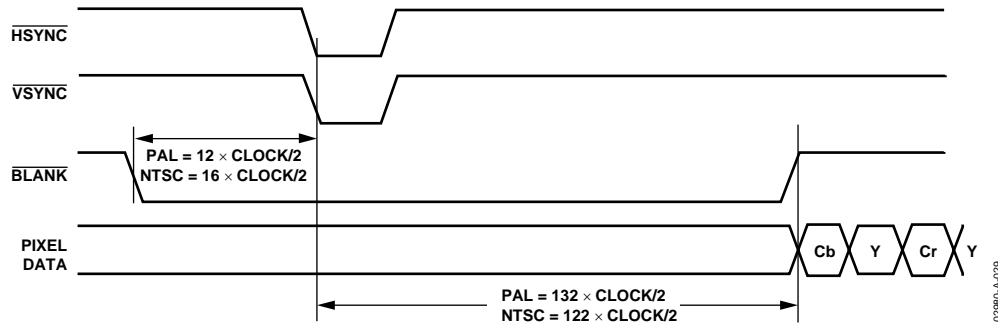

Figure 29. Timing Mode 2 Even-to-Odd Field Transition Master/Slave

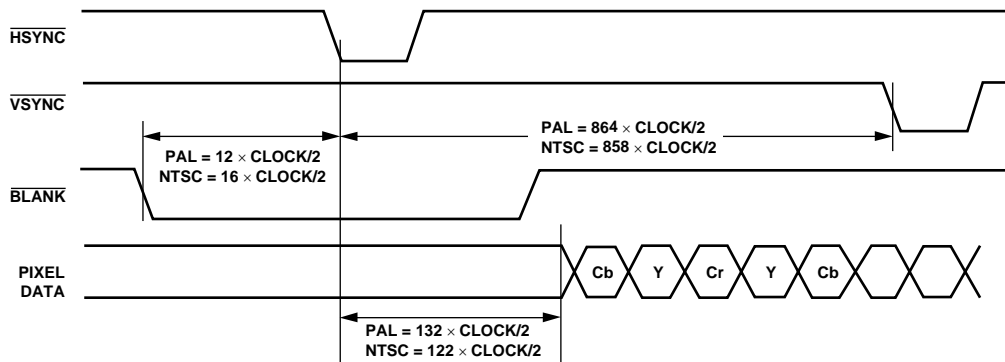

Figure 30. Timing Mode 2 Odd-to-Even Field Transition Master/Slave

ADV7174/ADV7179

Mode 3: Master/Slave Option HSYNC, BLANK, FIELD (Timing Register 0 TR0 = X X X X X 1 1 0 or X X X X X 1 1 1)

In this mode, the ADV7174/ADV7179 accepts or generates horizontal SYNC and odd/even FIELD signals. A transition of the FIELD input when HSYNC is high indicates a new frame,

that is, vertical retrace. The BLANK signal is optional. When the BLANK input is disabled, the ADV7174/ADV7179 automatically blanks all normally blank lines as per CCIR-624. Mode 3 is illustrated in Figure 31 (NTSC) and Figure 32 (PAL).

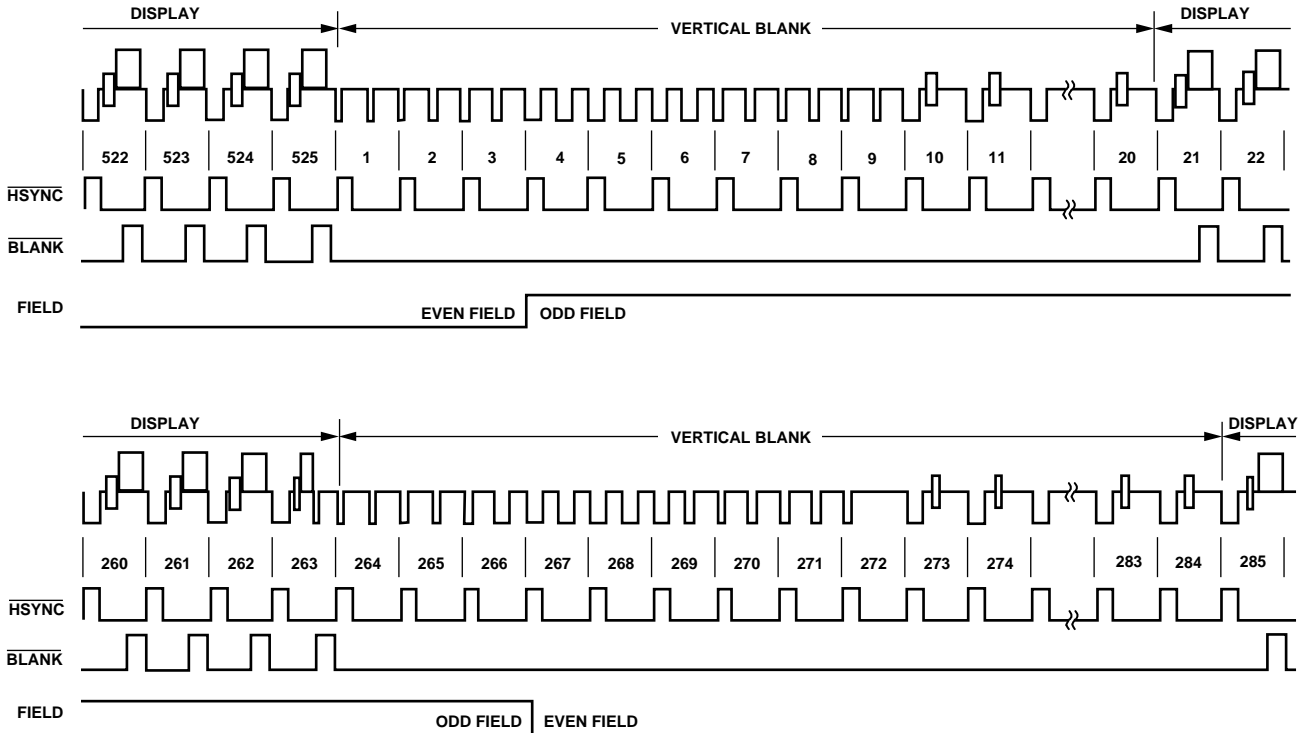

Figure 31. Timing Mode 3 (NTSC)

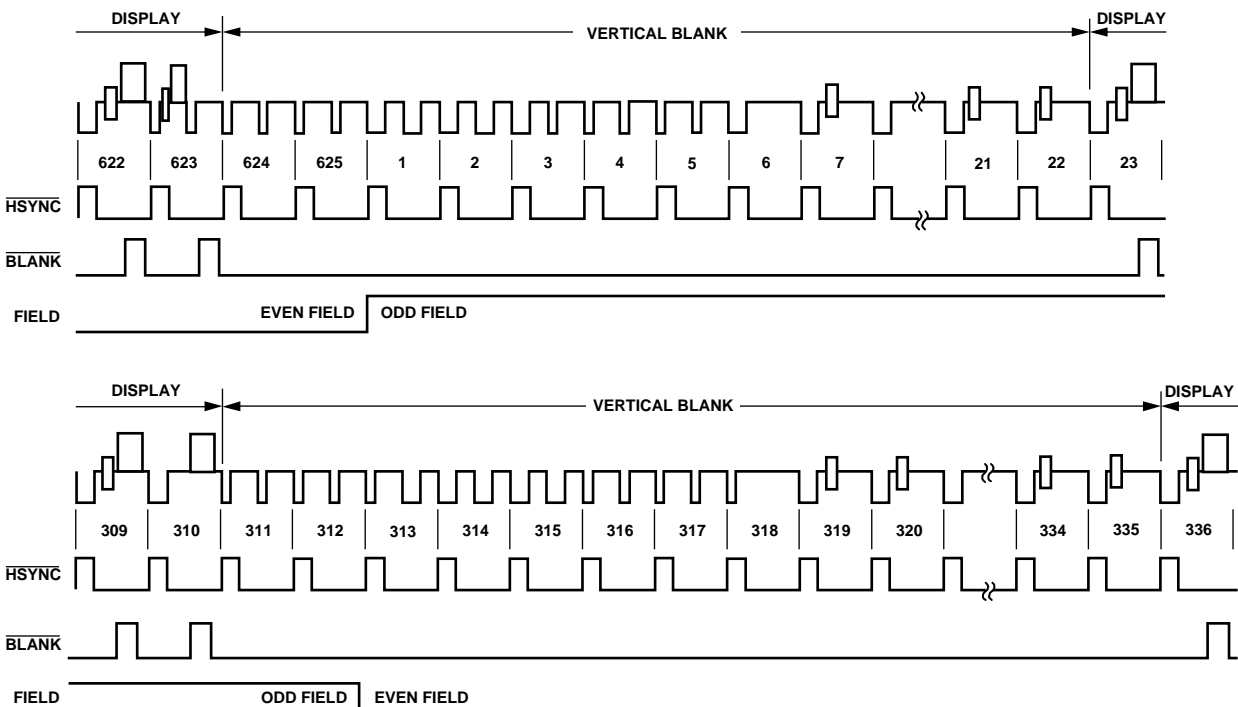

Figure 32. Timing Mode 3 (PAL)

POWER-ON RESET

After power-up, it is necessary to execute a reset operation. A reset occurs on the falling edge of a high-to-low transition on the **RESET** pin. This initializes the pixel port so that the pixel inputs, P7–P0, are selected. After reset, the ADV7174/ADV7179 is automatically set up to operate in NTSC mode. Subcarrier frequency code 21F07C16H is loaded into the subcarrier frequency registers. All other registers, with the exception of Mode Register 0, are set to 00H. With the exception of Bit MR44, all bits in Mode Register 0 are set to Logic 0. Bit MR44 of Mode Register 4 is set to Logic 1. This enables the 7.5 IRE pedestal.

SCH PHASE MODE

The SCH phase is configured in default mode to reset every four (NTSC) or eight (PAL) fields to avoid an accumulation of SCH phase error over time. In an ideal system, 0 SCH phase error would be maintained forever, but in reality, this is impossible to achieve due to clock frequency variations. This effect is reduced by the use of a 32-bit DDS, which generates this SCH.

Resetting the SCH phase every four or eight fields avoids the accumulation of SCH phase error and results in very minor SCH phase jumps at the start of the 4- or 8-field sequence.

Resetting the SCH phase should not be done if the video source does not have stable timing or the ADV7174/ADV7179 is configured in RTC mode (MR21 = 1 and MR22 = 1). Under these conditions (unstable video), the subcarrier phase reset should be enabled (MR22 = 0 and MR21 = 1), but no reset applied. In this configuration, the SCH phase can never be reset, which means that the output video can now track the unstable input video. The subcarrier phase reset, when applied, resets the SCH phase to Field 0 at the start of the next field, for example, subcarrier phase reset applied in Field 5 (PAL) on the start of the next field SCH phase is reset to Field 0.

MPU PORT DESCRIPTION

The ADV7174/ADV7179 supports a 2-wire serial (I²C compatible) microprocessor bus driving multiple peripherals. Two inputs, serial data (SDATA) and serial clock (SCLOCK), carry information between any device connected to the bus. Each slave device is recognized by a unique address. The ADV7174/ADV7179 has four possible slave addresses for both read and write operations. These are unique addresses for each device and are illustrated in Figure 33 and Figure 34. The LSB sets either a read or write operation. Logic 1 corresponds to a read operation, while Logic 0 corresponds to a write operation. A 1 is set by setting the ALSB pin of the ADV7174/ ADV7179 to Logic 0 or Logic 1.

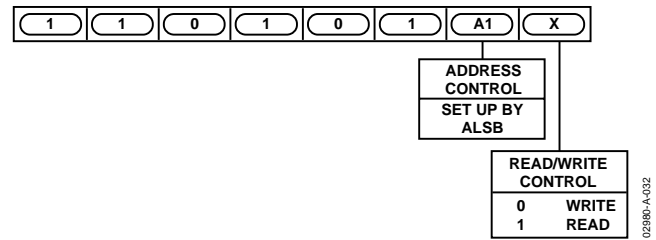

Figure 33. ADV7174 Slave Address

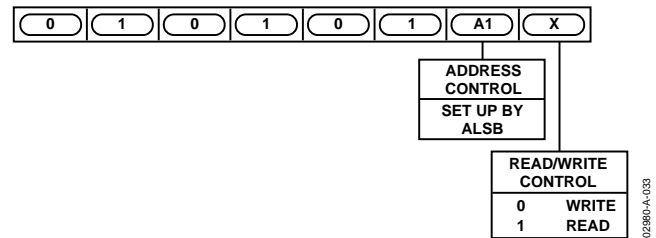

Figure 34. ADV7179 Slave Address

To control the various devices on the bus, the following protocol must be followed: first, the master initiates a data transfer by establishing a start condition, defined by a high-to-low transition on SDATA while SCLOCK remains high. This indicates that an address/data stream will follow. All peripherals respond to the start condition and shift the next eight bits (7-bit address + R/W bit). The bits transfer from MSB down to LSB. The peripheral that recognizes the transmitted address responds by pulling the data line low during the ninth clock pulse. This is known as an Acknowledge bit. All other devices withdraw from the bus at this point and maintain an idle condition. The idle condition is where the device monitors the SDATA and SCLOCK lines waiting for the start condition and the correct transmitted address. The R/W bit determines the direction of the data. A Logic 0 on the LSB of the first byte means that the master will write information to the peripheral. A Logic 1 on the LSB of the first byte means that the master will read information from the peripheral.

The ADV7174/ADV7179 acts as a standard slave device on the bus. The data on the SDATA pin is eight bits long, supporting the 7-bit addresses plus the R/W bit. The ADV7174/ADV7179 has 26 subaddresses to enable access to the internal registers. It therefore interprets the first byte as the device address and the second byte as the starting subaddress. The subaddresses' auto increment allows data to be written to or read from the starting subaddress. A data transfer is always terminated by a stop condition. The user can also access any unique subaddress register on a one-by-one basis without having to update all the registers. There is one exception. The subcarrier frequency registers should be updated in sequence, starting with Subcarrier Frequency Register 0. The auto increment function should then be used to increment and access Subcarrier Frequency Registers 1, 2, and 3. The subcarrier frequency registers should not be accessed independently.

ADV7174/ADV7179

Stop and start conditions can be detected at any stage during the data transfer. If these conditions are asserted out of sequence with normal read and write operations, they cause an immediate jump to the idle condition. During a given SCLOCK high period, the user should issue only one start condition, one stop condition, or a single stop condition followed by a single start condition. If an invalid subaddress is issued by the user, the ADV7174/ADV7179 cannot issue an acknowledge and returns to the idle condition. If in auto-increment mode the user exceeds the highest subaddress, the following action is taken:

1. In read mode, the highest subaddress register contents continues to be output until the master device issues a no-acknowledge. This indicates the end of a read. A no-acknowledge condition is when the SDATA line is not pulled low on the ninth pulse.
2. In write mode, the data for the invalid byte is not loaded into any subaddress register, a no-acknowledge is issued by the ADV7174/ADV7179, and the part returns to the idle condition.

Figure 35 illustrates an example of data transfer for a read sequence and the start and stop conditions.

Figure 36 shows bus write and read sequences.

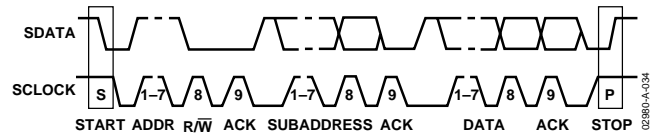

Figure 35. Bus Data Transfer

REGISTER ACCESSES

The MPU can write to or read from all of the ADV7174/ADV7179 registers except the subaddress register, which is a write-only register. The subaddress register determines which register the next read or write operation accesses. All communications with the part through the bus start with an access to the subaddress register. A read/write operation is performed from to the target address, which then increments to the next address until a stop command on the bus is performed.

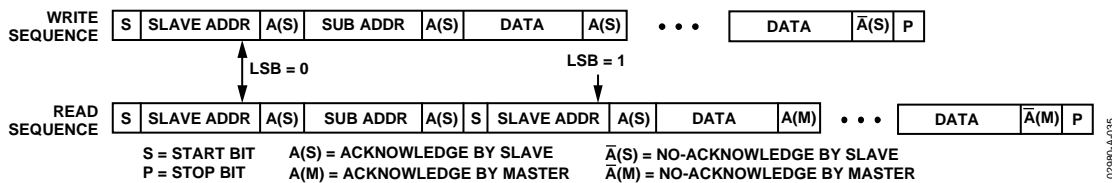

Figure 36. Write and Read Sequences

REGISTER PROGRAMMING

This section describes the configuration of each register, including the subaddress register, mode registers, subcarrier frequency registers, the subcarrier phase register, timing registers, closed captioning extended data registers, closed captioning data registers, and NTSC pedestal control registers.

SUBADDRESS REGISTER (SR7–SR0)

The communications register is an 8-bit write-only register. After the part has been accessed over the bus and a read/write operation is selected, the subaddress is set up. The subaddress register determines to/from which register the operation takes place.

Figure 37 shows the various operations under the control of the subaddress register. Zero should always be written to SR7–SR6.

REGISTER SELECT (SR5–SR0)

These bits are set up to point to the required starting address.

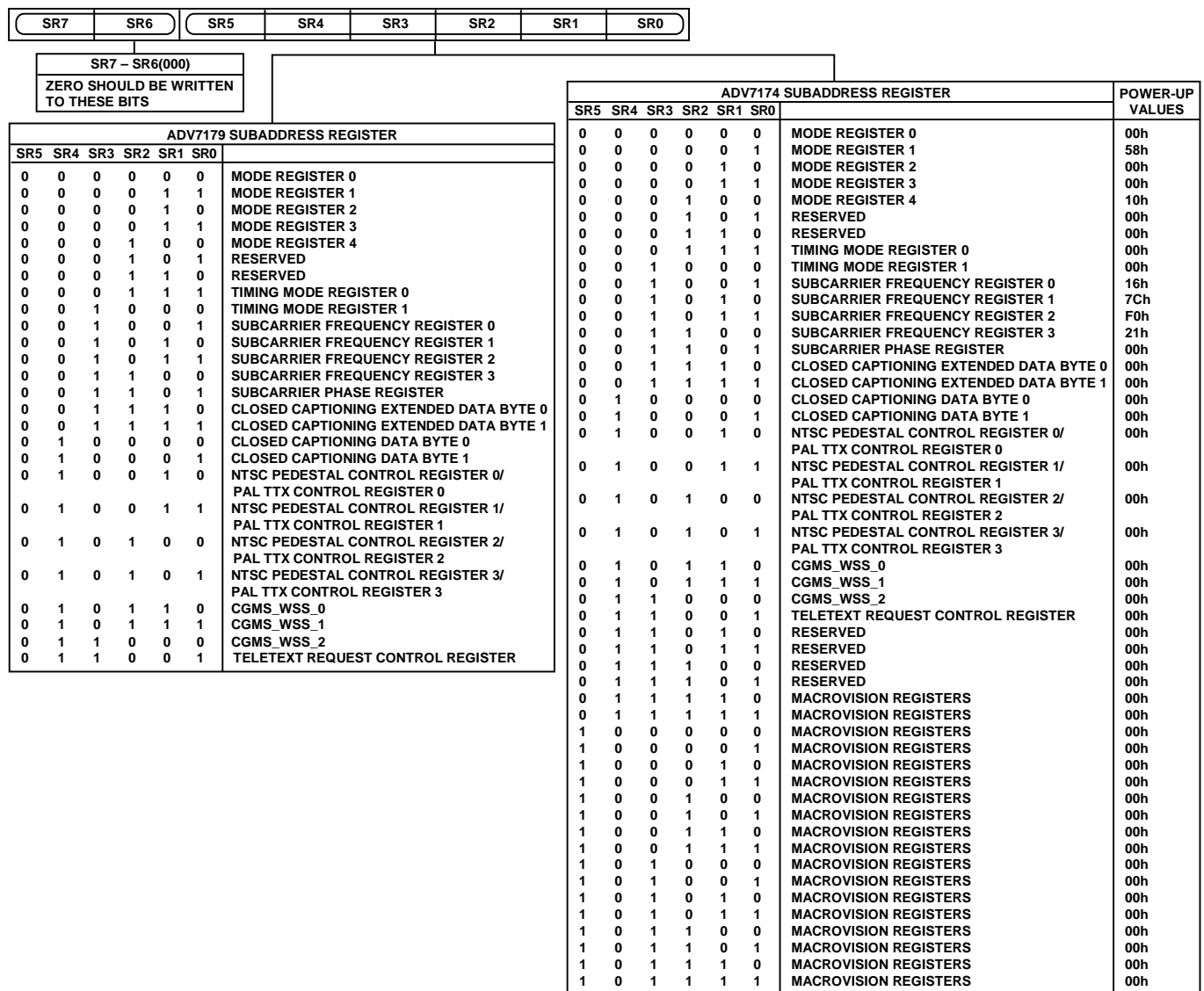

Figure 37. Subaddress Register Map

ADV7174/ADV7179

MODE REGISTER 0 (MR0)

Bits: MR07 – MR00
Address: SR4–SR0 = 00H

Figure 38 shows the various operations under the control of Mode Register 0. This register can be read from as well as written to.

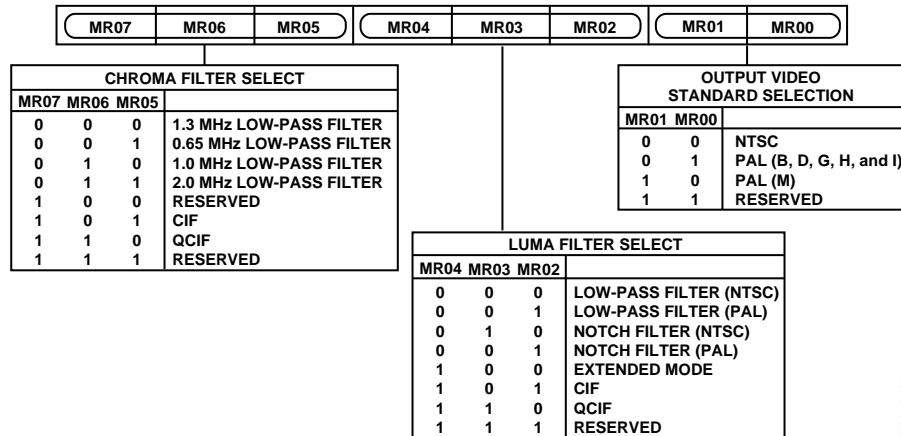

Figure 38. Mode Register 0

Table 9. MR0 Bit Description

Bit Name	Bit No.	Description
Output Video Standard Selection	MR01–MR00	These bits are used to set up the ENCODE mode. The ADV7174/ADV7179 can be set up to output NTSC, PAL (B/D/G/H/I), and PAL (M and N) standard video. PAL M is available on the ADV7174 only.
Luminance Filter Control	MR02–MR04	These bits specify which luminance filter is to be selected. The filter selection is made independent of whether PAL or NTSC is selected.
Chrominance Filter Control	MR05–MR07	These bits select the chrominance filter. A low-pass filter can be selected with a choice of cutoff frequencies 0.65 MHz, 1.0 MHz, 1.3 MHz, or 2 MHz, along with a choice of CIF or QCIF filters.

MODE REGISTER 1 (MR1)

Bits: MR17–MR10
 Address: SR4–SR0 = 01H

Figure 39 shows the various operations under the control of Mode Register 1. This register can be read from as well as written to.

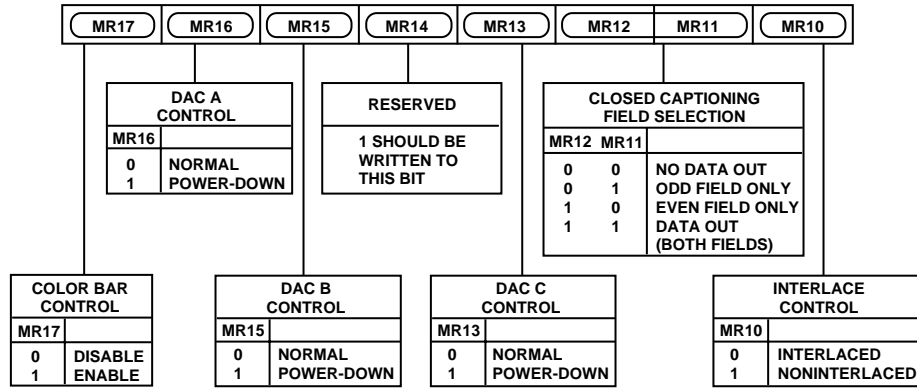

Figure 39. Mode Register 1

Table 10. MR1 Bit Description

Bit Name	Bit No.	Description
Interlace Control	MR10	This bit is used to set up the output to interlaced or noninterlaced mode. Power-down mode is relevant only when the part is in composite video mode.
Closed Captioning Field Selection	MR12–MR11	These bits control the fields on which closed captioning data is displayed; closed captioning information can be displayed on an odd field, even field, or both fields.
DAC Control	MR16–MR15 and MR13	These bits can be used to power down the DACs. Power-down can be used to reduce the power consumption of the ADV7174/ADV7179 if any of the DACs are not required in the application.
Reserved	MR14	A Logic 1 must be written to this register.
Color Bar Control	MR17	This bit can be used to generate and output an internal color bar test pattern. The color bar configuration is 100/7.5/75/7.5 for NTSC and 100/0/75/0 for PAL. It is important to note that when color bars are enabled, the ADV7174/ADV7179 is configured in a master timing mode.

ADV7174/ADV7179

MODE REGISTER 2 (MR2)

Bits: MR27–MR20
Address: SR4–SR0 = 02H

Mode Register 2 is an 8-bit-wide register. Figure 40 shows the various operations under the control of Mode Register 2. This register can be read from as well as written to.

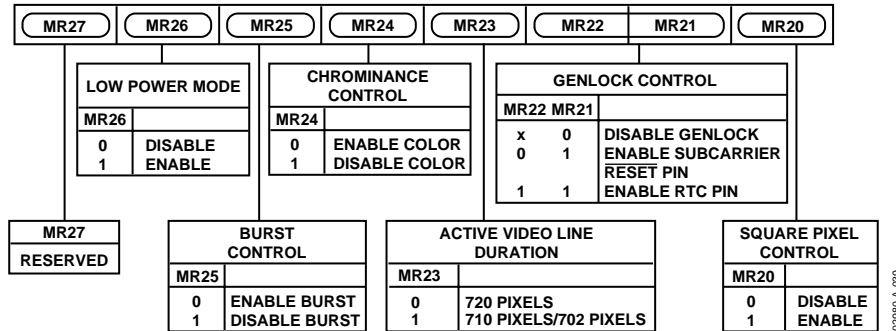

Figure 40. Mode Register 2

Table 11. MR2 Bit Description

Bit Name	Bit No.	Description
Square Pixel Control	MR20	This bit is used to set up square pixel mode. This is available in slave mode only. For NTSC, a 24.5454 MHz clock must be supplied. For PAL, a 29.5 MHz clock must be supplied.
Genlock Control	MR22–MR21	These bits control the genlock feature of the ADV7174/ ADV7179. Setting MR21 to Logic 1 configures the SCRESET/RTC pin as an input. Setting MR22 to Logic 0 configures the SCRESET/RTC pin as a subcarrier reset input. Therefore, the subcarrier will reset to Field 0 following a low-to-high transition on the SCRESET/RTC pin. Setting MR22 to Logic 1 configures the SCRESET/RTC pin as a real-time control input.
Active Video Line Duration	MR23	This bit switches between two active video line durations. A 0 selects CCIR REC601 (720 pixels PAL/NTSC), and a 1 selects ITU-R.BT470 standard for active video duration (710 pixels NTSC and 702 pixels PAL).
Chrominance Control	MR24	This bit enables the color information to be switched on and off the video output.
Burst Control	MR25	This bit enables the burst information to be switched on and off the video output.
Low Power Mode	MR26	This bit enables the lower power mode of the ADV7174/ADV7179. This reduces the DAC current by 45%.
Reserved	MR27	A Logic 0 must be written to this bit.

MODE REGISTER 3 (MR3)

Bits: MR37–MR30
 Address: SR4–SR0 = 03H

Mode Register 3 is an 8-bit-wide register. Figure 41 shows the various operations under the control of Mode Register 3.

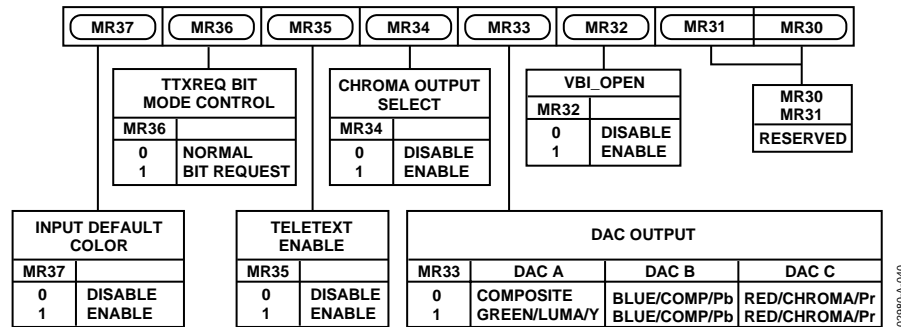

Figure 41. Mode Register 3

Table 12. MR3 Bit Description

Bit Name	Bit No.	Description
Revision Code	MR30–MR31	These bits are read-only and indicate the revision of the device.
VBI Open	MR32	This bit determines whether or not data in the vertical blanking interval (VBI) is output to the analog outputs or blanked. VBI data insertion is not available in Slave Mode 0. Also, when both BLANK input control and VBI open are enabled, BLANK input control has priority, i.e., VBI data insertion will not work.
DAC Output	MR33	This bit is used to switch the DAC outputs from SCART to a EUROSCART configuration. A complete list of all DAC output configurations is shown in Table 13.
Chroma Output Select	MR34	With this active high bit it is possible to output an extra chrominance signal C, on DAC A in any configuration that features a CVBS signal.
Teletext Enable	MR35	This bit must be set to 1 to enable Teletext data insertion on the TTX pin.
TTXREQ Bit Mode Control	MR36	This bit enables switching of the Teletext request signal from a continuous high signal (MR36 = 0) to a bitwise request signal (MR36 = 1).
Input Default Color	MR37	This bit determines the default output color from the DACs for zero input pixel data (or disconnected). A Logic 0 means that the color corresponding to 00000000 is displayed. A Logic 1 forces the output color to black for 00000000 pixel input video data.

Table 13. DAC Output Configuration Matrix

MR34	MR40	MR41	MR33	DAC A	DAC B	DAC C
0	0	0	0	CVBS	CVBS	C
0	0	0	1	Y	CVBS	C
0	0	1	0	CVBS	CVBS	C
0	0	1	1	Y	CVBS	C
0	1	0	0	CVBS	B	R
0	1	0	1	G	B	R
0	1	1	0	CVBS	Pb	Pr
0	1	1	1	Y	Pb	Pr
1	0	0	0	C	CVBS	C
1	0	0	1	Y	CVBS	C
1	0	1	0	C	CVBS	C
1	0	1	1	Y	CVBS	C
1	1	0	0	C	B	R
1	1	0	1	G	B	R
1	1	1	0	C	Pb	Pr
1	1	1	1	Y	Pb	Pr

CVBS: Composite Video Baseband Signal
 Y: Luminance Component Signal (For YPbPr or Y/C Mode)
 C: Chrominance Signal (For Y/C Mode)
 Pb: ColorComponent Signal (For YPbPr Mode)
 Pr: Color Component Signal (For YPbPr Mode)
 R: RED Component Video (For RGB Mode)
 G: GREEN Component Video (For RGB Mode)
 B: BLUE Component Video (For RGB Mode)

Each DAC can be powered on or off individually
 See MR1 Description and Figure 39.

ADV7174/ADV7179

MODE REGISTER 4 (MR4)

Bits: MR47–MR40
Address: SR4–SR0 = 04H

Mode Register 4 is an 8-bit-wide register. Figure 42 shows the various operations under the control of Mode Register 4.

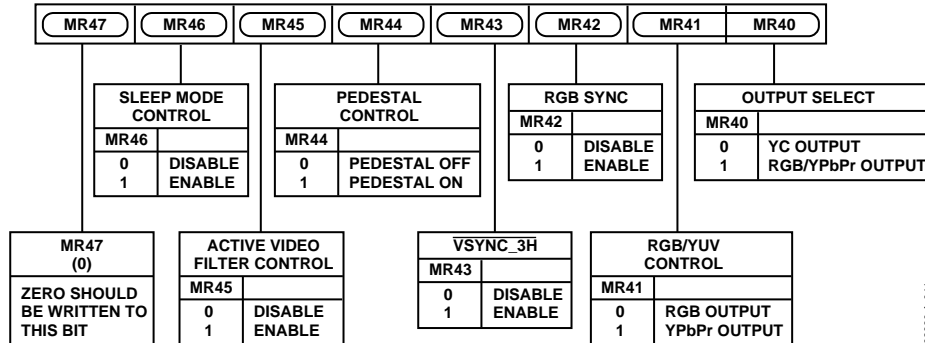

Figure 42. Mode Register 4

Table 14. MR4 Bit Description

Bit Name	Bit No.	Description
Output Select	MR40	This bit specifies if the part is in composite video or RGB/YPbPr mode.
RGB/YPbPr Control	MR41	This bit enables the output from the RGB DACs to be set to YPbPr output video standard.
RGB Sync	MR42	This bit is used to set up the RGB outputs with the sync information encoded on all RGB outputs.
$\overline{\text{VSYNC}}_{3\text{H}}$	MR43	When this bit is enabled (1) in slave mode, it is possible to drive the $\overline{\text{VSYNC}}$ active low input for 2.5 lines in PAL mode and three lines in NTSC mode. When this bit is enabled in master mode, the ADV7174/ADV7179 outputs an active low $\overline{\text{VSYNC}}$ signal for three lines in NTSC mode and 2.5 lines in PAL mode.
Pedestal Control	MR44	This bit specifies whether a pedestal is to be generated on the NTSC composite video signal. This bit is invalid if the ADV7174/ ADV7179 is configured in PAL mode.
Active Video Filter Control	MR45	This bit controls the filter mode applied outside the active video portion of the line. This filter ensures that the sync rise and fall times are always on spec regardless of which luma filter is selected. A Logic 1 enables this mode.
Sleep Mode Control	MR46	When this bit is set (1), sleep mode is enabled. With this mode enabled, the ADV7174/ADV7179 power consumption is reduced to typically 200 nA. The I ² C registers can be written to and read from when the ADV7174/ADV7179 is in sleep mode. If MR46 is set to a (0) when the device is in sleep mode, the ADV7174/ADV7179 comes out of sleep mode and resumes normal operation. Also, if the $\overline{\text{RESET}}$ signal is applied during sleep mode, the ADV7174/ADV7179 comes out of sleep mode and resumes normal operation.
Reserved	MR47	A Logic 0 should be written to this bit.

TIMING MODE REGISTER 0 (TR0)

Bits: TR07–TR00
 Address: SR4–SR0 = 07H

Figure 43 shows the various operations under the control of Timing Register 0. This register can be read from as well as written to.

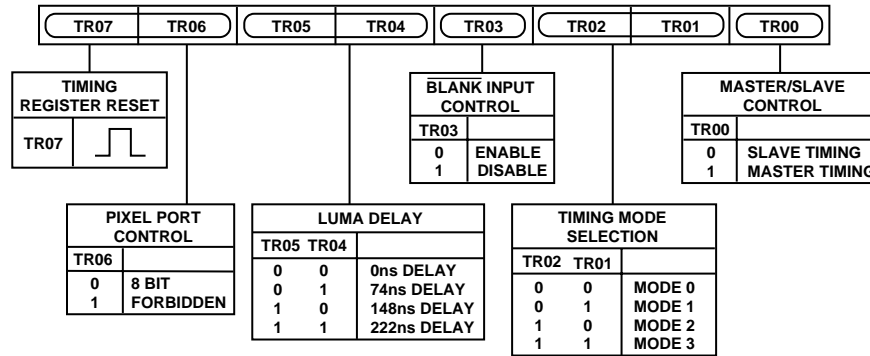

Figure 43. Timing Register 0

Table 15. TR0 Bit Description

Bit Name	Bit No.	Description
Master/Slave Control	TR00	This bit controls whether the ADV7174/ADV7179 is in master or slave mode.
Timing Mode Selection	TR02–TR01	These bits control the timing mode of the ADV7174/ADV7179. These modes are described in more detail in the 3.3 V Timing Specifications table.
BLANK Input Control	TR03	This bit controls whether the $\overline{\text{BLANK}}$ input is used when the part is in slave mode.
Luma Delay	TR05–TR04	These bits control the addition of a luminance delay. Each bit represents a delay of 74 ns.
Pixel Port Control	TR06	This bit is used to set the pixel port to accept 8-bit or YCrCb data on Pins P7–P0. 0 must be written here.
Timing Register Reset	TR07	Toggling the TR07 from low to high and to low again resets the internal timing counters. This bit should be toggled after power-up, reset, or changing to a new timing mode.

ADV7174/ADV7179

TIMING MODE REGISTER 1 (TR1)

Bits: TR17–TR10
Address: SR4–SR0 = 08H

Timing Register 1 is an 8-bit-wide register. Figure 44 shows the various operations under the control of Timing Register 1. This register can be read from as well written to. This register can be used to adjust the width and position of the master mode timing signals.

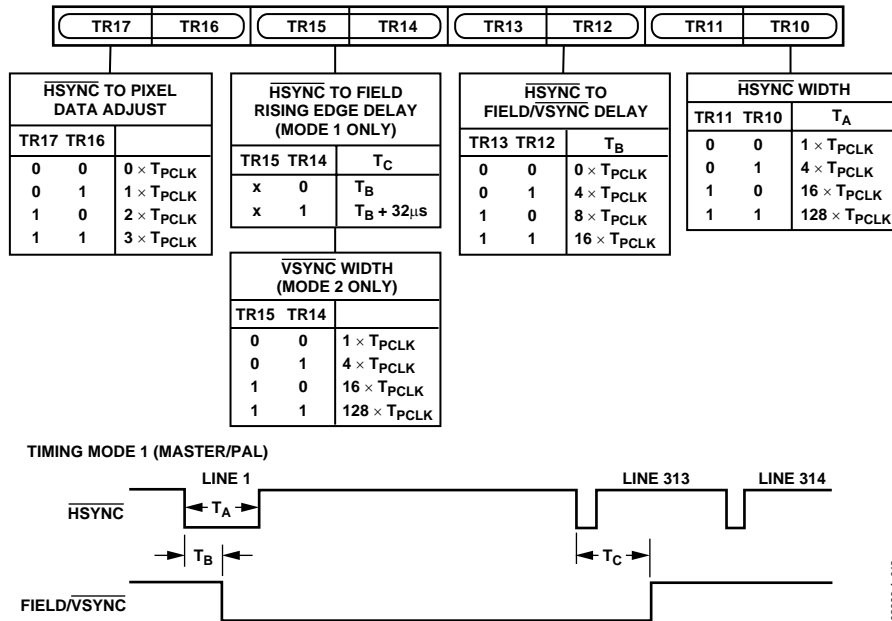

Figure 44. Timing Register 1

Table 16. TR1 Bit Description

Bit Name	Bit No.	Description
HSYNC Width	TR11–TR10	These bits adjust the HSYNC pulse width.
HSYNC to FIELD/VSYNC Delay	TR13–TR12	These bits adjust the position of the HSYNC output relative to the FIELD/VSYNC output.
HSYNC to FIELD Rising Edge Delay	TR15–TR14	When the ADV7174/ADV7179 is in Timing Mode 1, these bits adjust the position of the HSYNC output relative to the FIELD output rising edge.
VSYNC Width	TR15–TR14	When the ADV7174/ADV7179 is configured in Timing Mode 2, these bits adjust the VSYNC pulse width.
HSYNC to Pixel Data Adjust	TR17–TR16	This enables the HSYNC to be adjusted with respect to the pixel data. This allows the Cr and Cb components to be swapped. This adjustment is available in both master and slave timing modes.

SUBCARRIER FREQUENCY REGISTERS 3-0

Bits: FSC3-FSC0
 Address: SR4-SR00 = 09H-0CH

These 8-bit-wide registers are used to set up the subcarrier frequency. The value of these registers is calculated by using the following equation:

$$\frac{\text{No. of Subcarrier Frequency Values in One Line of Video Line}}{\text{No. of 27 MHz Clock Cycles in One Video Line}} \times 2^{32} *$$

* Rounded to the nearest integer.

For example, in NTSC mode,

$$\text{Subcarrier Frequency Value} = \frac{227.5}{1716} \times 2^{32} = 569408542d = 21F07C1Eh$$

Note that on power-up, F_{sc} Register 0 is set to 16h. A value of 1E as derived above is recommended.

Program as

- F_{sc} Register 0: 1EH
- F_{sc} Register 2: 7CH
- F_{sc} Register 3: F0H
- F_{sc} Register 4: 21H

Figure 45 shows how the frequency is set up by the four registers.

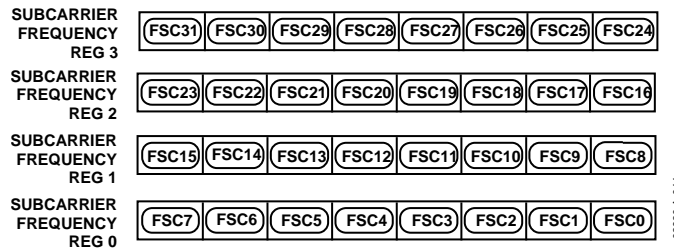

Figure 45. Subcarrier Frequency Register

SUBCARRIER PHASE REGISTER

Bits: FP7-FP0
 Address: SR4-SR0 = 0DH

This 8-bit-wide register is used to set up the subcarrier phase. Each bit represents 1.41°. For normal operation, this register is set to 00H.

CLOSED CAPTIONING EVEN FIELD DATA REGISTERS 1-0

Bits: CED15-CED0
 Address: SR4-SR0 = 0EH-0FH

These 8-bit-wide registers are used to set up the closed captioning extended data bytes on even fields. Figure 46 shows how the high and low bytes are set up in the registers.

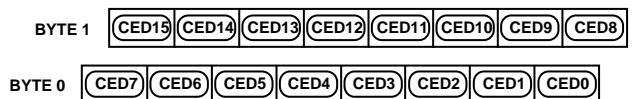

Figure 46. Closed Captioning Extended Data Register

CLOSED CAPTIONING ODD FIELD DATA REGISTERS 1-0

Bits: CCD15-CCD0
 Subaddress: SR4-SR0 = 10H-11H

These 8-bit-wide registers are used to set up the closed captioning data bytes on odd fields. Figure 47 shows how the high and low bytes are set up in the registers.



Figure 47. Closed Captioning Data Register

NTSC PEDESTAL/PAL TELETEXT CONTROL REGISTERS 3-0

Bits: PCE15-PCE0, PCO15-PCO0/TXE15-TXE0, TXO15-TXO0
 Subaddress: SR4-SR0 = 12H-15H

These 8-bit-wide registers are used to enable the NTSC pedestal/ PAL Teletext on a line-by-line basis in the vertical blanking interval for both odd and even fields. Figure 48 and Figure 49 show the four control registers. A Logic 1 in any of the bits of these registers has the effect of turning the pedestal off on the equivalent line when used in NTSC. A Logic 1 in any of the bits of these registers has the effect of turning Teletext on the equivalent line when used in PAL.

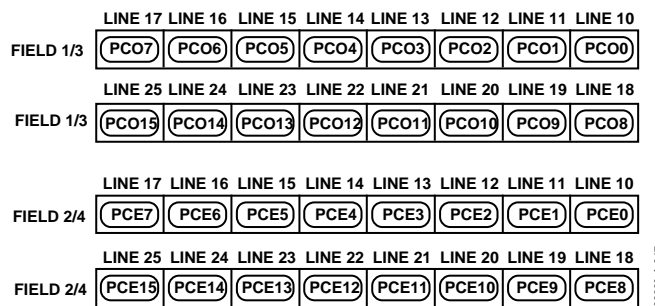

Figure 48. Pedestal Control Registers

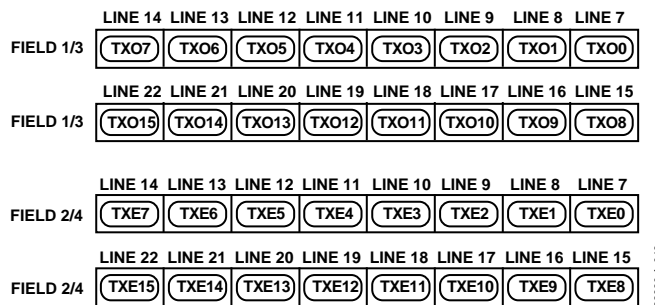

Figure 49. Teletext Control Registers

TELETEXT REQUEST CONTROL REGISTER (TC07)

Bits: TC07–TC00
 Address: SR4–SR0 = 19H

Teletext control register is an 8-bit-wide register (see Figure 50).

Table 17. Teletext Request Control Register

Bit Name	Bit No.	Description
TTXREQ Rising Edge Control	TC07–TC04	These bits control the position of the rising edge of TTXREQ. It can be programmed from 0 CLOCK cycles to a maximum of 15 CLOCK cycles (see Figure 50).
TTXREQ Falling Edge Control	TC03–TC00	These bits control the position of the falling edge of TTXREQ. It can be programmed from zero CLOCK cycles to a max of 15 CLOCK cycles. This controls the active window for Teletext data. Increasing this value reduces the amount of Teletext bits below the default of 360. If Bits TC03–TC00 are 00H when Bits TC07–TC04 are changed, the falling edge of TTXREQ tracks that of the rising edge, i.e., the time between the falling and rising edge remains constant (see Figure 49).

CGMS_WSS REGISTER 0 (C/W0)

Bits: C/W07–C/W00
 Address: SR4–SR0 = 16H

CGMS_WSS Register 0 is an 8-bit-wide register. Figure 51 shows the operations under the control of this register.

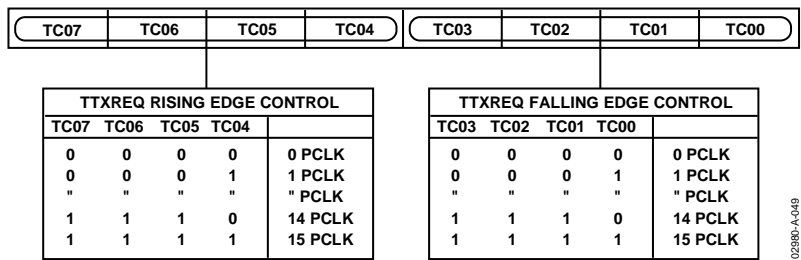

Figure 50. Teletext Control Register

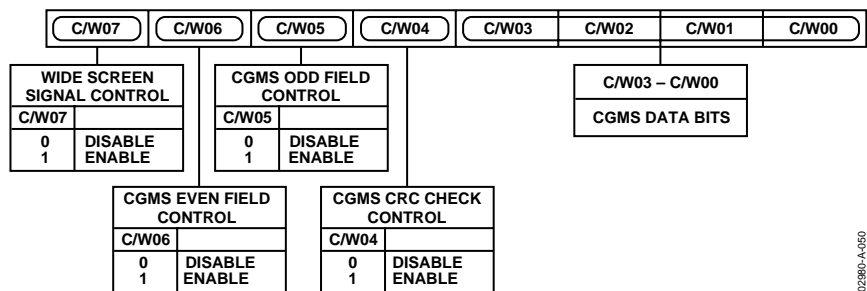

Figure 51. CGMS_WSS Register 0

Table 18. C/W0 Bit Description

Bit Name	Bit No.	Description
CGMS Data Bits	C/W03–C/W00	These four data bits are the final four bits of the CGMS data output stream. Note it is CGMS data ONLY in these bit positions, i.e., WSS data does not share this location.
CGMS CRC Check Control	C/W04	When this bit is enabled (1), the last six bits of the CGMS data, i.e., the CRC check sequence, are calculated internally by the ADV7174/ADV7179. If this bit is disabled (0), the CRC values in the register are output to the CGMS data stream.
CGMS Odd Field Control	C/W05	When this bit is set (1), CGMS is enabled for odd fields. Note this is only valid in NTSC mode.
CGMS Even Field Control	C/W06	When this bit is set (1), CGMS is enabled for even fields. Note this is only valid in NTSC mode.
WSS Control	C/W07	When this bit is set (1), wide screen signaling is enabled. Note this is only valid in PAL mode.

ADV7174/ADV7179

CGMS_WSS REGISTER 1 (C/W1)

Bits: C/W17–C/W10

Address : SR4–SR0 = 17H

CGMS_WSS Register 1 is an 8-bit-wide register. Figure 52 shows the operations under the control of this register.

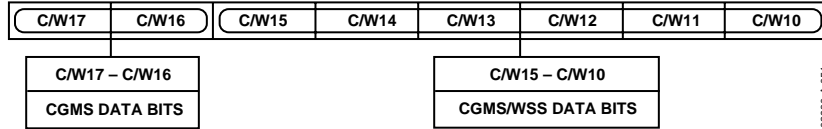

Figure 52. CGMS_WSS Register 1

Table 19. C/W1 Bit Description

Bit Name	Bit No.	Description
CGMS/WSS Data Bits	C/W15–C/W10	These bit locations are shared by CGMS data and WSS data. In NTSC mode, these bits are CGMS data. In PAL mode, these bits are WSS data.
CGMS Data Bits	C/W17–C/W16	These bits are CGMS data bits only.

CGMS_WSS REGISTER 2 (C/W2)

Bits: C/W27–C/W20

Address: (SR4–SR00) = 18H

CGMS_WSS Register 2 is an 8-bit-wide register. Figure 53 shows the operations under the control of this register.

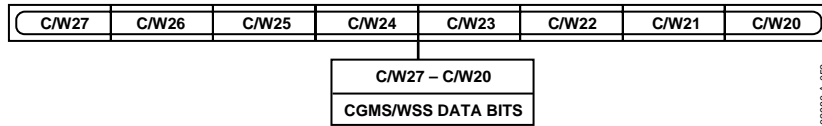

Figure 53. CGMS_WSS Register 2

Table 20. C/W2 Bit Description

Bit Name	Bit No.	Description
CGMS/WSS Data Bits	C/W27–C/W20	These bit locations are shared by CGMS data and WSS data. In NTSC mode, these bits are CGMS data. In PAL mode, these bits are WSS data.

APPENDIX 1—BOARD DESIGN AND LAYOUT CONSIDERATIONS

The ADV7174/ADV7179 is a highly integrated circuit containing both precision analog and high speed digital circuitry. It has been designed to minimize interference effects on the integrity of the analog circuitry by the high speed digital circuitry. It is imperative that these same design and layout techniques be applied to the system-level design so that high speed, accurate performance is achieved. Figure 54 shows the analog interface between the device and monitor.

The layout should be optimized for lowest noise on the ADV7174/ADV7179 power and ground lines by shielding the digital inputs and providing good decoupling. The lead length between groups of V_{AA} and GND pins should be minimized to reduce inductive ringing.

GROUND PLANES

The ground plane should encompass all ADV7174/ADV7179 ground pins, voltage reference circuitry, power supply bypass circuitry for the ADV7174/ADV7179, the analog output traces, and all the digital signal traces leading up to the ADV7174/ADV7179. The ground plane is the board's common ground plane.

POWER PLANES

The ADV7174/ADV7179 and any associated analog circuitry should have its own power plane, referred to as the analog power plane (V_{AA}). This power plane should be connected to the regular PCB power plane (V_{CC}) at a single point through a ferrite bead. This bead should be located within 3 inches of the ADV7174/ADV7179.

The metallization gap separating the device power plane and board power plane should be as narrow as possible to minimize the obstruction to the flow of heat from the device into the general board.

The PCB power plane should provide power to all digital logic on the PC board, and the analog power plane should provide power to all ADV7174/ADV7179 power pins and voltage reference circuitry.

Plane-to-plane noise coupling can be reduced by ensuring that portions of the regular PCB power and ground planes do not overlay portions of the analog power plane unless they can be arranged so that the plane-to-plane noise is common mode.

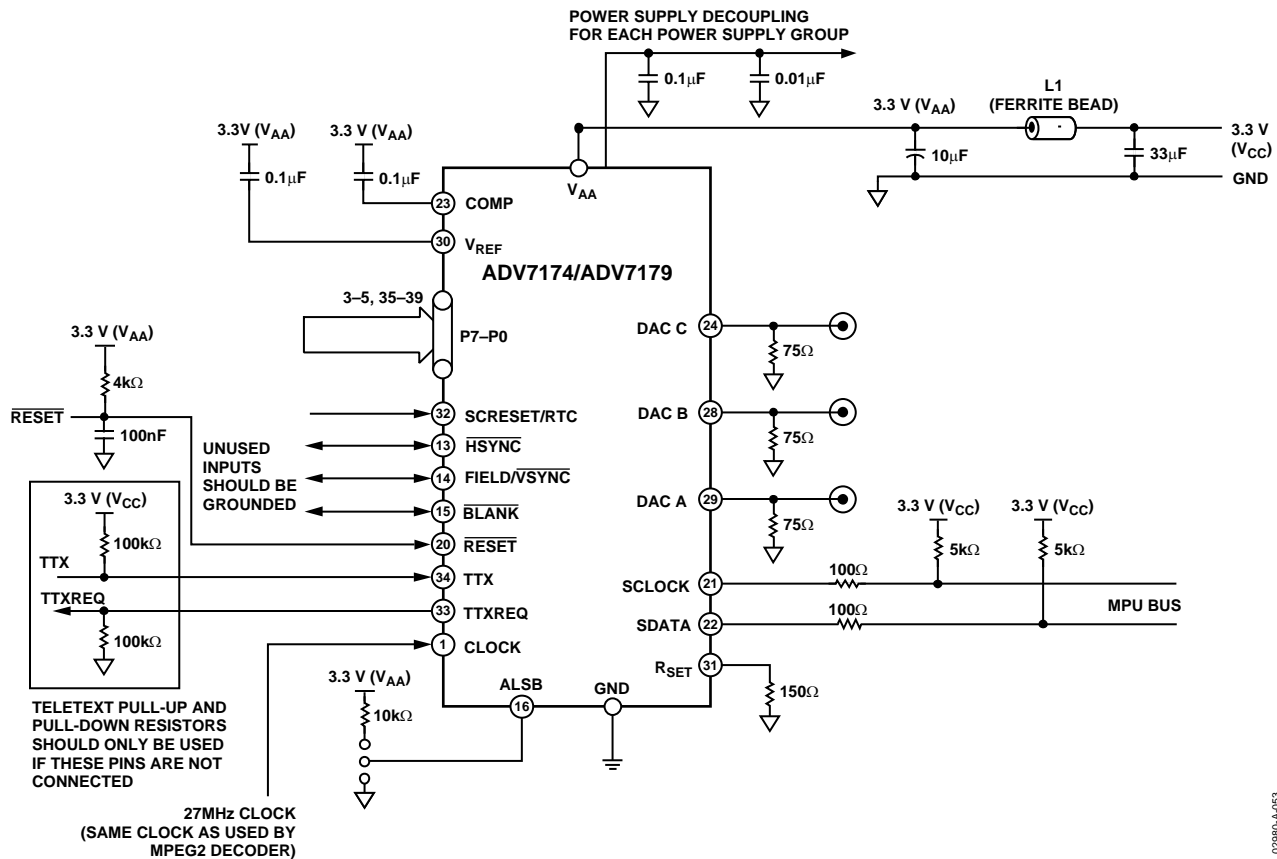

Figure 54. Recommended Analog Circuit Layout

SUPPLY DECOUPLING

For optimum performance, bypass capacitors should be installed using the shortest leads possible, consistent with reliable operation, to reduce the lead inductance. Best performance is obtained with 0.1 μF ceramic capacitor decoupling. Each group of V_{AA} pins on the ADV7174/ADV7179 must have at least one 0.1 μF decoupling capacitor to GND. These capacitors should be placed as close to the device as possible.

It is important to note that while the ADV7174/ADV7179 contains circuitry to reject power supply noise, this rejection decreases with frequency. If a high frequency switching power supply is used, the designer should pay close attention to reducing power supply noise and consider using a 3-terminal voltage regulator for supplying power to the analog power plane.

DIGITAL SIGNAL INTERCONNECT

The digital inputs to the ADV7174/ADV7179 should be isolated as much as possible from the analog outputs and other analog circuitry. Also, these input signals should not overlay the analog power plane.

Due to the high clock rates involved, long clock lines to the ADV7174/ADV7179 should be avoided to reduce noise pickup.

Any active termination resistors for the digital inputs should be connected to the regular PCB power plane (V_{CC}) and not to the analog power plane.

ANALOG SIGNAL INTERCONNECT

The ADV7174/ADV7179 should be located as close to the output connectors as possible to minimize noise pickup and reflections due to impedance mismatch.

The video output signals should overlay the ground plane, not the analog power plane, to maximize the high frequency power supply rejection.

Digital inputs, especially pixel data inputs and clocking signals, should never overlay any of the analog signal circuitry and should be kept as far away as possible.

For best performance, the outputs should each have a 75 Ω load resistor connected to GND. These resistors should be placed as close as possible to the ADV7174/ADV7179 to minimize reflections.

The ADV7174/ADV7179 should have no inputs left floating. Any inputs that are not required should be tied to ground.

The circuit in Figure 55 can be used to generate a 13.5 MHz waveform using the 27 MHz clock and the HSYNC pulse. This waveform is guaranteed to produce the 13.5 MHz clock in synchronization with the 27 MHz clock. This 13.5 MHz clock can be used if the 13.5 MHz clock is required by the MPEG decoder. This guarantees that the Cr and Cb pixel information is input to the ADV7174/ADV7179 in the correct sequence.

Note that the exposed metal paddle on the bottom side of the LFCSP package must be soldered to PCB ground for proper heat dissipation and also for electrical noise and mechanical strength benefits.

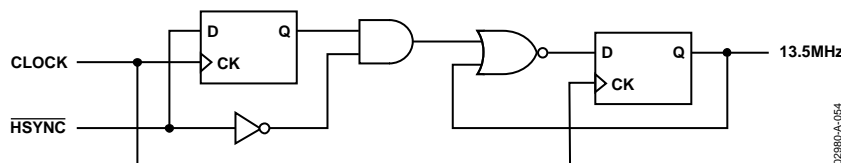

Figure 55. Circuit to Generate 13.5 MHz

02380-A-054

APPENDIX 2—CLOSED CAPTIONING

The ADV7174/ADV7179 supports closed captioning, conforming to the standard television synchronizing waveform for color transmission. Closed captioning is transmitted during the blanked active line time of Line 21 of the odd fields and Line 284 of even fields.

Closed captioning consists of a 7-cycle sinusoidal burst that is frequency-locked and phase-locked to the caption data. After the clock run-in signal, the blanking level is held for 2 data bits and is followed by a Logic 1 start bit. 16 bits of data follow the start bit. These consist of two 8-bit bytes, 7 data bits, and 1 odd parity bit. The data for these bytes is stored in closed captioning Data Registers 0 and 1.

The ADV7174/ADV7179 also supports the extended closed captioning operation, which is active during even fields, and is encoded on scan Line 284. The data for this operation is stored in closed captioning extended Data Registers 0 and 1.

All clock run-in signals and timing to support closed captioning on Lines 21 and 284 are automatically generated by the

ADV7174/ADV7179. All pixel inputs are ignored during Lines 21 and 284. FCC Code of Federal Regulations (CFR) 47 Section 15.119 and EIA-608 describe the closed captioning information for Lines 21 and 284.

The ADV7174/ADV7179 uses a single buffering method. This means that the closed captioning buffer is only one byte deep, therefore there will be no frame delay in outputting the closed captioning data unlike other 2-byte deep buffering systems. The data must be loaded at least one line before (Line 20 or Line 283) it is outputted on Line 21 and Line 284. A typical implementation of this method is to use $\overline{\text{VSYNC}}$ to interrupt a microprocessor, which in turn loads the new data (two bytes) every field. If no new data is required for transmission, you must insert zeros in both the data registers; this is called *nulling*. It is also important to load control codes, all of which are double bytes, on Line 21, or a TV cannot recognize them. If you have a message such as "Hello World," which has an odd number of characters, it is important to pad it out to an even number to get the end of the caption 2-byte control code to land in the same field.

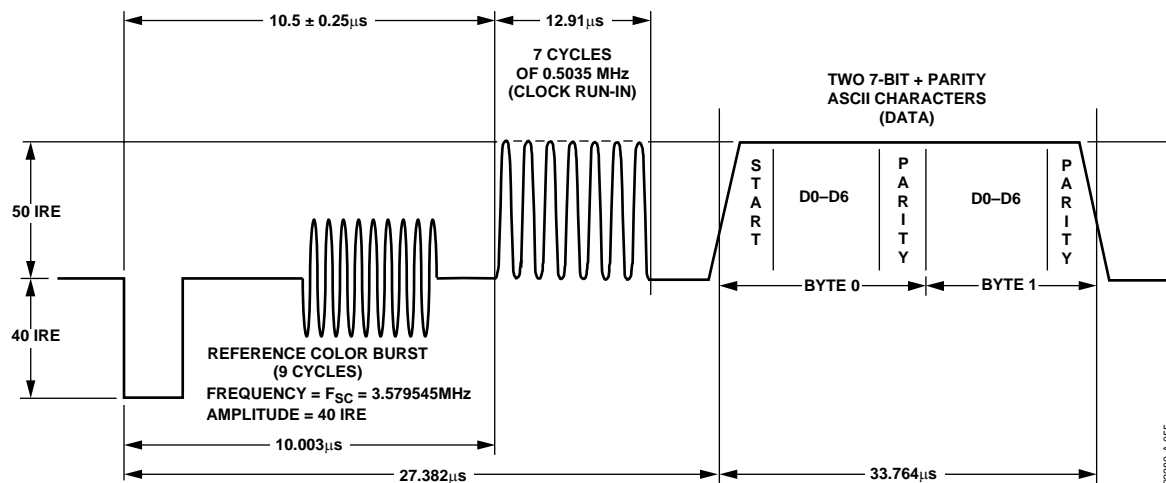

Figure 56. Closed Captioning Waveform (NTSC)

APPENDIX 3—COPY GENERATION MANAGEMENT SYSTEM (CGMS)

The ADV7174/ADV7179 supports the CGMS, conforming to the standard. CGMS data is transmitted on Line 20 of the odd fields and on Line 283 of the even fields. Bits C/W05 and C/W06 control whether or not CGMS data is output on odd and even fields. CGMS data can only be transmitted when the ADV7174/ ADV7179 is configured in NTSC mode. The CGMS data is 20 bits long, the function of each of these bits is as shown below. The CGMS data is preceded by a reference pulse of the same amplitude and duration as a CGMS bit (see Figure 57). The bits are output from the configuration registers in the following order: C/W00 = C16, C/W01 = C17, C/W02 = C18, C/W03 = C19, C/W10 = C8, C/ W11 = C9, C/W12 = C10, C/W13 = C11, C/W14 = C12, C/ W15 = C13, C/W16 = C14,

C/W17 = C15, C/W20 = C0, C/W21 = C1, C/W22 = C2, C/W23 = C3, C/W24 = C4, C/W25 = C5, C/W26 = C6, C/W27 = C7. If Bit C/W04 is set to a Logic 1, the last six bits, C19–C14, which comprise the 6-bit CRC check sequence, are calculated automatically on the ADV7174/ADV7179 based on the lower 14 bits (C0–C13) of the data in the data registers and output with the remaining 14 bits to form the complete 20 bits of the CGMS data. The calculation of the CRC sequence is based on the polynomial $X^6 + X + 1$ with a preset value of 111111. If C/W04 is set to a Logic 0, all 20 bits (C0–C19) are directly output from the CGMS registers (no CRC is calculated; it must be calculated by the user).

FUNCTION OF CGMS BITS

- Word 0 –6 Bits
- Word 1 –4 Bits
- Word 2 –4 Bits
- CRC –6 Bits CRC Polynomial = $X^6 + X + 1$ (Preset to 111111)

Table 21. Bit 1–Bit 14

Word	Bit	Function
Word 0	B1	Aspect Ratio 1 16:9 0 4:3
	B2	Display Format Letterbox Normal
	B3	Undefined
	B4, B5, B6	Identification information about video and other signals, for example, audio
Word 1	B7, B8, B9, B10	Identification signal incidental to Word 0
Word 2	B11, B12, B13, B14	Identification signal and information incidental to Word 0

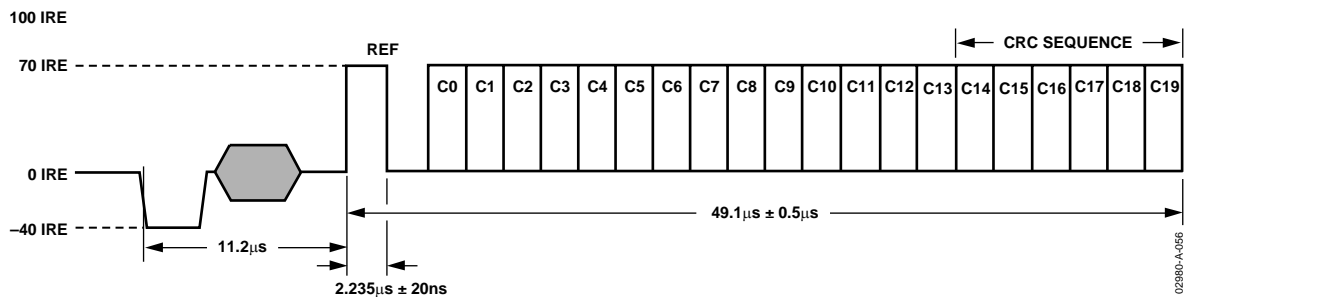

Figure 57. CGMS Waveform Diagram

APPENDIX 4—WIDE SCREEN SIGNALING (WSS)

The ADV7174/ADV7179 supports WSS, conforming to the standard. WSS data is transmitted on Line 23. WSS data can only be transmitted when the ADV7174/ ADV7179 is configured in PAL mode. The WSS data is 14 bits long, the function of each of these bits is as shown below. The WSS data is preceded by a run-in sequence and a start code (see Figure 58). The bits are output from the configuration registers in the

following order: C/W20 = W0, C/W21 = W1, C/W22 = W2, C/W23 = W3, C/W24 = W4, C/W25 = W5, C/W26 = W6, C/W27 = W7, C/W10 = W8, C/W11 = W9, C/W12 = W10, C/W13 = W11, C/W14 = W12, C/W15 = W13. If the Bit C/W07 is set to a Logic 1, it enables the WSS data to be transmitted on Line 23. The latter portion of Line 23 (42.5 μs from the falling edge of HSYNC) is available for the insertion of video.

FUNCTION OF WSS BITS

Table 22. Bit 0–Bit 2 Bit 3 is the odd parity check of Bit 0–Bit 2

B0	B1	B2	B3	Aspect Ratio	Format	Position
0	0	0	1	4:3	Full Format	Not Applicable
1	0	0	0	14:9	Letterbox	Center
0	1	0	0	14:9	Letterbox	Top
1	1	0	1	16:9	Letterbox	Center
0	0	1	0	16:9	Letterbox	Top
1	0	1	1	>16:9	Letterbox	Center
0	1	1	1	14:9	Full Format	Center
1	1	1	0	16:9	Not Applicable	Not Applicable

Table 23. Bit 4–Bit 7

Bit	Value	Description
B4	0	Camera Mode
	1	Film Mode
B5	0	Standard Coding
	1	Motion Adaptive Color Plus
B6	0	No Helper
	1	Modulated Helper
B7		Reserved
B8	0	No Teletext Subtitles
	1	Teletext Subtitles
B9–B10	0, 0	No Open Subtitles
	1, 0	Subtitles in Active Image Area
	0, 1	Subtitles out of Active Image Area
	1, 1	Reserved
B11	0	No Surround Sound Information
	1	Surround Sound Mode
B12		Reserved
B13		Reserved

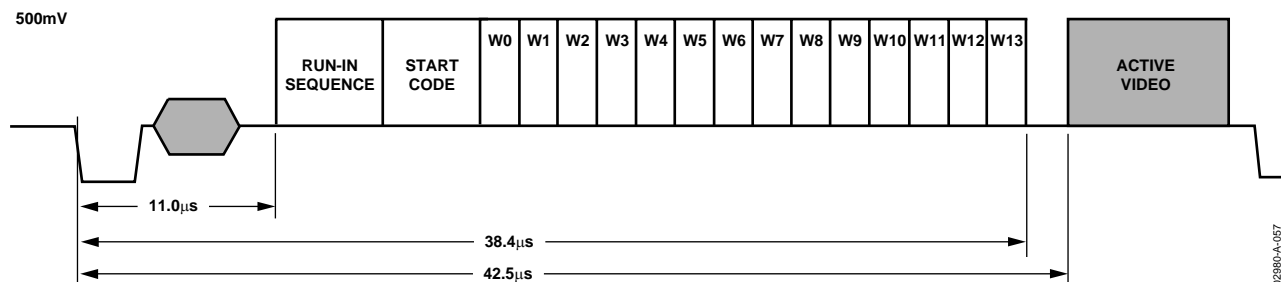

Figure 58. WSS Waveform Diagram

APPENDIX 5—TELETEXT

TELETEXT INSERTION

t_{PD} is the time needed by the ADV7174/ADV7179 to interpolate input data on TTX and insert it onto the CVBS or Y outputs, such that it appears $t_{SYNNTXOUT} = 10.2 \mu s$ after the leading edge of the horizontal signal. Time TTX_{DEL} is the pipeline delay time by the source that is gated by the TTXREQ signal in order to deliver TTX data.

With the programmability offered with the TTXREQ signal on the rising/falling edges, the TTX data is always inserted at the correct position of $10.2 \mu s$ after the leading edge of horizontal sync pulse, thus enabling a source interface with variable pipeline delays.

The width of the TTXREQ signal must always be maintained to allow the insertion of 360 (to comply with the Teletext standard PAL-WST) Teletext bits at a text data rate of 6.9375 Mbits/s. This is achieved by setting TC03–TC00 to 0. The insertion window is not open if the Teletext enable bit (MR35) is set to 0.

TELETEXT PROTOCOL

The relationship between the TTX bit clock (6.9375 MHz) and the system clock (27 MHz) for 50 Hz is

$$\left(\frac{27 \text{ MHz}}{4} \right) = 6.75 \text{ MHz}$$

$$\left(\frac{6.9375 \times 10^6}{6.75 \times 10^6} \right) = 1.027777$$

Thus, 37 TTX bits correspond to 144 clocks (27 MHz) and each bit has a width of almost four clock cycles. The ADV7174/ADV7179 uses an internal sequencer and variable phase interpolation filter to minimize the phase jitter and thus generate a band-limited signal that can be output on the CVBS and Y outputs.

At the TTX input, the bit duration scheme repeats after every 37 TTX bits or 144 clock cycles. The protocol requires that TTX Bits 10, 19, 28, and 37 are carried by three clock cycles and all other bits by four clock cycles. After 37 TTX bits, the next bits with three clock cycles are 47, 56, 65, and 74. This scheme holds for all following cycles of 37 TTX bits until all 360 TTX bits are completed. All Teletext lines are implemented in the same way. Individual control of Teletext lines is controlled by Teletext setup registers.

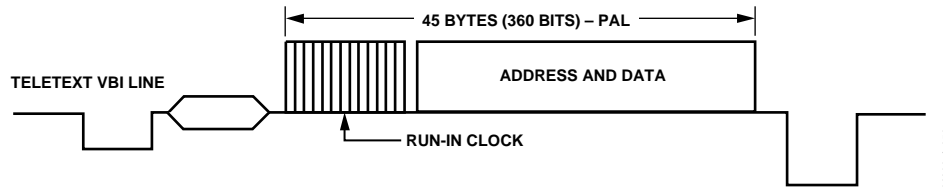

Figure 59. Teletext VBI Line

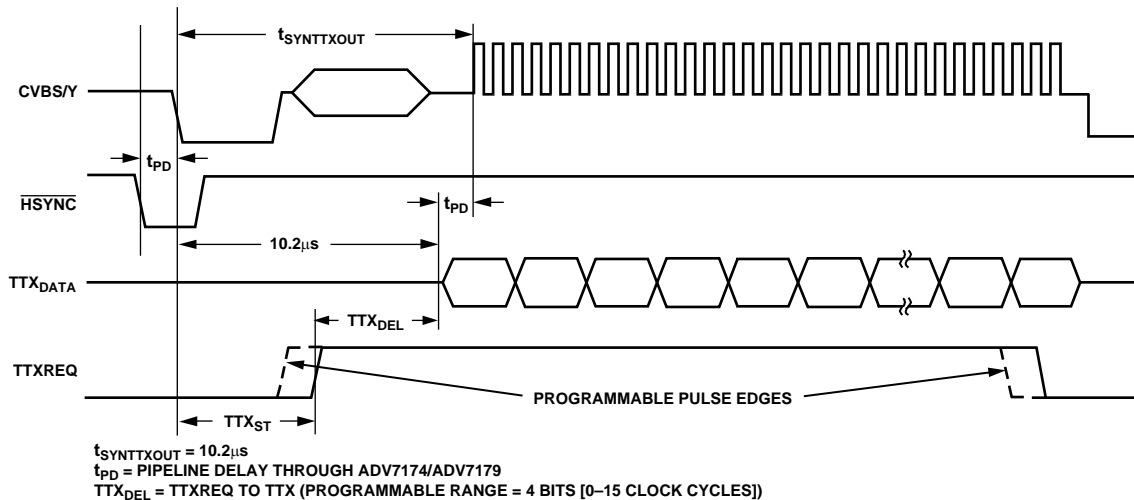

Figure 60. Teletext Functionality

APPENDIX 6—WAVEFORMS

NTSC WAVEFORMS (WITH PEDESTAL)

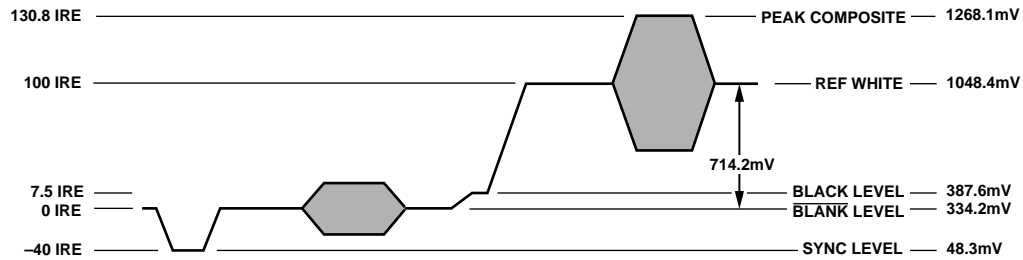

Figure 61. NTSC Composite Video Levels

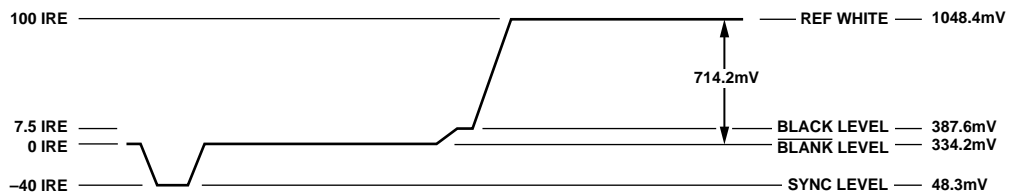

Figure 62. NTSC Luma Video Levels

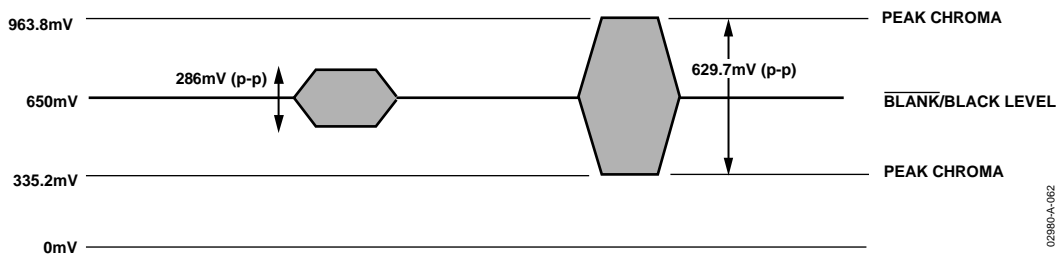

Figure 63. NTSC Chroma Video Levels



Figure 64. NTSC RGB Video Levels

NTSC WAVEFORMS (WITHOUT PEDESTAL)

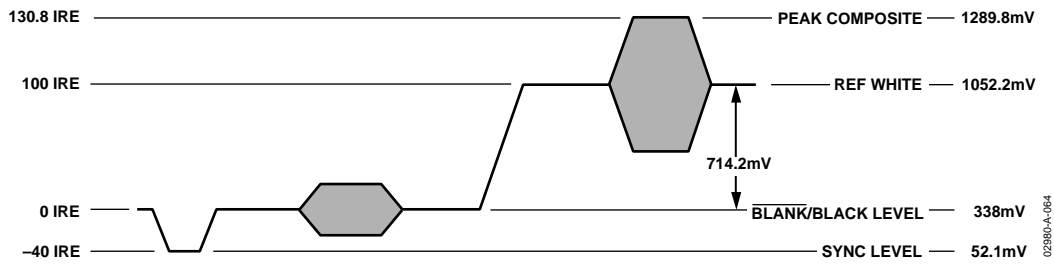

Figure 65. NTSC Composite Video Levels

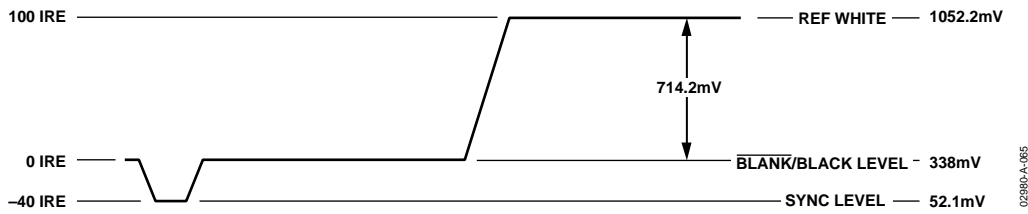

Figure 66. NTSC Luma Video Levels

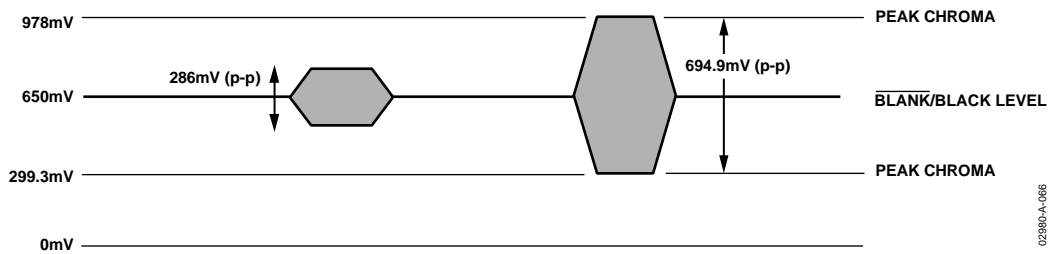

Figure 67. NTSC Chroma Video Levels

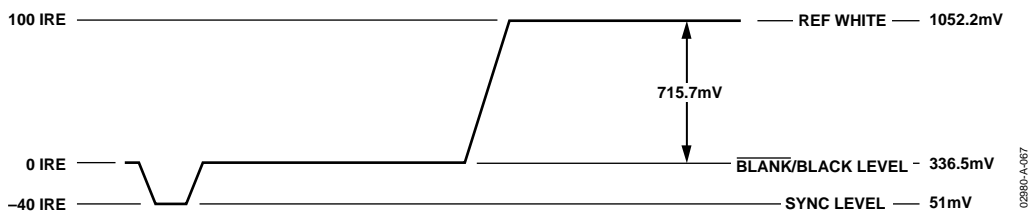

Figure 68. NTSC RGB Video Levels

PAL WAVEFORMS

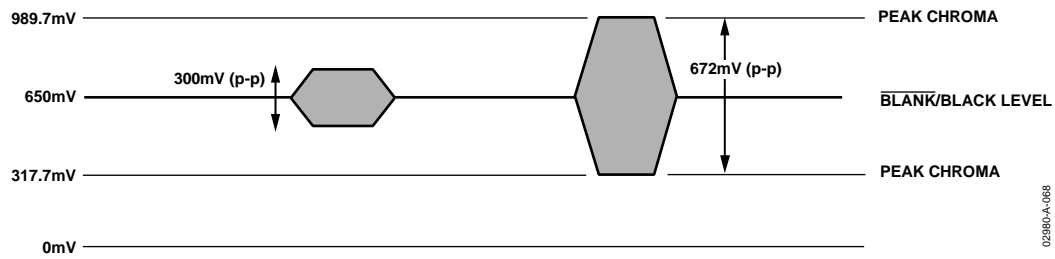

Figure 69. PAL Composite Video Levels

02880-A-068

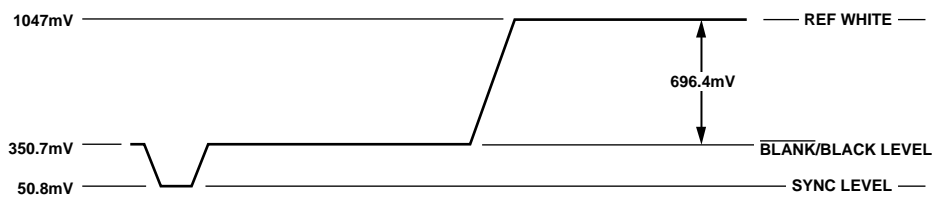

Figure 70. PAL Luma Video Levels

02880-A-069

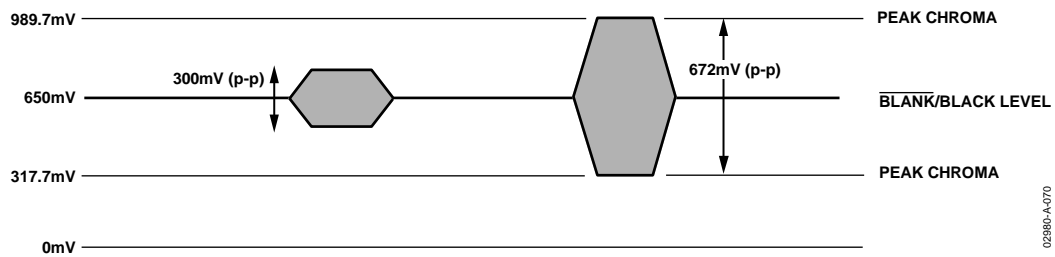

Figure 71. PAL Chroma Video Levels

02880-A-070

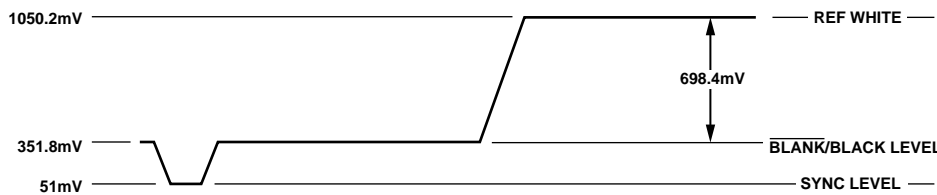

Figure 72. PAL RGB Video Levels

02880-A-071

Pb Pr WAVEFORMS

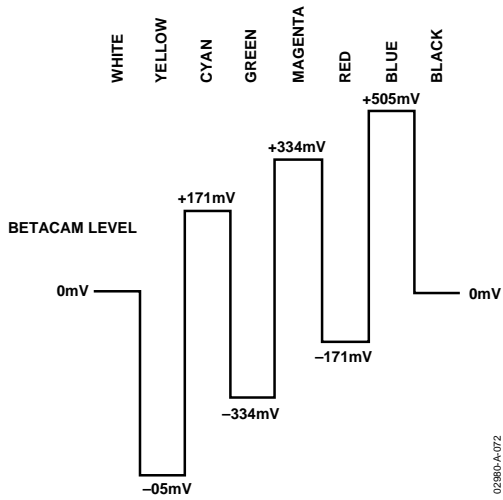

Figure 73. NTSC 100% Color Bars, No Pedestal Pb Levels

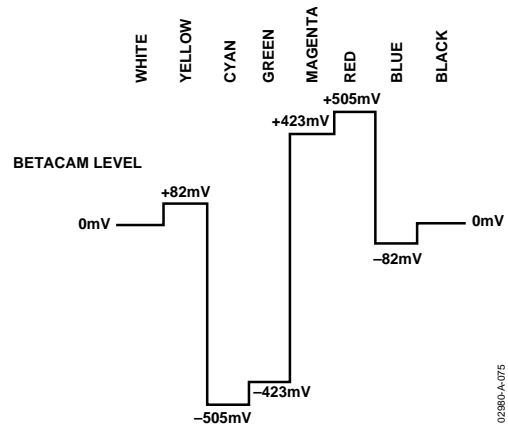

Figure 76. NTSC 100% Color Bars, No Pedestal Pr Levels

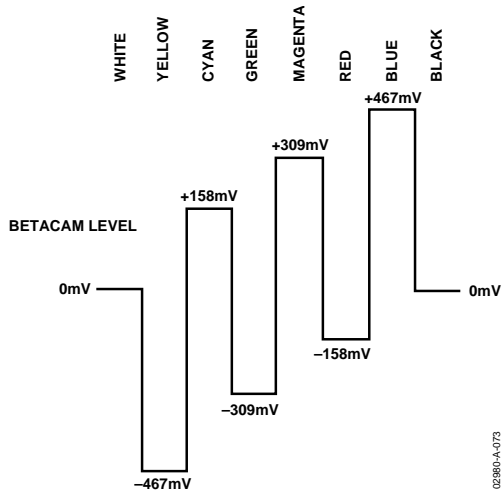

Figure 74. NTSC 100% Color Bars with Pedestal Pb Levels

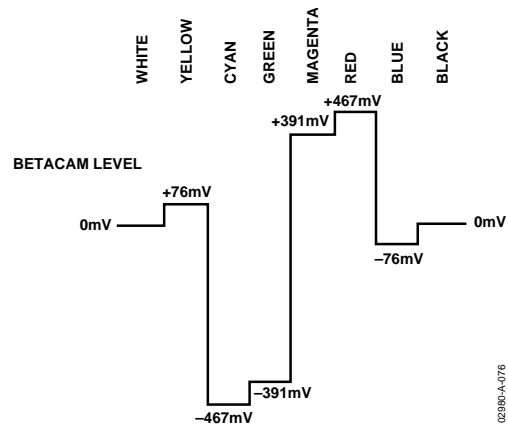

Figure 77. NTSC 100% Color Bars with Pedestal Pr Levels

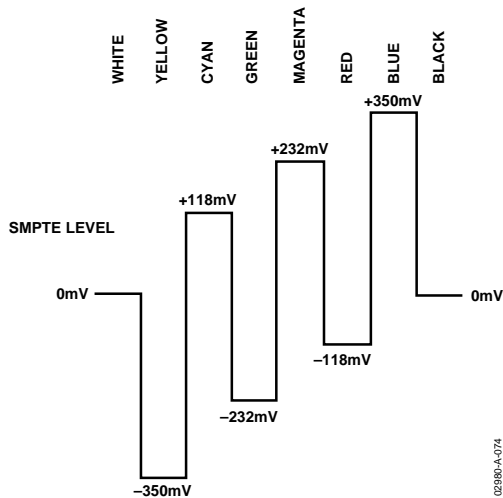

Figure 75. PAL 100% Color Bars, Pb Levels

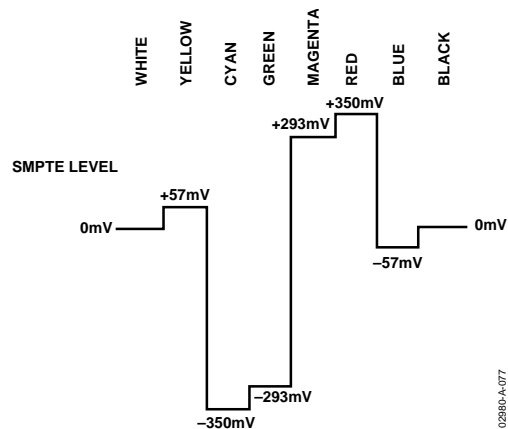

Figure 78. PAL 100% Color Bars, Pr Levels

APPENDIX 7—OPTIONAL OUTPUT FILTER

If an output filter is required for the CVBS, Y, UV, chroma, and RGB outputs of the ADV7174/ADV7179, the filter shown in Figure 79 can be used. Plots of the filter characteristics are shown in Figure 80. An output filter is not required if the outputs of the ADV7174/ADV7179 are connected to most analog monitors or analog TVs. However, if the output signals are applied to a system where sampling is used (e.g., digital TVs), then a filter is required to prevent aliasing.

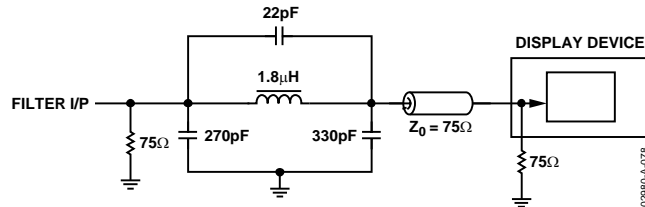

Figure 79. Output Filter

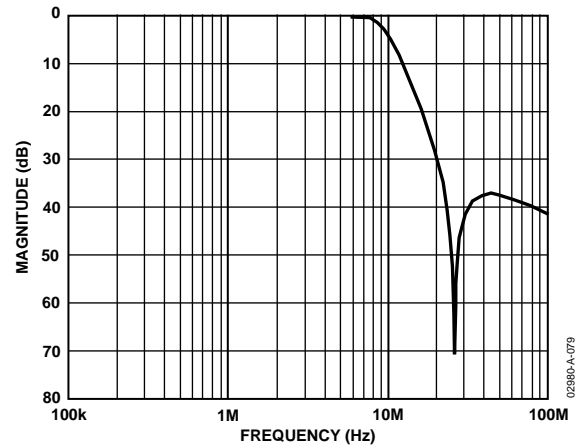

Figure 80. Output Filter Plot

APPENDIX 8—RECOMMENDED REGISTER VALUES

The ADV7174/ADV7179 registers can be set depending on the user standard required. The power-on reset values can be found in Figure 37.

The following examples give the various register formats for several video standards. In each case, the output is set to composite output with all DACs powered up and with the input control disabled. Additionally, the burst and BLANK color information is enabled on the output, and the internal color bar generator is

switched off. In the examples shown, the timing mode is set to Mode 0 in slave format. TR02–TR00 of the Timing Register 0 control the timing modes. For a detailed explanation of each bit in the command registers, refer to the Register Programming section. TR07 should be toggled after setting up a new timing mode. Timing Register 1 provides additional control over the position and duration of the timing signals. In the examples, this register is programmed in default mode.

Table 24. PAL B/D/G/H/I (F_{sc} = 4.43361875 MHz)

Address	Description	Data
00H	Mode Register 0	05H
01H	Mode Register 1	10H
02H	Mode Register 2	00H
03H	Mode Register 3	00H
04H	Mode Register 4	00H
07H	Timing Register 0	00H
08H	Timing Register 1	00H
09H	Subcarrier Frequency Register 0	CBH
0AH	Subcarrier Frequency Register 1	8AH
0BH	Subcarrier Frequency Register 2	09H
0CH	Subcarrier Frequency Register 3	2AH
0DH	Subcarrier Phase Register	00H
0EH	Closed Captioning Ext Register 0	00H
0FH	Closed Captioning Ext Register 1	00H
10H	Closed Captioning Register 0	00H
11H	Closed Captioning Register 1	00H
12H	Pedestal Control Register 0	00H
13H	Pedestal Control Register 1	00H
14H	Pedestal Control Register 2	00H
15H	Pedestal Control Register 3	00H
16H	CGMS_WSS Register 0	00H
17H	CGMS_WSS Register 1	00H
18H	CGMS_WSS Register 2	00H
19H	Teletext Request Control Register	00H
0FH	Closed Captioning Ext Register 1	00H
10H	Closed Captioning Register 0	00H
11H	Closed Captioning Register 1	00H
12H	Pedestal Control Register 0	00H
13H	Pedestal Control Register 1	00H
14H	Pedestal Control Register 2	00H
15H	Pedestal Control Register 3	00H
16H	CGMS_WSS Register 0	00H
17H	CGMS_WSS Register 1	00H
18H	CGMS_WSS Register 2	00H
19H	Teletext Request Control Register	00H

Table 25. PAL N (F_{sc} = 4.43361875 MHz)

Address	Description	Data
00H	Mode Register 0	05H
01H	Mode Register 1	10H
02H	Mode Register 2	00H
03H	Mode Register 3	00H
04H	Mode Register 4	00H
07H	Timing Register 0	00H
08H	Timing Register 1	00H
09H	Subcarrier Frequency Register 0	CBH
0AH	Subcarrier Frequency Register 1	8AH
0BH	Subcarrier Frequency Register 2	09H
0CH	Subcarrier Frequency Register 3	2AH
0DH	Subcarrier Phase Register	00H
0EH	Closed Captioning Ext Register 0	00H
0FH	Closed Captioning Ext Register 1	00H
10H	Closed Captioning Register 0	00H
11H	Closed Captioning Register 1	00H
12H	Pedestal Control Register 0	00H
13H	Pedestal Control Register 1	00H
14H	Pedestal Control Register 2	00H
15H	Pedestal Control Register 3	00H
16H	CGMS_WSS Register 0	00H
17H	CGMS_WSS Register 1	00H
18H	CGMS_WSS Register 2	00H
19H	Teletext Request Control Register	00H

Table 26. PAL-60 (F_{sc} = 4.43361875 MHz)

Address	Description	Data
00H	Mode Register 0	04H
01H	Mode Register 1	10H
02H	Mode Register 2	00H
03H	Mode Register 3	00H
04H	Mode Register 4	00H
07H	Timing Register 0	00H
08H	Timing Register 1	00H
09H	Subcarrier Frequency Register 0	CBH
0AH	Subcarrier Frequency Register 1	8AH
0BH	Subcarrier Frequency Register 2	09H
0CH	Subcarrier Frequency Register 3	2AH
0DH	Subcarrier Phase Register	00H
0EH	Closed Captioning Ext Register 0	00H
0FH	Closed Captioning Ext Register 1	00H
10H	Closed Captioning Register 0	00H
11H	Closed Captioning Register 1	00H
12H	Pedestal Control Register 0	00H
13H	Pedestal Control Register 1	00H
14H	Pedestal Control Register 2	00H
15H	Pedestal Control Register 3	00H
16H	CGMS_WSS Register 0	00H
17H	CGMS_WSS Register 1	00H
18H	CGMS_WSS Register 2	00H
19H	Teletext Request Control Register	00H

Table 27. NTSC (F_{sc} = 3.5795454 MHz)

Address	Description	Data
00H	Mode Register 0	00H
01H	Mode Register 1	10H
02H	Mode Register 2	00H
03H	Mode Register 3	00H
04H	Mode Register 4	10H
07H	Timing Register 0	00H
08H	Timing Register 1	00H
09H	Subcarrier Frequency Register 0	1EH ¹
0AH	Subcarrier Frequency Register 1	7CH
0BH	Subcarrier Frequency Register 2	F0H
0CH	Subcarrier Frequency Register 3	21H
0DH	Subcarrier Phase Register	00H
0EH	Closed Captioning Ext Register 0	00H
0FH	Closed Captioning Ext Register 1	00H
10H	Closed Captioning Register 0	00H
11H	Closed Captioning Register 1	00H
12H	Pedestal Control Register 0	00H
13H	Pedestal Control Register 1	00H
14H	Pedestal Control Register 2	00H
15H	Pedestal Control Register 3	00H
16H	CGMS_WSS Register 0	00H
17H	CGMS_WSS Register 1	00H
18H	CGMS_WSS Register 2	00H
19H	Teletext Request Control Register	00H

¹ On power-up, this register is set to 16h. 1Eh should be written here for correct F_{sc}.

OUTLINE DIMENSIONS

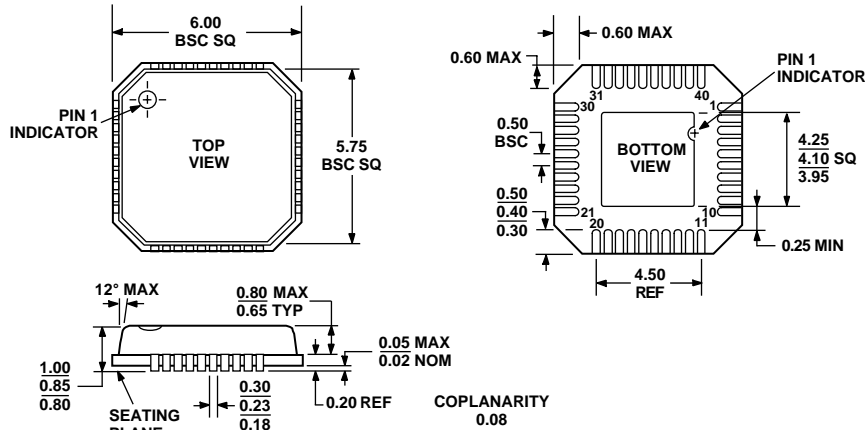

COMPLIANT TO JEDEC STANDARDS MO-220-VJJD-2

Figure 81. 40-Lead Lead Frame Chip Scale Package [LFCSP] (CP-40)
Dimensions shown in millimeters

Note that the exposed metal paddle on the bottom side of the LFCSP package must be soldered to PCB ground for proper heat dissipation and also for noise and mechanical strength benefits.

ORDERING GUIDE

Model	Temperature Range	Package Description	Package Option
ADV7179KCP	0°C to 70°C	Lead Frame Chip Scale Package	CP-40
ADV7179KCP-REEL	0°C to 70°C	Lead Frame Chip Scale Package	CP-40
ADV7179BCP	-40°C to +85°C	Lead Frame Chip Scale Package	CP-40
ADV7179BCP-REEL	-40°C to +85°C	Lead Frame Chip Scale Package	CP-40
ADV7174KCP	0°C to 70°C	Lead Frame Chip Scale Package	CP-40
ADV7174KCP-REEL	0°C to 70°C	Lead Frame Chip Scale Package	CP-40
ADV7174BCP	-40°C to +85°C	Lead Frame Chip Scale Package	CP-40
ADV7174BCP-REEL	-40°C to +85°C	Lead Frame Chip Scale Package	CP-40
EVAL-ADV7179EBM		Evaluation Board	
EVAL-ADV7174EBM		Evaluation Board	

Purchase of licensed I²C components of Analog Devices or one of its sublicensed Associated Companies conveys a license for the purchaser under the Philips I²C Patent Rights to use these components in an I²C system, provided that the system conforms to the I²C Standard Specification as defined by Philips.