



# TDA9885; TDA9886

## I<sup>2</sup>C-bus controlled single and multistandard alignment-free IF-PLL demodulators

Rev. 03 — 16 December 2008

Product data sheet

## 1. General description

The TDA9885 is an alignment-free multistandard (PAL and NTSC) vision and sound IF signal Phase-Locked Loop (PLL) demodulator for negative modulation only and FM processing.

The TDA9886 is an alignment-free multistandard (PAL, SECAM and NTSC) vision and sound IF signal PLL demodulator for positive and negative modulation, including sound AM and FM processing.

## 2. Features

- 5 V supply voltage
- Gain controlled wideband Vision Intermediate Frequency (VIF) amplifier, AC-coupled
- Multistandard true synchronous demodulation with active carrier regeneration: very linear demodulation, good intermodulation figures, reduced harmonics, and excellent pulse response
- Gated phase detector for L and L-accent standard
- Fully integrated VIF Voltage-Controlled Oscillator (VCO), alignment-free, frequencies switchable for all negative and positive modulated standards via I<sup>2</sup>C-bus
- Digital acquisition help, VIF frequencies of 33.4 MHz, 33.9 MHz, 38.0 MHz, 38.9 MHz, 45.75 MHz and 58.75 MHz
- 4 MHz reference frequency input: signal from PLL tuning system or operating as crystal oscillator
- VIF Automatic Gain Control (AGC) detector for gain control, operating as peak sync detector for negative modulated signals and as a peak white detector for positive modulated signals
- Precise fully digital Automatic Frequency Control (AFC) detector with 4-bit digital-to-analog converter, AFC bits readable via I<sup>2</sup>C-bus
- TakeOver Point (TOP) adjustable via I<sup>2</sup>C-bus or alternatively with potentiometer
- Fully integrated sound carrier trap for 4.5 MHz, 5.5 MHz, 6.0 MHz and 6.5 MHz, controlled by FM-PLL oscillator
- Sound IF (SIF) input for single reference Quasi Split Sound (QSS) mode, PLL controlled
- SIF AGC for gain controlled SIF amplifier, single reference QSS mixer able to operate in high performance single reference QSS mode and in intercarrier mode, switchable via I<sup>2</sup>C-bus
- AM demodulator without extra reference circuit
- Alignment-free selective FM-PLL demodulator with high linearity and low noise



- Four selectable I<sup>2</sup>C-bus addresses
- I<sup>2</sup>C-bus control for all functions
- I<sup>2</sup>C-bus transceiver with pin programmable Module Address (MAD)

### 3. Applications

- TV, VTR, PC, and STB applications

### 4. Quick reference data

Table 1. Quick reference data

Symbol	Parameter	Conditions	Min	Typ	Max	Unit
V <sub>P</sub>	supply voltage		[1] 4.5	5.0	5.5	V
I <sub>P</sub>	supply current		52	63	70	mA
τ <sub>P</sub>	time constant (R × C) for network at pin V <sub>P</sub>	for applications without I <sup>2</sup> C-bus	1.2	-	-	μs
<b>Video part</b>						
V <sub>i(VIF)(rms)</sub>	VIF input voltage sensitivity (RMS value)	-1 dB video at output	-	60	100	μV
G <sub>VIF(cr)</sub>	control range VIF gain	see <a href="#">Figure 9</a>	60	66	-	dB
f <sub>VIF</sub>	vision carrier operating frequencies	see <a href="#">Table 13</a>	-	33.4	-	MHz
			-	33.9	-	MHz
			-	38.0	-	MHz
			-	38.9	-	MHz
			-	45.75	-	MHz
			-	58.75	-	MHz
Δf <sub>VIF</sub>	VIF frequency window of digital acquisition help	related to f <sub>VIF</sub> ; see <a href="#">Figure 12</a>	-	±2.3	-	MHz
V <sub>o(v)(p-p)</sub>	video output voltage (peak-to-peak value)	see <a href="#">Figure 7</a>				
		normal mode (sound carrier trap active) and sound carrier on	1.7	2.0	2.3	V
		trap bypass mode and sound carrier off	[2] 0.95	1.10	1.25	V
G <sub>dif</sub>	differential gain	"ITU-T J.63 line 330"	[3]			
		B/G standard	-	-	5	%
		L standard	-	-	7	%
φ <sub>dif</sub>	differential phase	"ITU-T J.63 line 330"	-	2	4	deg
B <sub>V(-1dB)</sub>	-1 dB video bandwidth	trap bypass mode and sound carrier off; AC load: C <sub>L</sub> < 20 pF, R <sub>L</sub> > 1 kΩ	[2] 5	6	-	MHz
B <sub>V(-3dB)(trap)</sub>	-3 dB video bandwidth including sound carrier trap	f <sub>trap</sub> = 4.5 MHz	[4] 3.95	4.05	-	MHz
		f <sub>trap</sub> = 5.5 MHz	[4] 4.90	5.00	-	MHz
		f <sub>trap</sub> = 6.0 MHz	[4] 5.40	5.50	-	MHz
		f <sub>trap</sub> = 6.5 MHz	[4] 5.50	5.95	-	MHz
α <sub>SC1</sub>	attenuation at first sound carrier	f = 4.5 MHz	30	36	-	dB
		f = 5.5 MHz	30	36	-	dB

Table 1. Quick reference data ...continued

Symbol	Parameter	Conditions	Min	Typ	Max	Unit
S/N <sub>W</sub>	weighted signal-to-noise ratio	unified weighting filter ("ITU-T J.61"); see <a href="#">Figure 13</a>	[5] 56	59	-	dB
PSRR <sub>CVBS</sub>	power supply ripple rejection on pin CVBS	f <sub>ripple</sub> = 70 Hz; video signal; grey level; positive and negative modulation; see <a href="#">Figure 8</a>	20	25	-	dB
AFC <sub>stps</sub>	AFC control steepness	definition: ΔI <sub>AFC</sub> / Δf <sub>VIF</sub>	0.85	1.05	1.25	μA/kHz
<b>Audio part</b>						
V <sub>o(AF)(rms)</sub>	AF output voltage (RMS value)	27 kHz FM deviation; 50 μs de-emphasis	430	540	650	mV
THD	total harmonic distortion	25 kHz FM deviation; 50 μs de-emphasis	-	0.15	0.50	%
		54 % AM modulation	-	0.5	1.0	%
B <sub>AF(-3dB)</sub>	-3 dB AF bandwidth	without de-emphasis; measured with FM-PLL filter of <a href="#">Figure 26</a>	80	100	-	kHz
S/N <sub>W(AF)</sub>	weighted signal-to-noise ratio of audio signal	black picture; see <a href="#">Figure 21</a>	50	56	-	dB
		in accordance with "ITU-R BS.468-4"	45	50	-	dB
α <sub>AM(sup)</sub>	AM suppression of FM demodulator	referenced to 27 kHz FM deviation; 50 μs de-emphasis; AM: f = 1 kHz; m = 54 %	40	46	-	dB
PSRR <sub>AM</sub>	power supply ripple rejection	see <a href="#">Figure 8</a>	20	26	-	dB
PSRR <sub>FM</sub>	power supply ripple rejection	f <sub>ripple</sub> = 70 Hz; see <a href="#">Figure 8</a>	14	20	-	dB
V <sub>o(intc)(rms)</sub>	IF intercarrier output level (RMS value)	QSS mode; SC <sub>1</sub> ; SC <sub>2</sub> off	90	140	180	mV
		L standard; without modulation	90	140	180	mV
		intercarrier mode; PC / SC <sub>1</sub> = 20 dB; SC <sub>2</sub> off	[6] -	75	-	mV
<b>Reference frequency input; pin REF</b>						
f <sub>ref</sub>	reference signal frequency		[7] -	4	-	MHz
V <sub>ref(rms)</sub>	reference signal voltage (RMS value)	operation as input terminal	80	-	400	mV

[1] Values of video and sound parameters can be decreased at V<sub>P</sub> = 4.5 V.

[2] The sound carrier trap can be bypassed by switching the I<sup>2</sup>C-bus. In this way the full composite video spectrum appears at pin CVBS. The amplitude is 1.1 V (p-p).

[3] Condition: luminance range (5 steps) from 0 % to 100 %.

[4] AC load; C<sub>L</sub> < 20 pF and R<sub>L</sub> > 1 kΩ. The sound carrier frequencies (depending on TV standard) are attenuated by the integrated sound carrier traps (see [Figure 15](#) to [Figure 20](#); |H(s)| is the absolute value of transfer function).

[5] S/N is the ratio of black-to-white amplitude to the noise voltage (RMS value measured on pin CVBS and tested at video black level, 'quiet line'). Noise analyzer settings: B = 5 MHz, 200 kHz high-pass and sound carrier trap on. In case of S/N<sub>W</sub> weighted in accordance with "ITU-T J.61". Measurements taken for B/G standard.

[6] The intercarrier output signal at pin SIOMAD can be calculated by the following formula taking into account the internal video signal with

$$1.1 \text{ V (p-p) as a reference: } V_{o(intc)(rms)} = 1.1 \times \frac{1}{2\sqrt{2}} \times 10^r \text{ V and } r = \frac{1}{20} \times \left( \frac{V_{i(SC)}}{V_{i(PC)}} \text{ (dB)} + 6 \text{ dB} \pm 3 \text{ dB} \right), \text{ where: } \frac{1}{2\sqrt{2}}$$

is the correction term for RMS value,  $\frac{V_{i(SC)}}{V_{i(PC)}} \text{ (dB)}$  is the sound-to-picture carrier ratio at pins VIF1 and VIF2 in dB, 6 dB is the correction term of internal circuitry and ±3 dB is the tolerance of video output and intercarrier output V<sub>o(intc)(rms)</sub>.

[7] Pin REF is able to operate as a 1-pin crystal oscillator input as well as an external reference signal input, e.g. from the tuning system.

## 5. Ordering information

Table 2. Ordering information

Type number	Package		Version
	Name	Description	
TDA9885T/V3	SO24	plastic small outline package; 24 leads; body width 7.5 mm	SOT137-1
TDA9885TS/V3	SSOP24	plastic shrink small outline package; 24 leads; body width 5.3 mm	SOT340-1
TDA9885HN/V3	HVQFN32	plastic thermal enhanced very thin quad flat package; no leads; 32 terminals; body 5 × 5 × 0.85 mm	SOT617-3
TDA9886T/V4	SO24	plastic small outline package; 24 leads; body width 7.5 mm	SOT137-1
TDA9886TS/V4	SSOP24	plastic shrink small outline package; 24 leads; body width 5.3 mm	SOT340-1
TDA9886HN/V4	HVQFN32	plastic thermal enhanced very thin quad flat package; no leads; 32 terminals; body 5 × 5 × 0.85 mm	SOT617-3
TDA9885T/V5	SO24	plastic small outline package; 24 leads; body width 7.5 mm	SOT137-1
TDA9885TS/V5	SSOP24	plastic shrink small outline package; 24 leads; body width 5.3 mm	SOT340-1
TDA9885HN/V5	HVQFN32	plastic thermal enhanced very thin quad flat package; no leads; 32 terminals; body 5 × 5 × 0.85 mm	SOT617-3
TDA9886T/V5	SO24	plastic small outline package; 24 leads; body width 7.5 mm	SOT137-1
TDA9886TS/V5	SSOP24	plastic shrink small outline package; 24 leads; body width 5.3 mm	SOT340-1
TDA9886HN/V5	HVQFN32	plastic thermal enhanced very thin quad flat package; no leads; 32 terminals; body 5 × 5 × 0.85 mm	SOT617-3

6. Block diagram

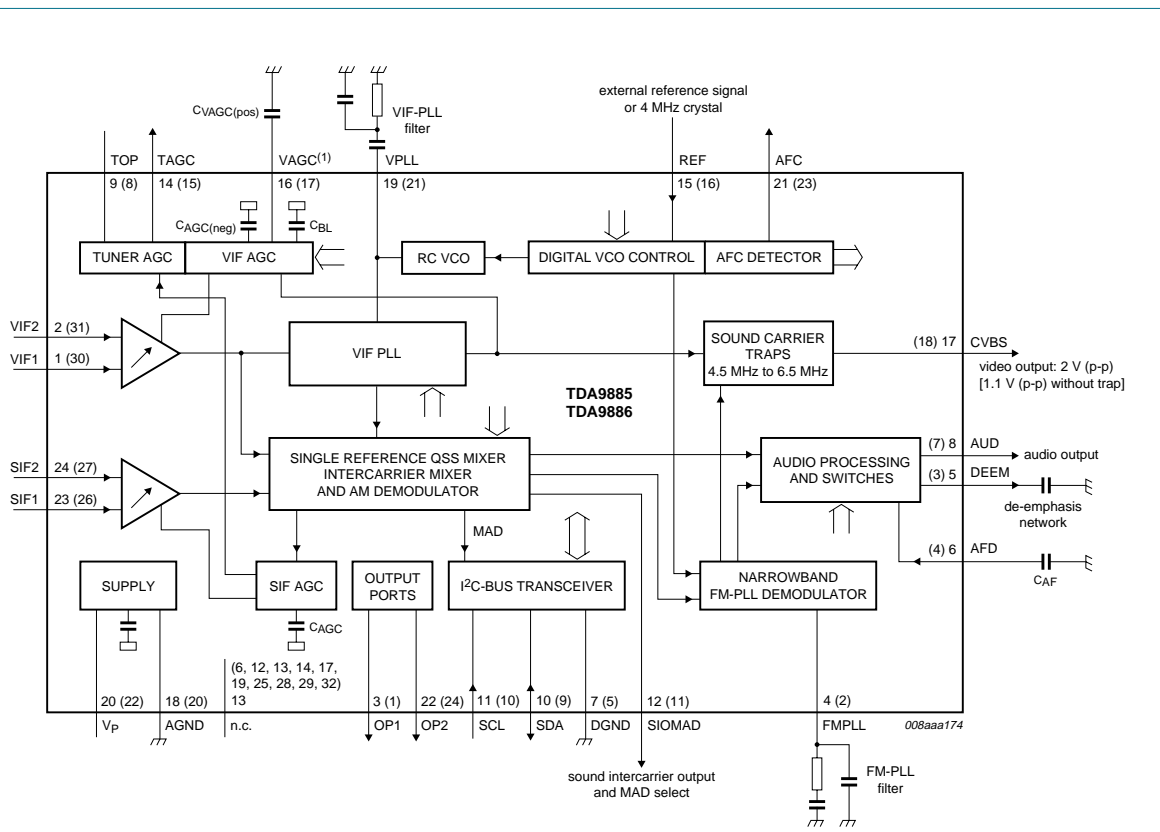

Pin numbers for TDA9885HN and TDA9886HN in parentheses.

(1) Not connected for TDA9885

Fig 1. Block diagram of TDA9885; TDA9886

## 7. Pinning information

### 7.1 Pinning

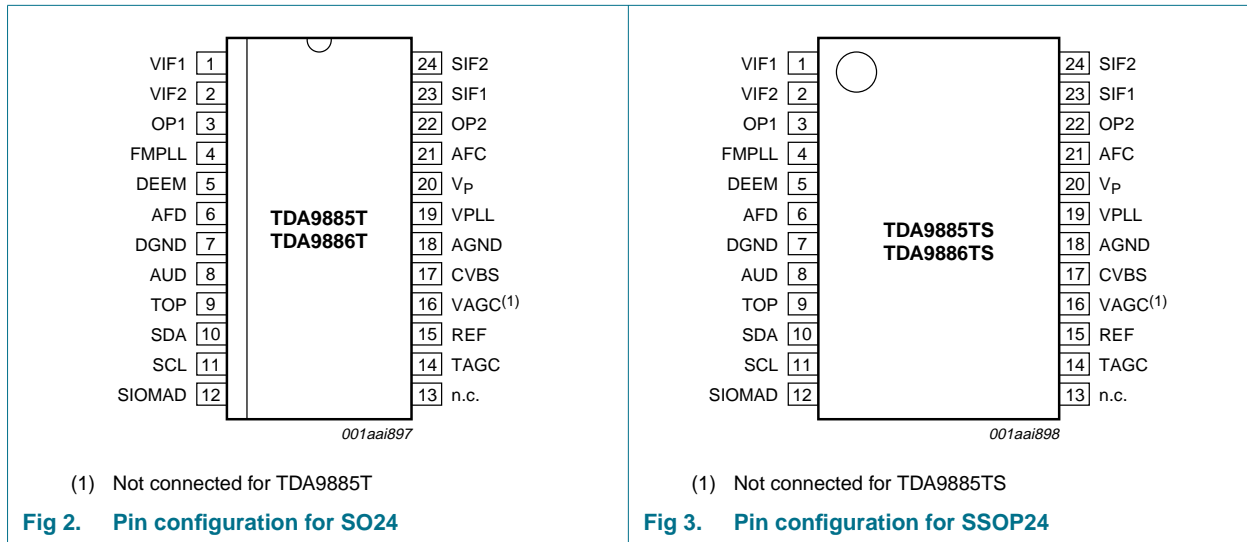

**Fig 3. Pin configuration for SSOP24**

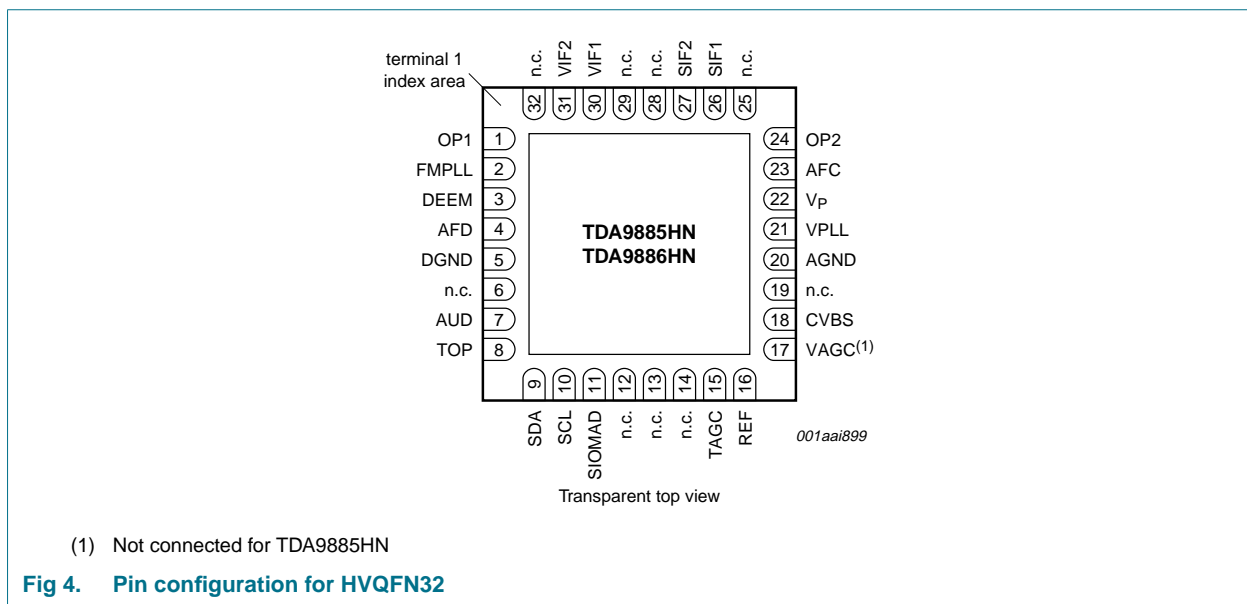

## 7.2 Pin description

Table 3. Pin description

Symbol	Pin				Description
	TDA9885T TDA9885TS	TDA9886T TDA9886TS	TDA9885HN	TDA9886HN	
VIF1	1	1	30	30	VIF differential input 1
VIF2	2	2	31	31	VIF differential input 2
n.c.	-	-	32	32	not connected
OP1	3	3	1	1	output port 1; open-collector
FMPLL	4	4	2	2	FM PLL for loop filter
DEEM	5	5	3	3	de-emphasis output for capacitor
AFD	6	6	4	4	AF DC-decoupling capacitor
DGND	7	7	5	5	digital ground
n.c.	-	-	6	6	not connected
AUD	8	8	7	7	audio output
TOP	9	9	8	8	tuner AGC TOP for resistor adjustment
SDA	10	10	9	9	I <sup>2</sup> C-bus data input and output
SCL	11	11	10	10	I <sup>2</sup> C-bus clock input
SIOMAD	12	12	11	11	sound intercarrier output and MAD select with resistor
n.c.	-	-	12	12	not connected
n.c.	13	13	13	13	not connected
n.c.	-	-	14	14	not connected
TAGC	14	14	15	15	tuner AGC output
REF	15	15	16	16	4 MHz crystal or reference signal input
VAGC	-	16	-	17	VIF AGC for capacitor
n.c.	16	-	17	-	not connected
CVBS	17	17	18	18	composite video output
n.c.	-	-	19	19	not connected
AGND	18	18	20	20	analog ground
VPLL	19	19	21	21	VIF PLL for loop filter
V <sub>P</sub>	20	20	22	22	supply voltage
AFC	21	21	23	23	AFC output
OP2	22	22	24	24	output port 2; open-collector
n.c.	-	-	25	25	not connected
SIF1	23	23	26	26	SIF differential input 1 and MAD select with resistor
SIF2	24	24	27	27	SIF differential input 2 and MAD select with resistor
n.c.	-	-	28	28	not connected
n.c.	-	-	29	29	not connected

## 8. Functional description

[Figure 1](#) shows the simplified block diagram of the device which comprises the following functional blocks:

- VIF amplifier
- Tuner AGC and VIF AGC
- VIF-AGC detector
- Frequency Phase-Locked Loop (FPLL) detector
- VCO and divider
- AFC and digital acquisition help
- Video demodulator and amplifier
- Sound carrier trap
- SIF amplifier
- SIF-AGC detector
- Single reference QSS mixer
- AM demodulator
- FM demodulator and acquisition help
- Audio amplifier and mute time constant
- Internal voltage stabilizer
- I<sup>2</sup>C-bus transceiver and MAD

### 8.1 VIF amplifier

The VIF amplifier consists of three AC-coupled differential stages. Gain control is performed by emitter degeneration and collector resistor variation. The total gain control range is typically 66 dB. The differential input impedance is typically 2 k $\Omega$  in parallel with 3 pF.

### 8.2 Tuner AGC and VIF AGC

This block adapts the voltage, generated at the VIF-AGC detector, to the internal signal processing at the VIF amplifier and performs the tuner AGC control current generation. The onset of the tuner AGC control current generation can be set either via the I<sup>2</sup>C-bus (see [Table 12](#)) or optionally by a potentiometer at pin TOP (in case that the I<sup>2</sup>C-bus information cannot be stored, related to the device). The presence of a potentiometer is automatically detected and the I<sup>2</sup>C-bus setting is disabled.

Furthermore, derived from the AGC detector voltage, a comparator is used to detect if the corresponding VIF input voltage is higher than 200  $\mu$ V. This information can be read out via the I<sup>2</sup>C-bus (bit VIFLEV = 1).



### 8.3 VIF-AGC detector

Gain control is performed by sync level detection (negative modulation) or peak white detection (positive modulation).

For negative modulation, the sync level voltage is stored at an integrated capacitor by means of a fast peak detector. This voltage is compared with a reference voltage (nominal sync level) by a comparator which charges or discharges the integrated AGC capacitor for providing of the required VIF gain. The time constants for decreasing or increasing the gain are nearly equal and the total AGC reaction time is fast to cope with 'aeroplane fluttering'.

For positive modulation, the white peak level voltage is compared with a reference voltage (nominal white level) by a comparator which charges (fast) or discharges (slow) the external AGC capacitor directly for providing the required VIF gain. The need of a very long time constant for VIF gain increase is due to peak white level may appear only once in a field. In order to reduce this time constant, an additional level detector increases the discharging current of the AGC capacitor (fast mode) in the event of a decreasing VIF amplitude step controlled by the detected actual black level voltage. The threshold level for fast mode AGC is typically -6 dB video amplitude. The fast mode state is also transferred to the SIF-AGC detector for speed-up. In case of missing peak white pulses, the VIF gain increase is limited to typically +3 dB by comparing the detected actual black level voltage with a corresponding reference voltage.

### 8.4 FPLL detector

The VIF amplifier output signal is fed into a frequency detector and into a phase detector via a limiting amplifier for removing the video AM.

During acquisition the frequency detector produces a current proportional to the frequency difference between the VIF and the VCO signals. After frequency lock-in the phase detector produces a current proportional to the phase difference between the VIF and the VCO signals. The currents from the frequency and phase detectors are charged into the loop filter which controls the VIF VCO and locks it to the frequency and phase of the VIF carrier.

For a positive modulated VIF signal, the charging currents are optional gated by the composite sync in order to avoid signal distortion in case of overmodulation. The gating depth is switchable via the I<sup>2</sup>C-bus.

### 8.5 VCO and divider

The VCO of the VIF FPLL operates as an integrated low radiation relaxation oscillator at double the picture carrier frequency. The control voltage, required to tune the VCO to double the picture carrier frequency, is generated at the loop filter by the frequency phase detector. The possible frequency range is 50 MHz to 140 MHz (typical value).

The oscillator frequency is divided-by-two to provide two differential square wave signals with exactly 90 degrees phase difference, independent of the frequency, for use in the FPLL detectors, the video demodulator and the intercarrier mixer.

## 8.6 AFC and digital acquisition help

Each relaxation oscillator of the VIF-PLL and FM-PLL demodulator has a wide frequency range. To prevent false locking of the PLLs and with respect to the catching range, the digital acquisition help provides an individual control, until the frequency of the VCO is within the preselected standard dependent lock-in window of the PLL.

The in-window and out-window control at the FM PLL is additionally used to mute the audio stage (if auto mute is selected via the I<sup>2</sup>C-bus).

The working principle of the digital acquisition help is as follows. The PLL VCO output is connected to a down counter which has a predefined start value (standard dependent). The VCO frequency clocks the down counter for a fixed gate time. Thereafter, the down counter stop value is analyzed. In case the stop value is higher (lower) than the expected value range, the VCO frequency is lower (higher) than the wanted lock-in window frequency range. A positive (negative) control current is injected into the PLL loop filter and consequently the VCO frequency is increased (decreased) and a new counting cycle starts.

The gate time as well as the control logic of the acquisition help circuit is dependent on the precision of the reference signal at pin REF. Operation as a crystal oscillator is possible as well as connecting this input via a serial capacitor to an external reference frequency, e.g. the tuning system oscillator.

The AFC signal is derived from the corresponding down counter stop value after a counting cycle. The last four bits are latched and can be read out via the I<sup>2</sup>C-bus (see [Table 8](#)). Also the digital-to-analog converted value is given as current at pin AFC.

## 8.7 Video demodulator and amplifier

The video demodulator is realized by a multiplier which is designed for low distortion and large bandwidth. The VIF signal is multiplied with the 'in phase' signal of the VIF-PLL VCO.

The demodulator output signal is fed into the video preamplifier via a level shift stage with integrated low-pass filter to achieve carrier harmonics attenuation.

The output signal of the preamplifier is fed to the VIF-AGC detector (see [Section 8.3](#)) and in the sound trap mode also fed internally to the integrated sound carrier trap (see [Section 8.8](#)). The differential trap output signal is converted to a single-ended signal and amplified by the following post-amplifier. The video output level at pin CVBS is 2 V (p-p).

In the trap bypass mode the output signal of the preamplifier is fed directly through the post-amplifier to pin CVBS. The output video level is 1.1 V (p-p) for using an external sound trap with 10 % overall loss.

Noise clipping is provided in both cases.

## 8.8 Sound carrier trap

The sound trap is constructed of three separate traps to realize sufficient suppression of the first and second sound carriers.

For frequency control of the sound trap additionally a reference low-pass filter and a phase detector are built in.

A sound carrier reference signal is fed into the reference low-pass filter and is shifted by nominal 90 degrees. The phase detector compares the original reference signal with the signal shifted by the reference filter and produces a DC voltage by charging or discharging an integrated capacitor with a current proportional to the phase difference between both signals, respectively to the frequency error of the integrated filters. The DC voltage controls the frequency position of the reference filter and the sound trap. So the accurate frequency position for the different standards is set by the sound carrier reference signal.

## 8.9 SIF amplifier

The SIF amplifier consists of three AC-coupled differential stages. Gain control is performed by emitter degeneration and collector resistor variation. The total gain control range is typically 66 dB. The differential input impedance is typically 2 k $\Omega$  in parallel with 3 pF.

## 8.10 SIF-AGC detector

SIF gain control is performed by detection and controlling to a reference value of the DC component of the AM demodulator output signal. This DC signal corresponds directly to the SIF voltage at the output of the SIF amplifier so that a constant SIF signal is supplied to the AM demodulator and to the single reference QSS mixer.

By switching the gain of the input amplifier of the SIF-AGC detector via the I<sup>2</sup>C-bus, the internal SIF level for FM sound is 5.5 dB lower than for AM sound. This is to adapt the SIF-AGC characteristic to the VIF-AGC characteristic. The adaption is ideal for a picture-to-sound FM carrier ratio of 13 dB.

Via a comparator, the integrated AGC capacitor is charged or discharged for providing the required SIF gain. Due to AM sound, the AGC reaction time is slow ( $f_c < 20$  Hz for the closed AGC loop). For reducing this AM sound time constant in the event of a decreasing IF amplitude step, the charge/discharge current of the AGC capacitor is increased (fast mode) when the VIF-AGC detector (at positive modulation mode) operates in the fast mode too. An additional circuit (threshold approximately 7 dB) ensures a very fast gain reduction for a large increasing IF amplitude step.

## 8.11 Single reference QSS mixer

With the present system a high performance Hi-Fi stereo sound processing can be achieved. For a simplified application without a SIF SAW filter, the single reference QSS mixer can be switched to the intercarrier mode via the I<sup>2</sup>C-bus.

The single reference QSS mixer generates the 2nd FM TV sound intercarrier signal. It is realized by a linear multiplier which multiplies the SIF amplifier output signal and the VIF-PLL VCO signal (90 degrees output) which is locked to the picture carrier. In this way the QSS mixer operates as a quadrature mixer in the intercarrier mode and provides suppression of the low frequency video signals.

The QSS mixer output signal is fed internally via a high-pass and low-pass combination to the FM demodulator as well as via an operational amplifier to the intercarrier output pin SIOMAD.

### 8.12 AM demodulator

The amplitude modulated SIF amplifier output signal is fed both to a two-stage limiting amplifier that removes the AM and to a linear multiplier. The result of the multiplication of the SIF signal with the limiter output signal is AM demodulation (passive synchronous demodulator). The demodulator output signal is fed via a low-pass filter that attenuates the carrier harmonics and through the input amplifier of the SIF-AGC detector to the audio amplifier.

### 8.13 FM demodulator and acquisition help

The narrowband FM-PLL detector consists of:

- Gain controlled FM amplifier and AGC detector
- Narrowband PLL

The 2nd SIF signal from the intercarrier mixer is fed to the input of an AC-coupled gain controlled amplifier with two stages. The gain controlled output signal is fed to the phase detector of the narrowband FM PLL (FM demodulator). For good selectivity and robustness against disturbance caused by the video signal, a high linearity of the gain controlled FM amplifier and of the phase detector as well as a constant signal level are required. The gain control is done by means of an 'in phase' demodulator for the 2nd SIF signal (from the output of the FM amplifier). The demodulation output is fed into a comparator for charging or discharging the integrated AGC capacitor. This leads to a mean value AGC loop to control the gain of the FM amplifier.

The FM demodulator is realized as a narrowband PLL with an external loop filter, which provides the necessary selectivity (bandwidth approximately 100 kHz). To achieve good selectivity, a linear phase detector and a constant input level are required. The gain controlled intercarrier signal from the FM amplifier is fed to the phase detector. The phase detector controls via the loop filter the integrated low radiation relaxation oscillator. The designed frequency range is from 4 MHz to 7 MHz.

The VCO within the FM PLL is phase-locked to the incoming 2nd SIF signal, which is frequency modulated. As well as this, the VCO control voltage is superimposed by the AF voltage. Therefore, the VCO tracks with the FM of the 2nd SIF signal. So, the AF voltage is present at the loop filter and is typically 5 mV (RMS) for 27 kHz FM deviation. This AF signal is fed via a buffer to the audio amplifier.

The correct locking of the PLL is supported by the digital acquisition help circuit (see [Section 8.6](#)).

### 8.14 Audio amplifier and mute time constant

The audio amplifier consists of two parts:

- AF preamplifier
- AF output amplifier

The AF preamplifier used for FM sound is an operational amplifier with internal feedback, high gain and high common mode rejection. The AF voltage from the PLL demodulator is 5 mV (RMS) for a frequency deviation of 27 kHz and is amplified by 30 dB. By the use of a DC operating point control circuit (with external capacitor CAF), the AF preamplifier is decoupled from the PLL DC voltage. The low-pass characteristic of the amplifier reduces the harmonics of the 2nd SIF signal at the AF output terminal.

For FM sound a switchable de-emphasis network (with external capacitor) is implemented between the preamplifier and the output amplifier.

The AF output amplifier provides the required AF output level by a rail-to-rail output stage. A preceding stage makes use of an input selector for switching between FM sound, AM sound and mute state. The gain can be switched between 10 dB (normal) and 4 dB (reduced).

Switching to the mute state is controlled automatically, dependent on the digital acquisition help in case the VCO of the FM PLL is not in the required frequency window. This is done by a time constant: fast for switching to the mute state and slow (typically 40 ms) for switching to the no-mute state.

All switching functions are controlled via the I<sup>2</sup>C-bus:

- AM sound, FM sound and forced mute
- Auto mute enable or disable
- De-emphasis off or on with 50  $\mu$ s or 75  $\mu$ s
- Audio gain normal or reduced

### 8.15 Internal voltage stabilizer

The band gap circuit internally generates a voltage of approximately 2.4 V, independent of supply voltage and temperature. A voltage regulator circuit, connected to this voltage, produces a constant voltage of 3.55 V which is used as an internal reference voltage.

### 8.16 I<sup>2</sup>C-bus transceiver and MAD

The device can be controlled via the 2-wire I<sup>2</sup>C-bus by a microcontroller. Two wires carry serial data (SDA) and serial clock (SCL) information between the devices connected to the I<sup>2</sup>C-bus.

The device has an I<sup>2</sup>C-bus slave transceiver with auto-increment. The circuit operates up to clock frequencies of 400 kHz.

A slave address is sent from the master to the slave receiver. To avoid conflicts in a real application with other devices providing similar or complementing functions, there are four possible slave addresses available. These MADs can be selected by connecting resistors on pin SIOMAD and/or pins SIF1 and SIF2 (see [Figure 26](#)). Pin SIOMAD relates with bit A0 and pins SIF1 and SIF2 relate with bit A3. The slave addresses of this device are given in [Table 4](#).

The power-on preset value is dependent on the use of pin SIOMAD and can be chosen for 45.75 MHz NTSC as default (pin SIOMAD left open-circuit) or 58.75 MHz NTSC (resistor on pin SIOMAD). In this way the device can be used without the I<sup>2</sup>C-bus as an NTSC only device.

**Remark:** In case of using the device without the I<sup>2</sup>C-bus, then the rise time of the supply voltage after switching on power must be longer than 1.2  $\mu$ s.

**Table 4. Slave address detection**

Slave address	Selectable address bit		Resistor on pin	
	A3	A0	SIF1 and SIF2	SIOMAD
MAD1	0	1	no	no
MAD2	0	0	no	yes
MAD3	1	1	yes	no
MAD4	1	0	yes	yes

## 9. I<sup>2</sup>C-bus control

### 9.1 Read format

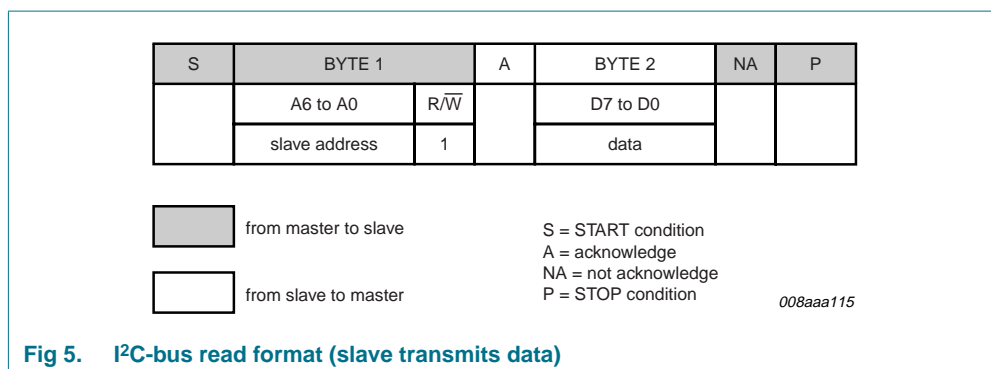

The master generates an acknowledge when it has received the data word READ. The master next generates an acknowledge, then slave begins transmitting the data word READ, and so on until the master generates an acknowledge-not bit and transmits a STOP condition.

#### 9.1.1 Slave address

The first module address MAD1 is the standard address (see [Table 4](#)).

**Table 5. Slave addresses**

For MAD activation via external resistor: see [Table 4](#) and [Figure 26](#).

For applications without I<sup>2</sup>C-bus: see [Table 16](#) and [Table 17](#).

Slave address		Bit						
Name	Value	A6	A5	A4	A3	A2	A1	A0
MAD1	43h	1	0	0	0	0	1	1
MAD2	42h	1	0	0	0	0	1	0
MAD3	4Bh	1	0	0	1	0	1	1
MAD4	4Ah	1	0	0	1	0	1	0

## 9.1.2 Data byte

Table 6. Data read register (status register)

MSB							LSB
D7	D6	D5	D4	D3	D2	D1	D0
AFCWIN	VIFLEV	CARRDET	AFC4	AFC3	AFC2	AFC1	PONR

Table 7. Description of status register bits

Bit	Symbol	Description
7	AFCWIN	AFC window 1 = VCO in $\pm 1.6$ MHz AFC window <sup>[1]</sup> 0 = VCO out of $\pm 1.6$ MHz AFC window
6	VIFLEV	VIF input level 1 = high level; VIF input voltage $\geq 200$ $\mu$ V (typically) 0 = low level
5	CARRDET	FM carrier detection 1 = detection 0 = no detection
4 to 1	AFC[4:1]	automatic frequency control; see <a href="#">Table 8</a>
0	PONR	power-on reset 1 = after power-on reset or after supply breakdown 0 = after a successful reading of the status register

[1] If no IF input is applied, then bit AFCWIN = 1 due to the fact that the VCO is forced to the AFC window border for fast lock-in behavior.

**Table 8. Automatic frequency control bits**

$f_0$  is the nominal frequency of  $f_{VIF}$ .

Bit				$f_{VIF}$
AFC4	AFC3	AFC2	AFC1	
0	1	1	1	$\leq (f_0 - 187.5 \text{ kHz})$
0	1	1	0	$f_0 - 162.5 \text{ kHz}$
0	1	0	1	$f_0 - 137.5 \text{ kHz}$
0	1	0	0	$f_0 - 112.5 \text{ kHz}$
0	0	1	1	$f_0 - 87.5 \text{ kHz}$
0	0	1	0	$f_0 - 62.5 \text{ kHz}$
0	0	0	1	$f_0 - 37.5 \text{ kHz}$
0	0	0	0	$f_0 - 12.5 \text{ kHz}$
1	1	1	1	$f_0 + 12.5 \text{ kHz}$
1	1	1	0	$f_0 + 37.5 \text{ kHz}$
1	1	0	1	$f_0 + 62.5 \text{ kHz}$
1	1	0	0	$f_0 + 87.5 \text{ kHz}$
1	0	1	1	$f_0 + 112.5 \text{ kHz}$
1	0	1	0	$f_0 + 137.5 \text{ kHz}$
1	0	0	1	$f_0 + 162.5 \text{ kHz}$
1	0	0	0	$\geq (f_0 + 187.5 \text{ kHz})$

## 9.2 Write format

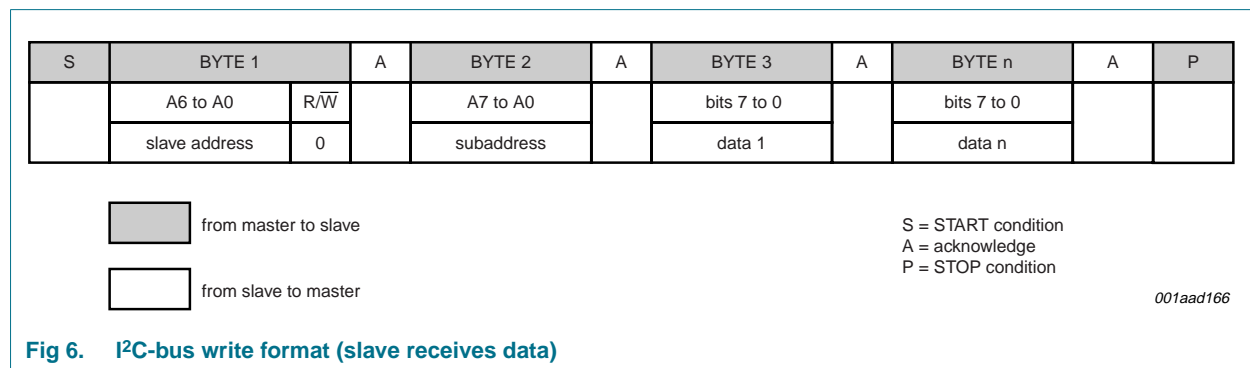



### 9.2.1 Subaddress (A data)

If more than one data byte is transmitted, then auto-increment is performed: starting from the transmitted subaddress and auto-increment of subaddress in accordance with the order of [Table 9](#).

**Table 9. Definition of the subaddress (second byte after slave address)**

*X = don't care.*

Register	MSB							LSB	
	A7 <sup>[1]</sup>	A6 <sup>[2]</sup>	A5 <sup>[2]</sup>	A4 <sup>[2]</sup>	A3 <sup>[2]</sup>	A2 <sup>[2]</sup>	A1	A0	
SAD for switching mode	0	X	X	X	X	X	0	0	
SAD for adjust mode	0	X	X	X	X	X	0	1	
SAD for data mode	0	X	X	X	X	X	1	0	

[1] Bit A7 = 1 is not allowed.

[2] Bits A6 to A2 will be ignored by the internal hardware.

### 9.2.2 Data byte for switching mode (B data)

**Table 10. Bit description of SAD register for switching mode (SAD = 00)**

Bit	Symbol	Description
7	B7	output port 2 for SAW switching or monitoring 1 = high-impedance, disabled or HIGH 0 = low-impedance, active or LOW
6	B6	output port 1 for SAW switching or external input 1 = high-impedance, disabled or HIGH 0 = low-impedance, active or LOW
5	B5	forced audio mute 1 = on 0 = off
4 and 3	B[4:3]	TV standard modulation 00 = positive AM TV <sup>[1]</sup> 01 = not used 10 = negative FM TV 11 = not used
2	B2	carrier mode 1 = QSS mode 0 = intercarrier mode
1	B1	auto mute of FM AF output 1 = active 0 = inactive
0	B0	video mode (sound trap) 1 = sound trap bypass 0 = sound trap active

[1] For positive AM TV choose 6.5 MHz for the second SIF.

### 9.2.3 Data byte for adjust mode (C data)

**Table 11. Bit description of SAD register for adjust mode (SAD = 01)**

Bit	Symbol	Description
7	C7	audio gain 1 = -6 dB 0 = 0 dB
6	C6	de-emphasis time constant 1 = 50 μs 0 = 75 μs
5	C5	de-emphasis 1 = on 0 = off
4 to 0	C[4:0]	tuner TOP adjustment; see <a href="#">Table 12</a>

**Table 12. Tuner takeover point adjustment bits**

Bit					TOP adjustment (dB)
C4	C3	C2	C1	C0	
1	1	1	1	1	+15
1	1	1	1	0	+14
1	1	1	0	1	+13
1	1	1	0	0	+12
1	1	0	1	1	+11
1	1	0	1	0	+10
1	1	0	0	1	+9
1	1	0	0	0	+8
1	0	1	1	1	+7
1	0	1	1	0	+6
1	0	1	0	1	+5
1	0	1	0	0	+4
1	0	0	1	1	+3
1	0	0	1	0	+2
1	0	0	0	1	+1
1	0	0	0	0	0 <sup>[1]</sup>
0	1	1	1	1	-1
0	1	1	1	0	-2
0	1	1	0	1	-3
0	1	1	0	0	-4
0	1	0	1	1	-5
0	1	0	1	0	-6
0	1	0	0	1	-7
0	1	0	0	0	-8
0	0	1	1	1	-9
0	0	1	1	0	-10

Table 12. Tuner takeover point adjustment bits ...continued

Bit					TOP adjustment (dB)
C4	C3	C2	C1	C0	
0	0	1	0	1	-11
0	0	1	0	0	-12
0	0	0	1	1	-13
0	0	0	1	0	-14
0	0	0	0	1	-15
0	0	0	0	0	-16

[1] For 0 dB refer to [Section 12](#) symbol  $QV_{TOP}$ .

### 9.2.4 Data byte for data mode (E data)

Table 13. Bit description of SAD register for data mode (SAD = 10)

Bit	Symbol	Description
7	E7	VIF AGC and port features; dependent on bit E5; see <a href="#">Table 14</a>
6	E6	L standard PLL gating 1 = gating in case of 36 % positive modulation 0 = gating in case of 0 % positive modulation
5	E5	VIF, SIF and tuner minimum gain; dependent on bit E7; see <a href="#">Table 14</a>
4 to 2	E[4:2]	vision intermediate frequency selection; see <a href="#">Table 15</a>
1 and 0	E[1:0]	sound intercarrier frequency selection (sound 2nd IF) 00 = $f_{FM} = 4.5$ MHz 01 = $f_{FM} = 5.5$ MHz 10 = $f_{FM} = 6.0$ MHz 11 = $f_{FM} = 6.5$ MHz <sup>[1]</sup>

[1] For positive modulation choose 6.5 MHz.

Table 14. Options in extended TV mode; bit B3 = 0 of SAD 00 register

Function	Bit E7 = 0		Bit E7 = 1	
	Bit E5 = 0	Bit E5 = 1	Bit E5 = 0	Bit E5 = 1
Pin OP1	port function	port function	port function	VIF-AGC external input <sup>[1]</sup>
Pin OP2	port function	port function	VIF-AGC output <sup>[1]</sup>	port function
Gain	normal gain	minimum gain	normal gain	external gain

[1] The corresponding port function has to be disabled (set to 'high-impedance'); see [Table 10](#) and [Table note 12](#) of [Table 20](#).

Table 15. TV standard selection for VIF

Video IF select bits			f <sub>VIF</sub> (MHz)
E4	E3	E2	
0	0	0	58.75 <sup>[1]</sup>
0	0	1	45.75 <sup>[1]</sup>
0	1	0	38.9
0	1	1	38.0
1	0	0	33.9
1	0	1	33.4
1	1	0	not applicable
1	1	1	not applicable

[1] Pin SIOMAD can be used for the selection of the different NTSC standards without I<sup>2</sup>C-bus. With a resistor on pin SIOMAD, f<sub>VIF</sub> = 58.75 MHz; without a resistor on pin SIOMAD, f<sub>VIF</sub> = 45.75 MHz (NTSC-M).

Table 16. Data setting after power-on reset (default setting with a resistor on pin SIOMAD)

Register	Byte							
	MSB							LSB
	7	6	5	4	3	2	1	0
Switching mode (B data)	1	1	0	1	0	1	1	0
Adjust mode (C data)	0	0	1	1	0	0	0	0
Data mode (E data)	0	0	0	0	0	0	0	0

Table 17. Data setting after power-on reset (default setting without a resistor on pin SIOMAD)

Register	Byte							
	MSB							LSB
	7	6	5	4	3	2	1	0
Switching mode (B data)	1	1	0	1	0	1	1	0
Adjust mode (C data)	0	0	1	1	0	0	0	0
Data mode (E data)	0	0	0	0	0	1	0	0

## 10. Limiting values

**Table 18. Limiting values**

In accordance with the Absolute Maximum Rating System (IEC 60134).

Symbol	Parameter	Conditions	Min	Max	Unit
V <sub>P</sub>	supply voltage		-	5.5	V
V <sub>n</sub>	voltage on				
	pins VIF1, VIF2, SIF1, SIF2, OP1, OP2, V <sub>P</sub> and FMPLL		0	V <sub>P</sub>	V
	pin TAGC		0	8.8	V
t <sub>sc</sub>	short-circuit time	to ground or V <sub>P</sub>	-	10	s
T <sub>stg</sub>	storage temperature		-25	+150	°C
T <sub>amb</sub>	ambient temperature	TDA9885T (SO24), TDA9885TS (SSOP24), TDA9886T (SO24) and TDA9886TS (SSOP24)	-20	+70	°C
		TDA9885HN (HVQFN32) and TDA9886HN (HVQFN32)	-20	+85	°C
V <sub>esd</sub>	electrostatic discharge voltage	machine model	[1] -400	+400	V
		human body model	[2] -4000	+3500	V

[1] Class C according to EIA/JESD22-A115.

[2] Class 2 according to JESD22-A114.

## 11. Thermal characteristics

**Table 19. Thermal characteristics**

Symbol	Parameter	Conditions	Typ	Unit
R <sub>th(j-a)</sub>	thermal resistance from junction to ambient	in free air		
	TDA9885T (SO24)		76	K/W
	TDA9885TS (SSOP24)		118	K/W
	TDA9885HN (HVQFN32)		40	K/W
	TDA9886T (SO24)		76	K/W
	TDA9886TS (SSOP24)		118	K/W
	TDA9886HN (HVQFN32)		40	K/W

## 12. Characteristics

**Table 20. Characteristics**

$V_P = 5\text{ V}$ ;  $T_{amb} = 25\text{ °C}$ ; see [Table 22](#) for input frequencies; B/G standard is used for the specification ( $f_{PC} = 38.9\text{ MHz}$ ;  $f_{SC} = 33.4\text{ MHz}$ ;  $PC / SC = 13\text{ dB}$ ;  $f_{mod} = 400\text{ Hz}$ ); input level  $V_{i(VIF)} = 10\text{ mV (RMS)}$  (sync level for B/G; peak white level for L); IF input from  $50\text{ }\Omega$  via broadband transformer 1 : 1; video modulation DSB; residual carrier for B/G is 10 % and for L is 3 %; video signal in accordance with "ITU-T J.63 line 17 and line 330" or "NTC-7 Composite"; measurements taken in test circuit of [Figure 26](#); unless otherwise specified.

Symbol	Parameter	Conditions	Min	Typ	Max	Unit
<b>Supply; pin V<sub>P</sub></b>						
V <sub>P</sub>	supply voltage		[1] 4.5	5.0	5.5	V
I <sub>P</sub>	supply current		52	63	70	mA
P <sub>tot</sub>	total power dissipation		-	305	385	mW
<b>Power-on reset</b>						
V <sub>P(start)</sub>	supply voltage for start of reset	decreasing supply voltage	2.5	3.0	3.5	V
V <sub>P(stop)</sub>	supply voltage for end of reset	increasing supply voltage; I <sup>2</sup> C-bus transmission enable	-	-	4.4	V
$\tau_P$	time constant (R × C) for network at pin V <sub>P</sub>	for applications without I <sup>2</sup> C-bus	1.2	-	-	$\mu\text{s}$
<b>VIF amplifier; pins VIF1 and VIF2</b>						
V <sub>i(VIF)(rms)</sub>	VIF input voltage sensitivity (RMS value)	-1 dB video at output	-	60	100	$\mu\text{V}$
V <sub>i(max)(rms)</sub>	maximum input voltage (RMS value)	+1 dB video at output	150	190	-	mV
V <sub>i(ovl)(rms)</sub>	overload input voltage (RMS value)		[2] -	-	440	mV
$\Delta V_{IF(int)}$	internal IF amplitude difference between picture and sound carrier	within AGC range; $\Delta f = 5.5\text{ MHz}$	-	0.7	-	dB
G <sub>VIF(cr)</sub>	control range VIF gain	see <a href="#">Figure 9</a>	60	66	-	dB
B <sub>VIF(-3dB)(ll)</sub>	lower limit -3 dB VIF bandwidth		-	15	-	MHz
B <sub>VIF(-3dB)(ul)</sub>	upper limit -3 dB VIF bandwidth		-	80	-	MHz
R <sub>i(dif)</sub>	differential input resistance		[3] -	2	-	k $\Omega$
C <sub>i(dif)</sub>	differential input capacitance		[3] -	3	-	pF
V <sub>I</sub>	DC input voltage		-	1.93	-	V
<b>FPLL and true synchronous video demodulator[4]</b>						
f <sub>VCO(max)</sub>	maximum oscillator frequency for carrier regeneration	$f = 2f_{PC}$	120	140	-	MHz
f <sub>VIF</sub>	vision carrier operating frequencies	see <a href="#">Table 13</a>	-	33.4	-	MHz
			-	33.9	-	MHz
			-	38.0	-	MHz
			-	38.9	-	MHz
			-	45.75	-	MHz
			-	58.75	-	MHz
$\Delta f_{VIF}$	VIF frequency window of digital acquisition help	related to f <sub>VIF</sub> ; see <a href="#">Figure 12</a>	-	$\pm 2.3$	-	MHz

**Table 20. Characteristics ...continued**

$V_P = 5\text{ V}$ ;  $T_{amb} = 25\text{ °C}$ ; see [Table 22](#) for input frequencies; B/G standard is used for the specification ( $f_{PC} = 38.9\text{ MHz}$ ;  $f_{SC} = 33.4\text{ MHz}$ ;  $PC / SC = 13\text{ dB}$ ;  $f_{mod} = 400\text{ Hz}$ ); input level  $V_{i(VIF)} = 10\text{ mV (RMS)}$  (sync level for B/G; peak white level for L); IF input from  $50\text{ }\Omega$  via broadband transformer 1 : 1; video modulation DSB; residual carrier for B/G is 10 % and for L is 3 %; video signal in accordance with "ITU-T J.63 line 17 and line 330" or "NTC-7 Composite"; measurements taken in test circuit of [Figure 26](#); unless otherwise specified.

Symbol	Parameter	Conditions	Min	Typ	Max	Unit
$t_{acq}$	acquisition time	BL = 70 kHz	[5] -	-	30	ms
$V_{i(lock)(rms)}$	input voltage sensitivity for PLL to be locked (RMS value)	measured on pins VIF1 and VIF2; maximum IF gain	-	30	70	$\mu\text{V}$
$T_{cy(dah)}$	digital acquisition help cycle time		-	64	-	$\mu\text{s}$
$K_{O(VIF)}$	VIF VCO steepness	definition: $\Delta f_{VIF} / \Delta V_{VPLL}$	-	20	-	MHz/V
$K_{D(VIF)}$	VIF phase detector steepness	definition: $\Delta V_{VPLL} / \Delta \phi_{VIF}$	-	23	-	$\mu\text{A/rad}$

**Video output 2 V; pin CVBS**

Normal mode (sound carrier trap active) and sound carrier on

$V_{o(v)(p-p)}$	video output voltage (peak-to-peak value)	see <a href="#">Figure 7</a>	1.7	2.0	2.3	V
$\Delta V_o$	video output voltage difference	difference between L and B/G standard	-12	-	+12	%
V/S	ratio between video (black-to-white) and sync level		1.90	2.33	3.00	
$V_{sync}$	sync voltage level		1.0	1.2	1.4	V
$V_{clip(u)}$	upper video clipping voltage level		$V_P - 1.1$	$V_P - 1$	-	V
$V_{clip(l)}$	lower video clipping voltage level		-	0.7	0.9	V
$R_o$	output resistance		[3] -	-	30	$\Omega$
$I_{bias(int)}$	internal bias current (DC)	for emitter-follower	1.5	2.0	-	mA
$I_{sink(o)(max)}$	maximum output sink current	AC and DC	1	-	-	mA
$I_{source(o)(max)}$	maximum output source current	AC and DC	3.9	-	-	mA
$\Delta V_{o(CVBS)}$	deviation of CVBS output voltage	50 dB gain control	-	-	0.5	dB
		30 dB gain control	-	-	0.1	dB
$\Delta V_{o(bl)}$	black level tilt	negative modulation	-	-	1	%
$\Delta V_{o(bl)(v)}$	vertical black level tilt for worst case in L standard	vision carrier modulated by test line (VITS) only	-	-	3	%
$G_{dif}$	differential gain	"ITU-T J.63 line 330"	[6]			
		B/G standard	-	-	5	%
		L standard	-	-	7	%
$\phi_{dif}$	differential phase	"ITU-T J.63 line 330"	-	2	4	deg
$S/N_W$	weighted signal-to-noise ratio	unified weighting filter ("ITU-T J.61"); see <a href="#">Figure 13</a>	[7] 56	59	-	dB
$S/N_{UW}$	unweighted signal-to-noise ratio		[7] 47	51	-	dB
$\alpha_{IM(blue)}$	intermodulation attenuation at 'blue'	see <a href="#">Figure 14</a>	[8]			
		$f = 1.1\text{ MHz}$	58	64	-	dB
		$f = 3.3\text{ MHz}$	58	64	-	dB

**Table 20. Characteristics ...continued**

$V_P = 5\text{ V}$ ;  $T_{amb} = 25\text{ }^\circ\text{C}$ ; see [Table 22](#) for input frequencies; B/G standard is used for the specification ( $f_{PC} = 38.9\text{ MHz}$ ;  $f_{SC} = 33.4\text{ MHz}$ ;  $PC/SC = 13\text{ dB}$ ;  $f_{mod} = 400\text{ Hz}$ ); input level  $V_{i(VIF)} = 10\text{ mV (RMS)}$  (sync level for B/G; peak white level for L); IF input from  $50\text{ }\Omega$  via broadband transformer 1 : 1; video modulation DSB; residual carrier for B/G is 10 % and for L is 3 %; video signal in accordance with "ITU-T J.63 line 17 and line 330" or "NTC-7 Composite"; measurements taken in test circuit of [Figure 26](#); unless otherwise specified.

Symbol	Parameter	Conditions	Min	Typ	Max	Unit
$\alpha_{IM(\text{yellow})}$	intermodulation attenuation at 'yellow'	see <a href="#">Figure 14</a>	<a href="#">[8]</a>			
		$f = 1.1\text{ MHz}$	60	66	-	dB
		$f = 3.3\text{ MHz}$	59	65	-	dB
$\Delta V_{r(PC)(\text{rms})}$	residual picture carrier (RMS value)	fundamental wave and harmonics	-	2	5	mV
$\Delta f_{\text{unw}(p-p)}$	robustness for unwanted frequency deviation of picture carrier (peak-to-peak value)	3 % residual carrier; 50 % serration pulses; L standard	<a href="#">[3]</a> -	-	12	kHz
$\Delta\phi$	robustness for modulator imbalance	0 % residual carrier; 50 % serration pulses; L standard; L-gating = 0 %	<a href="#">[3]</a> -	-	3	%
$\alpha_H$	suppression of video signal harmonics	AC load: $C_L < 20\text{ pF}$ , $R_L > 1\text{ k}\Omega$	<a href="#">[9]</a> 35	40	-	dB
$\alpha_{\text{spur}}$	suppression of spurious elements		<a href="#">[10]</a> 40	-	-	dB
$\text{PSRR}_{\text{CVBS}}$	power supply ripple rejection on pin CVBS	$f_{\text{ripple}} = 70\text{ Hz}$ ; video signal; grey level; positive and negative modulation; see <a href="#">Figure 8</a>	20	25	-	dB
M/N standard including Korea; see <a href="#">Figure 15</a>						
$B_{V(-3\text{dB})(\text{trap})}$	-3 dB video bandwidth including sound carrier trap	$f_{\text{trap}} = 4.5\text{ MHz}$	<a href="#">[11]</a> 3.95	4.05	-	MHz
$\alpha_{\text{SC}1}$	attenuation at first sound carrier	$f = 4.5\text{ MHz}$	30	36	-	dB
$\alpha_{\text{SC}1(60\text{kHz})}$	attenuation at first sound carrier $f_{\text{SC}1} \pm 60\text{ kHz}$	$f = 4.5\text{ MHz}$	21	27	-	dB
$\alpha_{\text{SC}2}$	attenuation at second sound carrier	$f = 4.724\text{ MHz}$	21	27	-	dB
$\alpha_{\text{SC}2(60\text{kHz})}$	attenuation at second sound carrier $f_{\text{SC}2} \pm 60\text{ kHz}$	$f = 4.724\text{ MHz}$	15	21	-	dB
$t_{d(g)(\text{cc})}$	group delay at color carrier frequency	$f = 3.58\text{ MHz}$ ; see <a href="#">Figure 16</a>	110	180	250	ns
B/G standard; see <a href="#">Figure 17</a>						
$B_{V(-3\text{dB})(\text{trap})}$	-3 dB video bandwidth including sound carrier trap	$f_{\text{trap}} = 5.5\text{ MHz}$	<a href="#">[11]</a> 4.90	5.00	-	MHz
$\alpha_{\text{SC}1}$	attenuation at first sound carrier	$f = 5.5\text{ MHz}$	30	36	-	dB
$\alpha_{\text{SC}1(60\text{kHz})}$	attenuation at first sound carrier $f_{\text{SC}1} \pm 60\text{ kHz}$	$f = 5.5\text{ MHz}$	24	30	-	dB
$\alpha_{\text{SC}2}$	attenuation at second sound carrier	$f = 5.742\text{ MHz}$	21	27	-	dB
$\alpha_{\text{SC}2(60\text{kHz})}$	attenuation at second sound carrier $f_{\text{SC}2} \pm 60\text{ kHz}$	$f = 5.742\text{ MHz}$	15	21	-	dB
$t_{d(g)(\text{cc})}$	group delay at color carrier frequency	$f = 4.43\text{ MHz}$ ; see <a href="#">Figure 18</a>	110	180	250	ns



**Table 20. Characteristics ...continued**

$V_P = 5\text{ V}$ ;  $T_{amb} = 25\text{ }^\circ\text{C}$ ; see [Table 22](#) for input frequencies; B/G standard is used for the specification ( $f_{PC} = 38.9\text{ MHz}$ ;  $f_{SC} = 33.4\text{ MHz}$ ;  $PC / SC = 13\text{ dB}$ ;  $f_{mod} = 400\text{ Hz}$ ); input level  $V_{i(VIF)} = 10\text{ mV (RMS)}$  (sync level for B/G; peak white level for L); IF input from  $50\text{ }\Omega$  via broadband transformer 1 : 1; video modulation DSB; residual carrier for B/G is 10 % and for L is 3 %; video signal in accordance with "ITU-T J.63 line 17 and line 330" or "NTC-7 Composite"; measurements taken in test circuit of [Figure 26](#); unless otherwise specified.

Symbol	Parameter	Conditions	Min	Typ	Max	Unit
I standard; see <a href="#">Figure 19</a>						
$B_{V(-3dB)(trap)}$	-3 dB video bandwidth including sound carrier trap	$f_{trap} = 6.0\text{ MHz}$	[11] 5.40	5.50	-	MHz
$\alpha_{SC1}$	attenuation at first sound carrier	$f = 6.0\text{ MHz}$	26	32	-	dB
$\alpha_{SC1(60kHz)}$	attenuation at first sound carrier $f_{SC1} \pm 60\text{ kHz}$	$f = 6.0\text{ MHz}$	20	26	-	dB
$\alpha_{SC2}$	attenuation at second sound carrier	$f = 6.55\text{ MHz}$	12	18	-	dB
$\alpha_{SC2(60kHz)}$	attenuation at second sound carrier $f_{SC2} \pm 60\text{ kHz}$	$f = 6.55\text{ MHz}$	10	15	-	dB
$t_{d(g)(cc)}$	group delay at color carrier frequency	$f = 4.43\text{ MHz}$	-	90	160	ns
D/K standard; see <a href="#">Figure 20</a>						
$B_{V(-3dB)(trap)}$	-3 dB video bandwidth including sound carrier trap	$f_{trap} = 6.5\text{ MHz}$	[11] 5.50	5.95	-	MHz
$\alpha_{SC1}$	attenuation at first sound carrier	$f = 6.5\text{ MHz}$	26	32	-	dB
$\alpha_{SC1(60kHz)}$	attenuation at first sound carrier $f_{SC1} \pm 60\text{ kHz}$	$f = 6.5\text{ MHz}$	20	26	-	dB
$\alpha_{SC2}$	attenuation at second sound carrier	$f = 6.742\text{ MHz}$	18	24	-	dB
$\alpha_{SC2(60kHz)}$	attenuation at second sound carrier $f_{SC2} \pm 60\text{ kHz}$	$f = 6.742\text{ MHz}$	13	18	-	dB
$t_{d(g)(cc)}$	group delay at color carrier frequency	$f = 4.28\text{ MHz}$	-	60	130	ns
<b>Video output 1.1 V; pin CVBS</b>						
Trap bypass mode and sound carrier off[12]						
$V_{O(v)(p-p)}$	video output voltage (peak-to-peak value)	see <a href="#">Figure 7</a>	0.95	1.10	1.25	V
$V_{sync}$	sync voltage level		1.35	1.5	1.6	V
$V_{clip(u)}$	upper video clipping voltage level		3.5	3.6	-	V
$V_{clip(l)}$	lower video clipping voltage level		-	0.9	1.0	V
$B_{V(-1dB)}$	-1 dB video bandwidth	AC load: $C_L < 20\text{ pF}$ , $R_L > 1\text{ k}\Omega$	5	6	-	MHz
$B_{V(-3dB)}$	-3 dB video bandwidth	AC load: $C_L < 20\text{ pF}$ , $R_L > 1\text{ k}\Omega$	7	8	-	MHz
$S/N_W$	weighted signal-to-noise ratio	unified weighting filter ("ITU-T J.61"); see <a href="#">Figure 13</a>	[7] 56	59	-	dB
$S/N_{UW}$	unweighted signal-to-noise ratio		[7] 48	52	-	dB

**Table 20. Characteristics ...continued**

$V_P = 5\text{ V}$ ;  $T_{amb} = 25\text{ °C}$ ; see [Table 22](#) for input frequencies; B/G standard is used for the specification ( $f_{PC} = 38.9\text{ MHz}$ ;  $f_{SC} = 33.4\text{ MHz}$ ;  $PC / SC = 13\text{ dB}$ ;  $f_{mod} = 400\text{ Hz}$ ); input level  $V_{i(VIF)} = 10\text{ mV (RMS)}$  (sync level for B/G; peak white level for L); IF input from  $50\text{ }\Omega$  via broadband transformer 1 : 1; video modulation DSB; residual carrier for B/G is 10 % and for L is 3 %; video signal in accordance with "ITU-T J.63 line 17 and line 330" or "NTC-7 Composite"; measurements taken in test circuit of [Figure 26](#); unless otherwise specified.

Symbol	Parameter	Conditions	Min	Typ	Max	Unit
<b>VIF AGC</b> <a href="#">[13]</a>						
$t_{resp(inc)}$	AGC response time to an increasing VIF step	negative modulation; 20 dB <a href="#">[14]</a>	-	4	-	ms
		positive modulation; 20 dB <a href="#">[14]</a>	-	2.6	-	ms
$t_{resp(dec)}$	AGC response time to a decreasing VIF step	negative modulation; 20 dB <a href="#">[14]</a>	-	3	-	ms
		positive modulation; 20 dB <a href="#">[14]</a>	-	890	-	ms
		L standard; fast mode	-	2.6	-	ms/dB
		L standard; normal mode <a href="#">[14]</a>	-	143	-	ms/dB
$\Delta V_{i(VIF)}$	VIF amplitude step for activating AGC fast mode	L standard	-2	-6	-10	dB
$V_{VAGC}$	gain control voltage range	see <a href="#">Figure 9</a>	0.8	-	3.5	V
$CR_{stps}$	control steepness	definition: $\Delta G_{VIF} / \Delta V_{VAGC}$ ; $V_{VAGC} = 2\text{ V to }3\text{ V}$	-	-80	-	dB/V
$V_{th(VIF)}$	threshold voltage for high level VIF input	see <a href="#">Table 6</a> and <a href="#">Table 7</a>	120	200	320	$\mu\text{V}$
<b>Pin VAGC</b>						
$I_{ch(max)}$	maximum charge current	L standard	-	100	-	$\mu\text{A}$
$I_{ch(add)}$	additional charge current	L standard: in the event of missing VITS pulses and no white video content	-	100	-	nA
$I_{dch}$	discharge current	L standard; normal mode	-	35	-	nA
		L standard; fast mode	-	1.8	-	$\mu\text{A}$
<b>Tuner AGC; pin TAGC; see <a href="#">Figure 9</a> to <a href="#">Figure 11</a></b>						
$V_{i(VIF)(start1)(rms)}$	VIF input signal voltage for minimum starting point of tuner takeover at pins VIF1 and VIF2 (RMS value)	$I_{TAGC} = 120\text{ }\mu\text{A}$ ; $R_{TOP} = 22\text{ k}\Omega$ or no $R_{TOP}$ and -15 dB via I <sup>2</sup> C-bus (see <a href="#">Table 12</a> )	-	2	5	mV
$V_{i(VIF)(start2)(rms)}$	VIF input signal voltage for maximum starting point of tuner takeover at pins VIF1 and VIF2 (RMS value)	$I_{TAGC} = 120\text{ }\mu\text{A}$ ; $R_{TOP} = 0\text{ }\Omega$ or no $R_{TOP}$ and +15 dB via I <sup>2</sup> C-bus (see <a href="#">Table 12</a> )	45	90	-	mV
$QV_{TOP}$	tuner takeover point accuracy	$I_{TAGC} = 120\text{ }\mu\text{A}$ ; $R_{TOP} = 10\text{ k}\Omega$ or no $R_{TOP}$ and 0 dB via I <sup>2</sup> C-bus (see <a href="#">Table 12</a> )	7	17	43	mV
$\Delta QV_{TOP}/\Delta T$	takeover point variation with temperature	$I_{TAGC} = 120\text{ }\mu\text{A}$	-	0.03	0.07	dB/K
$V_o$	permissible output voltage	from external source	-	-	8.8	V
$V_{sat}$	saturation voltage	$I_{TAGC} = 450\text{ }\mu\text{A}$	-	-	0.5	V
$I_{sink}$	sink current	no tuner gain reduction; $V_{TAGC} = 8.8\text{ V}$	-	-	0.75	$\mu\text{A}$
		maximum tuner gain reduction; $V_{TAGC} = 1\text{ V}$	450	600	750	$\mu\text{A}$

I<sup>2</sup>C-bus controlled multistandard alignment-free IF-PLL demodulators**Table 20. Characteristics ...continued**

$V_P = 5\text{ V}$ ;  $T_{amb} = 25\text{ }^\circ\text{C}$ ; see [Table 22](#) for input frequencies; B/G standard is used for the specification ( $f_{PC} = 38.9\text{ MHz}$ ;  $f_{SC} = 33.4\text{ MHz}$ ;  $PC / SC = 13\text{ dB}$ ;  $f_{mod} = 400\text{ Hz}$ ); input level  $V_{i(VIF)} = 10\text{ mV (RMS)}$  (sync level for B/G; peak white level for L); IF input from  $50\text{ }\Omega$  via broadband transformer 1 : 1; video modulation DSB; residual carrier for B/G is 10 % and for L is 3 %; video signal in accordance with "ITU-T J.63 line 17 and line 330" or "NTC-7 Composite"; measurements taken in test circuit of [Figure 26](#); unless otherwise specified.

Symbol	Parameter	Conditions	Min	Typ	Max	Unit
$\Delta G_{IF}$	IF slip by automatic gain control	tuner gain current from 20 % to 80 %	3	5	8	dB
<b>AFC circuit; pin AFC<sup>[15][16]</sup>; see <a href="#">Figure 12</a></b>						
$V_{sat(ul)}$	upper limit saturation voltage		$V_P - 0.6$	$V_P - 0.3$	-	V
$V_{sat(ll)}$	lower limit saturation voltage		-	0.3	0.6	V
$I_{source(o)}$	output source current		160	200	240	$\mu\text{A}$
$I_{sink(o)}$	output sink current		160	200	240	$\mu\text{A}$
$AFC_{stps}$	AFC control steepness	definition: $\Delta I_{AFC} / \Delta f_{VIF}$	0.85	1.05	1.25	$\mu\text{A/kHz}$
$Qf_{VIF(a)}$	analog accuracy of AFC circuit	$I_{AFC} = 0\text{ }\mu\text{A}$ ; $f_{REF} = 4\text{ MHz}$	-20	-	+20	kHz
$Qf_{VIF(d)}$	digital accuracy of AFC circuit via I <sup>2</sup> C-bus	$I_{AFC} = 0\text{ }\mu\text{A}$ ; $f_{REF} = 4\text{ MHz}$ ; 1 digit = 25 kHz	-20 - 1 digit	-	+20 + 1 digit	kHz
<b>SIF amplifier; pins SIF1 and SIF2</b>						
$V_{i(SIF)(rms)}$	SIF input voltage sensitivity (RMS value)	FM mode; -3 dB at intercarrier output pin SIOMAD AM mode; -3 dB at AF output pin AUD	-	30	70	$\mu\text{V}$
$V_{i(max)(rms)}$	maximum input voltage (RMS value)	FM mode; +1 dB at intercarrier output pin SIOMAD AM mode; +1 dB at AF output pin AUD	50	70	-	mV
$V_{i(ovl)(rms)}$	overload input voltage (RMS value)		<a href="#">[2]</a> -	-	320	mV
$G_{SIF(cr)}$	SIF gain control range	FM and AM mode; see <a href="#">Figure 11</a>	60	66	-	dB
$B_{SIF(-3dB)(ll)}$	lower limit -3 dB SIF bandwidth		-	15	-	MHz
$B_{SIF(-3dB)(ul)}$	upper limit -3 dB SIF bandwidth		-	80	-	MHz
$R_{i(dif)}$	differential input resistance		<a href="#">[3]</a> -	2	-	k $\Omega$
$C_{i(dif)}$	differential input capacitance		<a href="#">[3]</a> -	3	-	pF
$V_I$	DC input voltage		-	1.93	-	V
<b>SIF-AGC detector</b>						
$t_{resp}$	AGC response time to an increasing or decreasing SIF step of 20 dB	FM or AM fast step increasing decreasing AM slow step increasing decreasing	- - - - -	8 25 80 250	- - - -	ms ms ms ms

**Table 20. Characteristics ...continued**

$V_P = 5\text{ V}$ ;  $T_{amb} = 25\text{ °C}$ ; see [Table 22](#) for input frequencies; B/G standard is used for the specification ( $f_{PC} = 38.9\text{ MHz}$ ;  $f_{SC} = 33.4\text{ MHz}$ ;  $PC / SC = 13\text{ dB}$ ;  $f_{mod} = 400\text{ Hz}$ ); input level  $V_{i(VIF)} = 10\text{ mV (RMS)}$  (sync level for B/G; peak white level for L); IF input from  $50\text{ }\Omega$  via broadband transformer 1 : 1; video modulation DSB; residual carrier for B/G is 10 % and for L is 3 %; video signal in accordance with "ITU-T J.63 line 17 and line 330" or "NTC-7 Composite"; measurements taken in test circuit of [Figure 26](#); unless otherwise specified.

Symbol	Parameter	Conditions	Min	Typ	Max	Unit
<b>Single reference QSS intercarrier mixer; pin SIOMAD</b>						
$V_{o(intc)(rms)}$	IF intercarrier output level (RMS value)	QSS mode; SC <sub>1</sub> ; SC <sub>2</sub> off	90	140	180	mV
		L standard; without modulation	90	140	180	mV
		intercarrier mode; <a href="#">[17]</a> PC / SC <sub>1</sub> = 20 dB; SC <sub>2</sub> off	-	75	-	mV
$B_{intc(-3dB)(ul)}$	upper limit -3 dB intercarrier bandwidth		12	15	-	MHz
$\Delta V_{r(SC)(rms)}$	residual sound carrier (RMS value)	fundamental wave and harmonics				
		QSS mode	-	2	5	mV
		intercarrier mode	-	2	5	mV
$\Delta V_{r(PC)(rms)}$	residual picture carrier (RMS value)	fundamental wave and harmonics				
		QSS mode	-	2	5	mV
		intercarrier mode	-	5	20	mV
$\alpha_H$	suppression of video signal harmonics	intercarrier mode; $f_{video} = 5\text{ MHz}$	35	40	-	dB
$R_o$	output resistance		<a href="#">[3]</a> -	-	30	$\Omega$
$V_O$	DC output voltage		-	2	-	V
$I_{bias(int)}$	internal bias current (DC)	for emitter-follower	0.90	1.15	-	mA
$I_{sink(o)(max)}$	maximum output sink current	AC	0.6	0.8	-	mA
$I_{source(o)(max)}$	maximum output source current	AC	0.6	0.8	-	mA
$I_{source(o)}$	output source current	DC; MAD2 activated	<a href="#">[18]</a> 0.75	0.93	1.20	mA
<b>FM-PLL demodulator</b> <a href="#">[16][19][20][21][22][23]</a>						
<b>Sound intercarrier output; pin SIOMAD</b>						
$V_{FM(rms)}$	IF intercarrier level for gain controlled operation of FM PLL (RMS value)	corresponding PC / SC ratio at input pins VIF1 and VIF2 is 7 dB to 47 dB	3.2	-	320	mV
$V_{FM(lock)(rms)}$	IF intercarrier level for lock-in of PLL (RMS value)		-	-	2	mV
$V_{FM(det)(rms)}$	IF intercarrier level for FM carrier detect (RMS value)	see <a href="#">Table 7</a>	-	-	2.3	mV
$f_{FM}$	sound intercarrier operating FM frequencies	see <a href="#">Table 13</a>	<a href="#">[24]</a> -	4.5	-	MHz
			-	5.5	-	MHz
			-	6.0	-	MHz
			-	6.5	-	MHz

**Table 20. Characteristics ...continued**

$V_P = 5\text{ V}$ ;  $T_{amb} = 25\text{ °C}$ ; see [Table 22](#) for input frequencies; B/G standard is used for the specification ( $f_{PC} = 38.9\text{ MHz}$ ;  $f_{SC} = 33.4\text{ MHz}$ ;  $PC / SC = 13\text{ dB}$ ;  $f_{mod} = 400\text{ Hz}$ ); input level  $V_{i(VIF)} = 10\text{ mV (RMS)}$  (sync level for B/G; peak white level for L); IF input from  $50\text{ }\Omega$  via broadband transformer 1 : 1; video modulation DSB; residual carrier for B/G is 10 % and for L is 3 %; video signal in accordance with "ITU-T J.63 line 17 and line 330" or "NTC-7 Composite"; measurements taken in test circuit of [Figure 26](#); unless otherwise specified.

Symbol	Parameter	Conditions	Min	Typ	Max	Unit
<b>Audio output; pin AUD</b>						
$V_{o(AF)(rms)}$	AF output voltage (RMS value)	25 kHz FM deviation; 75 $\mu$ s de-emphasis	400	500	600	mV
		27 kHz FM deviation; 50 $\mu$ s de-emphasis	430	540	650	mV
$V_{o(AF)(cl)(rms)}$	AF output clipping level (RMS value)	THD < 1.5 %	1.3	1.4	-	V
$\Delta V_{o(AF)/\Delta T}$	AF output voltage variation with temperature		-	$3 \times 10^{-3}$	$7 \times 10^{-3}$	dB/K
THD	total harmonic distortion	25 kHz FM deviation; 50 $\mu$ s de-emphasis	-	0.15	0.50	%
$\Delta f_{AF}$	frequency deviation	THD < 1.5 %	<a href="#">[20]</a> -	-	$\pm 55$	kHz
		-6 dB AF output via I <sup>2</sup> C-bus	<a href="#">[20]</a> -	-	$\pm 110$	kHz
$B_{AF(-3dB)}$	-3 dB AF bandwidth	without de-emphasis; measured with FM-PLL filter of <a href="#">Figure 26</a>	80	100	-	kHz
$S/N_{W(AF)}$	weighted signal-to-noise ratio of audio signal	FM PLL only; 27 kHz FM deviation; 50 $\mu$ s de-emphasis	52	56	-	dB
		black picture; see <a href="#">Figure 21</a>	50	56	-	dB
$\Delta V_{r(SC)(rms)}$	residual sound carrier (RMS value)	fundamental wave and harmonics; without de-emphasis	-	-	2	mV
$\alpha_{AM(sup)}$	AM suppression of FM demodulator	referenced to 27 kHz FM deviation; 50 $\mu$ s de-emphasis; AM: $f = 1\text{ kHz}$ ; $m = 54\%$	40	46	-	dB
$PSRR_{FM}$	power supply ripple rejection	$f_{ripple} = 70\text{ Hz}$ ; see <a href="#">Figure 8</a>	14	20	-	dB
<b>FM-PLL filter; pin FMPLL</b>						
$V_{loop}$	DC loop voltage		1.5	-	3.3	V
$I_{source(o)PD(max)}$	maximum phase detector output source current		-	60	-	$\mu$ A
$I_{sink(o)PD(max)}$	maximum phase detector output sink current		-	60	-	$\mu$ A
$I_{source(o)(dah)}$	digital acquisition help output source current		<a href="#">[24]</a> -	55	-	$\mu$ A
$I_{sink(o)(dah)}$	digital acquisition help output sink current		<a href="#">[24]</a> -	55	-	$\mu$ A
$t_{w(dah)}$	digital acquisition help pulse width		<a href="#">[24]</a> -	16	-	$\mu$ s
$T_{cy(dah)}$	digital acquisition help cycle time		<a href="#">[24]</a> -	64	-	$\mu$ s

**Table 20. Characteristics ...continued**

$V_P = 5\text{ V}$ ;  $T_{amb} = 25\text{ °C}$ ; see [Table 22](#) for input frequencies; B/G standard is used for the specification ( $f_{PC} = 38.9\text{ MHz}$ ;  $f_{SC} = 33.4\text{ MHz}$ ;  $PC / SC = 13\text{ dB}$ ;  $f_{mod} = 400\text{ Hz}$ ); input level  $V_{i(VIF)} = 10\text{ mV (RMS)}$  (sync level for B/G; peak white level for L); IF input from  $50\text{ }\Omega$  via broadband transformer 1 : 1; video modulation DSB; residual carrier for B/G is 10 % and for L is 3 %; video signal in accordance with "ITU-T J.63 line 17 and line 330" or "NTC-7 Composite"; measurements taken in test circuit of [Figure 26](#); unless otherwise specified.

Symbol	Parameter	Conditions	Min	Typ	Max	Unit
$K_{O(FM)}$	VCO steepness	definition: $\Delta f_{FM} / \Delta V_{FMPLL}$	-	3.3	-	MHz/V
$K_{D(FM)}$	phase detector steepness	definition: $\Delta I_{FMPLL} / \Delta \phi_{FM}$	-	4	-	$\mu\text{A/rad}$
<b>Audio amplifier</b>						
<b>De-emphasis network; pin DEEM</b>						
$R_o$	output resistance	50 $\mu\text{s}$ de-emphasis; see <a href="#">Table 11</a>	4.4	5.0	5.6	$\text{k}\Omega$
		75 $\mu\text{s}$ de-emphasis; see <a href="#">Table 11</a>	6.6	7.5	8.4	$\text{k}\Omega$
$V_{AF(rms)}$	audio signal (RMS value)	$f_{AF} = 400\text{ Hz}$ ; $V_{AUD} = 500\text{ mV}$	-	170	-	mV
$V_o$	DC output voltage		-	2.37	-	V
<b>AF decoupling; pin AFD</b>						
$V_{dec}$	decoupling voltage (DC)	dependent on $f_{FM}$ intercarrier frequency	1.5	-	3.3	V
$I_L$	leakage current	$\Delta V_{O(AUD)} < \pm 50\text{ mV}$	-	-	$\pm 25$	nA
$I_{ch(max)}$	maximum charge current		1.15	1.50	1.85	$\mu\text{A}$
$I_{dch(max)}$	maximum discharge current		1.15	1.50	1.85	$\mu\text{A}$
<b>Audio output; pin AUD</b>						
$R_o$	output resistance		[3]	-	300	$\Omega$
$V_{O(AUD)}$	DC output voltage		-	2.37	-	V
$R_L$	load resistance	AC-coupled	10	-	-	$\text{k}\Omega$
$R_{L(DC)}$	DC load resistance		100	-	-	$\text{k}\Omega$
$C_L$	load capacitance		-	-	1.5	nF
$B_{AF(-3dB)(ul)}$	upper limit -3 dB AF bandwidth of audio amplifier		150	-	-	kHz
$B_{AF(-3dB)(ll)}$	lower limit -3 dB AF bandwidth of audio amplifier		[21]	-	20	Hz
$\alpha_{mute}$	mute attenuation of AF signal	via I <sup>2</sup> C-bus	70	75	-	dB
$\Delta V_{jump}$	DC jump voltage for switching AF output to mute state or vice versa	activated by digital acquisition help or via I <sup>2</sup> C-bus mute	-	$\pm 50$	$\pm 150$	mV

**Table 20. Characteristics ...continued**

$V_P = 5\text{ V}$ ;  $T_{amb} = 25\text{ }^\circ\text{C}$ ; see [Table 22](#) for input frequencies; B/G standard is used for the specification ( $f_{PC} = 38.9\text{ MHz}$ ;  $f_{SC} = 33.4\text{ MHz}$ ;  $PC / SC = 13\text{ dB}$ ;  $f_{mod} = 400\text{ Hz}$ ); input level  $V_{i(VIF)} = 10\text{ mV (RMS)}$  (sync level for B/G; peak white level for L); IF input from  $50\text{ }\Omega$  via broadband transformer 1 : 1; video modulation DSB; residual carrier for B/G is 10 % and for L is 3 %; video signal in accordance with "ITU-T J.63 line 17 and line 330" or "NTC-7 Composite"; measurements taken in test circuit of [Figure 26](#); unless otherwise specified.

Symbol	Parameter	Conditions	Min	Typ	Max	Unit
<b>FM operation</b> <a href="#">[22][25]</a>						
Intercarrier AF performance <a href="#">[26]</a>						
S/N <sub>W</sub>	weighted signal-to-noise ratio	PC / SC ratio is 21 dB to 27 dB at pins VIF1 and VIF2				
		black picture	50	56	-	dB
		white picture	45	51	-	dB
		6 kHz sine wave (black-to-white modulation)	40	46	-	dB
		sound carrier subharmonics; $f = 2.75\text{ MHz} \pm 3\text{ kHz}$	35	40	-	dB
Single reference QSS AF performance <a href="#">[27][28]</a>						
S/N <sub>W(SC1)</sub>	weighted signal-to-noise ratio for SC <sub>1</sub>	PC / SC <sub>1</sub> ratio at pins VIF1 and VIF2; 27 kHz (54 % FM deviation); "ITU-R BS.468-4"	40	-	-	dB
		black picture	53	58	-	dB
		white picture	50	53	-	dB
		6 kHz sine wave (black-to-white modulation)	44	48	-	dB
		250 kHz square wave (black-to-white modulation)	40	45	-	dB
		sound carrier subharmonics; $f = 2.75\text{ MHz} \pm 3\text{ kHz}$	45	51	-	dB
		sound carrier subharmonics; $f = 2.87\text{ MHz} \pm 3\text{ kHz}$	46	52	-	dB

**Table 20. Characteristics ...continued**

$V_P = 5\text{ V}$ ;  $T_{amb} = 25\text{ }^\circ\text{C}$ ; see [Table 22](#) for input frequencies; B/G standard is used for the specification ( $f_{PC} = 38.9\text{ MHz}$ ;  $f_{SC} = 33.4\text{ MHz}$ ;  $PC / SC = 13\text{ dB}$ ;  $f_{mod} = 400\text{ Hz}$ ); input level  $V_{i(VIF)} = 10\text{ mV (RMS)}$  (sync level for B/G; peak white level for L); IF input from  $50\text{ }\Omega$  via broadband transformer 1 : 1; video modulation DSB; residual carrier for B/G is 10 % and for L is 3 %; video signal in accordance with "ITU-T J.63 line 17 and line 330" or "NTC-7 Composite"; measurements taken in test circuit of [Figure 26](#); unless otherwise specified.

Symbol	Parameter	Conditions	Min	Typ	Max	Unit
S/N <sub>W(SC2)</sub>	weighted signal-to-noise ratio for SC <sub>2</sub>	PC / SC <sub>2</sub> ratio at pins VIF1 and VIF2; 27 kHz (54 % FM deviation); "ITU-R BS.468-4"	40	-	-	dB
		black picture	48	55	-	dB
		white picture	46	51	-	dB
		6 kHz sine wave (black-to-white modulation)	42	46	-	dB
		250 kHz square wave (black-to-white modulation)	29	34	-	dB
		sound carrier subharmonics; $f = 2.75\text{ MHz} \pm 3\text{ kHz}$	44	50	-	dB
		sound carrier subharmonics; $f = 2.87\text{ MHz} \pm 3\text{ kHz}$	45	51	-	dB

**AM operation**

L standard; pin AUD<sup>[29]</sup>; see [Figure 22](#) and [Figure 23](#)

$V_{o(AF)(rms)}$	AF output voltage (RMS value)	54 % AM modulation	400	500	600	mV
THD	total harmonic distortion	54 % AM modulation	-	0.5	1.0	%
$B_{AF(-3dB)}$	-3 dB AF bandwidth		100	125	-	kHz
S/N <sub>W(AF)</sub>	weighted signal-to-noise ratio of audio signal	in accordance with "ITU-R BS.468-4"	45	50	-	dB
$V_{O(AUD)}$	DC potential voltage		-	2.37	-	V
PSRR <sub>AM</sub>	power supply ripple rejection	see <a href="#">Figure 8</a>	20	26	-	dB

**Reference frequency input; pin REF**

$V_I$	DC input voltage		2.3	2.6	2.9	V
$R_i$	input resistance		<a href="#">[3]</a>	5	-	k $\Omega$
$R_{xtal}$	resonance resistance of crystal	operation as crystal oscillator	-	-	200	$\Omega$
$C_x$	pull-up/down capacitance		<a href="#">[30]</a>	-	-	pF
$f_{ref}$	reference signal frequency		<a href="#">[31]</a>	4	-	MHz
$\Delta f_{ref}$	tolerance of reference signal frequency		<a href="#">[16]</a>	-	$\pm 0.1$	%
$V_{ref(rms)}$	reference signal voltage (RMS value)	operation as input terminal	80	-	400	mV
$R_{o(ref)}$	output resistance of reference signal source		-	-	4.7	k $\Omega$
$C_K$	decoupling capacitance to external reference signal source	operation as input terminal	22	100	-	pF



**Table 20. Characteristics ...continued**

$V_P = 5\text{ V}$ ;  $T_{amb} = 25\text{ }^\circ\text{C}$ ; see [Table 22](#) for input frequencies; B/G standard is used for the specification ( $f_{PC} = 38.9\text{ MHz}$ ;  $f_{SC} = 33.4\text{ MHz}$ ;  $PC/SC = 13\text{ dB}$ ;  $f_{mod} = 400\text{ Hz}$ ); input level  $V_{i(VIF)} = 10\text{ mV (RMS)}$  (sync level for B/G; peak white level for L); IF input from  $50\text{ }\Omega$  via broadband transformer 1 : 1; video modulation DSB; residual carrier for B/G is 10 % and for L is 3 %; video signal in accordance with "ITU-T J.63 line 17 and line 330" or "NTC-7 Composite"; measurements taken in test circuit of [Figure 26](#); unless otherwise specified.

Symbol	Parameter	Conditions	Min	Typ	Max	Unit
<b>I<sup>2</sup>C-bus transceiver; pins SDA and SCL <a href="#">[32]</a><a href="#">[33]</a></b>						
$f_{SCL}$	SCL clock frequency		0	-	400	kHz
$V_{IH}$	HIGH-level input voltage		3	-	$V_{CC}$	V
$V_{IL}$	LOW-level input voltage		-0.3	-	+1.5	V
$I_{IH}$	HIGH-level input current		-10	-	+10	$\mu\text{A}$
$I_{IL}$	LOW-level input current		-10	-	+10	$\mu\text{A}$
$V_{OL}$	LOW-level output voltage	$I_{OL} = 3\text{ mA}$	-	-	0.4	V
$I_{sink(o)}$	output sink current	$V_P = 0\text{ V}$	-	-	10	$\mu\text{A}$
$I_{source(o)}$	output source current	$V_P = 0\text{ V}$	-	-	10	$\mu\text{A}$
<b>Output ports; pins OP1 and OP2 <a href="#">[34]</a></b>						
$V_{OL}$	LOW-level output voltage	$I_{OL} = 2\text{ mA (sink current)}$	-	-	0.4	V
$V_{OH}$	HIGH-level output voltage		-	-	6	V
$I_{sink(o)}$	output sink current		-	-	2	mA
$I_{o(max)}$	maximum output current	sink or source; pin OP2 functions as VIF-AGC output	-	-	10	$\mu\text{A}$

[1] Values of video and sound parameters can be decreased at  $V_P = 4.5\text{ V}$ .

[2] Level headroom for input level jumps during gain control setting.

[3] This parameter is not tested during the production and is only given as application information for designing the receiver circuit.

[4] Loop bandwidth  $BL = 70\text{ kHz}$  (damping factor  $d = 1.9$ ; calculated with sync level within gain control range). Calculation of the VIF-PLL filter can be done by use of the following formula:

$$BL_{-3dB} = \frac{1}{2\pi} K_O K_D R, \text{ valid for } d \geq 1.2$$

$$d = \frac{1}{2} R \sqrt{K_O K_D C},$$

where:

$K_O$  is the VCO steepness  $\left(\frac{\text{rad}}{\text{V}}\right)$  or  $\left(2\pi\frac{\text{Hz}}{\text{V}}\right)$ ;  $K_D$  is the phase detector steepness  $\left(\frac{\mu\text{A}}{\text{rad}}\right)$ ;

$R$  is the loop resistor ( $\Omega$ );  $C$  is the loop capacitor (F);  $BL_{-3dB}$  is the loop bandwidth for -3 dB (Hz);  $d$  is the damping factor.

[5]  $V_{i(VIF)} = 10\text{ mV (RMS)}$ ;  $\Delta f = 1\text{ MHz}$  (VCO frequency offset related to the picture carrier frequency); white picture video modulation.

[6] Condition: luminance range (5 steps) from 0 % to 100 %.

[7] S/N is the ratio of black-to-white amplitude to the noise voltage (RMS value measured on pin CVBS and tested at video black level, 'quiet line'). Noise analyzer settings:  $B = 5\text{ MHz}$ , 200 kHz high-pass and sound carrier trap on. In case of  $S/N_W$  weighted in accordance with "ITU-T J.61". Measurements taken for B/G standard.

[8] The intermodulation figures are defined for:

a)  $f = 1.1\text{ MHz}$  (referenced to black and white signal) as  $\alpha_{IM} = 20 \log\left(\frac{V_0 \text{ at } 4.4\text{ MHz}}{V_0 \text{ at } 1.1\text{ MHz}}\right) + 3.6\text{ dB}$

b)  $f = 3.3\text{ MHz}$  (referenced to color carrier) as  $\alpha_{IM} = 20 \log\left(\frac{V_0 \text{ at } 4.4\text{ MHz}}{V_0 \text{ at } 3.3\text{ MHz}}\right)$

I<sup>2</sup>C-bus controlled multistandard alignment-free IF-PLL demodulators

- [9] Measurements taken with SAW filter M1963M (sound shelf: 20 dB); loop bandwidth BL = 70 kHz. Modulation VSB; sound carrier off;  $f_{\text{video}} > 0.5$  MHz.
- [10] Measurements taken with SAW filter M1963M (sound shelf: 20 dB); loop bandwidth BL = 70 kHz. Sound carrier on;  $f_{\text{video}} = 10$  kHz to 10 MHz.
- [11] AC load;  $C_L < 20$  pF and  $R_L > 1$  k $\Omega$ . The sound carrier frequencies (depending on TV standard) are attenuated by the integrated sound carrier traps (see [Figure 15](#) to [Figure 20](#);  $|H(s)|$  is the absolute value of transfer function).
- [12] The sound carrier trap can be bypassed by switching the I<sup>2</sup>C-bus. In this way the full composite video spectrum appears at pin CVBS. The amplitude is 1.1 V (p-p).
- [13] If selected by the I<sup>2</sup>C-bus, the VIF-AGC voltage can be monitored at pin OP2, and pin OP1 can be used as input. In this case, both pins cannot be used for the normal port function.
- [14] The response time is valid for a VIF input level range from 200  $\mu$ V to 70 mV.
- [15] To match the AFC output signal to different tuning systems a current output is provided. The test circuit is given in [Figure 12](#). The AFC slope (voltage per frequency) can be changed by resistors R1 and R2.
- [16] The tolerance of the reference frequency determines the accuracy of the VIF AFC, FM demodulator center frequency and maximum FM deviation.
- [17] The intercarrier output signal at pin SIOMAD can be calculated by the following formula taking into account the internal video signal with 1.1 V (p-p) as a reference:  $V_{o(\text{intc})(\text{rms})} = 1.1 \times \frac{1}{2\sqrt{2}} \times 10^r$  V and  $r = \frac{1}{20} \times \left( \frac{V_{i(\text{SC})}}{V_{i(\text{PC})}} (\text{dB}) + 6 \text{ dB} \pm 3 \text{ dB} \right)$ , where:  $\frac{1}{2\sqrt{2}}$  is the correction term for RMS value,  $\frac{V_{i(\text{SC})}}{V_{i(\text{PC})}} (\text{dB})$  is the sound-to-picture carrier ratio at pins VIF1 and VIF2 in dB, 6 dB is the correction term of internal circuitry and  $\pm 3$  dB is the tolerance of video output and intercarrier output  $V_{o(\text{intc})(\text{rms})}$ .
- [18] For normal operation (with the I<sup>2</sup>C-bus) no DC load at pin SIOMAD is allowed. The second module address (MAD2) will be activated by the application of a 2.2 k $\Omega$  resistor between pin SIOMAD and ground. If this MAD2 is activated, also the power-on set-up state activates a VIF frequency of 58.75 MHz.
- [19] SIF input level is 10 mV (RMS); VIF input level is 10 mV (RMS) unmodulated.
- [20] Measured with an FM deviation of 25 kHz and the typical AF output voltage of 500 mV (RMS). The AF output signal can be attenuated by 6 dB to 250 mV (RMS) via the I<sup>2</sup>C-bus. For handling a frequency deviation of more than 55 kHz, the AF output signal has to be reduced in order to avoid clipping (THD < 1.5 %).
- [21] The lower limit of the audio bandwidth depends on the value of the capacitor at pin AFD. A value of  $C_{\text{AF}} = 470$  nF leads to  $f_{\text{AF}(-3\text{dB})} \approx 20$  Hz and  $C_{\text{AF}} = 220$  nF leads to  $f_{\text{AF}(-3\text{dB})} \approx 40$  Hz.
- [22] For all S/N measurements the VIF modulator in use has to meet the following specifications:
- Incidental phase modulation for black-to-white jump less than 0.5 degrees
  - QSS AF performance, measured with the television demodulator AMF2 (audio output, weighted S/N ratio) better than 60 dB (at deviation 27 kHz) for 6 kHz sine wave black-to-white video modulation
  - Picture-to-sound carrier ratio PC / SC<sub>1</sub> = 13 dB (transmitter)
- [23] Calculation of the loop filter parameters can be done approximately using the following formulae:  $f_o = \frac{1}{2\pi\sqrt{\frac{K_o K_D}{C_p}}}$ ;
- $$\vartheta = \frac{1}{2R\sqrt{K_o K_D C_p}}; \text{BL}_{-3\text{dB}} = f_o(1.55 - \vartheta^2). \text{ The formulae are only valid under the following conditions: } \vartheta \leq 1 \text{ and } C_S > 5C_P, \text{ where:}$$
- $K_o$  is the VCO steepness  $\left(\frac{\text{rad}}{\text{V}}\right)$  or  $\left(2\pi\frac{\text{Hz}}{\text{V}}\right)$ ;  $K_D$  is the phase detector steepness  $\left(\frac{\mu\text{A}}{\text{rad}}\right)$ ; R is the loop resistor;  $C_S$  is the series capacitor;  $C_P$  is the parallel capacitor;  $f_o$  is the natural frequency of the PLL;  $\text{BL}_{-3\text{dB}}$  is the loop bandwidth for -3 dB;  $\vartheta$  is the damping factor. For examples, see [Table 21](#).
- [24] Window width of digital acquisition help  $\leq 237.5$  kHz.
- [25] The PC / SC ratio is calculated as the addition of TV transmitter PC / SC<sub>1</sub> ratio and SAW filter PC / SC<sub>1</sub> ratio. This PC / SC ratio is necessary to achieve the S/N<sub>w</sub> values as noted. A different PC / SC ratio will change these values.
- [26] Measurements taken with SAW filter G1984 (Siemens) for vision and sound IF (sound shelf: 14 dB). Picture-to-sound carrier ratio of transmitter PC / SC = 13 dB. Input level on pins VIF1 and VIF2 of  $V_{i(\text{SIF})} = 10$  mV (RMS) sync level, 27 kHz FM deviation for sound carrier,  $f_{\text{AF}} = 400$  Hz. Measurements in accordance with "ITU-R BS.468-4". De-emphasis is 50  $\mu$ s.
- [27] The QSS signal output on pin SIOMAD is analyzed by a test demodulator TDA9820. The S/N ratio of this device is more than 60 dB, related to a deviation of  $\pm 27$  kHz, in accordance with "ITU-R BS.468-4".

- [28] Measurements taken with SAW filter K3953 for vision IF (suppressed sound carrier) and K9453 for sound IF (suppressed picture carrier). Input level  $V_{i(SIF)} = 10$  mV (RMS), 27 kHz (54 % FM deviation).
- [29] Measurements taken with SAW filter K9453 (Siemens) for AM sound IF (suppressed picture carrier).
- [30] The value of  $C_x$  determines the accuracy of the resonance frequency of the crystal. It depends on the type of crystal used.
- [31] Pin REF is able to operate as a 1-pin crystal oscillator input as well as an external reference signal input, e.g. from the tuning system.
- [32] The SDA and SCL lines will not be pulled down if  $V_{CC}$  is switched off.
- [33] The AC characteristics are in accordance with the I<sup>2</sup>C-bus specification for fast mode (maximum clock frequency is 400 kHz). Information about the I<sup>2</sup>C-bus can be found in the brochure "The I<sup>2</sup>C-bus and how to use it" (order number 9398 393 40011).
- [34] Port P1 and port P2 are open-collector outputs.

**Table 21. Examples to the FM-PLL filter**

BL <sub>-3dB</sub> (kHz)	C <sub>S</sub> (nF)	C <sub>P</sub> (pF)	R (kΩ)	ϑ
100	10	390	5.6	0.5
160	10	150	9.1	0.5

**Table 22. Input frequencies and carrier ratios**

Symbol	Parameter	B/G standard	M/N standard	L standard	L-accent standard	Unit
f <sub>PC</sub>	picture carrier frequency	38.9	45.75 or 58.75	38.9	33.9	MHz
f <sub>SC1</sub>	sound carrier frequency 1	33.4	41.25 or 54.25	32.4	40.4	MHz
f <sub>SC2</sub>	sound carrier frequency 2	33.158	-	-	-	MHz
PC / SC <sub>1</sub>	picture to first sound carrier ratio	13	7	10	10	dB
PC / SC <sub>2</sub>	picture to second sound carrier ratio	20	-	-	-	dB

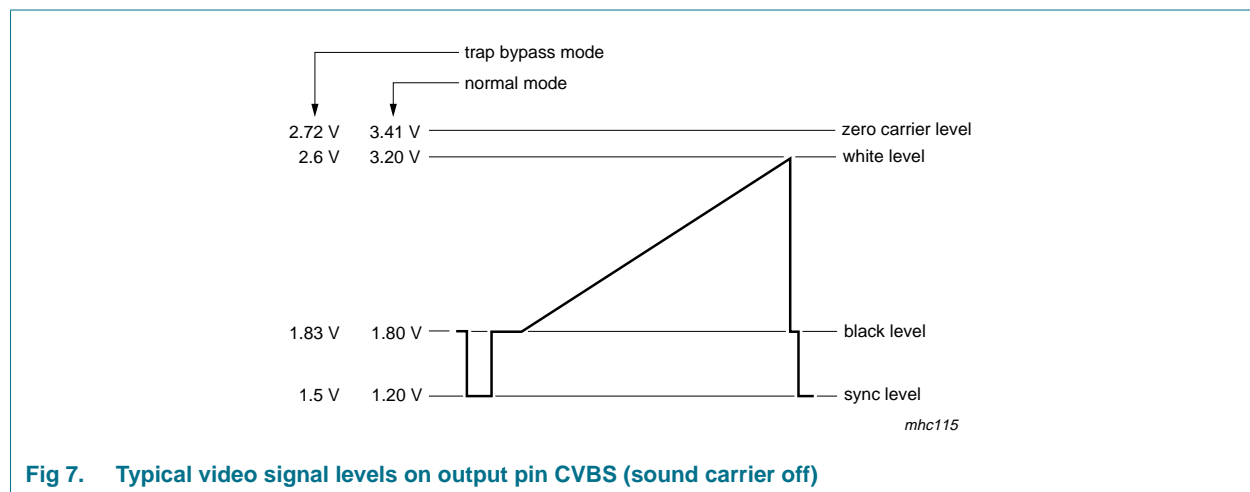

**Fig 7. Typical video signal levels on output pin CVBS (sound carrier off)**

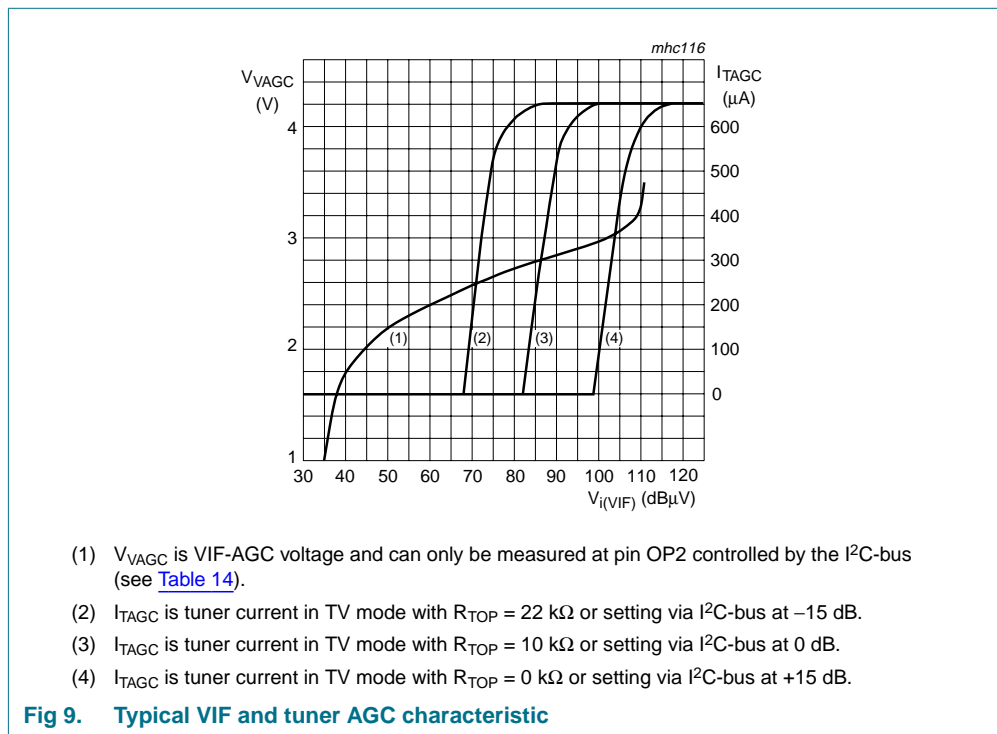
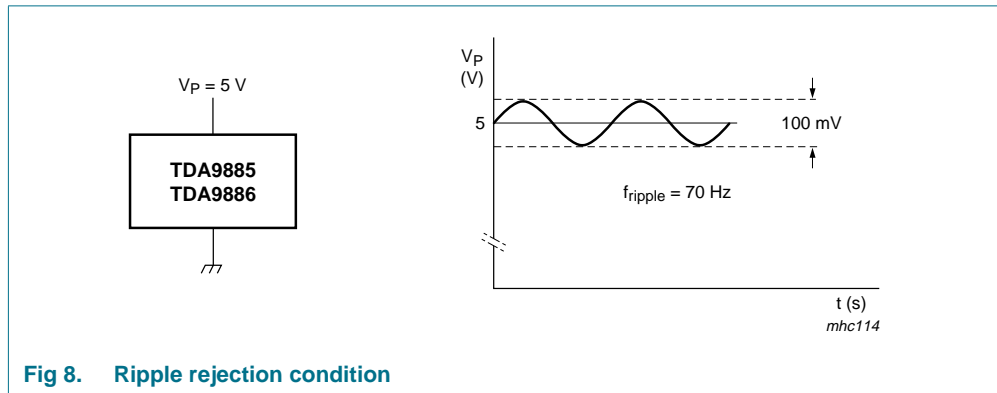

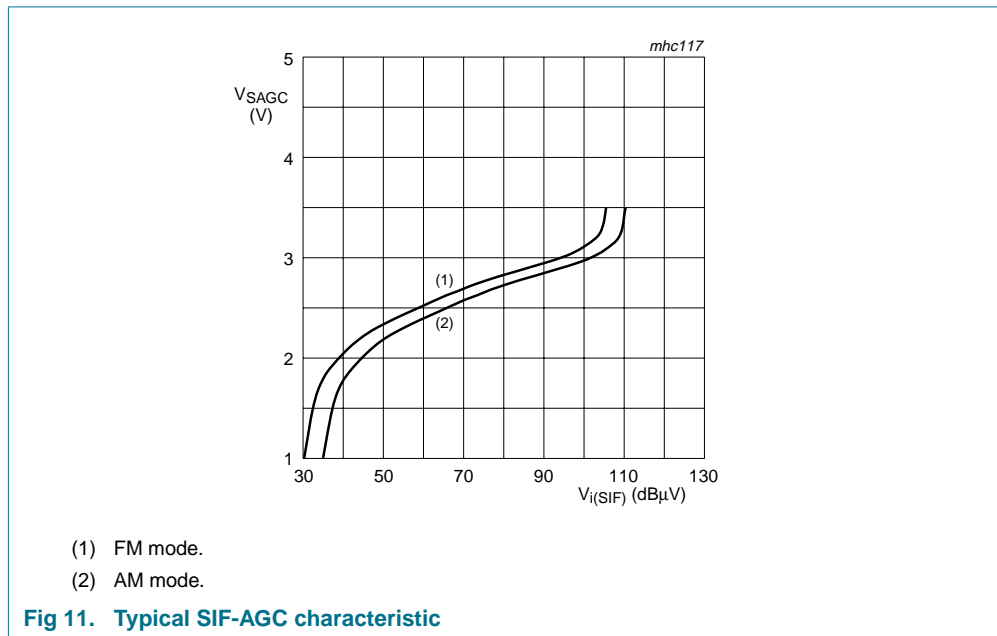
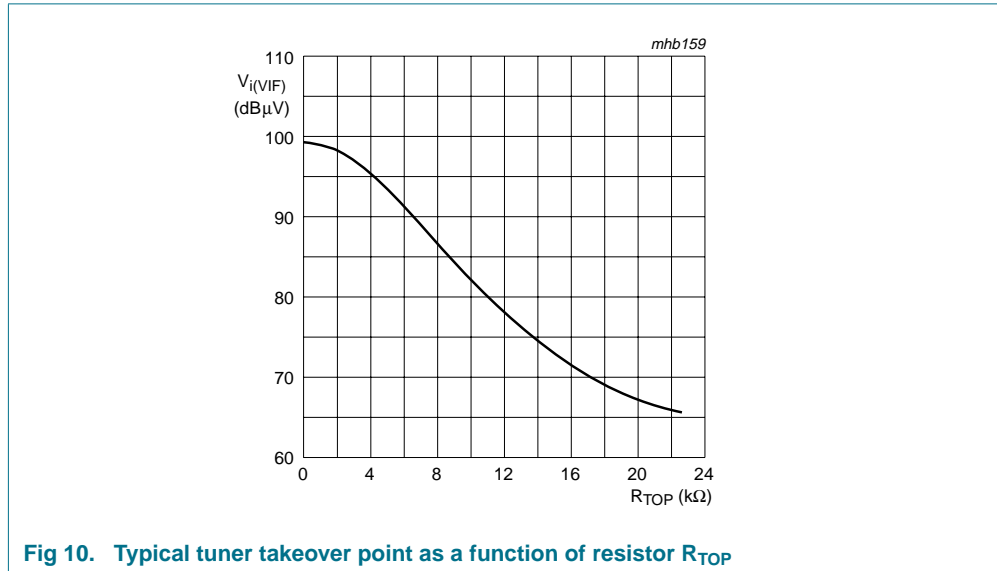

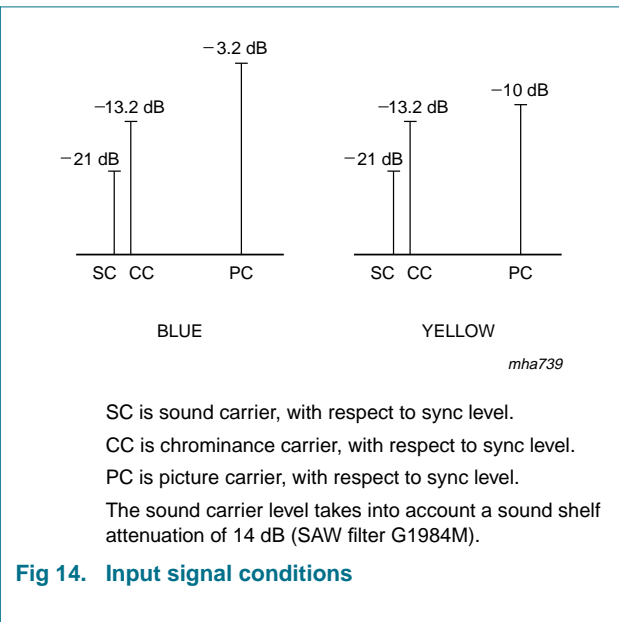
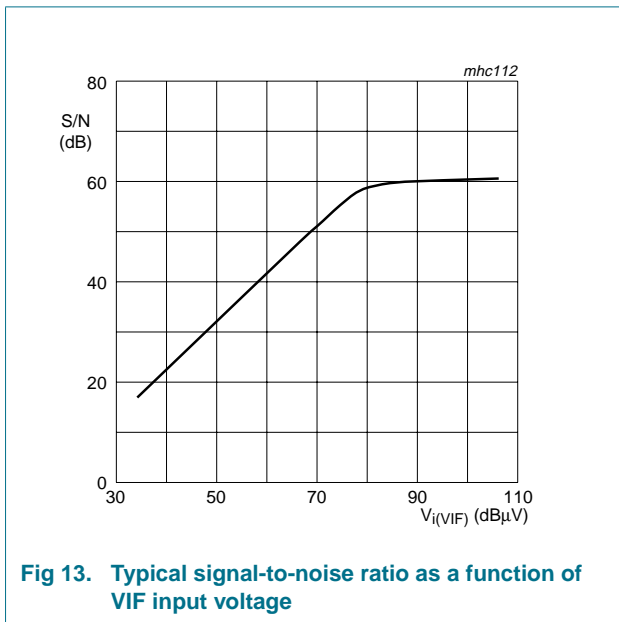
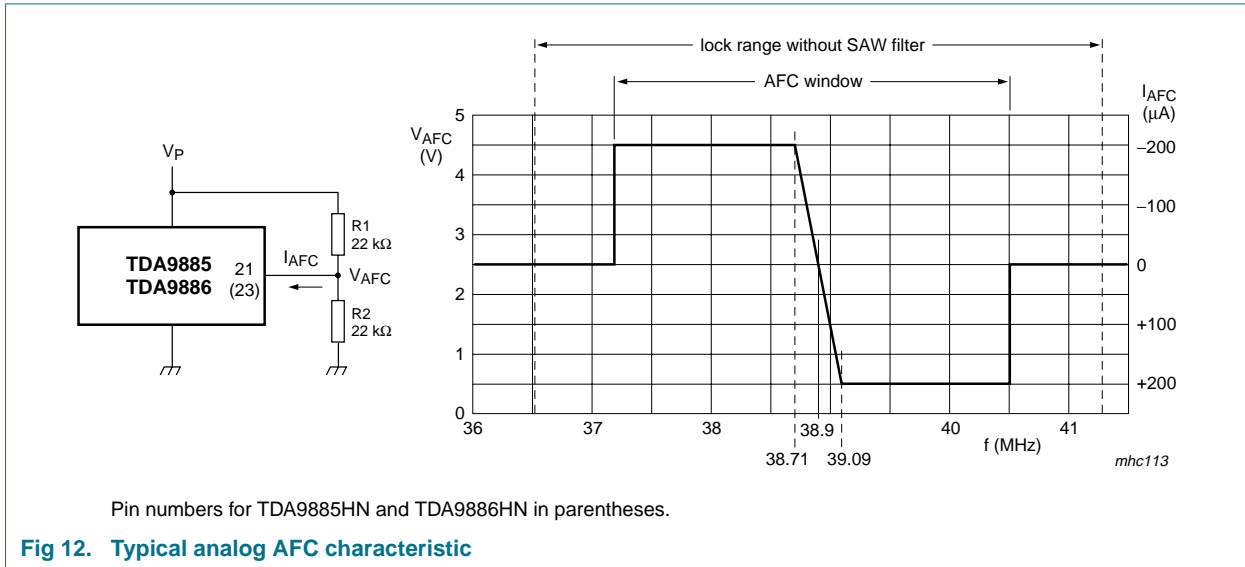

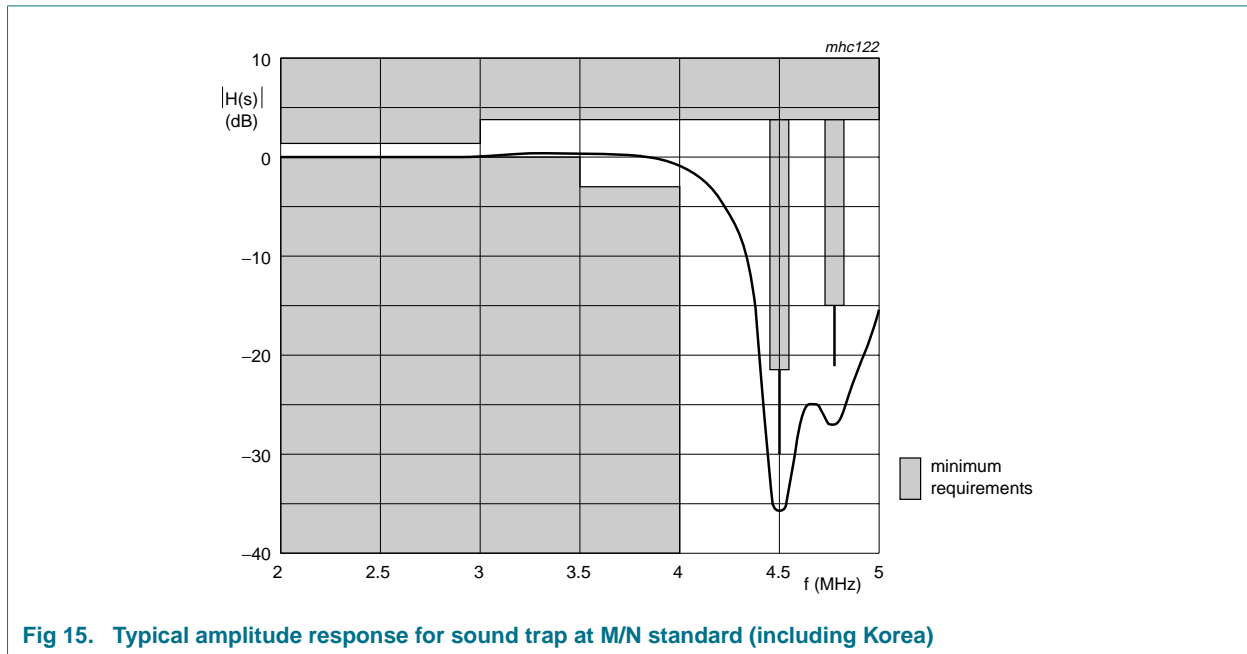
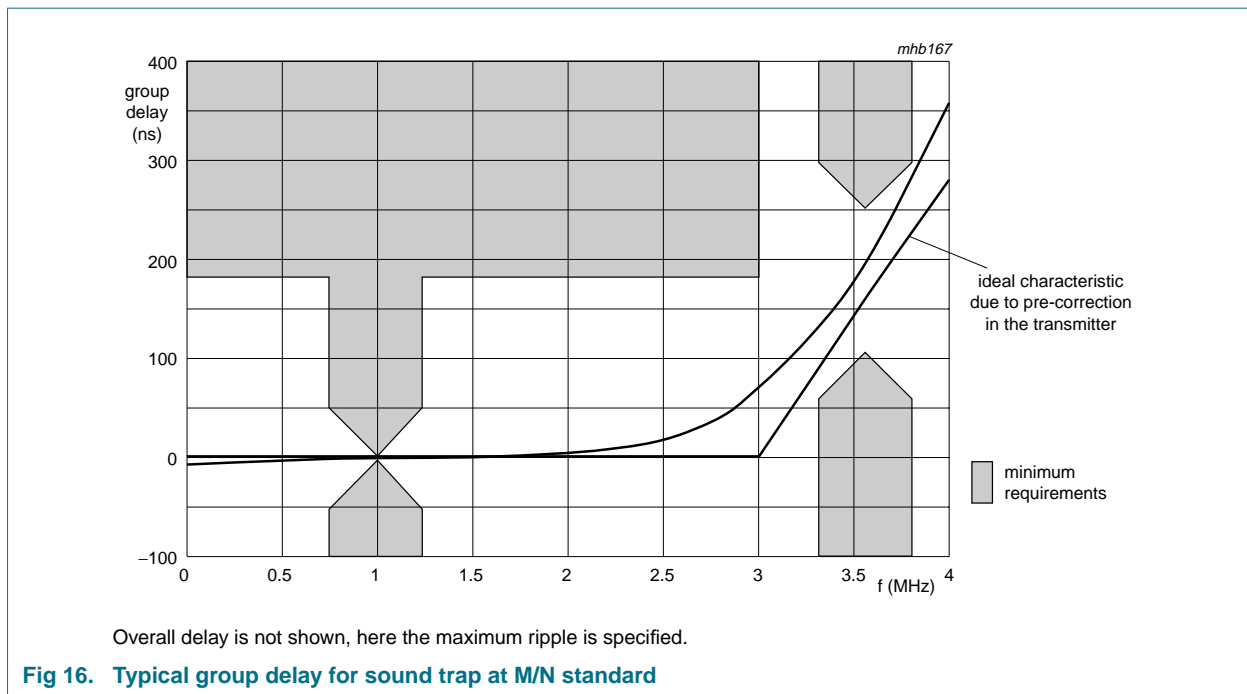
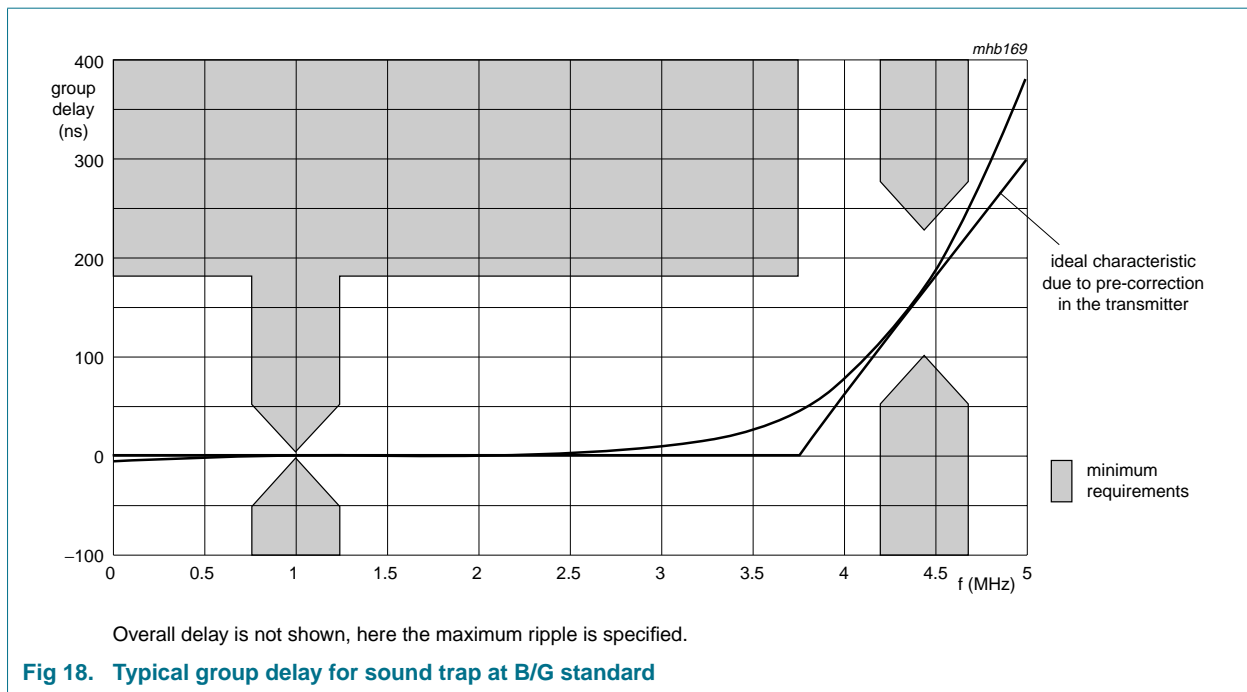
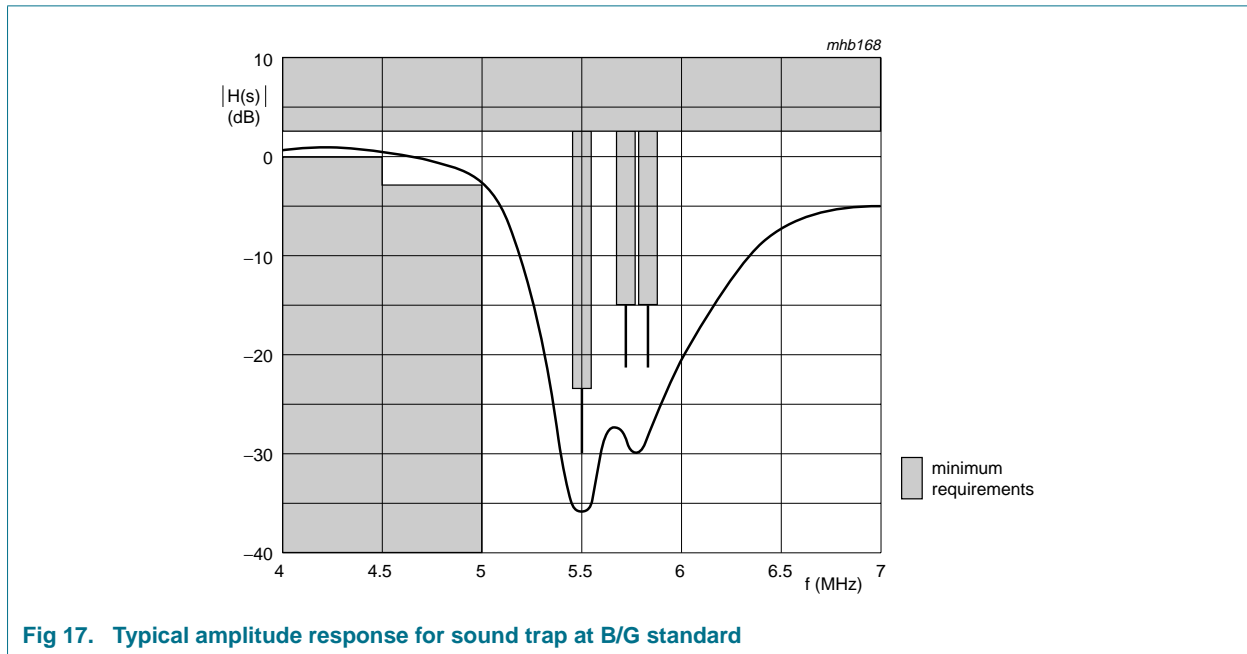

Fig 15. Typical amplitude response for sound trap at M/N standard (including Korea)



Overall delay is not shown, here the maximum ripple is specified.

Fig 16. Typical group delay for sound trap at M/N standard





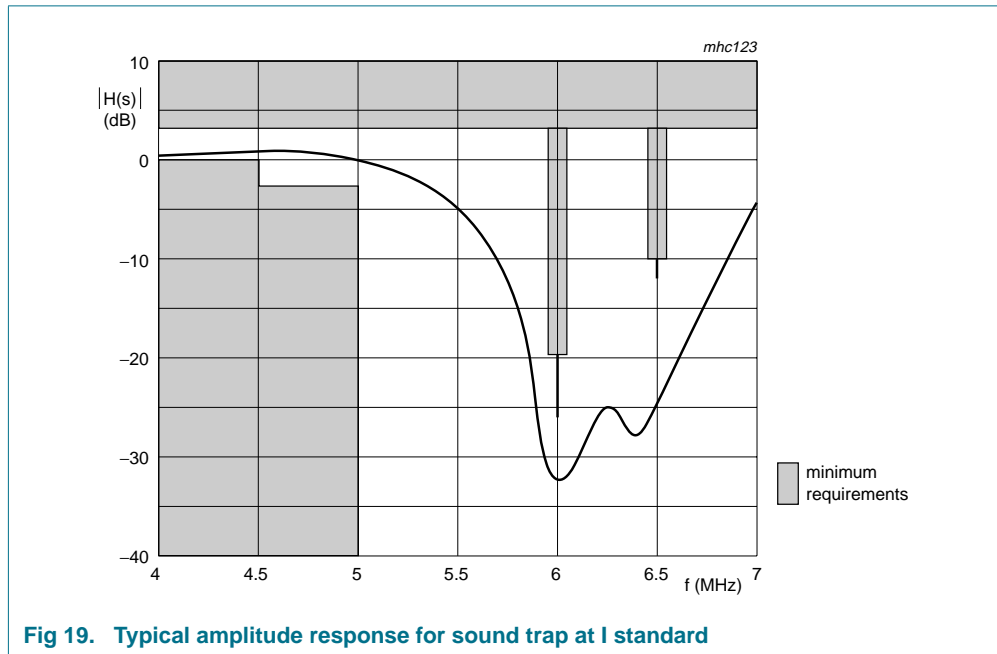

Fig 19. Typical amplitude response for sound trap at I standard

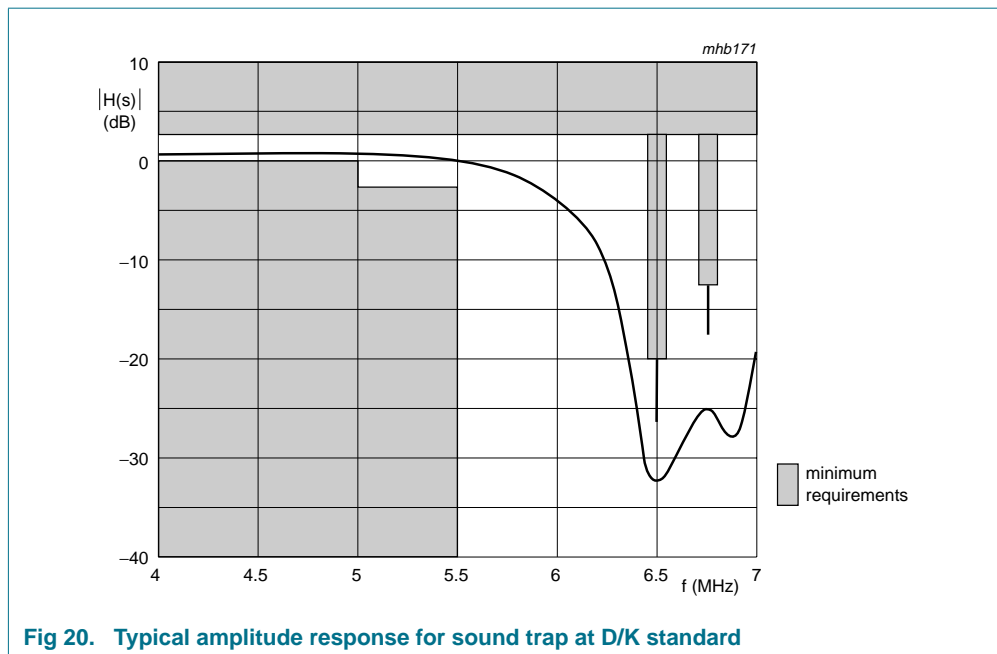
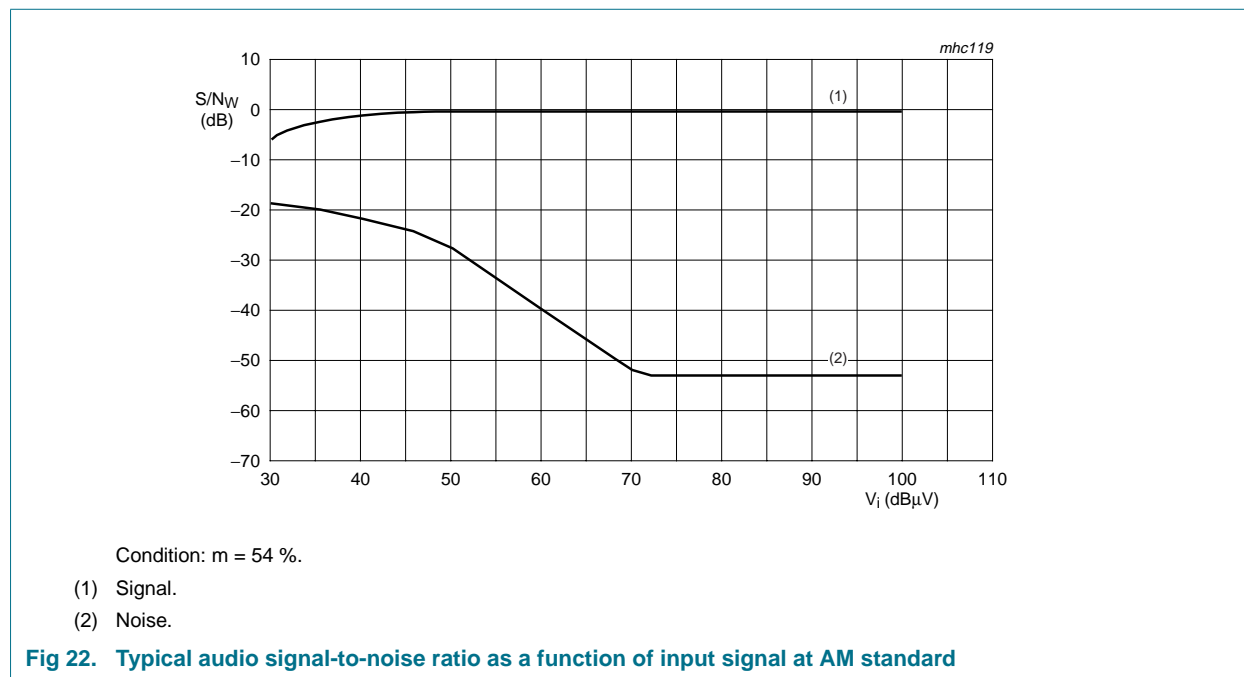
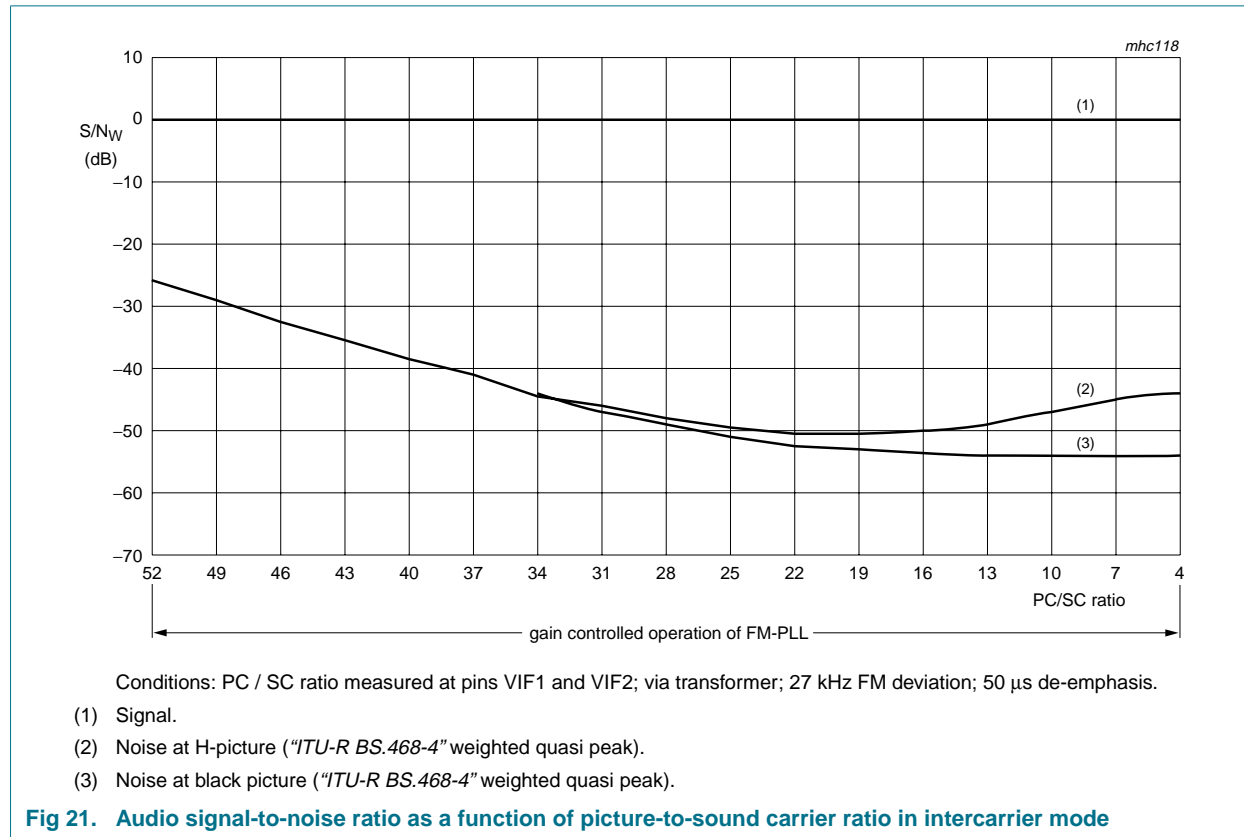
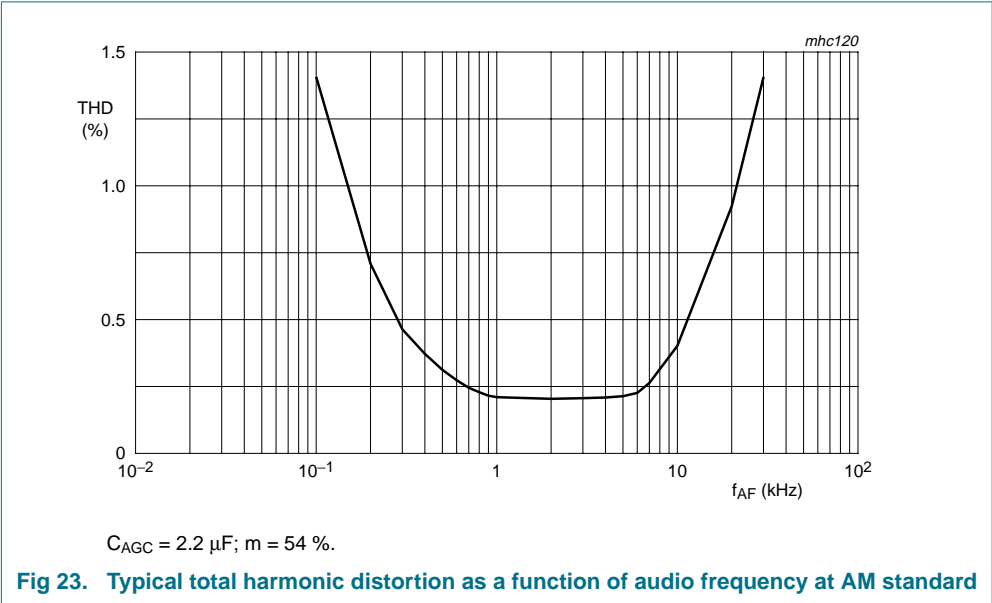
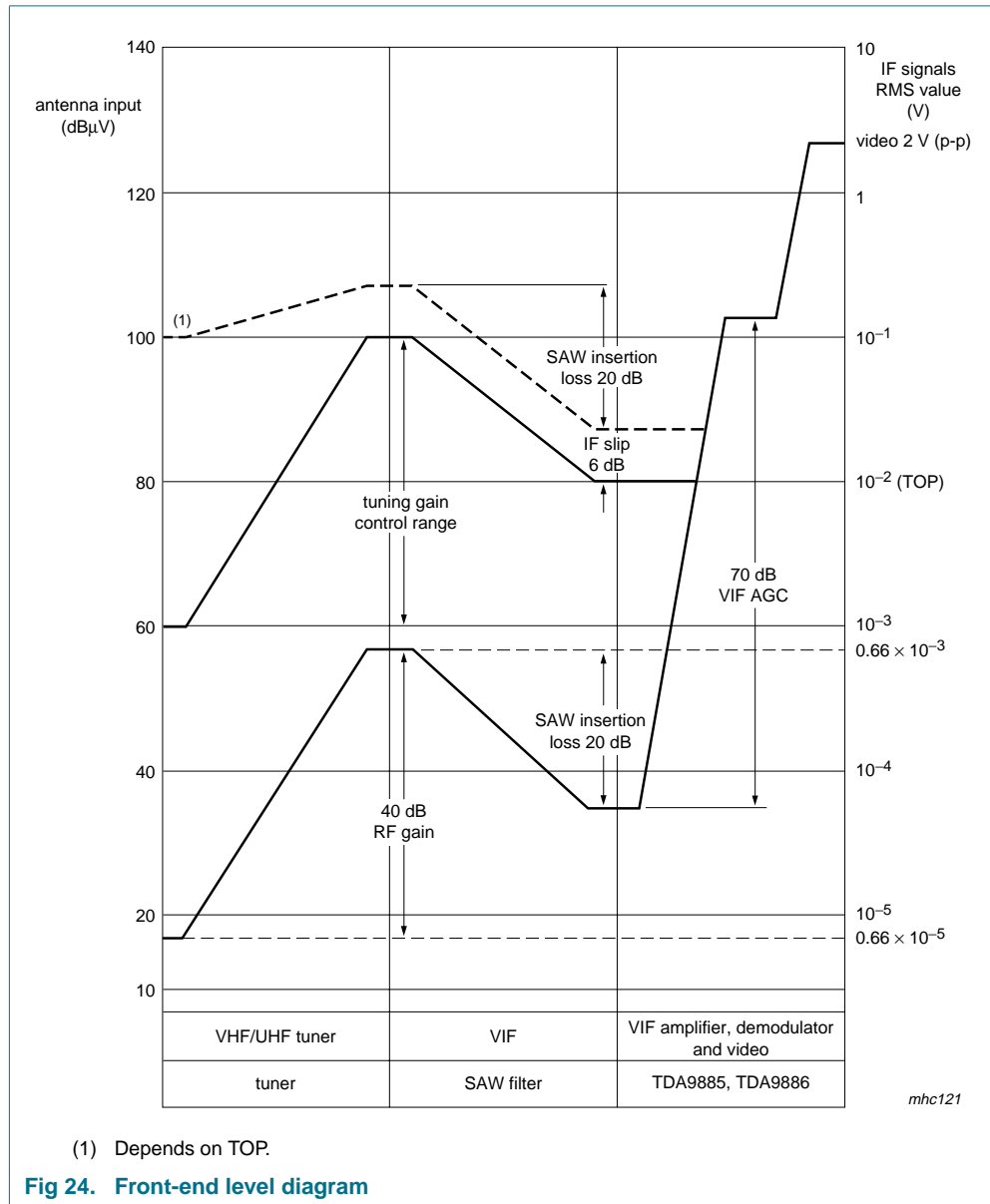

Fig 20. Typical amplitude response for sound trap at D/K standard







13. Application information

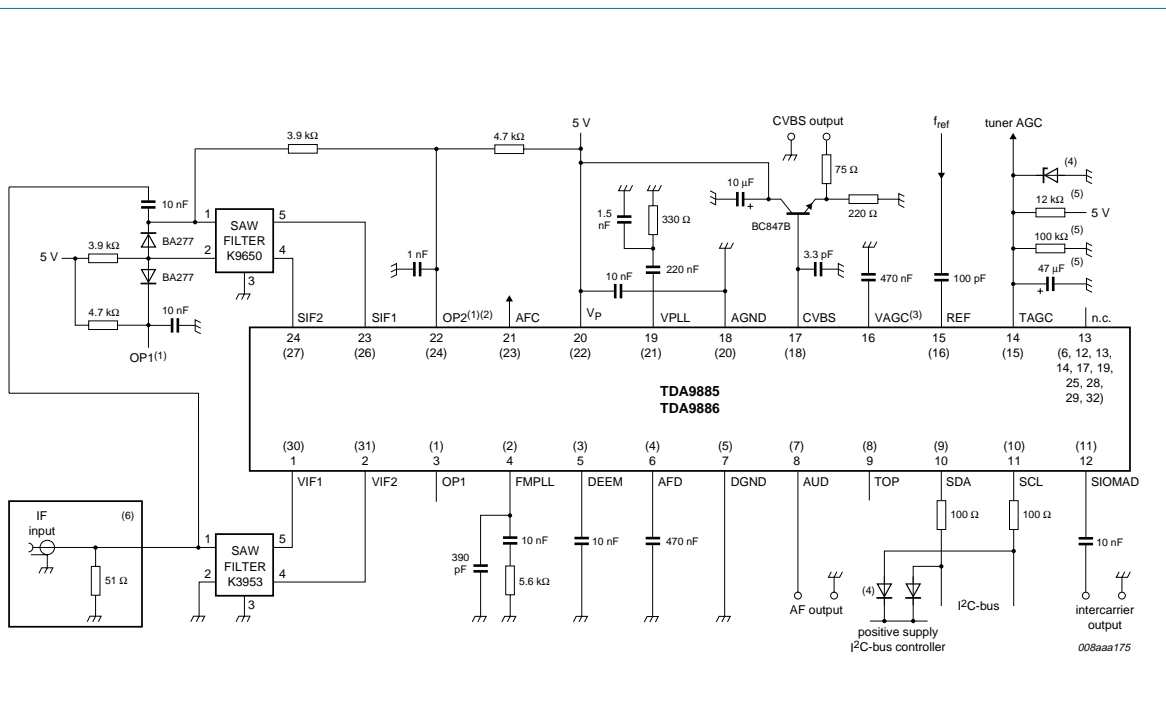

Pin numbers for TDA9885HN and TDA9886HN in parentheses.

- (1) For L-accent standard OP1 = LOW and OP2 = HIGH, in other cases OP1 = HIGH and OP2 = LOW.
- (2) If pin OP2 outputs VIF-AGC voltage, then pin OP1 can be used for SAW switching.
- (3) Not connected for TDA9885.
- (4) Optional measures to improve ESD performance within a TV-set application.
- (5) Application dependent.
- (6) For test signal input only.

Fig 25. Application diagram

14. Test information

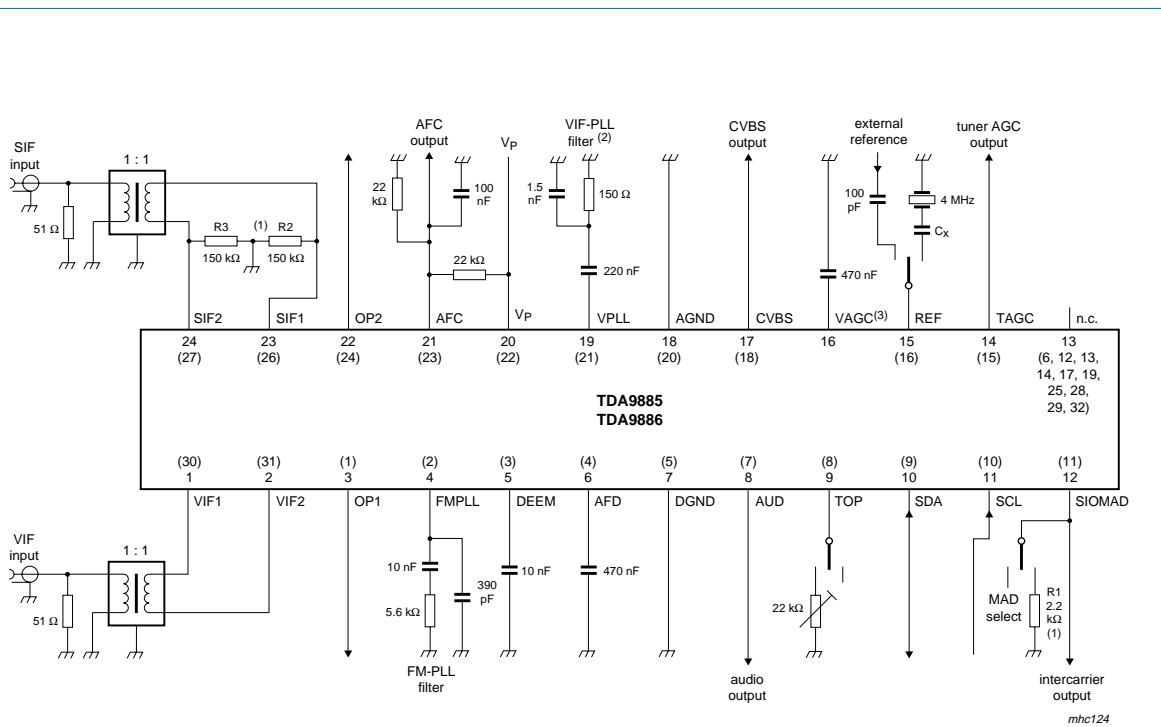

Pin numbers for TDA9885HN and TDA9886HN in parentheses.

- (1) Optional for I<sup>2</sup>C-bus address selection; see [Table 23](#).
- (2) Different VIF loop filter in comparison with the application diagram due to different input characteristics (SAW filter or transformer).
- (3) Not connected for TDA9885.

Fig 26. Test circuit

Table 23. I<sup>2</sup>C-bus address selection  
*S = R/W selection bit.*

Option	R1 not used	R1 = 2.2 kΩ
R2 and R3 not used	1000 011S	1000 010S
R2 = R3 = 150 kΩ	1001 011S	1001 010S

15. Package outline

SO24: plastic small outline package; 24 leads; body width 7.5 mm

SOT137-1

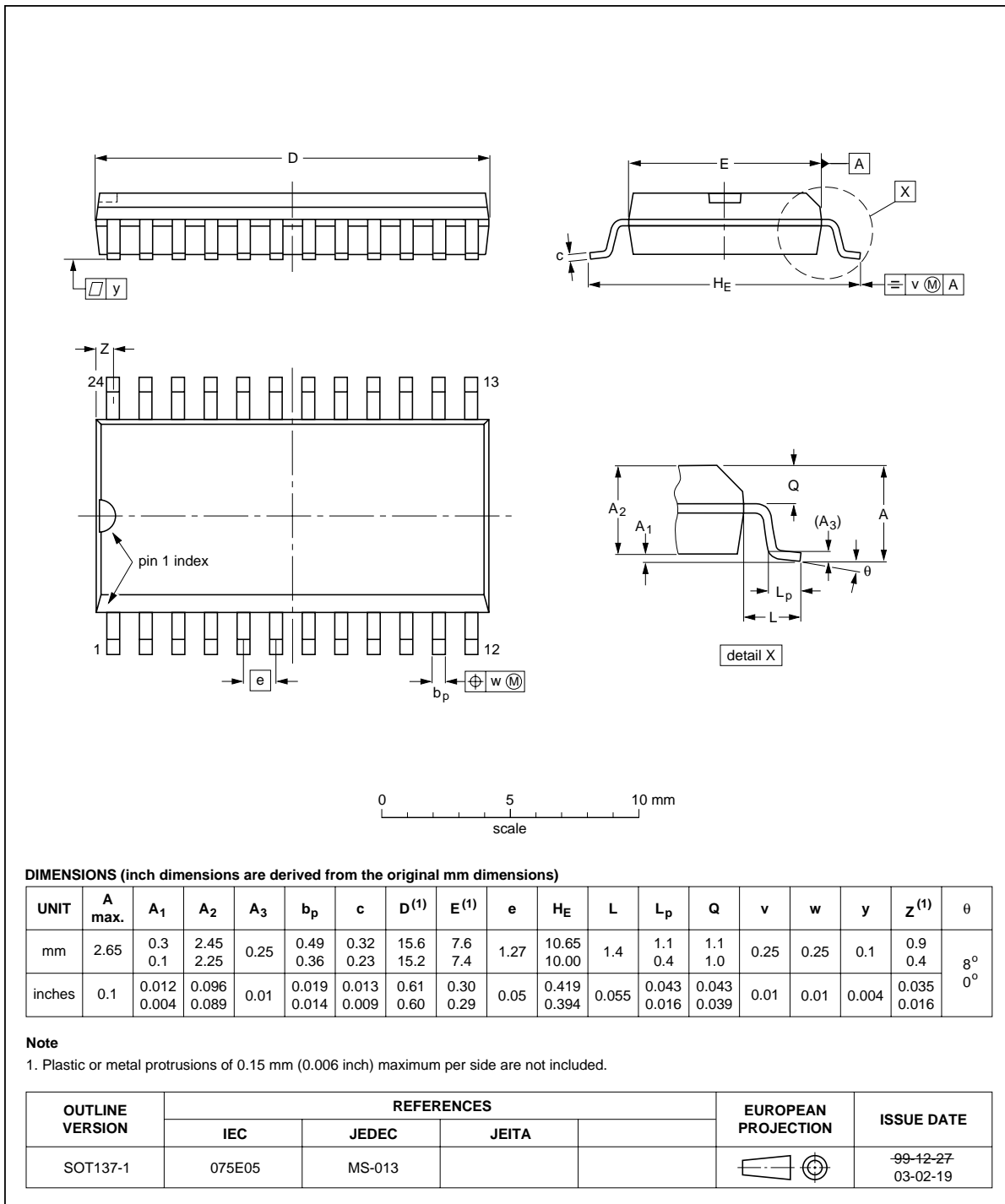

Fig 27. Package outline SOT137-1 (SO24)



SSOP24: plastic shrink small outline package; 24 leads; body width 5.3 mm

SOT340-1

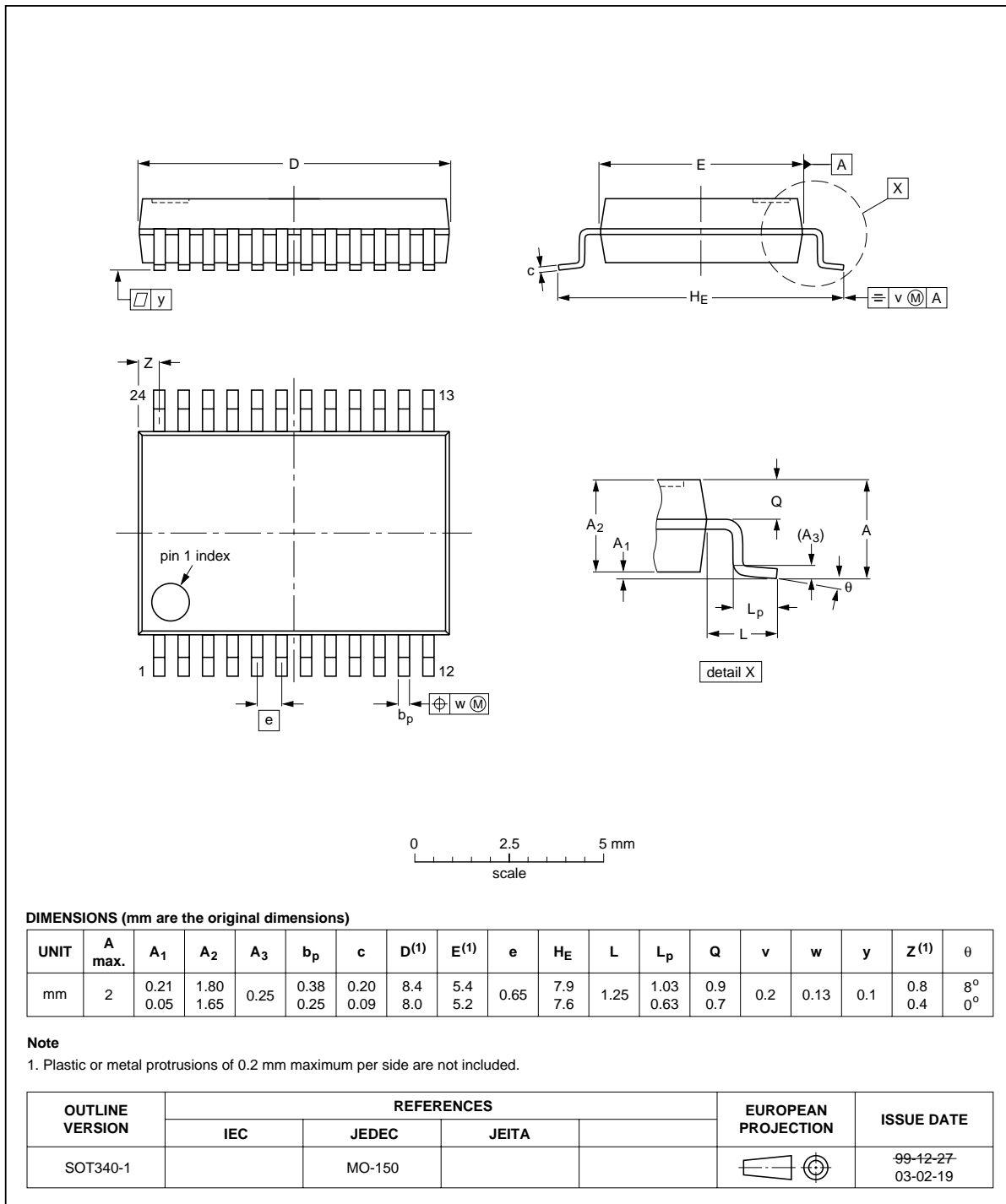

Fig 28. Package outline SOT340-1 (SSOP24)

HVQFN32: plastic thermal enhanced very thin quad flat package; no leads;  
32 terminals; body 5 x 5 x 0.85 mm

SOT617-3

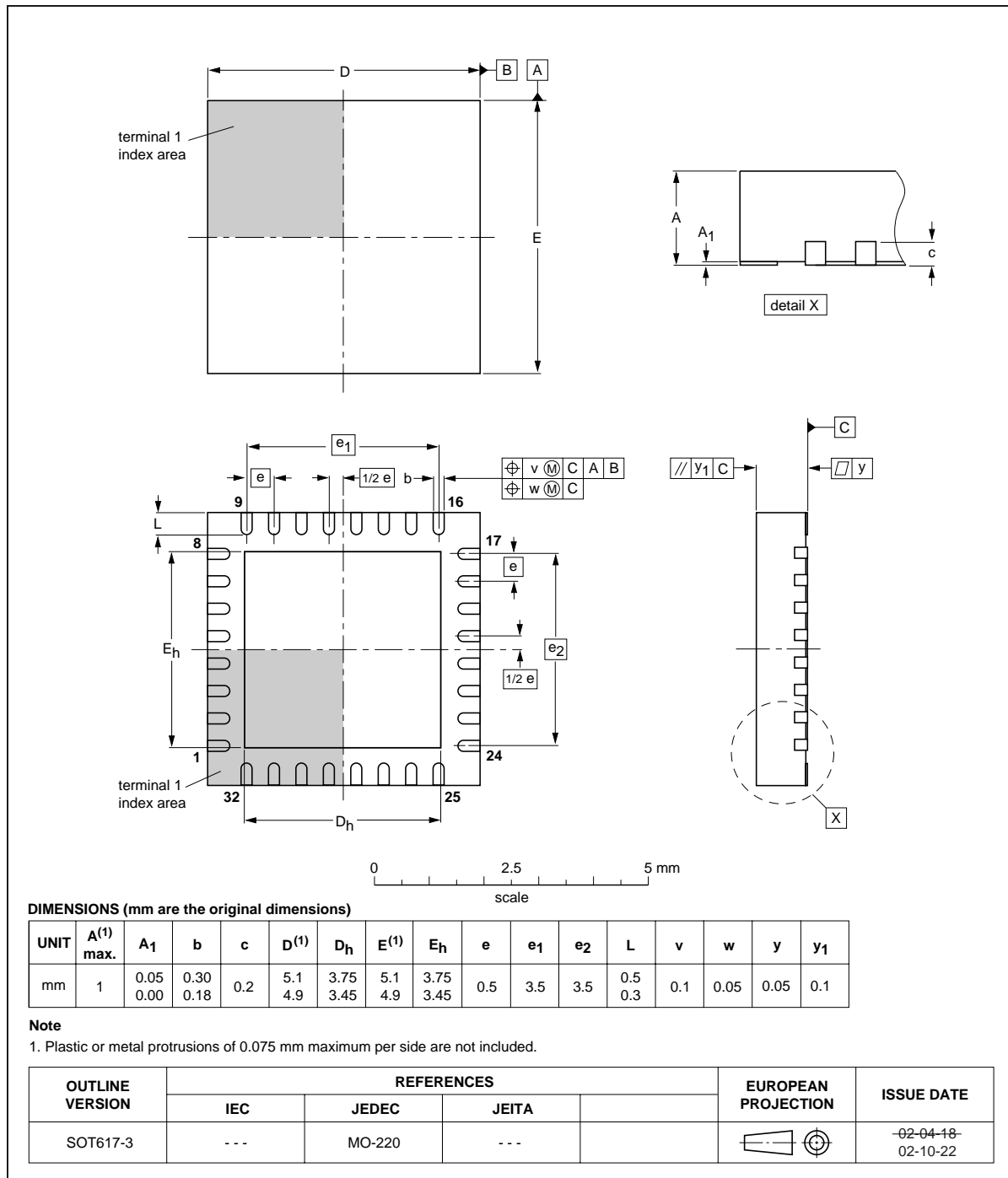

Fig 29. Package outline SOT617-3 (HVQFN32)

## 16. Soldering of SMD packages

This text provides a very brief insight into a complex technology. A more in-depth account of soldering ICs can be found in Application Note *AN10365 "Surface mount reflow soldering description"*.

### 16.1 Introduction to soldering

Soldering is one of the most common methods through which packages are attached to Printed Circuit Boards (PCBs), to form electrical circuits. The soldered joint provides both the mechanical and the electrical connection. There is no single soldering method that is ideal for all IC packages. Wave soldering is often preferred when through-hole and Surface Mount Devices (SMDs) are mixed on one printed wiring board; however, it is not suitable for fine pitch SMDs. Reflow soldering is ideal for the small pitches and high densities that come with increased miniaturization.

### 16.2 Wave and reflow soldering

Wave soldering is a joining technology in which the joints are made by solder coming from a standing wave of liquid solder. The wave soldering process is suitable for the following:

- Through-hole components
- Leaded or leadless SMDs, which are glued to the surface of the printed circuit board

Not all SMDs can be wave soldered. Packages with solder balls, and some leadless packages which have solder lands underneath the body, cannot be wave soldered. Also, leaded SMDs with leads having a pitch smaller than ~0.6 mm cannot be wave soldered, due to an increased probability of bridging.

The reflow soldering process involves applying solder paste to a board, followed by component placement and exposure to a temperature profile. Leaded packages, packages with solder balls, and leadless packages are all reflow solderable.

Key characteristics in both wave and reflow soldering are:

- Board specifications, including the board finish, solder masks and vias
- Package footprints, including solder thieves and orientation
- The moisture sensitivity level of the packages
- Package placement
- Inspection and repair
- Lead-free soldering versus SnPb soldering

### 16.3 Wave soldering

Key characteristics in wave soldering are:

- Process issues, such as application of adhesive and flux, clinching of leads, board transport, the solder wave parameters, and the time during which components are exposed to the wave
- Solder bath specifications, including temperature and impurities

## 16.4 Reflow soldering

Key characteristics in reflow soldering are:

- Lead-free versus SnPb soldering; note that a lead-free reflow process usually leads to higher minimum peak temperatures (see [Figure 30](#)) than a SnPb process, thus reducing the process window
- Solder paste printing issues including smearing, release, and adjusting the process window for a mix of large and small components on one board
- Reflow temperature profile; this profile includes preheat, reflow (in which the board is heated to the peak temperature) and cooling down. It is imperative that the peak temperature is high enough for the solder to make reliable solder joints (a solder paste characteristic). In addition, the peak temperature must be low enough that the packages and/or boards are not damaged. The peak temperature of the package depends on package thickness and volume and is classified in accordance with [Table 24](#) and [25](#)

**Table 24. SnPb eutectic process (from J-STD-020C)**

Package thickness (mm)	Package reflow temperature (°C)	
	Volume (mm <sup>3</sup> )	
	< 350	≥ 350
< 2.5	235	220
≥ 2.5	220	220

**Table 25. Lead-free process (from J-STD-020C)**

Package thickness (mm)	Package reflow temperature (°C)		
	Volume (mm <sup>3</sup> )		
	< 350	350 to 2000	> 2000
< 1.6	260	260	260
1.6 to 2.5	260	250	245
> 2.5	250	245	245

Moisture sensitivity precautions, as indicated on the packing, must be respected at all times.

Studies have shown that small packages reach higher temperatures during reflow soldering, see [Figure 30](#).

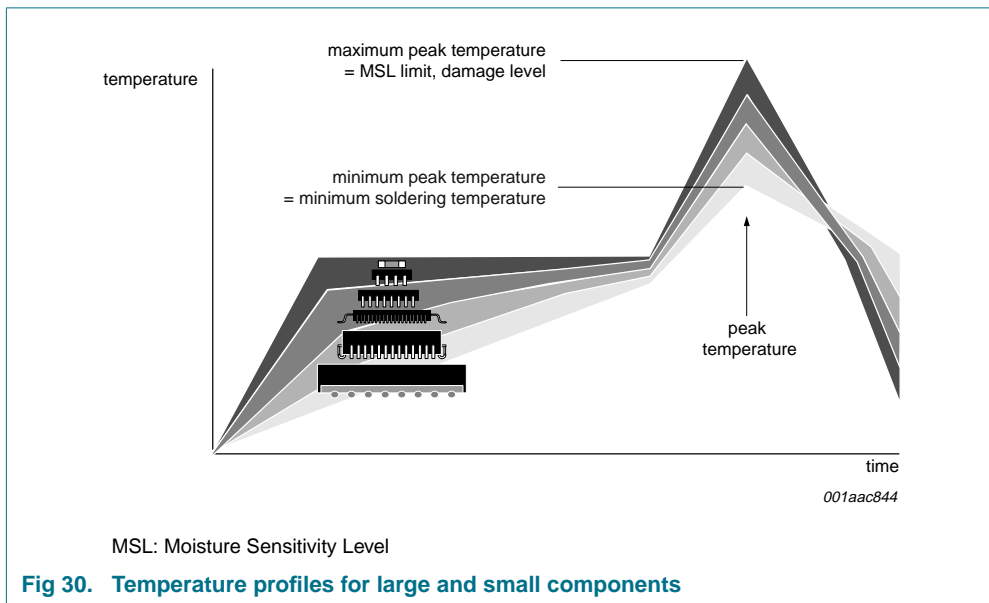

For further information on temperature profiles, refer to Application Note AN10365 “Surface mount reflow soldering description”.

## 17. Abbreviations

**Table 26. Abbreviations**

Acronym	Description
AF	Audio Frequency
AFC	Automatic Frequency Control
AGC	Automatic Gain Control
DSB	Double SideBand
FPLL	Frequency Phase-Locked Loop
IF	Intermediate Frequency
MAD	Module Address
NTSC	National Television Standards Committee
PAL	Phase Alternating Line
PC	Personal Computer
PC	Picture Carrier
PLL	Phase-Locked Loop
QSS	Quasi Split Sound
SAD	SubADdress
SAW	Surface Acoustic Wave
SC	Sound Carrier
SECAM	SEquentiel Couleur Avec Memoire
SIF	Sound Intermediate Frequency
STB	Set-Top Box

Table 26. Abbreviations ...continued

Acronym	Description
TOP	TakeOver Point
VCO	Voltage-Controlled Oscillator
VIF	Vision Intermediate Frequency
VITS	Vertical Interval Test Signal
VTR	Video Tape Recorder

## 18. Revision history

Table 27. Revision history

Document ID	Release date	Data sheet status	Change notice	Supersedes
TDA9885_TDA9886_3	20081216	Product data sheet	-	TDA9885_TDA9886_2
Modifications:		<ul style="list-style-type: none"> <li>The format of this data sheet has been redesigned to comply with the new identity guidelines of NXP Semiconductors.</li> <li>Legal texts have been adapted to the new company name where appropriate.</li> <li><a href="#">Section 5</a>: added V5 versions</li> <li><a href="#">Figure 25</a>: update on application diagram</li> </ul>		
TDA9885_TDA9886_2	20031002	Product specification	-	TDA9885_TDA9886_1
TDA9885_TDA9886_1	20020305	Product specification	-	-

## 19. Legal information

### 19.1 Data sheet status

Document status <sup>[1][2]</sup>	Product status <sup>[3]</sup>	Definition
Objective [short] data sheet	Development	This document contains data from the objective specification for product development.
Preliminary [short] data sheet	Qualification	This document contains data from the preliminary specification.
Product [short] data sheet	Production	This document contains the product specification.

[1] Please consult the most recently issued document before initiating or completing a design.

[2] The term 'short data sheet' is explained in section "Definitions".

[3] The product status of device(s) described in this document may have changed since this document was published and may differ in case of multiple devices. The latest product status information is available on the Internet at URL <http://www.nxp.com>.

### 19.2 Definitions

**Draft** — The document is a draft version only. The content is still under internal review and subject to formal approval, which may result in modifications or additions. NXP Semiconductors does not give any representations or warranties as to the accuracy or completeness of information included herein and shall have no liability for the consequences of use of such information.

**Short data sheet** — A short data sheet is an extract from a full data sheet with the same product type number(s) and title. A short data sheet is intended for quick reference only and should not be relied upon to contain detailed and full information. For detailed and full information see the relevant full data sheet, which is available on request via the local NXP Semiconductors sales office. In case of any inconsistency or conflict with the short data sheet, the full data sheet shall prevail.

### 19.3 Disclaimers

**General** — Information in this document is believed to be accurate and reliable. However, NXP Semiconductors does not give any representations or warranties, expressed or implied, as to the accuracy or completeness of such information and shall have no liability for the consequences of use of such information.

**Right to make changes** — NXP Semiconductors reserves the right to make changes to information published in this document, including without limitation specifications and product descriptions, at any time and without notice. This document supersedes and replaces all information supplied prior to the publication hereof.

**Suitability for use** — NXP Semiconductors products are not designed, authorized or warranted to be suitable for use in medical, military, aircraft, space or life support equipment, nor in applications where failure or malfunction of an NXP Semiconductors product can reasonably be expected to result in personal injury, death or severe property or environmental

damage. NXP Semiconductors accepts no liability for inclusion and/or use of NXP Semiconductors products in such equipment or applications and therefore such inclusion and/or use is at the customer's own risk.

**Applications** — Applications that are described herein for any of these products are for illustrative purposes only. NXP Semiconductors makes no representation or warranty that such applications will be suitable for the specified use without further testing or modification.

**Limiting values** — Stress above one or more limiting values (as defined in the Absolute Maximum Ratings System of IEC 60134) may cause permanent damage to the device. Limiting values are stress ratings only and operation of the device at these or any other conditions above those given in the Characteristics sections of this document is not implied. Exposure to limiting values for extended periods may affect device reliability.

**Terms and conditions of sale** — NXP Semiconductors products are sold subject to the general terms and conditions of commercial sale, as published at <http://www.nxp.com/profile/terms>, including those pertaining to warranty, intellectual property rights infringement and limitation of liability, unless explicitly otherwise agreed to in writing by NXP Semiconductors. In case of any inconsistency or conflict between information in this document and such terms and conditions, the latter will prevail.

**No offer to sell or license** — Nothing in this document may be interpreted or construed as an offer to sell products that is open for acceptance or the grant, conveyance or implication of any license under any copyrights, patents or other industrial or intellectual property rights.

**Quick reference data** — The Quick reference data is an extract of the product data given in the Limiting values and Characteristics sections of this document, and as such is not complete, exhaustive or legally binding.

### 19.4 Trademarks

Notice: All referenced brands, product names, service names and trademarks are the property of their respective owners.

I<sup>2</sup>C-bus — logo is a trademark of NXP B.V.

## 20. Contact information

For more information, please visit: <http://www.nxp.com>

For sales office addresses, please send an email to: [salesaddresses@nxp.com](mailto:salesaddresses@nxp.com)

**21. Contents**

<b>1</b>	<b>General description</b> . . . . .	<b>1</b>	<b>16.4</b>	Reflow soldering . . . . .	<b>52</b>
<b>2</b>	<b>Features</b> . . . . .	<b>1</b>	<b>17</b>	<b>Abbreviations</b> . . . . .	<b>53</b>
<b>3</b>	<b>Applications</b> . . . . .	<b>2</b>	<b>18</b>	<b>Revision history</b> . . . . .	<b>54</b>
<b>4</b>	<b>Quick reference data</b> . . . . .	<b>2</b>	<b>19</b>	<b>Legal information</b> . . . . .	<b>55</b>
<b>5</b>	<b>Ordering information</b> . . . . .	<b>4</b>	19.1	Data sheet status . . . . .	55
<b>6</b>	<b>Block diagram</b> . . . . .	<b>5</b>	19.2	Definitions . . . . .	55
<b>7</b>	<b>Pinning information</b> . . . . .	<b>6</b>	19.3	Disclaimers . . . . .	55
7.1	Pinning . . . . .	6	19.4	Trademarks . . . . .	55
7.2	Pin description . . . . .	7	<b>20</b>	<b>Contact information</b> . . . . .	<b>55</b>
<b>8</b>	<b>Functional description</b> . . . . .	<b>8</b>	<b>21</b>	<b>Contents</b> . . . . .	<b>56</b>
8.1	VIF amplifier . . . . .	8			
8.2	Tuner AGC and VIF AGC . . . . .	8			
8.3	VIF-AGC detector . . . . .	9			
8.4	FPLL detector . . . . .	9			
8.5	VCO and divider . . . . .	9			
8.6	AFC and digital acquisition help . . . . .	10			
8.7	Video demodulator and amplifier . . . . .	10			
8.8	Sound carrier trap . . . . .	11			
8.9	SIF amplifier . . . . .	11			
8.10	SIF-AGC detector . . . . .	11			
8.11	Single reference QSS mixer . . . . .	11			
8.12	AM demodulator . . . . .	12			
8.13	FM demodulator and acquisition help . . . . .	12			
8.14	Audio amplifier and mute time constant . . . . .	12			
8.15	Internal voltage stabilizer . . . . .	13			
8.16	I <sup>2</sup> C-bus transceiver and MAD . . . . .	13			
<b>9</b>	<b>I<sup>2</sup>C-bus control</b> . . . . .	<b>14</b>			
9.1	Read format . . . . .	14			
9.1.1	Slave address . . . . .	14			
9.1.2	Data byte . . . . .	15			
9.2	Write format . . . . .	16			
9.2.1	Subaddress (A data) . . . . .	17			
9.2.2	Data byte for switching mode (B data) . . . . .	17			
9.2.3	Data byte for adjust mode (C data) . . . . .	18			
9.2.4	Data byte for data mode (E data) . . . . .	19			
<b>10</b>	<b>Limiting values</b> . . . . .	<b>21</b>			
<b>11</b>	<b>Thermal characteristics</b> . . . . .	<b>21</b>			
<b>12</b>	<b>Characteristics</b> . . . . .	<b>22</b>			
<b>13</b>	<b>Application information</b> . . . . .	<b>45</b>			
<b>14</b>	<b>Test information</b> . . . . .	<b>46</b>			
<b>15</b>	<b>Package outline</b> . . . . .	<b>48</b>			
<b>16</b>	<b>Soldering of SMD packages</b> . . . . .	<b>51</b>			
16.1	Introduction to soldering . . . . .	51			
16.2	Wave and reflow soldering . . . . .	51			
16.3	Wave soldering . . . . .	51			

Please be aware that important notices concerning this document and the product(s) described herein, have been included in section 'Legal information'.



© NXP B.V. 2008. All rights reserved.  
 For more information, please visit: <http://www.nxp.com>  
 For sales office addresses, please send an email to: [salesaddresses@nxp.com](mailto:salesaddresses@nxp.com)  
 Date of release: 16 December 2008  
 Document identifier: TDA9885\_TDA9886\_3