



# 1.8V, 2.9 $\mu$ A, 90kHz, Rail-to-Rail I/O OPERATIONAL AMPLIFIERS

## FEATURES

- **LOW NOISE:** 2.8 $\mu$ V<sub>PP</sub>
- **microPower:** 5.5 $\mu$ A (max)
- **LOW OFFSET VOLTAGE:** 1.5mV (max)
- **DC PRECISION:**
  - CMRR: 100dB
  - PSRR: 2 $\mu$ V/V
  - A<sub>OL</sub>: 120dB
- **WIDE SUPPLY VOLTAGE RANGE:** 1.8V to 5.5V
- **microSize PACKAGES**

## APPLICATIONS

- BATTERY-POWERED INSTRUMENTS
- PORTABLE DEVICES
- MEDICAL INSTRUMENTS
- HANDHELD TEST EQUIPMENT

## DESCRIPTION

The OPA379 family of micropower, low-voltage operational amplifiers is designed for battery-powered applications. These amplifiers operate on a supply voltage as low as 1.8V. High-performance, single-supply operation with rail-to-rail capability makes the OPA379 family useful for a wide range of applications.

In addition to *microSize* packages, the OPA379 family of op amps features impressive bandwidth (90kHz), low bias current (25pA), and low noise (80nV/ $\sqrt{\text{Hz}}$ ) relative to the very low quiescent current (5.5 $\mu$ A max).

The OPA379 (single) is available in SC70-5, SOT23-5, and SO-8 packages. The OPA2379 (dual) comes in SOT23-8 and SO-8 packages. The OPA4379 (quad) is offered in a TSSOP-14 package. All versions are specified from –40°C to +125°C.

## OPAx379 RELATED PRODUCTS

FEATURES	PRODUCT
1 $\mu$ A, 70kHz, 2mV V <sub>OS</sub> , 1.8V to 5.5V Supply	OPAx349
1 $\mu$ A, 5.5kHz, 390 $\mu$ V V <sub>OS</sub> , 2.5V to 16V Supply	TLV240x
1 $\mu$ A, 5.5kHz, 0.6mV V <sub>OS</sub> , 2.5V to 12V Supply	TLV224x
7 $\mu$ A, 160kHz, 0.5mV V <sub>OS</sub> , 2.7V to 16V Supply	TLV27Lx
7 $\mu$ A, 160kHz, 0.5mV V <sub>OS</sub> , 2.7V to 16V Supply	TLV238x
20 $\mu$ A, 350kHz, 2mV V <sub>OS</sub> , 2.3V to 5.5V Supply	OPAx347
20 $\mu$ A, 500kHz, 550 $\mu$ V V <sub>OS</sub> , 1.8V to 3.6V Supply	TLV276x
45 $\mu$ A, 1MHz, 1mV V <sub>OS</sub> , 2.1V to 5.5V Supply	OPAx348



Please be aware that an important notice concerning availability, standard warranty, and use in critical applications of Texas Instruments semiconductor products and disclaimers thereto appears at the end of this data sheet.

All trademarks are the property of their respective owners.

**ABSOLUTE MAXIMUM RATINGS(1)**

Supply Voltage	+7V
Signal Input Terminals, Voltage(2)	-0.5V to (V+) + 0.5V
Current(2)	±10mA
Output Short-Circuit(3)	Continuous
Operating Temperature	-40°C to +125°C
Storage Temperature	-65°C to +150°C
Junction Temperature	+150°C
ESD Rating	
Human Body Model	2000V
Charged Device Model	1000V

- (1) Stresses above these ratings may cause permanent damage. Exposure to absolute maximum conditions for extended periods may degrade device reliability. These are stress ratings only, and functional operation of the device at these or any other conditions beyond those specified is not supported.
- (2) Input terminals are diode-clamped to the power-supply rails. Input signals that can swing more than 0.5V beyond the supply rails should be current-limited to 10mA or less.
- (3) Short-circuit to ground, one amplifier per package.



This integrated circuit can be damaged by ESD. Texas Instruments recommends that all integrated circuits be handled with appropriate precautions. Failure to observe proper handling and installation procedures can cause damage.

ESD damage can range from subtle performance degradation to complete device failure. Precision integrated circuits may be more susceptible to damage because very small parametric changes could cause the device not to meet its published specifications.

**ORDERING INFORMATION(1)**

PRODUCT	PACKAGE-LEAD	PACKAGE DESIGNATOR	PACKAGE MARKING
OPA379(2)	SC70-5	DCK	AYR
OPA379(2)	SOT23-5	DBV	AYQ
OPA379	SO-8	D	OPA379
OPA2379(2)	SOT23-8	DCN	B61
OPA2379	SO-8	D	OPA2379
OPA4379(2)	TSSOP-14	PW	OPA4379

- (1) For the most current package and ordering information, see the Package Option Addendum at the end of this document, or see the TI web site at www.ti.com.
- (2) Available Q1, 2006.

**PIN CONFIGURATIONS**

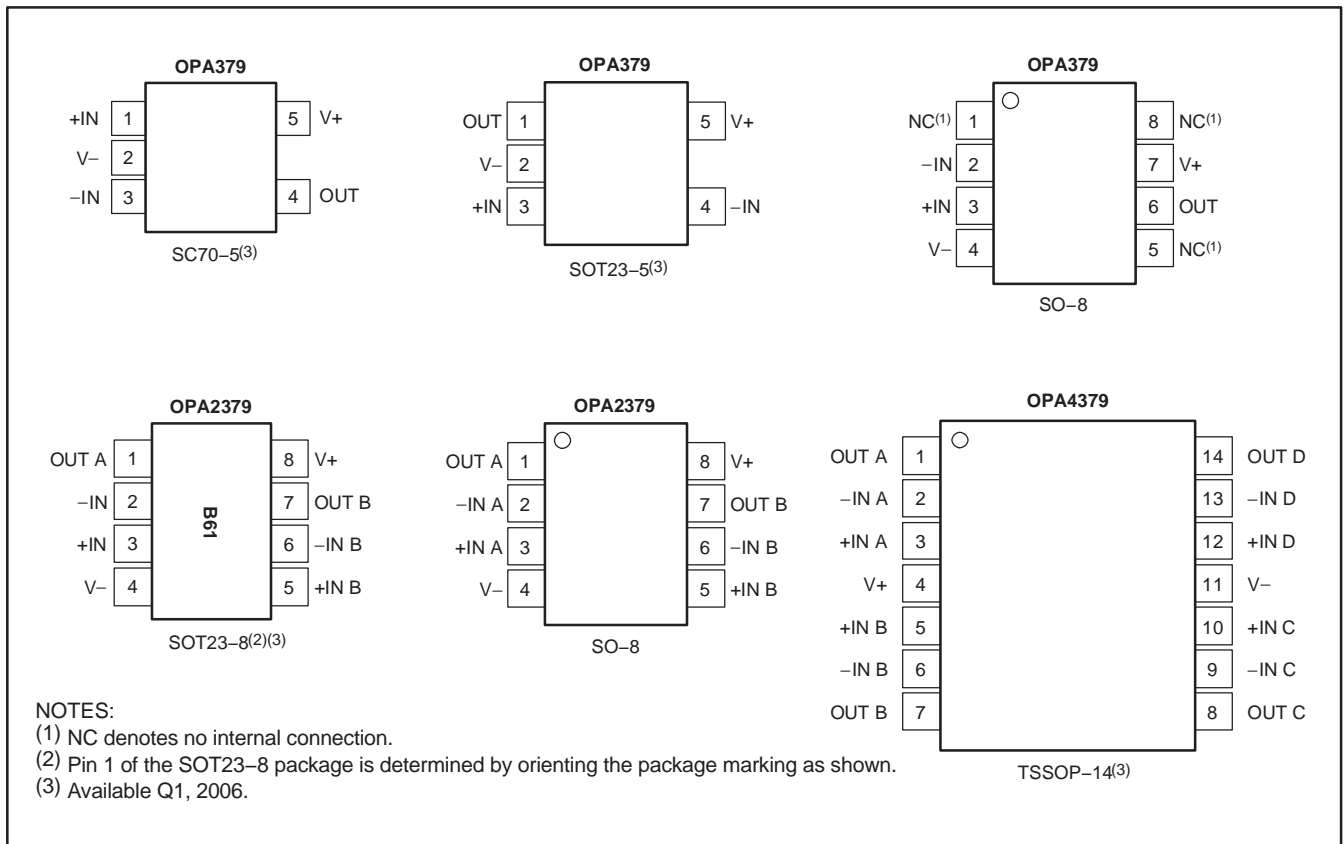

## ELECTRICAL CHARACTERISTICS: $V_S = +1.8V$ TO $+5.5V$

**Boldface** limits apply over the specified temperature range indicated.

At  $T_A = +25^\circ\text{C}$ ,  $R_L = 25\text{k}\Omega$  connected to  $V_S/2$ , and  $V_{CM} < (V+) - 1V$ , unless otherwise noted.

PARAMETER	CONDITIONS	OPA379, OPA2379, OPA4379			UNIT
		MIN	TYP	MAX	
<b>OFFSET VOLTAGE</b>					
Initial Offset Voltage	$V_{OS}$ $V_S = 5V$		0.4	1.5	mV
Over $-40^\circ\text{C}$ to $+125^\circ\text{C}$				<b>2</b>	<b>mV</b>
Drift, $-40^\circ\text{C}$ to $+85^\circ\text{C}$	$dV_{OS}/dT$		<b>1.5</b>		$\mu\text{V}/^\circ\text{C}$
$-40^\circ\text{C}$ to $+125^\circ\text{C}$			<b>2.7</b>		$\mu\text{V}/^\circ\text{C}$
vs Power Supply	PSRR		2	10	$\mu\text{V}/V$
Over $-40^\circ\text{C}$ to $+125^\circ\text{C}$				<b>20</b>	$\mu\text{V}/V$
<b>INPUT VOLTAGE RANGE</b>					
Common-Mode Voltage Range	$V_{CM}$ $(V-) < V_{CM} < (V+) - 1V$		$(V-) - 0.1$ to $(V+) + 0.1$		V
Common-Mode Rejection Ratio <sup>(1)</sup>	CMRR	90	100		dB
Over $-40^\circ\text{C}$ to $+85^\circ\text{C}$		<b>80</b>			<b>dB</b>
Over $-40^\circ\text{C}$ to $+125^\circ\text{C}$		<b>62</b>			<b>dB</b>
<b>INPUT BIAS CURRENT</b>					
Input Bias Current	$I_B$ $V_S = 5V, V_{CM} < V_S/2$		$\pm 5$	$\pm 50$	pA
Input Offset Current	$I_{OS}$ $V_S = 5V$		$\pm 5$	$\pm 50$	pA
<b>INPUT IMPEDANCE</b>					
Differential			$10^{13} \parallel 3$		$\Omega \parallel \text{pF}$
Common-Mode			$10^{13} \parallel 6$		$\Omega \parallel \text{pF}$
<b>NOISE</b>					
Input Voltage Noise, $f = 0.1\text{Hz}$ to $10\text{Hz}$			2.8		$\mu\text{V}_{pp}$
Input Voltage Noise Density, $f = 1\text{kHz}$	$e_n$		80		$\text{nV}/\sqrt{\text{Hz}}$
Input Current Noise Density, $f = 1\text{kHz}$	$i_n$		1		$\text{fA}/\sqrt{\text{Hz}}$
<b>OPEN-LOOP GAIN</b>					
Open-Loop Voltage Gain	$A_{OL}$ $V_S = 5V, R_L = 25\text{k}\Omega, 100\text{mV} < V_O < (V+) - 100\text{mV}$	100	120		dB
Over $-40^\circ\text{C}$ to $+125^\circ\text{C}$		<b>92</b>			<b>dB</b>
	$V_S = 5V, R_L = 25\text{k}\Omega, 100\text{mV} < V_O < (V+) - 100\text{mV}$	100	120		dB
Over $-40^\circ\text{C}$ to $+125^\circ\text{C}$		<b>92</b>			<b>dB</b>
	$V_S = 5V, R_L = 5\text{k}\Omega, 500\text{mV} < V_O < (V+) - 500\text{mV}$	100	120		dB
Over $-40^\circ\text{C}$ to $+125^\circ\text{C}$		<b>92</b>			<b>dB</b>
	$V_S = 5V, R_L = 5\text{k}\Omega, 500\text{mV} < V_O < (V+) - 500\text{mV}$	100	120		dB
Over $-40^\circ\text{C}$ to $+125^\circ\text{C}$		<b>92</b>			<b>dB</b>
<b>OUTPUT</b>					
Voltage Output Swing from Rail					
Over $-40^\circ\text{C}$ to $+125^\circ\text{C}$			5	10	mV
	$R_L = 25\text{k}\Omega$			<b>15</b>	<b>mV</b>
	$R_L = 25\text{k}\Omega$			<b>15</b>	<b>mV</b>
	$R_L = 5\text{k}\Omega$		25	50	mV
Over $-40^\circ\text{C}$ to $+125^\circ\text{C}$				<b>75</b>	<b>mV</b>
Short-Circuit Current	$I_{SC}$		$\pm 5$		mA
Capacitive Load Drive	$C_{LOAD}$		See Typical Characteristics Curve		
Closed-Loop Output Impedance	$R_{OUT}$	$G = 1, f = 1\text{kHz}, I_O = 0$	10		$\Omega$
Open-Loop Output Impedance	$R_O$	$f = 100\text{kHz}, I_O = 0$	28		k $\Omega$
<b>FREQUENCY RESPONSE</b>					
Gain Bandwidth Product	GBW	$C_{LOAD} = 30\text{pF}$	90		kHz
Slew Rate	SR	$G = +1$	0.03		V/ $\mu\text{s}$
Overload Recovery Time		$V_{IN} \cdot \text{GAIN} > V_S$	25		$\mu\text{s}$
Turn-On Time	$t_{ON}$		1		ms
<b>POWER SUPPLY</b>					
Specified/Operating Voltage Range	$V_S$		1.8	5.5	V
Quiescent Current per Amplifier	$I_Q$	$V_S = 5.5V, I_O = 0$	2.9	5.5	$\mu\text{A}$
Over $-40^\circ\text{C}$ to $+125^\circ\text{C}$				<b>10</b>	<b><math>\mu\text{A}</math></b>
<b>TEMPERATURE</b>					
Specified/Operating Range			-40	+125	$^\circ\text{C}$
Storage Range			-65	+150	$^\circ\text{C}$
Thermal Resistance	$\theta_{JA}$				
SC70-5			250		$^\circ\text{C}/W$
SOT23-5			200		$^\circ\text{C}/W$
SOT23-8, TSSOP-14, SO-8			150		$^\circ\text{C}/W$

(1) See Typical Characteristic, *Common-Mode Rejection Ratio vs Frequency*.

## TYPICAL CHARACTERISTICS

At  $T_A = +25^\circ\text{C}$ ,  $V_S = 5\text{V}$ ,  $R_L = 25\text{k}\Omega$  connected to  $V_S/2$ , unless otherwise noted.

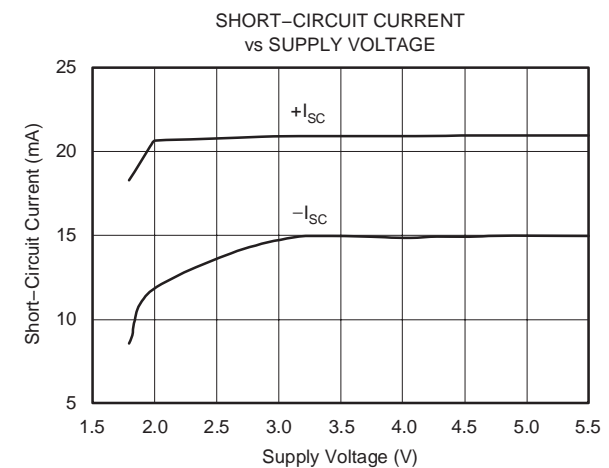
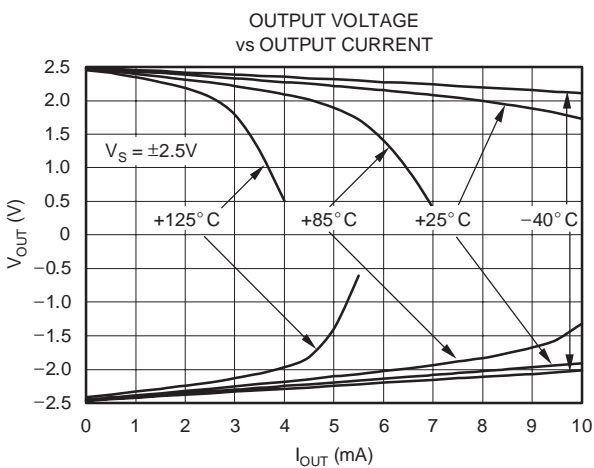
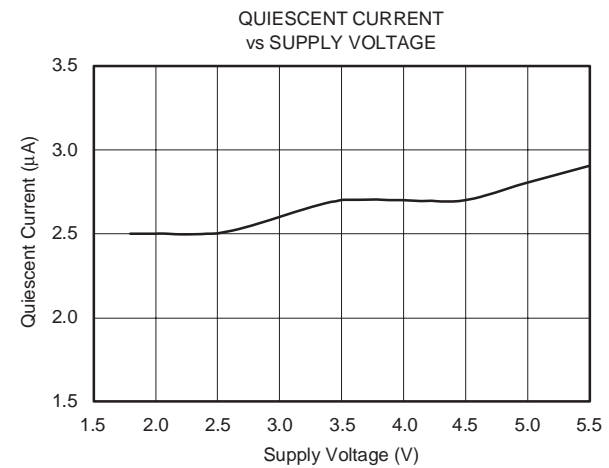
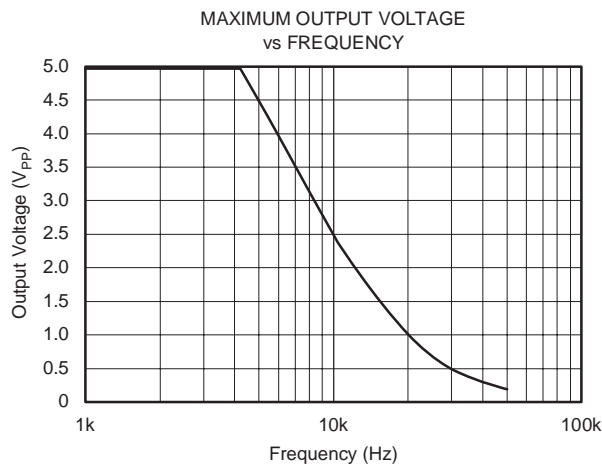
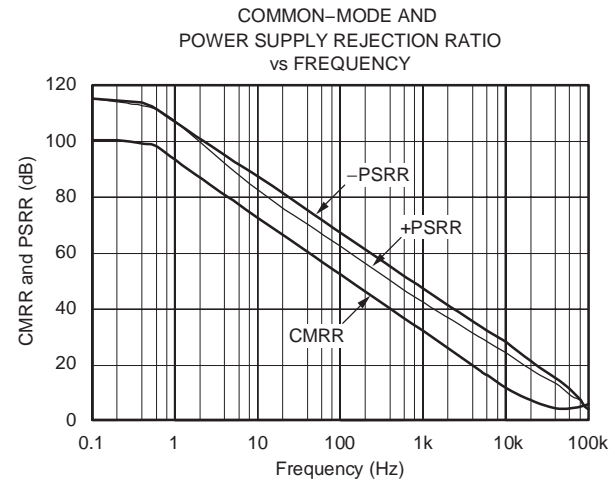
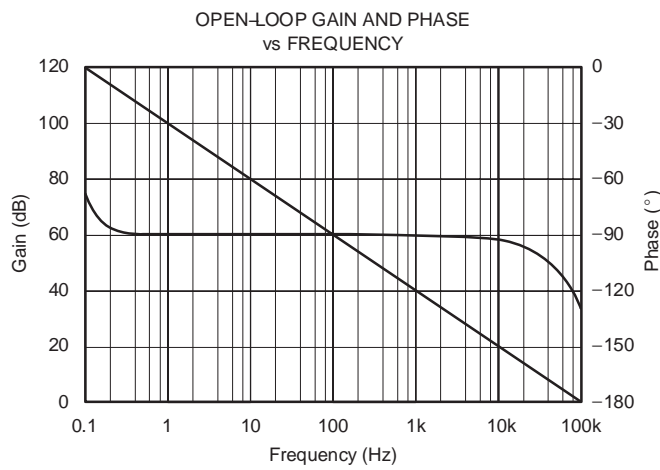

**TYPICAL CHARACTERISTICS (continued)**

At  $T_A = +25^\circ\text{C}$ ,  $V_S = 5\text{V}$ ,  $R_L = 25\text{k}\Omega$  connected to  $V_S/2$ , unless otherwise noted.

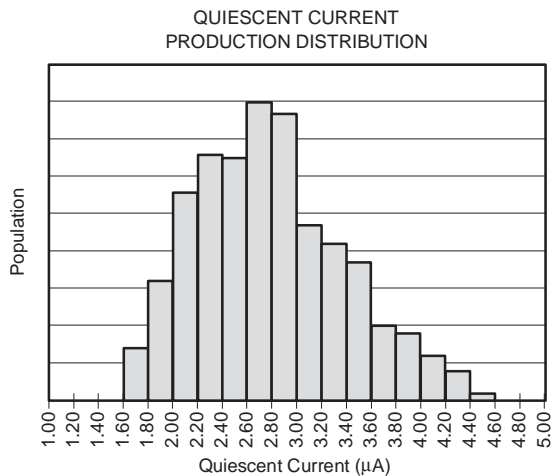
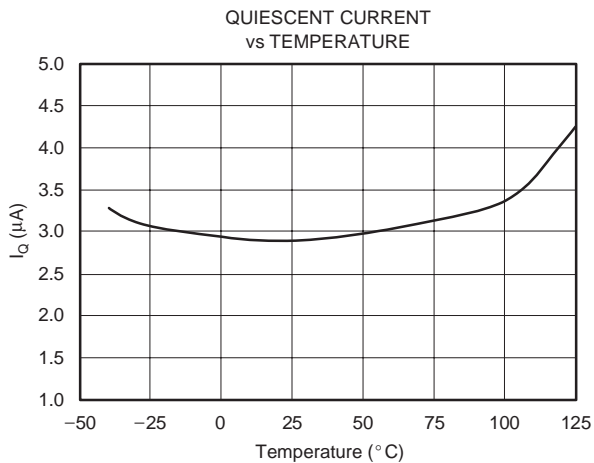
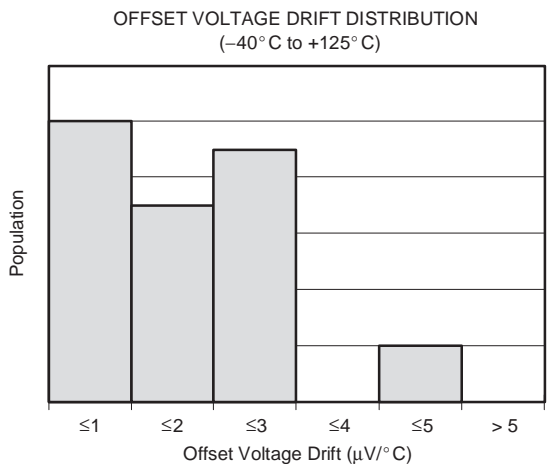
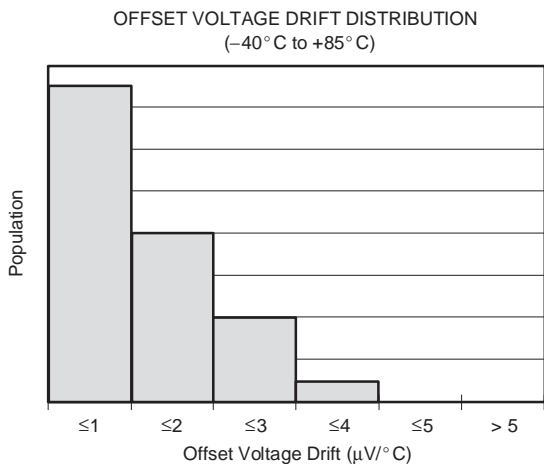
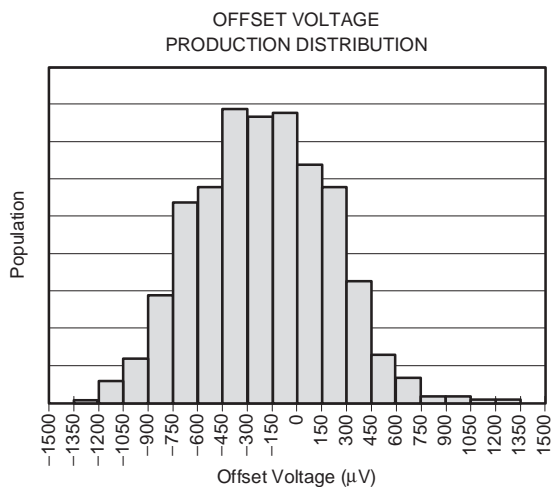
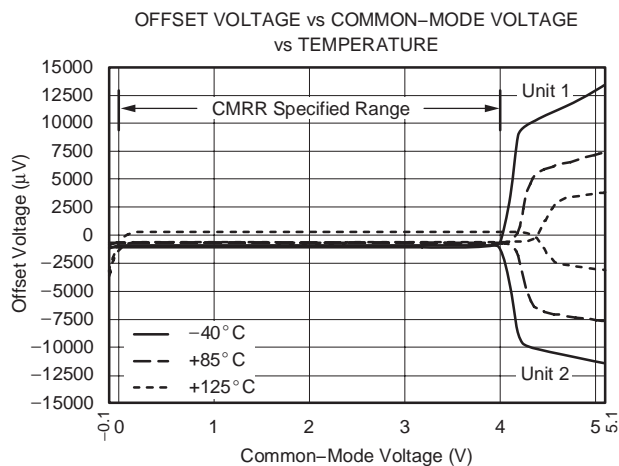

**TYPICAL CHARACTERISTICS (continued)**

At  $T_A = +25^\circ\text{C}$ ,  $V_S = 5\text{V}$ ,  $R_L = 25\text{k}\Omega$  connected to  $V_S/2$ , unless otherwise noted.

INPUT BIAS CURRENT  
 vs TEMPERATURE

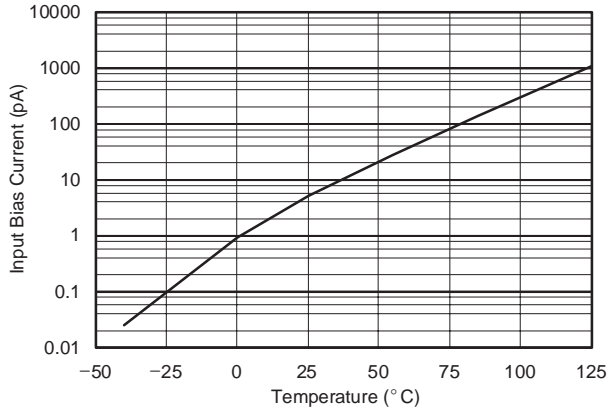

0.1Hz TO 10Hz NOISE

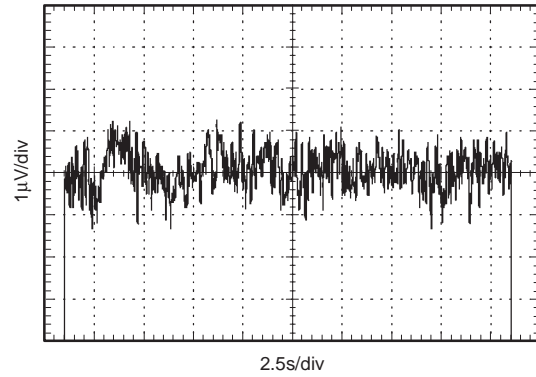

NOISE vs FREQUENCY

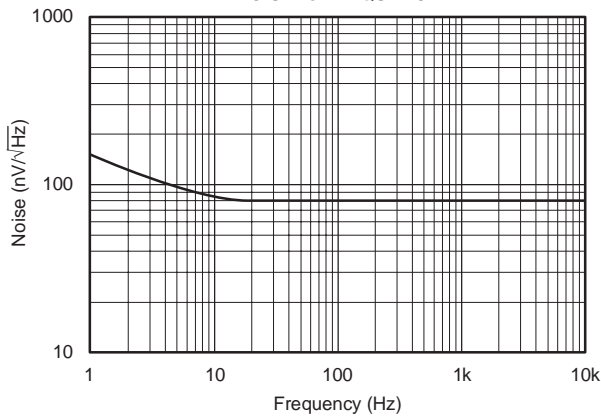

SMALL-SIGNAL OVERSHOOT  
 vs CAPACITIVE LOAD

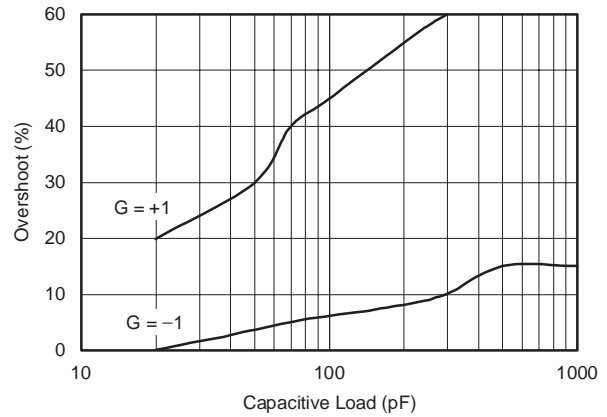

SMALL-SIGNAL STEP RESPONSE

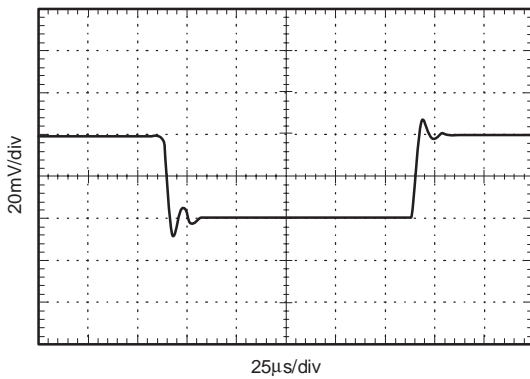

LARGE-SIGNAL STEP RESPONSE

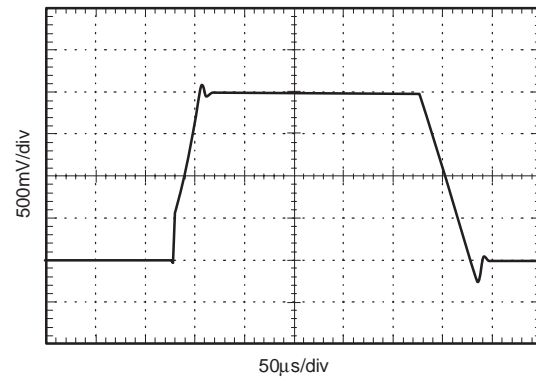

## APPLICATION INFORMATION

The OPA379 family of operational amplifiers minimizes power consumption without compromising bandwidth or noise. Power-supply rejection ratio (PSRR), common-mode rejection ratio (CMRR), and open-loop gain ( $A_{OL}$ ) typical values are 100dB or better.

When designing for ultra-low power, choose system components carefully. To minimize current consumption, select large-value resistors. Any resistors will react with stray capacitance in the circuit and the input capacitance of the operational amplifier. These parasitic RC combinations can affect the stability of the overall system. A feedback capacitor may be required to assure stability and limit overshoot or gain peaking.

Good layout practice mandates the use of a 0.1 $\mu$ F bypass capacitor placed closely across the supply pins.

### OPERATING VOLTAGE

OPA379 series op amps are fully specified and tested from +1.8V to +5.5V. Parameters that vary significantly with supply voltage are shown in the Typical Characteristics curves.

### INPUT COMMON-MODE VOLTAGE RANGE

The input common-mode voltage range of the OPA379 family typically extends 100mV beyond each supply rail. This rail-to-rail input is achieved using a complementary input stage. CMRR is specified from the negative rail to 1V below the positive rail. Between  $(V+) - 1V$  and  $(V+) + 0.1V$ , the amplifier operates with higher offset voltage because of the transition region of the input stage. See the typical characteristic, *Offset Voltage vs Common-Mode Voltage*.

### PROTECTING INPUTS FROM OVER-VOLTAGE

Normally, input currents are 5pA. However, large inputs (greater than 500mV beyond the supply rails) can cause excessive current to flow in or out of the input pins. Therefore, as well as keeping the input voltage below the maximum rating, it is also important to limit the input current to less than 10mA. This limiting is easily accomplished with an input voltage resistor, as shown in Figure 1.

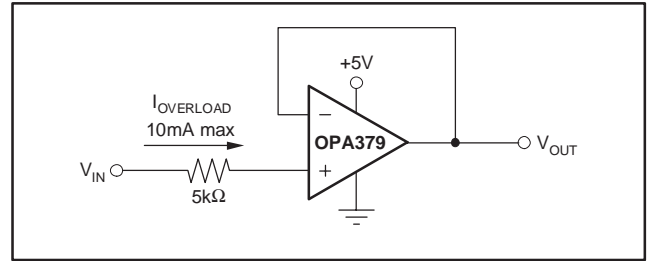

Figure 1. Input Current Protection for Voltages Exceeding the Supply Voltage

### NOISE

Although micropower amplifiers frequently have high wideband noise, the OPA379 series offer excellent noise performance. Resistors should be chosen carefully because the OPA379 has only 2.8 $\mu$ V<sub>PP</sub> of 0.1Hz to 10Hz noise, and 80nV/ $\sqrt{\text{Hz}}$  of wideband noise; otherwise, they can become the dominant source of noise.

### CAPACITIVE LOAD AND STABILITY

Follower configurations with load capacitance in excess of 30pF can produce extra overshoot (see typical characteristic, *Small-Signal Overshoot vs Capacitive Load*) and ringing in the output signal. Increasing the gain enhances the ability of the amplifier to drive greater capacitive loads. In unity-gain configurations, capacitive load drive can be improved by inserting a small (10 $\Omega$  to 20 $\Omega$ ) resistor,  $R_S$ , in series with the output, as shown in Figure 2. This resistor significantly reduces ringing while maintaining DC performance for purely capacitive loads. However, if there is a resistive load in parallel with the capacitive load, a voltage divider is created, introducing a Direct Current (DC) error at the output and slightly reducing the output swing. The error introduced is proportional to the ratio  $R_S/R_L$ , and is generally negligible.

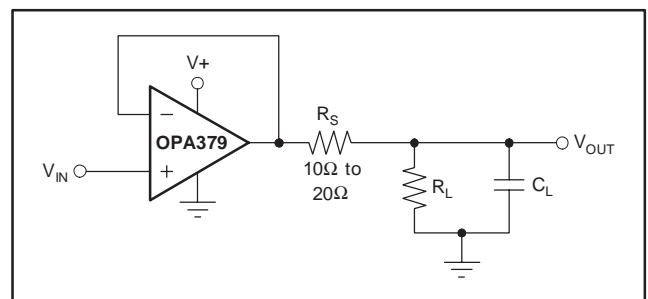

Figure 2. Series Resistor in Unity-Gain Buffer Configuration Improves Capacitive Load Drive

In unity-gain inverter configuration, phase margin can be reduced by the reaction between the capacitance at the op amp input and the gain setting resistors, thus degrading capacitive load drive. Best performance is achieved by using smaller valued resistors. However, when large valued resistors cannot be avoided, a small (4pF to 6pF) capacitor,  $C_{FB}$ , can be inserted in the feedback, as shown in Figure 3. This configuration significantly reduces overshoot by compensating the effect of capacitance,  $C_{IN}$ , which includes the amplifier input capacitance and PC board parasitic capacitance.

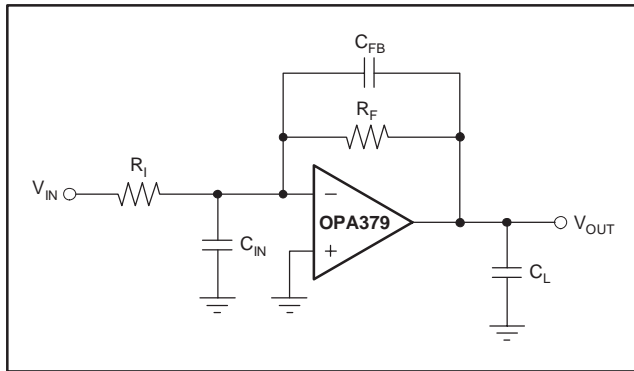

Figure 3. Improving Capacitive Load Drive

## BATTERY MONITORING

The low operating voltage and quiescent current of the OPA379 series make it an excellent choice for battery monitoring applications, as shown in Figure 4. In this circuit,  $V_{STATUS}$  will be high as long as the battery voltage remains above 2V. A low-power reference is used to set the trip point. Resistor values are selected as follows:

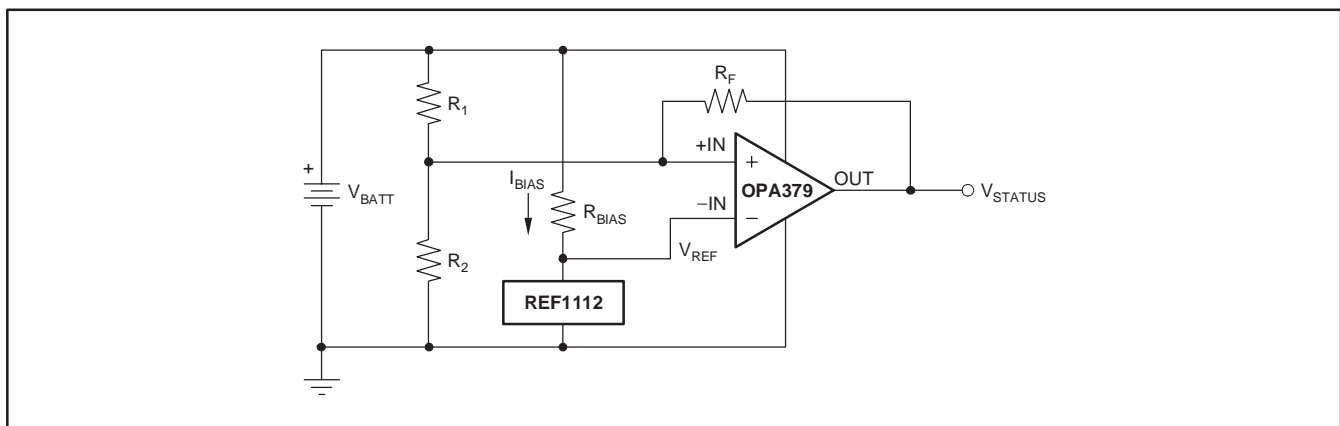

Figure 4. Battery Monitor

1. Selecting  $R_F$ : Select  $R_F$  such that the current through  $R_F$  is approximately 1000x larger than the maximum bias current over temperature:

$$\begin{aligned} R_F &= \frac{V_{REF}}{1000(I_{BMAX})} \\ &= \frac{1.2V}{1000(100pA)} \\ &= 12M\Omega \approx 10M\Omega \end{aligned} \quad (1)$$

2. Choose the hysteresis voltage,  $V_{HYST}$ . For battery-monitoring applications, 50mV is adequate.

3. Calculate  $R_1$  as follows:

$$R_1 = R_F \left( \frac{V_{HYST}}{V_{BATT}} \right) = 10M\Omega \left( \frac{50mV}{2.4V} \right) = 210k\Omega \quad (2)$$

4. Select a threshold voltage for  $V_{IN}$  rising ( $V_{THRS}$ ) = 2.0V

5. Calculate  $R_2$  as follows:

$$\begin{aligned} R_2 &= \frac{1}{\left[ \left( \frac{V_{THRS}}{V_{REF} \times R_1} \right) - \frac{1}{R_1} - \frac{1}{R_F} \right]} \\ &= \frac{1}{\left[ \left( \frac{2V}{1.2V \times 210k\Omega} \right) - \frac{1}{210k\Omega} - \frac{1}{10M\Omega} \right]} \\ &= 325k\Omega \end{aligned} \quad (3)$$

6. Calculate  $R_{BIAS}$ : The minimum supply voltage for this circuit will be 1.8V. The REF1112 has a current requirement of 1.2 $\mu$ A (max). Providing it 2 $\mu$ A of supply current assures proper operation. Therefore:

$$R_{BIAS} = \frac{V_{BATTMIN}}{I_{BIAS}} = \frac{1.8V}{2\mu A} = 0.9M\Omega \quad (4)$$



## LOW-SIDE CURRENT MONITOR

The micropower OPA379 is well suited for current monitoring circuits in applications such as a voltage regulator with fold-back current limiting, or a high-current power supply with crowbar protection. Figure 5 shows the OPA379 monitoring the current in a power-supply return path using a 0.1Ω shunt resistor. The NPN transistor, Q1 (2N2222 or equivalent) is used to generate equal voltages at the inverting and noninverting inputs. Therefore, the voltage drops across R<sub>1</sub> and R<sub>S</sub> are equal, and the current flowing through Q1 is directly proportional to the current flowing through R<sub>S</sub>. As the load current increases, the current through Q1 increases, the voltage drop across R<sub>2</sub> increases, and this decreases the output voltage, V<sub>OUT</sub>, as shown in Equation (5):

$$\begin{aligned} V_{OUT} &= \text{GND} - \left( \frac{R_2}{R_1} \times R_S \times I_L \right) \\ &= 0V - \left( \frac{2.49k\Omega}{100\Omega} \times 0.1\Omega \times I_L \right) \\ &= -2.49\Omega \times I_L \end{aligned} \quad (5)$$

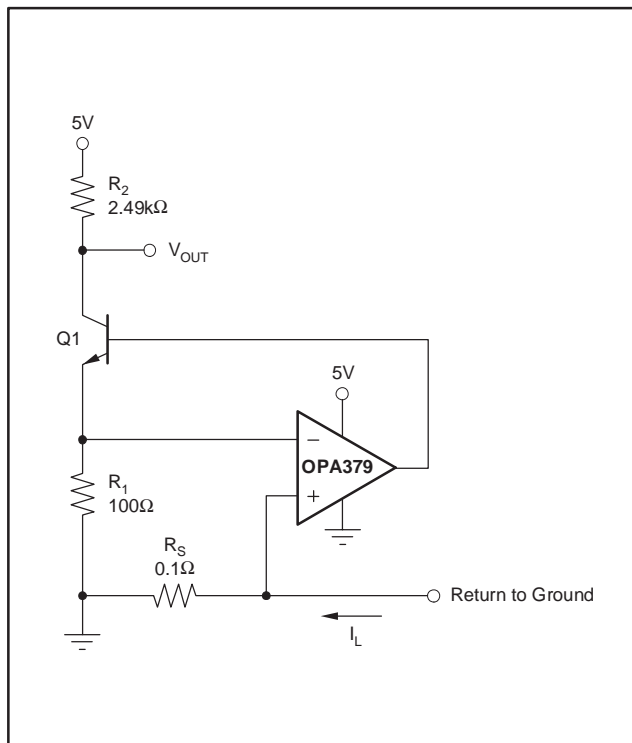

Figure 5. Low-Side Current Monitor

## WINDOW COMPARATOR

Figure 6 shows the OPA2379 used as a window comparator. The threshold limits are set by V<sub>H</sub> and V<sub>L</sub>, with V<sub>H</sub> > V<sub>L</sub>. When V<sub>IN</sub> < V<sub>H</sub>, the output of A1 will be low. When V<sub>IN</sub> > V<sub>L</sub>, the output of A2 will be low. Therefore, both op amp outputs will be at 0V as long as V<sub>IN</sub> is between V<sub>H</sub> and V<sub>L</sub>. This results in no current flowing through either diode, Q1 in cutoff, with the base voltage at 0V, and V<sub>OUT</sub> forced high.

If V<sub>IN</sub> falls below V<sub>L</sub>, the output of A2 will be high, current will flow through D2, and V<sub>OUT</sub> will be low. Likewise, if V<sub>IN</sub> rises above V<sub>H</sub>, the output of A1 will be high, current will flow through D1, and V<sub>OUT</sub> will be low.

The window comparator threshold voltages are set as follows:

$$V_H = \frac{R_2}{R_1 + R_2} \quad (6)$$

$$V_L = \frac{R_4}{R_3 + R_4} \quad (7)$$

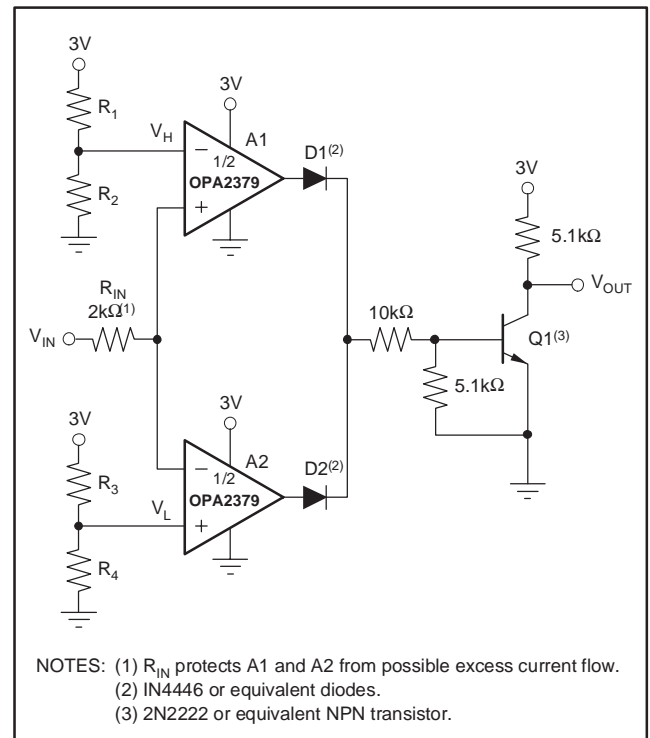

NOTES: (1) R<sub>IN</sub> protects A1 and A2 from possible excess current flow.  
(2) 1N4446 or equivalent diodes.  
(3) 2N2222 or equivalent NPN transistor.

Figure 6. OPA2379 as a Window Comparator

**PACKAGING INFORMATION**

Orderable Device	Status <sup>(1)</sup>	Package Type	Package Drawing	Pins	Package Qty	Eco Plan <sup>(2)</sup>	Lead/Ball Finish	MSL Peak Temp <sup>(3)</sup>
OPA2379AID	ACTIVE	SOIC	D	8	75	Green (RoHS & no Sb/Br)	CU NIPDAU	Level-2-260C-1 YEAR
OPA2379AIDG4	ACTIVE	SOIC	D	8	75	Green (RoHS & no Sb/Br)	CU NIPDAU	Level-2-260C-1 YEAR
OPA2379AIDR	ACTIVE	SOIC	D	8	2500	Green (RoHS & no Sb/Br)	CU NIPDAU	Level-2-260C-1 YEAR
OPA2379AIDRG4	ACTIVE	SOIC	D	8	2500	Green (RoHS & no Sb/Br)	CU NIPDAU	Level-2-260C-1 YEAR
OPA379AID	ACTIVE	SOIC	D	8	75	Green (RoHS & no Sb/Br)	CU NIPDAU	Level-2-260C-1 YEAR
OPA379AIDG4	ACTIVE	SOIC	D	8	75	Green (RoHS & no Sb/Br)	CU NIPDAU	Level-2-260C-1 YEAR
OPA379AIDR	ACTIVE	SOIC	D	8	2500	Green (RoHS & no Sb/Br)	CU NIPDAU	Level-2-260C-1 YEAR
OPA379AIDRG4	ACTIVE	SOIC	D	8	2500	Green (RoHS & no Sb/Br)	CU NIPDAU	Level-2-260C-1 YEAR

<sup>(1)</sup> The marketing status values are defined as follows:

**ACTIVE:** Product device recommended for new designs.

**LIFEBUY:** TI has announced that the device will be discontinued, and a lifetime-buy period is in effect.

**NRND:** Not recommended for new designs. Device is in production to support existing customers, but TI does not recommend using this part in a new design.

**PREVIEW:** Device has been announced but is not in production. Samples may or may not be available.

**OBSOLETE:** TI has discontinued the production of the device.

<sup>(2)</sup> Eco Plan - The planned eco-friendly classification: Pb-Free (RoHS), Pb-Free (RoHS Exempt), or Green (RoHS & no Sb/Br) - please check <http://www.ti.com/productcontent> for the latest availability information and additional product content details.

**TBD:** The Pb-Free/Green conversion plan has not been defined.

**Pb-Free (RoHS):** TI's terms "Lead-Free" or "Pb-Free" mean semiconductor products that are compatible with the current RoHS requirements for all 6 substances, including the requirement that lead not exceed 0.1% by weight in homogeneous materials. Where designed to be soldered at high temperatures, TI Pb-Free products are suitable for use in specified lead-free processes.

**Pb-Free (RoHS Exempt):** This component has a RoHS exemption for either 1) lead-based flip-chip solder bumps used between the die and package, or 2) lead-based die adhesive used between the die and leadframe. The component is otherwise considered Pb-Free (RoHS compatible) as defined above.

**Green (RoHS & no Sb/Br):** TI defines "Green" to mean Pb-Free (RoHS compatible), and free of Bromine (Br) and Antimony (Sb) based flame retardants (Br or Sb do not exceed 0.1% by weight in homogeneous material)

<sup>(3)</sup> MSL, Peak Temp. -- The Moisture Sensitivity Level rating according to the JEDEC industry standard classifications, and peak solder temperature.

**Important Information and Disclaimer:** The information provided on this page represents TI's knowledge and belief as of the date that it is provided. TI bases its knowledge and belief on information provided by third parties, and makes no representation or warranty as to the accuracy of such information. Efforts are underway to better integrate information from third parties. TI has taken and continues to take reasonable steps to provide representative and accurate information but may not have conducted destructive testing or chemical analysis on incoming materials and chemicals. TI and TI suppliers consider certain information to be proprietary, and thus CAS numbers and other limited information may not be available for release.

In no event shall TI's liability arising out of such information exceed the total purchase price of the TI part(s) at issue in this document sold by TI to Customer on an annual basis.

D (R-PDSO-G8)

PLASTIC SMALL-OUTLINE PACKAGE



- NOTES:
- A. All linear dimensions are in inches (millimeters).
  - B. This drawing is subject to change without notice.
  - C. Body dimensions do not include mold flash or protrusion not to exceed 0.006 (0,15).
  - D. Falls within JEDEC MS-012 variation AA.

## IMPORTANT NOTICE

Texas Instruments Incorporated and its subsidiaries (TI) reserve the right to make corrections, modifications, enhancements, improvements, and other changes to its products and services at any time and to discontinue any product or service without notice. Customers should obtain the latest relevant information before placing orders and should verify that such information is current and complete. All products are sold subject to TI's terms and conditions of sale supplied at the time of order acknowledgment.

TI warrants performance of its hardware products to the specifications applicable at the time of sale in accordance with TI's standard warranty. Testing and other quality control techniques are used to the extent TI deems necessary to support this warranty. Except where mandated by government requirements, testing of all parameters of each product is not necessarily performed.

TI assumes no liability for applications assistance or customer product design. Customers are responsible for their products and applications using TI components. To minimize the risks associated with customer products and applications, customers should provide adequate design and operating safeguards.

TI does not warrant or represent that any license, either express or implied, is granted under any TI patent right, copyright, mask work right, or other TI intellectual property right relating to any combination, machine, or process in which TI products or services are used. Information published by TI regarding third-party products or services does not constitute a license from TI to use such products or services or a warranty or endorsement thereof. Use of such information may require a license from a third party under the patents or other intellectual property of the third party, or a license from TI under the patents or other intellectual property of TI.

Reproduction of information in TI data books or data sheets is permissible only if reproduction is without alteration and is accompanied by all associated warranties, conditions, limitations, and notices. Reproduction of this information with alteration is an unfair and deceptive business practice. TI is not responsible or liable for such altered documentation.

Resale of TI products or services with statements different from or beyond the parameters stated by TI for that product or service voids all express and any implied warranties for the associated TI product or service and is an unfair and deceptive business practice. TI is not responsible or liable for any such statements.

Following are URLs where you can obtain information on other Texas Instruments products and application solutions:

<b>Products</b>		<b>Applications</b>	
Amplifiers	<a href="http://amplifier.ti.com">amplifier.ti.com</a>	Audio	<a href="http://www.ti.com/audio">www.ti.com/audio</a>
Data Converters	<a href="http://dataconverter.ti.com">dataconverter.ti.com</a>	Automotive	<a href="http://www.ti.com/automotive">www.ti.com/automotive</a>
DSP	<a href="http://dsp.ti.com">dsp.ti.com</a>	Broadband	<a href="http://www.ti.com/broadband">www.ti.com/broadband</a>
Interface	<a href="http://interface.ti.com">interface.ti.com</a>	Digital Control	<a href="http://www.ti.com/digitalcontrol">www.ti.com/digitalcontrol</a>
Logic	<a href="http://logic.ti.com">logic.ti.com</a>	Military	<a href="http://www.ti.com/military">www.ti.com/military</a>
Power Mgmt	<a href="http://power.ti.com">power.ti.com</a>	Optical Networking	<a href="http://www.ti.com/opticalnetwork">www.ti.com/opticalnetwork</a>
Microcontrollers	<a href="http://microcontroller.ti.com">microcontroller.ti.com</a>	Security	<a href="http://www.ti.com/security">www.ti.com/security</a>
		Telephony	<a href="http://www.ti.com/telephony">www.ti.com/telephony</a>
		Video & Imaging	<a href="http://www.ti.com/video">www.ti.com/video</a>
		Wireless	<a href="http://www.ti.com/wireless">www.ti.com/wireless</a>

Mailing Address: Texas Instruments  
Post Office Box 655303 Dallas, Texas 75265

Copyright © 2006, Texas Instruments Incorporated