

# Low-Cost, Low-Power, 6-Bit DACs with 3-Wire Serial Interface in SOT23

## General Description

The MAX5363/MAX5364/MAX5365 low-cost, 6-bit digital-to-analog converters (DACs) in miniature 6-pin SOT23 packages have a simple 3-wire, SPI™/QSPI™/MICROWIRE™-compatible serial interface that operates up to 10MHz. The MAX5363 has an internal +2V reference and operates from a +2.7V to +3.6V supply. The MAX5364 has an internal +4V reference and operates from a +4.5V to +5.5V supply. The MAX5365 operates over the full +2.7 to +5.5V supply range and has an internal reference equal to  $0.9 \times V_{DD}$ .

The MAX5363/MAX5364/MAX5365 require an extremely low supply current of only 150µA (typ) and provide a buffered voltage output. These devices power up at zero code and remain there until a new code is written to the DAC registers. This provides additional safety for applications that drive valves or other transducers that need to be off on power-up. The MAX5363/MAX5364/MAX5365 include a 1µA, low-power shutdown mode that features software-selectable output loads of 1kΩ, 100kΩ, or 1MΩ to ground.

## Applications

Automatic Tuning (VCO)  
Power Amplifier Bias Control  
Programmable Threshold Levels  
Automatic Gain Control (AGC)

*SPI and QSPI are trademarks of Motorola, Inc.  
MICROWIRE is a trademark of National Semiconductor Corp.*

## Typical Operating Circuit

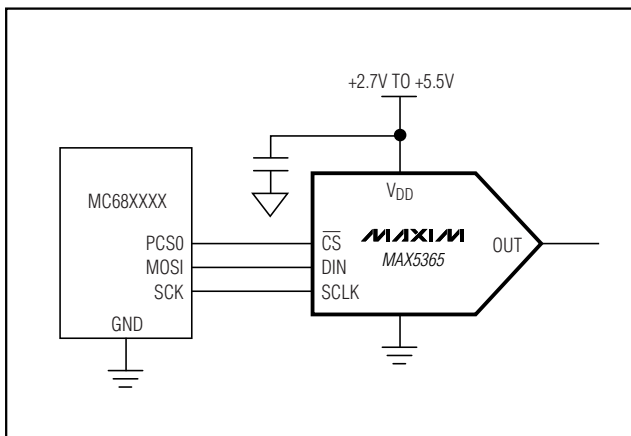

## Features

- ◆ 6-Bit Resolution in a Miniature 6-Pin SOT23 Package
- ◆ Wide +2.7V to +5.5V Supply Range (MAX5365)
- ◆ <1µA Shutdown Mode
- ◆ Software-Selectable Output Resistance During Shutdown
- ◆ Buffered Output Drives Resistive Loads
- ◆ Low-Glitch Power-On Reset to Zero DAC Output
- ◆ 3-Wire SPI/QSPI/MICROWIRE-Compatible Interface
- ◆ <±5% Full-Scale Error (MAX5365)
- ◆ <±1LSB max INL/DNL
- ◆ Low 230µA max Supply Current

## Ordering Information

PART	TEMP. RANGE	PIN-PACKAGE	SOT TOP MARK
MAX5363EUT-T	-40°C to +85°C	6 SOT23-6	AADE
MAX5364EUT-T	-40°C to +85°C	6 SOT23-6	AADG
MAX5365EUT-T	-40°C to +85°C	6 SOT23-6	AAAI

## Selector Table

PART	INTERNAL REFERENCE
MAX5363	2V
MAX5364	4V
MAX5365	$0.9 \times V_{DD}$

## Pin Configuration

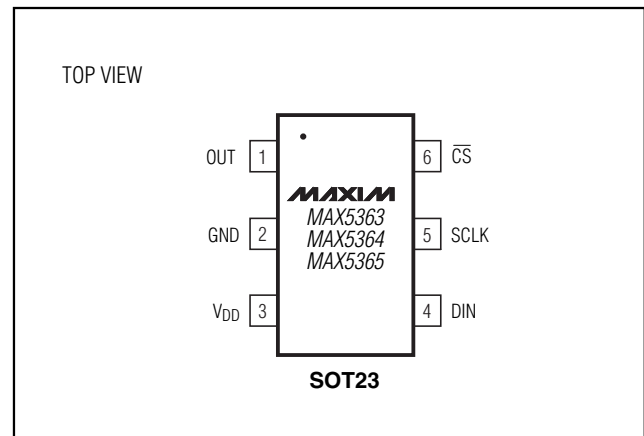

# Low-Cost, Low-Power, 6-Bit DACs with 3-Wire Serial Interface in SOT23

## ABSOLUTE MAXIMUM RATINGS

V <sub>DD</sub> to GND .....	-0.3V to +6V	Operating Temperature Range .....	-40°C to +85°C
OUT .....	-0.3V to (V <sub>DD</sub> + 0.3V)	Storage Temperature Range .....	-65°C to +150°C
CS, SCLK, DIN to GND .....	-0.3V to +6V	Maximum Junction Temperature .....	+150°C
Maximum Current into Any Pin.....	50mA	Lead Temperature (soldering, 10s) .....	+300°C
Continuous Power Dissipation (T <sub>A</sub> = +70°C)			
6-Pin SOT23 (derate 8.7mW/°C above +70°C).....	696mW		

Stresses beyond those listed under "Absolute Maximum Ratings" may cause permanent damage to the device. These are stress ratings only, and functional operation of the device at these or any other conditions beyond those indicated in the operational sections of the specifications is not implied. Exposure to absolute maximum rating conditions for extended periods may affect device reliability.

## ELECTRICAL CHARACTERISTICS

(V<sub>DD</sub> = +2.7V to +3.6V (MAX5363), V<sub>DD</sub> = +4.5V to +5.5V (MAX5364), V<sub>DD</sub> = +2.7V to +5.5V (MAX5365), R<sub>L</sub> = 10kΩ, C<sub>L</sub> = 50pF, T<sub>A</sub> = T<sub>MIN</sub> to T<sub>MAX</sub>, unless otherwise noted. Typical values are T<sub>A</sub> = +25°C.)

PARAMETER	SYMBOL	CONDITIONS	MIN	TYP	MAX	UNITS
<b>STATIC ACCURACY</b>						
Resolution			6			Bits
Integral Linearity Error	INL	(Note 1)			±1	LSB
Differential Linearity Error	DNL	Guaranteed monotonic			±1	LSB
Offset Error	V <sub>OS</sub>	(Note 2)		±1	±25	mV
Offset Error Supply Rejection		MAX5365 (Notes 2, 3)			60	dB
Offset Error Temperature Coefficient		MAX5363/MAX5364		3		ppm/°C
		MAX5365		1		
Full-Scale Error		Code = 63, no load	MAX5363/MAX5364		10	% of ideal FS
			MAX5365		5	
Full-Scale Error Supply		Code = 63 (Note 4)			50	dB
Full-Scale Error Temperature Coefficient		Code = 63	MAX5363/MAX5364		±40	ppm/°C
			MAX5365		±10	
<b>DAC OUTPUT</b>						
Internal Reference Voltage (Note 5)	REF	MAX5363	1.8	2	2.2	V
		MAX5364	3.6	4	4.4	
		MAX5365	0.85 × V <sub>DD</sub>	0.9 × V <sub>DD</sub>	0.95 × V <sub>DD</sub>	
Output Load Regulation		Code = 63, 0 to 100μA		0.5		LSB
		Code = 0, 0 to 100μA		0.5		
Shutdown Output Resistance to GND		V <sub>OUT</sub> = 0 to V <sub>DD</sub>	[D13, D12] = 0, 1		1k	Ω
			[D13, D12] = 1, 0		100k	
			[D13, D12] = 1, 1		1M	
<b>DYNAMIC PERFORMANCE</b>						
Voltage Output Slew Rate		Positive and negative		0.4		V/μs
Output Settling Time		To 1/2 LSB, 50kΩ and 50pF load (Note 6)		20		μs
Digital Feedthrough		Code = 0, all digital inputs from 0 to V <sub>DD</sub>		2		nVs

# Low-Cost, Low-Power, 6-Bit DACs with 3-Wire Serial Interface in SOT23

MAX5363/MAX5364/MAX5365

## ELECTRICAL CHARACTERISTICS (continued)

( $V_{DD} = +2.7V$  to  $+3.6V$  (MAX5363),  $V_{DD} = +4.5V$  to  $+5.5V$  (MAX5364),  $V_{DD} = +2.7V$  to  $+5.5V$  (MAX5365),  $R_L = 10k\Omega$ ,  $C_L = 50pF$ ,  $T_A = T_{MIN}$  to  $T_{MAX}$ , unless otherwise noted. Typical values are  $T_A = +25^\circ C$ .)

PARAMETER	SYMBOL	CONDITIONS	MIN	TYP	MAX	UNITS
Digital-Analog Glitch Impulse		Code 31 to code 32		40		nVs
Wake-Up Time		From software shutdown		50		$\mu s$
<b>POWER REQUIREMENTS</b>						
Supply Voltage	$V_{DD}$	MAX5363	2.7		3.6	V
		MAX5364	4.5		5.5	
		MAX5365	2.7		5.5	
Supply Current	$I_{DD}$	No load, all digital inputs at 0 or $V_{DD}$ , code = 63		150	230	$\mu A$
		Shutdown mode			1	
<b>DIGITAL INPUTS</b>						
Input Low Voltage	$V_{IL}$				$0.3 \times V_{DD}$	V
Input High Voltage	$V_{IH}$		$0.7 \times V_{DD}$			V
Input Hysteresis	$V_H$			$0.05 \times V_{DD}$		V
Input Capacitance	$C_{IN}$	(Note 7)		10		pF
Input Leakage Current	$I_{IN}$				$\pm 1$	$\mu A$

## TIMING CHARACTERISTICS

(Figures 3 and 4,  $V_{DD} = +2.7V$  to  $+3.6V$  (MAX5363),  $V_{DD} = +4.5V$  to  $+5.5V$  (MAX5364),  $V_{DD} = +2.7V$  to  $+5.5V$  (MAX5365),  $R_L = 10k\Omega$ ,  $C_L = 50pF$ ,  $T_A = T_{MIN}$  to  $T_{MAX}$ , unless otherwise noted. Typical values are  $T_A = +25^\circ C$ .) (Note 7)

PARAMETER	SYMBOL	CONDITIONS	MIN	TYP	MAX	UNITS
SCLK Period	$t_{CP}$		100			ns
SCLK Pulse Width High	$t_{CH}$		40			ns
SCLK Pulse Width Low	$t_{CL}$		40			ns
$\overline{CS}$ Fall to SCLK Rise Setup Time	$t_{CSS}$		40			ns
SCLK Rise to $\overline{CS}$ Rise Hold Time	$t_{CSH}$		0			ns
DIN Setup Time	$t_{DS}$		40			ns
DIN Hold Time	$t_{DH}$		0			ns
SCLK Rise to $\overline{CS}$ Fall Delay	$t_{CS0}$		10			ns
$\overline{CS}$ Rise to SCLK Rise Hold	$t_{CS1}$		40			ns
$\overline{CS}$ Pulse Width High	$t_{CSW}$		100			ns

# Low-Cost, Low-Power, 6-Bit DACs with 3-Wire Serial Interface in SOT23

## TIMING CHARACTERISTICS (continued)

(Figures 3 and 4,  $V_{DD} = +2.7V$  to  $+3.6V$  (MAX5363),  $V_{DD} = +4.5V$  to  $+5.5V$  (MAX5364),  $V_{DD} = +2.7V$  to  $+5.5V$  (MAX5365),  $R_L = 10k\Omega$ ,  $C_L = 50pF$ ,  $T_A = T_{MIN}$  to  $T_{MAX}$ , unless otherwise noted. Typical values are  $T_A = +25^\circ C$ .) (Note 7)

**Note 1:** Guaranteed from code 2 to code 63.

**Note 2:** The offset value extrapolated from the range over which the INL is guaranteed.

**Note 3:** MAX5365 tested at  $5V \pm 10\%$ .

**Note 4:** MAX5363 tested at  $3V \pm 10\%$ ; MAX5364 tested at  $5V \pm 10\%$ .

**Note 5:** Actual output voltages at full scale are  $63/64 \times V_{REF}$ .

**Note 6:** Output settling time is measured by stepping from code 2 to code 63, and from code 63 to code 2.

**Note 7:** Guaranteed by design.

## Typical Operating Characteristics

( $V_{DD} = +3.0V$  (MAX5363),  $V_{DD} = +5.0V$  (MAX5364/MAX5365),  $T_A = +25^\circ C$ , unless otherwise noted.)

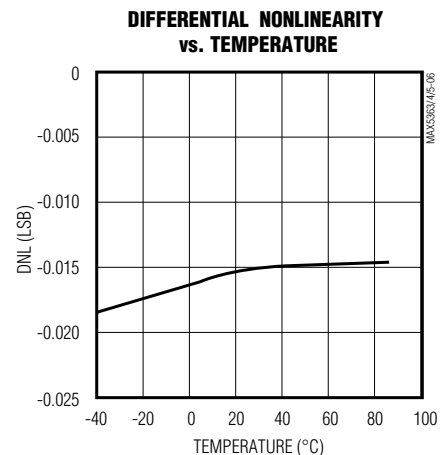
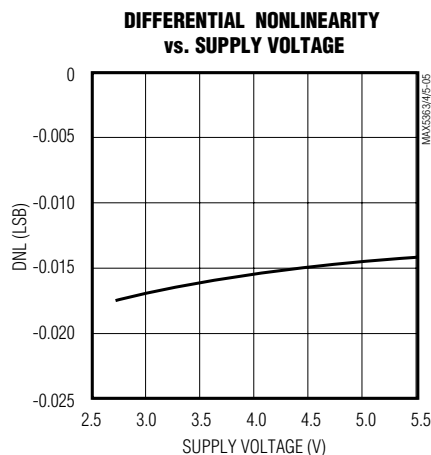
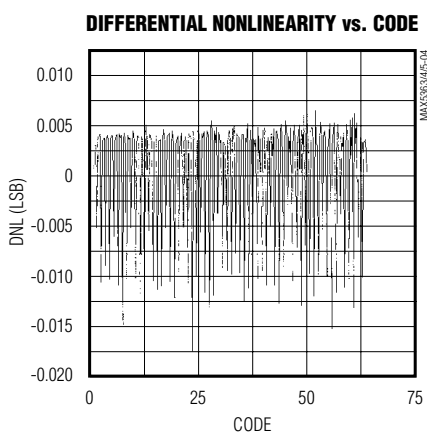
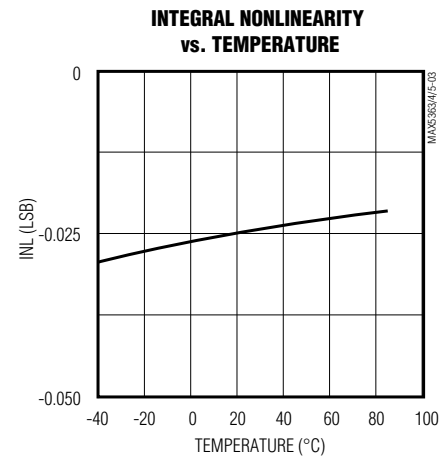
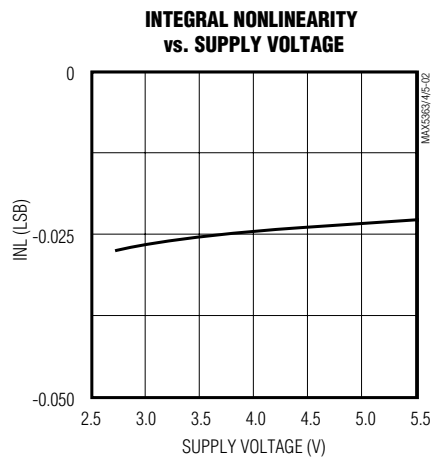
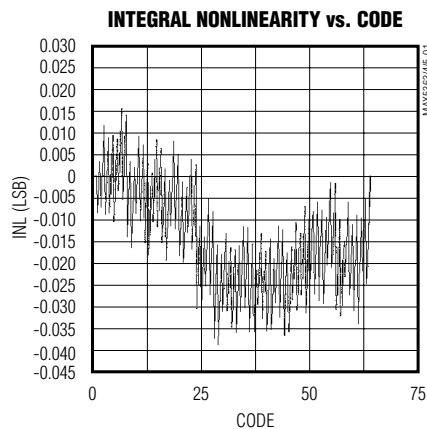

# Low-Cost, Low-Power, 6-Bit DACs with 3-Wire Serial Interface in SOT23

## Typical Operating Characteristics (continued)

( $V_{DD} = +3.0V$  (MAX5363),  $V_{DD} = +5.0V$  (MAX5364/MAX5365),  $T_A = +25^\circ C$ , unless otherwise noted.)

MAX5363/MAX5364/MAX5365

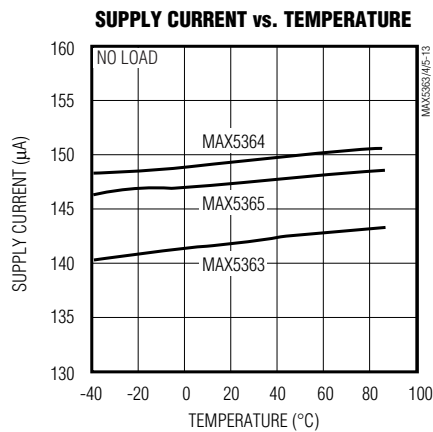
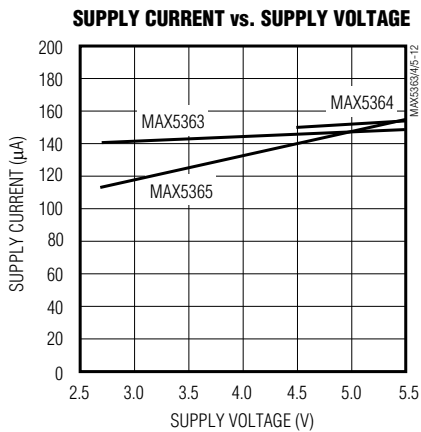
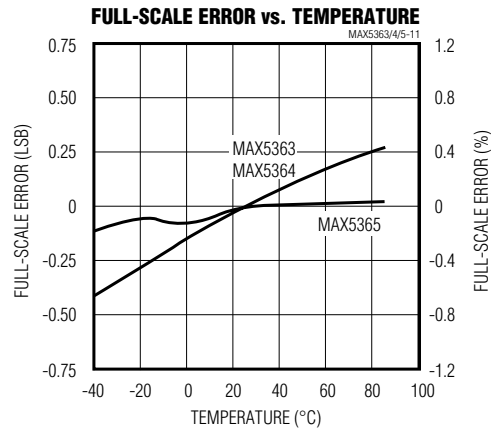
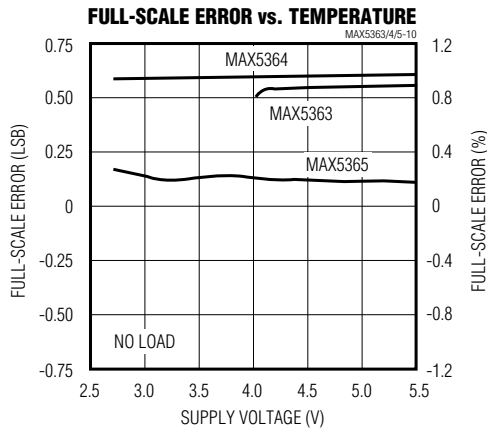
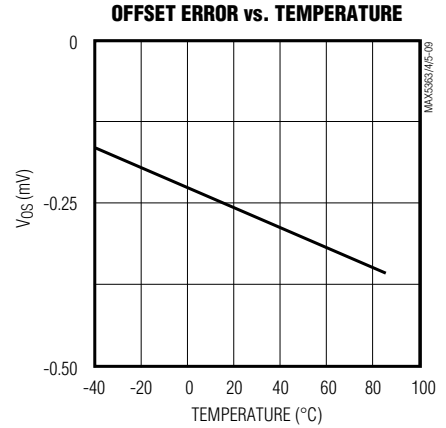
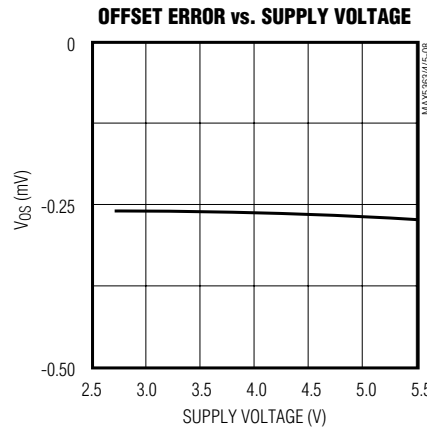
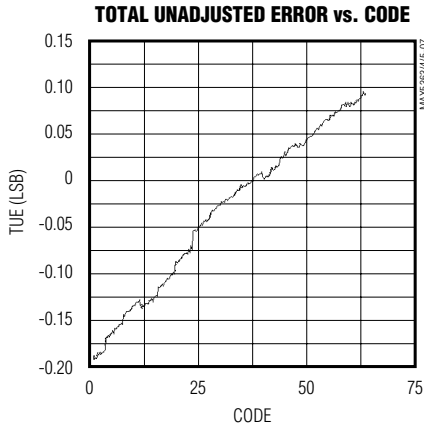

# Low-Cost, Low-Power, 6-Bit DACs with 3-Wire Serial Interface in SOT23

## Typical Operating Characteristics (continued)

( $V_{DD} = +3.0V$  (MAX5363),  $V_{DD} = +5.0V$  (MAX5364/MAX5365),  $T_A = +25^\circ C$ , unless otherwise noted.)

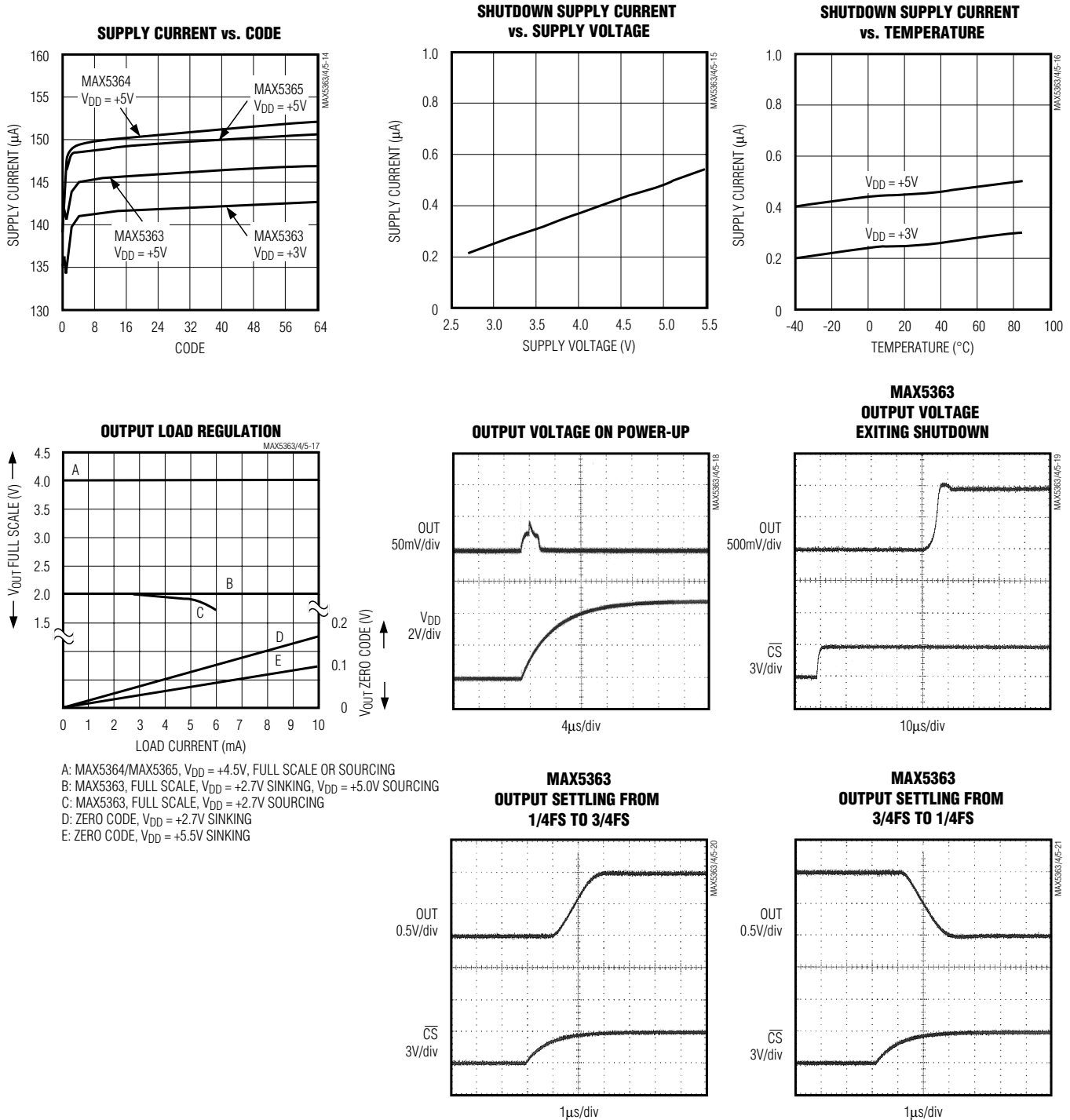

A: MAX5364/MAX5365,  $V_{DD} = +4.5V$ , FULL SCALE OR SOURCING  
 B: MAX5363, FULL SCALE,  $V_{DD} = +2.7V$  SINKING,  $V_{DD} = +5.0V$  SOURCING  
 C: MAX5363, FULL SCALE,  $V_{DD} = +2.7V$  SOURCING  
 D: ZERO CODE,  $V_{DD} = +2.7V$  SINKING  
 E: ZERO CODE,  $V_{DD} = +5.5V$  SINKING

# Low-Cost, Low-Power, 6-Bit DACs with 3-Wire Serial Interface in SOT23

## Typical Operating Characteristics (continued)

( $V_{DD} = +3.0V$  (MAX5363),  $V_{DD} = +5.0V$  (MAX5364/MAX5365),  $T_A = +25^\circ C$ , unless otherwise noted.)

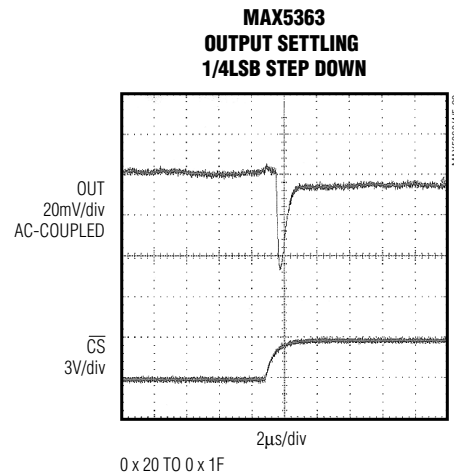
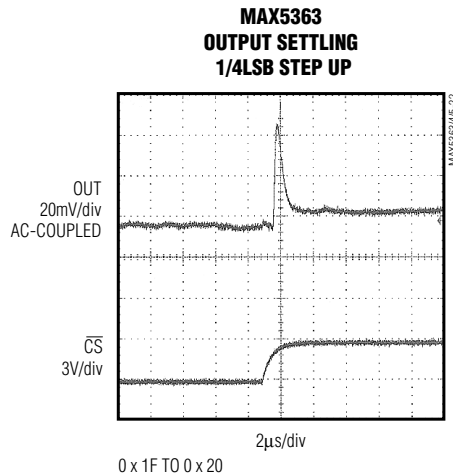

### Pin Description

PIN	NAME	FUNCTION
1	OUT	DAC Voltage Output
2	GND	Ground
3	$V_{DD}$	Power-Supply Input
4	DIN	Serial Data Input
5	SCLK	Serial Clock Input
6	$\overline{CS}$	Chip-Select Input

### Detailed Description

The MAX5363/MAX5364/MAX5365 voltage-output, 6-bit DACs offer full 6-bit performance with less than 1LSB integral nonlinearity error and less than 1LSB differential nonlinearity error, ensuring monotonic performance. The devices use a simple 3-wire, SPI/QSPI/MICROWIRE-compatible serial interface that operates up to 10MHz. The MAX5363/MAX5364/MAX5365 include an internal reference, an output buffer, and three low-current shut-down modes, making these devices ideal for low-power, highly integrated applications. Figure 1 shows the devices' functional diagram.

### Analog Section

The MAX5363/MAX5364/MAX5365 employ a current-steering DAC topology as shown in Figure 2. At the core of the DAC is a reference voltage-to-current converter ( $V/I$ ) that generates a reference current. This current is mirrored to 63 equally weighted current sources. DAC switches control the outputs of these current mirrors so that only the desired fraction of the total current-mirror currents is steered to the DAC output. The current is then converted to a voltage across a resistor, and this voltage is buffered by the output buffer amplifier.

### Output Voltage

Table 1 shows the relationship between the DAC code and the analog output voltage. The 6-bit DAC code is binary unipolar with  $1LSB = (V_{REF}/64)$ . The MAX5363/MAX5364 have a full-scale output voltage of  $(+2V - 1LSB)$  and  $(+4V - 1LSB)$ , respectively, set by the internal references. The MAX5365 has a full-scale output voltage of  $(0.9 \times V_{DD} - 1LSB)$ .

### Output Buffer

The DAC voltage output is an internally buffered unity-gain follower that slews up to  $\pm 0.4V/\mu s$ . The output can swing from 0 to full scale. With a 1/4FS to 3/4FS output transition, the amplifier outputs typically settle to 1/2LSB in less than  $5\mu s$  when loaded with  $10k\Omega$  in parallel with  $50pF$ . The buffer amplifiers are stable with any

MAX5363/MAX5364/MAX5365

# Low-Cost, Low-Power, 6-Bit DACs with 3-Wire Serial Interface in SOT23

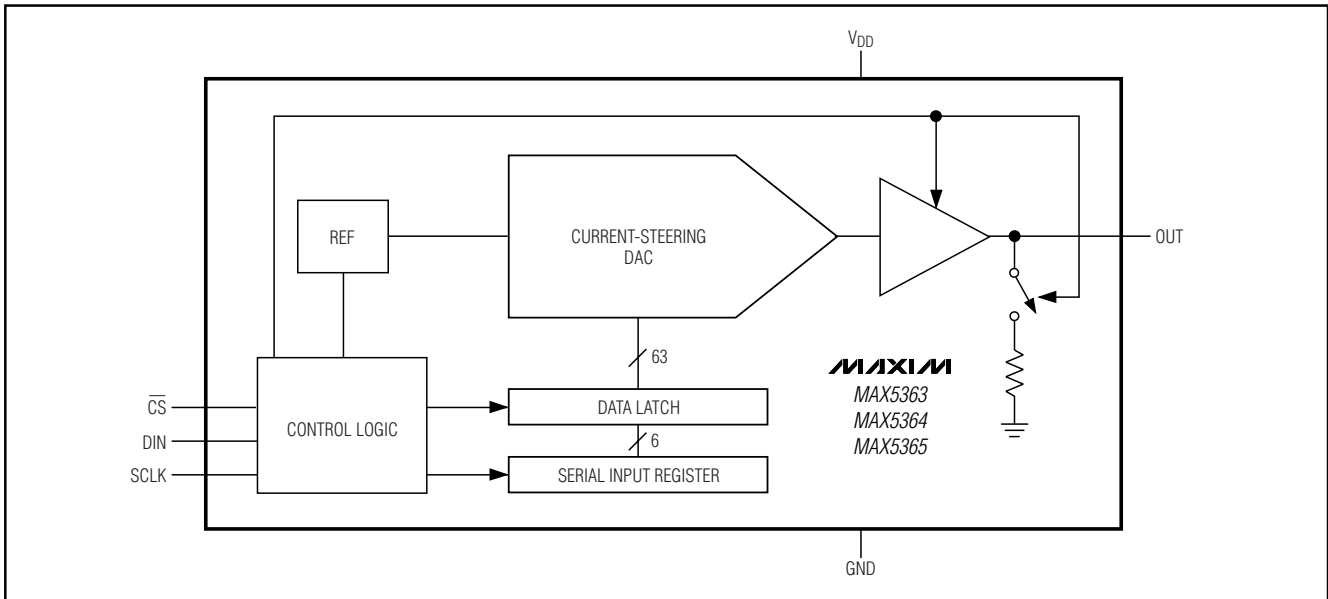

Figure 1. Functional Diagram

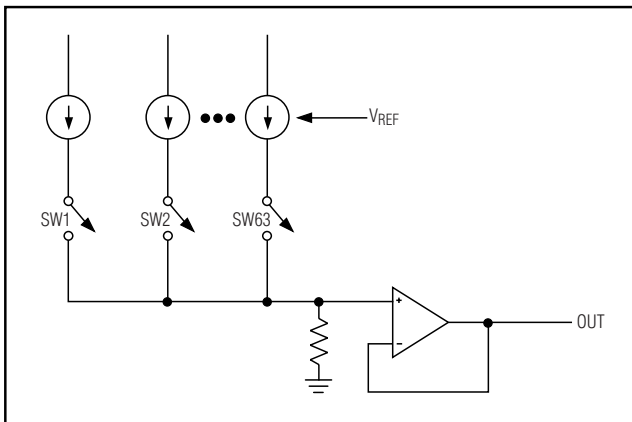

Figure 2. Current-Steering DAC Topology

**Table 1. Unipolar Code Output Voltage**

DAC CODE [D11–D6]	OUTPUT VOLTAGE		
	MAX5363	MAX5364	MAX5365
111 111	$2V \times (63/64)$	$4V \times (63/64)$	$0.9 \times V_{DD} \times (63/64)$
100 000	1V	2V	$0.9 \times V_{DD} / 2$
000 001	31mV	63mV	$0.9 \times V_{DD} / 64$
000 000	0	0	0

combination of resistive loads  $>10k\Omega$  and capacitive loads  $<50pF$ .

### Power-On Reset

The MAX5363/MAX5364/MAX5365 have a power-on reset circuit to set the DAC's output to 0 when  $V_{DD}$  is first applied or when  $V_{DD}$  dips below 1.7V (typ). This ensures that unwanted DAC output voltages will not occur immediately following a system startup, such as after a loss of power. The output glitch on startup is typically less than 50mV.

### Shutdown Mode

The MAX5363/MAX5364/MAX5365 include three software-controlled shutdown modes that reduce the supply current to  $<1\mu A$ . All internal circuitry is disabled, and a known impedance is placed from OUT to GND to ensure 0V while in shutdown. Table 2 details the three shutdown modes of operation.

## Digital Section

### 3-Wire Serial Interface

The MAX5363/MAX5364/MAX5365s' digital interface is a standard 3-wire connection compatible with SPI/QSPI/MICROWIRE interfaces. The chip-select input ( $\overline{CS}$ ) frames the serial data loading at the data-input pin (DIN). Immediately following  $\overline{CS}$ 's high-to-low transition, the data is shifted synchronously and latched into the input register on the rising edge of the serial clock input (SCLK). After 16 bits have been loaded into the serial



# Low-Cost, Low-Power, 6-Bit DACs with 3-Wire Serial Interface in SOT23

input register, it transfers its contents to the DAC latch on  $\overline{CS}$ 's low-to-high transition (Figure 3). Note that if  $\overline{CS}$  is not kept low during the entire 16 SCLK cycles, data will be corrupted. In this case, reload the DAC latch with a new 16-bit word. The serial clock (SCLK) can idle either high or low between transitions. Figure 4 shows the complete 3-wire serial interface transmission. Table 3 lists serial interface mapping.

## Applications Information

### Device Powered by an External Reference

Since the MAX5365 generates an output voltage proportional to  $V_{DD}$ , a noisy power supply will affect the accuracy of the on-board reference, thereby affecting the overall accuracy of the DAC. The circuit in Figure 5 rejects this power-supply noise by powering the device directly with a precision voltage reference, improving overall system accuracy. The MAX6103 (+3V, 75ppm) or the MAX6105 (+5V, 75ppm) precision voltage references are ideal choices due to the low power requirements of the MAX5365. This solution is also useful when the required full-scale output voltage is different from the available supply voltages.

### Digital Inputs and Interface Logic

The digital interface for the 6-bit DAC is based on a 3-wire standard that is compatible with SPI, QSPI, and MICROWIRE interfaces. The three digital inputs ( $\overline{CS}$ , DIN, and SCLK) load the digital input serially into the DAC.

All of the digital inputs include Schmitt-trigger buffers to accept slow-transition interfaces. This means that optocouplers can interface directly to the MAX5363/MAX5364/MAX5365 without additional external logic. The digital inputs are compatible with CMOS logic levels and can be driven with voltages up to +5.5V regardless of the supply voltage.

### Power-Supply Bypassing and Layout

Careful PC board layout is important for best system performance. To reduce crosstalk and noise injection, keep analog and digital signals separate. To ensure that the ground return from GND to the supply ground is short and low impedance, a ground plane is recommended. Bypass  $V_{DD}$  with a 0.1 $\mu$ F to ground as close as possible to the device. If the supply is excessively noisy, connect a 10 $\Omega$  resistor in series with the supply and  $V_{DD}$  and add additional capacitance.

**Table 2. Shutdown Modes**

DAC CODE [D13 AND D12]	MODE	OUTPUT RESISTANCE TO GROUND ( $\Omega$ )	MAXIMUM SUPPLY CURRENT ( $\mu$ A)
01	Shutdown	1k	1
10	Shutdown	100k	1
11	Shutdown	1M	1

**Table 3. Serial Interface Mapping**

16-BIT SERIAL WORD				ANALOG OUTPUT	FUNCTION
MSB			LSB		
XX00	0000	0000	XXXX	0V	Normal operation
XX00	1111	11XX	XXXX	$V_{REF} \times (63/64)$	Normal operation
XX00	0000	01XX	XXXX	$V_{REF} \times (1/64)$	Normal operation
XX00	1000	00XX	XXXX	$V_{REF} \times (32/64)$	Normal operation
XX01	XXXX	XXXX	XXXX	0V	Shutdown, 1k $\Omega$ to GND
XX10	XXXX	XXXX	XXXX	0V	Shutdown, 100k $\Omega$ to GND
XX11	XXXX	XXXX	XXXX	0V	Shutdown, 1M $\Omega$ to GND

X = Don't care

# Low-Cost, Low-Power, 6-Bit DACs with 3-Wire Serial Interface in SOT23

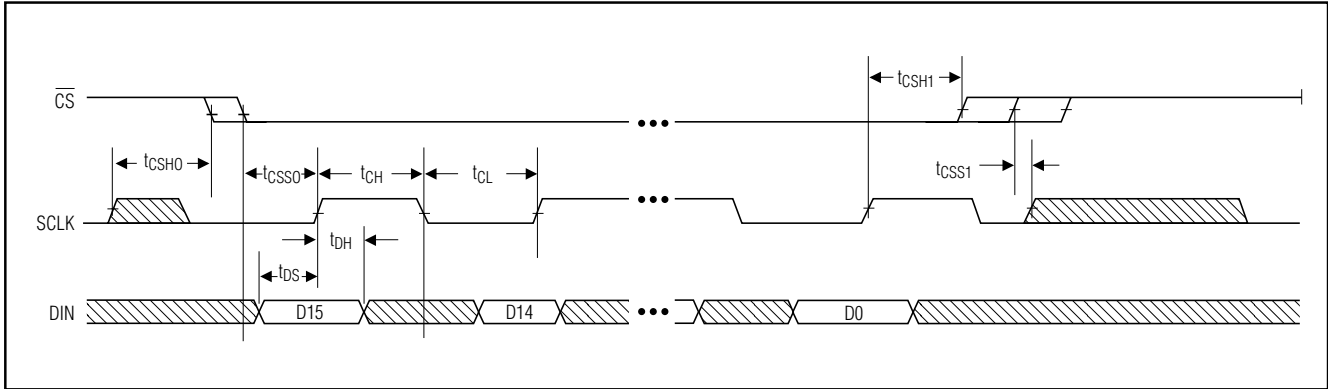

Figure 3. 3-Wire Serial Interface Timing Diagram

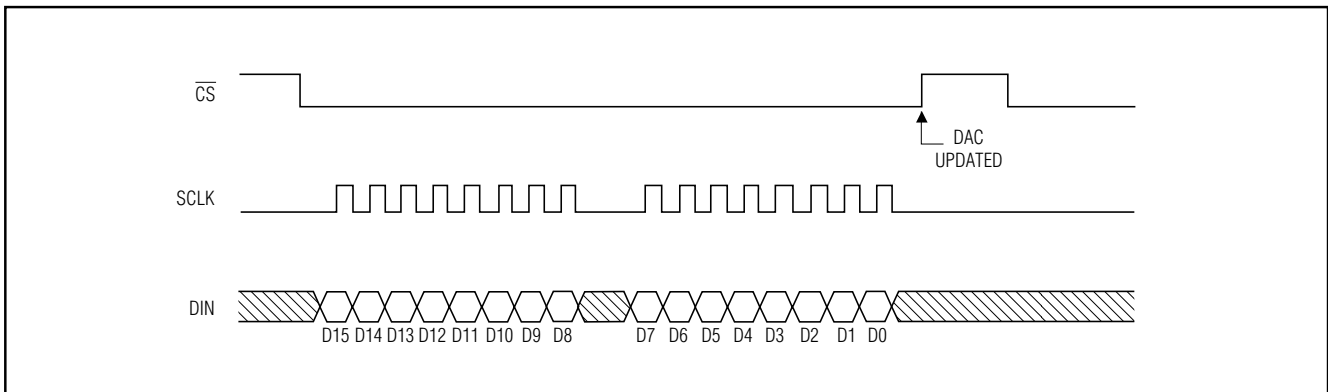

Figure 4. Complete 3-Wire Serial Interface Transmission

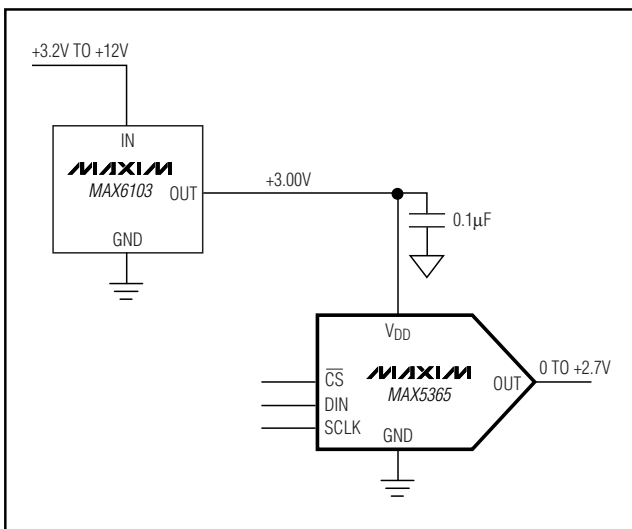

Figure 5. Powering the MAX5365 with a Precision Voltage Reference

**Chip Information**  
TRANSISTOR COUNT: 2160

# Low-Cost, Low-Power, 6-Bit DACs with 3-Wire Serial Interface in SOT23

## Package Information

MAX5363/MAX5364/MAX5365

6LSOT23

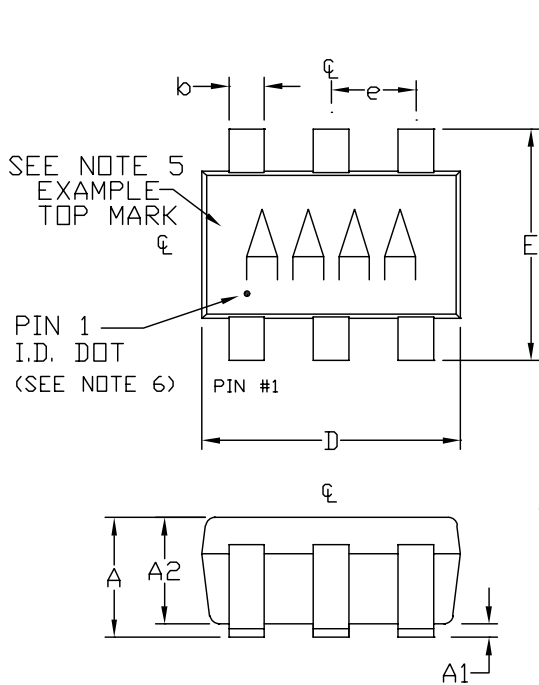

SYMBOL	MIN	MAX
A	0.90	1.45
A1	0.00	0.15
A2	0.90	1.30
b	0.35	0.50
C	0.08	0.20
D	2.80	3.00
E	2.60	3.00
E1	1.50	1.75
L	0.35	0.55
e	0.95 REF	
α	0°	10°

NOTE:

1. ALL DIMENSIONS ARE IN MILLIMETERS.
2. FOOT LENGTH MEASURED AT INTERCEPT POINT BETWEEN DATUM A & LEAD SURFACE.
3. PACKAGE OUTLINE EXCLUSIVE OF MOLD FLASH & METAL BURR.
4. PACKAGE OUTLINE INCLUSIVE OF SOLDER PLATING.
5. PIN 1 IS LOWER LEFT PIN WHEN READING TOP MARK FROM LEFT TO RIGHT. (SEE EXAMPLE TOP MARK)
6. PIN 1 I.D. DOT IS 0.3 MM Ø MIN. LOCATED ABOVE PIN 1.

<b>MAXIM</b>			
PROPRIETARY INFORMATION			
TITLE: PACKAGE OUTLINE, SOT23, 6L			
APPROVAL	DOCUMENT CONTROL NO. 21-0058	REV D	1/1

# **Low-Cost, Low-Power, 6-Bit DACs with 3-Wire Serial Interface in SOT23**

## **NOTES**

*Maxim cannot assume responsibility for use of any circuitry other than circuitry entirely embodied in a Maxim product. No circuit patent licenses are implied. Maxim reserves the right to change the circuitry and specifications without notice at any time.*

**12** \_\_\_\_\_ **Maxim Integrated Products, 120 San Gabriel Drive, Sunnyvale, CA 94086 408-737-7600**

© 2000 Maxim Integrated Products

Printed USA

**MAXIM** is a registered trademark of Maxim Integrated Products.