

# EZ-USB HX2LP Lite™ Low Power USB 2.0 Hub Controller Family

## Features

- USB 2.0 hub controller
- Compliant with the USB 2.0 specification
- USB-IF certified: TID# 30000009
- Windows Hardware Quality Lab (WHQL) compliant
- Up to four downstream ports supported
- Supports bus powered and self powered modes
- Single transaction translator (TT)
- Bus power configurations
- Fit, form, and function compatible with CY7C65640 and CY7C65640A (TetraHub™)
- Space saving 56-pin QFN
- Single power supply requirement
  - Internal regulator for reduced cost
- Integrated upstream pull up resistor
- Integrated pull down resistors for all downstream ports
- Integrated upstream and downstream termination resistors
- Integrated port status indicator control
- 24 MHz external crystal (integrated phase locked loop (PLL))
- In-system EEPROM programming
- Configurable with external SPI EEPROM:
  - Vendor ID, Product ID, Device ID (VID/PID/DID)
  - Number of active ports
  - Number of removable ports
  - Maximum power setting for high speed and full speed
  - Hub controller power setting
  - Power on timer
  - Overcurrent detection mode
  - Enabled and disabled overcurrent timer
  - Overcurrent pin polarity
  - Indicator pin polarity
  - Compound device
  - Enable full speed only
  - Disable port indicators
  - Ganged power switching
  - Self and bus powered compatibility
  - Fully configurable string descriptors for multiple language support

## Block Diagram CY7C65631

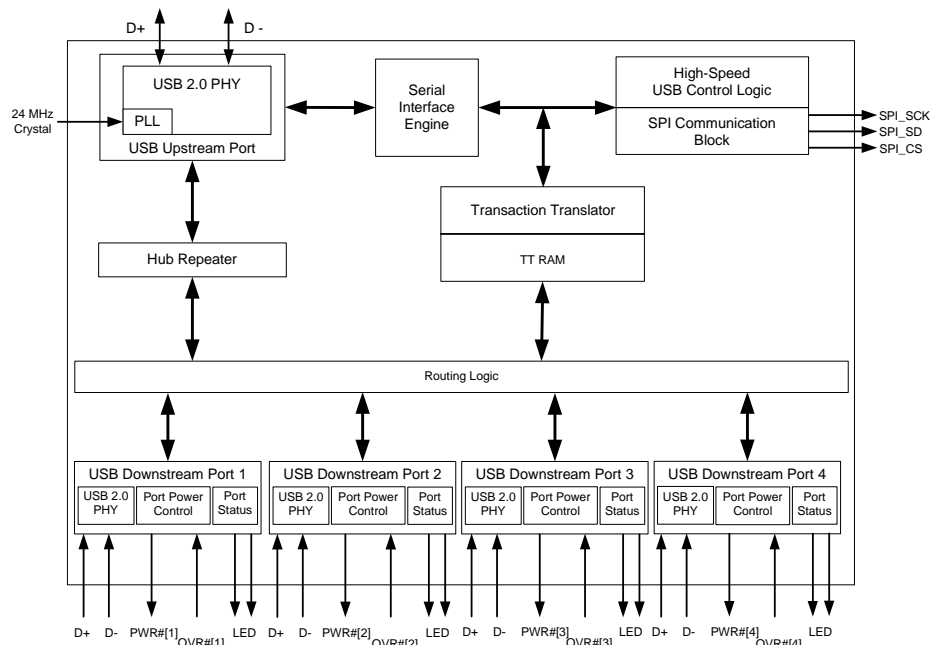

### Block Diagram CY7C65621

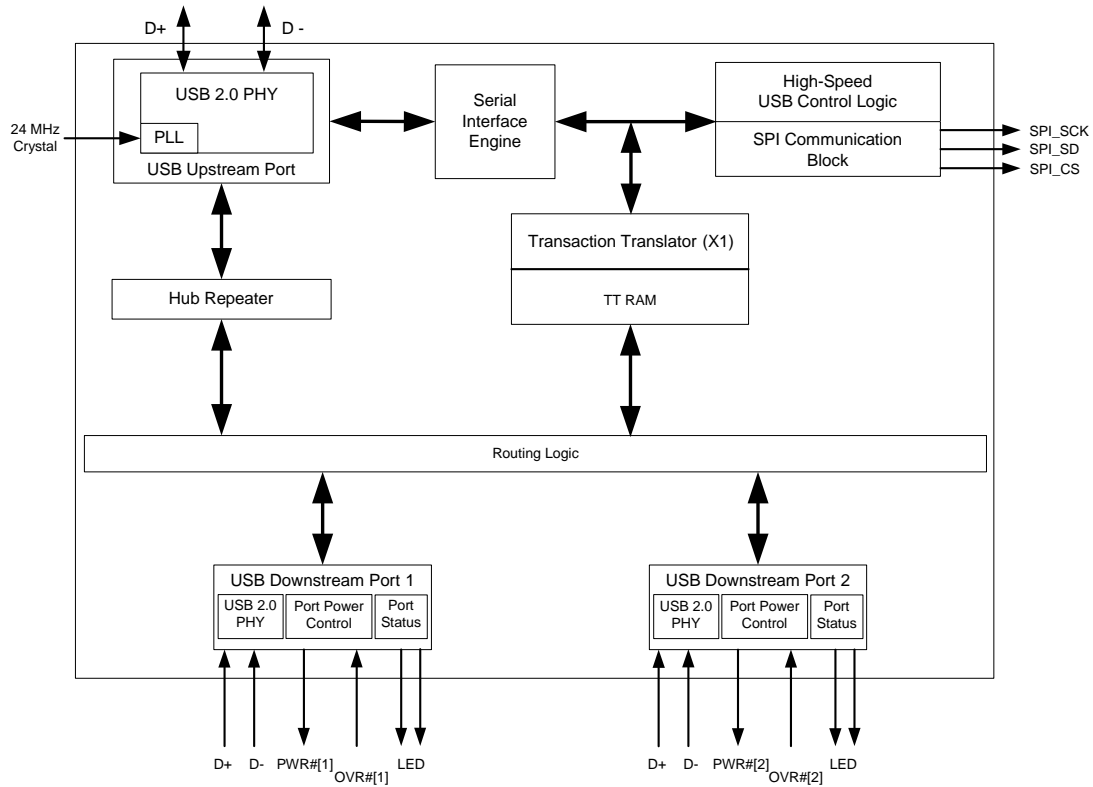

**Contents**

|                                      |           |  |           |
|--------------------------------------|-----------|--|-----------|
| <b>Introduction</b> .....            | <b>4</b>  | <b>Supported USB Requests</b> .....                  | <b>17</b> |
| USB Serial Interface Engine .....    | 4         | Device Class Commands .....                          | 17        |
| Hub Repeater .....                   | 4         | Hub Class Commands .....                             | 18        |
| Transaction Translator .....         | 4         | <b>Upstream USB Connection</b> .....                 | <b>20</b> |
| <b>Applications</b> .....            | <b>4</b>  | <b>Downstream USB Connections</b> .....              | <b>20</b> |
| <b>Functional Overview</b> .....     | <b>4</b>  | <b>LED Connections</b> .....                         | <b>20</b> |
| System Initialization .....          | 4         | <b>System Block Diagram</b> .....                    | <b>21</b> |
| Enumeration .....                    | 4         | <b>Electrical Characteristics</b> .....              | <b>22</b> |
| Downstream Ports .....               | 5         | Absolute Maximum Ratings .....                       | 22        |
| Upstream Port .....                  | 5         | Operating Conditions .....                           | 22        |
| Power Switching .....                | 5         | DC Electrical Characteristics .....                  | 22        |
| Overcurrent Detection .....          | 5         | USB Transceiver .....                                | 22        |
| Port Indicators .....                | 5         | AC Electrical Characteristics .....                  | 22        |
| <b>Pin Configuration</b> .....       | <b>7</b>  | <b>Ordering Information</b> .....                    | <b>23</b> |
| <b>Pin Description Table x</b> ..... | <b>8</b>  | Ordering Code Defintions .....                       | 23        |
| <b>Default Descriptors</b> .....     | <b>10</b> | <b>Package Diagram</b> .....                         | <b>24</b> |
| Device Descriptor .....              | 10        | <b>Acronyms</b> .....                                | <b>25</b> |
| Configuration Descriptor .....       | 10        | <b>Document Conventions</b> .....                    | <b>25</b> |
| Interface Descriptor .....           | 11        | Units of Measure .....                               | 25        |
| Endpoint Descriptor .....            | 11        | <b>ocument History Page</b> .....                    | <b>26</b> |
| Device Qualifier Descriptor .....    | 11        | <b>Sales, Solutions, and Legal Information</b> ..... | <b>27</b> |
| Hub Descriptor .....                 | 12        | Worldwide Sales and Design Support .....             | 27        |
| <b>Configuration Options</b> .....   | <b>13</b> | Products .....                                       | 27        |
| 0xD0 Load .....                      | 13        | PSoC® Solutions .....                                | 27        |
| 0xD2 Load .....                      | 13        |  |           |
| 0xD4 Load .....                      | 14        |  |           |

## Introduction

EZ-USB HX2LP Lite™ is Cypress's next generation family of high performance, low power USB 2.0 hub controllers. HX2LP Lite is an ultra low power single chip USB 2.0 hub controller with integrated upstream and downstream transceivers, a USB Serial Interface Engine (SIE), USB Hub Control and Repeater logic, and Transaction Translator (TT) logic. Cypress has also integrated many external passive components such as pull up and pull down resistors, reducing the overall bill of materials required to implement a hub design. The HX2LP portfolio consists of:

### 1. CY7C65631: 4-port/single transaction translator

This device option is for ultra low power applications that require four downstream ports. All four ports share a single transaction translator. The CY7C65631 is available in a 56 QFN and is also pin-for-pin compatible with the CY7C65640.

### 2. CY7C65621:

This device option is for a 2-port bus powered application. Both ports share a single transaction translator. The CY7C65621 is available in a 56 QFN.

All device options are supported by Cypress' world class reference design kits, which include board schematics, bill of materials, Gerber files, Orcad files, and thorough design documentation.

## USB Serial Interface Engine

The Serial Interface Engine (SIE) allows the CY7C65621/31 to communicate with the USB host. The SIE handles the following USB activity independently of the Hub Control Block.

- Bit stuffing/unstuffing
- Checksum generation/checking
- TOKEN type identification
- Address checking.

## Hub Repeater

The Hub Repeater manages connectivity between upstream and downstream facing ports that are operating at the same speed. It supports full speed, low speed, and high speed connectivity. According to the USB 2.0 specification, the HUB Repeater provides the following functions:

- Sets up and tears down connectivity on packet boundaries
- Ensures orderly entry into and out of the Suspend state, including proper handling of remote wakeups.

## Transaction Translator

The Transaction Translator (TT) basically translates data from one speed to another. A TT takes high speed split transactions and translates them to full or low speed transactions when the hub is operating at high speed (the upstream port is connected to a high speed host controller) and has a full or low speed devices attached. The operating speed of a device attached on a downstream facing port determines whether the Routing Logic connects a port to the Transaction Translator or Hub Repeater. If a full or low speed device is connected to the hub operating at high speed, the data transfer route includes the Transaction

Translator. If a high speed device is connected to this high speed hub, the route only includes the repeater and no Transaction Translator because the device and the hub operate at the same speed. When the hub is operating at full speed (the upstream port is connected to a full speed host controller), a high speed peripheral does not operate at its full capability. These devices only work at full speed. Full and low speed devices connected to this hub operate at their normal speed.

## Applications

Typical applications for the HX2LP Lite device family are:

- Standalone hubs
- Motherboard hubs
- Monitor hubs
- Advanced port replicators
- Docking stations
- Split-PC designs
- External personal storage drives
- Keyboard hubs

## Functional Overview

The Cypress CY7C65621/31 USB 2.0 hubs are high performance, low system cost solutions for USB. The CY7C65621/31 USB 2.0 hubs integrate 1.5 k $\Omega$  upstream pull up resistors for full speed operation and all downstream 15 k $\Omega$  pull down resistors and series termination resistors on all upstream and downstream D+ and D- pins. This results in optimization of system costs by providing built-in support for the USB 2.0 specification.

## System Initialization

On power up, the CY7C65621/31 reads an external SPI EEPROM for configuration information. At the most basic level, this EEPROM has the Vendor ID (VID), Product ID (PID), and Device ID (DID) for the customer's application. For more specialized applications, other configuration options can be specified. See [Configuration Options](#) on page 13 for more details.

After reading the EEPROM, if VBUSPOWER (connected to up-stream V<sub>BUS</sub>) is high, CY7C65621/31 enables the pull up resistor on D+ to indicate its presence to the upstream hub, after which a USB Bus Reset is expected. During this reset, CY7C65621/31 initiates a chirp to indicate that it is a high speed peripheral. In a USB 2.0 system, the upstream hub responds with a chirp sequence, and CY7C65621/31 is in a high speed mode, with the upstream D+ pull up resistor turned off. In USB 1.x systems, no such chirp sequence from the upstream hub is seen, and CY7C65621/31 operates as a normal 1.x hub (operating at full speed).

## Enumeration

After a USB Bus Reset, CY7C65621/31 is in an unaddressed, unconfigured state (configuration value set to '0'). During the enumeration process, the host sets the hub's address and configuration.

When the hub is configured, the full hub functionality is available.

## Downstream Ports

The CY7C65621/31 supports a maximum of four downstream ports, each of which may be marked as usable or removable in the extended configuration (0xD2 EEPROM load or 0xD4 EEPROM load, see [Configuration Options](#) on page 13. Downstream D+ and D– pull down resistors are incorporated in CY7C65621/31 for each port. Before the hubs are configured, the ports are driven SE0 (Single Ended Zero, where both D+ and D– are driven low) and are set to the unpowered state. When the hub is configured, the ports are not driven, and the host may power the ports by sending a SetPortPower command for each port. After a port is powered, any connect or disconnect event is detected by the hub. Any change in the port state is reported by the hubs back to the host through the Status Change Endpoint (endpoint 1). Upon receipt of SetPortReset request for a port with a device connected, the hub does as follows:

- Performs a USB reset on the corresponding port
- Puts the port in an enabled state
- Enables the green port indicator for that port (if not previously overridden by the host)
- Enables babble detection when the port is enabled.

Babble consists of a non idle condition on the port after EOF2. If babble is detected on an enabled port, that port is disabled. A ClearPortEnable request from the host also disables the specified port.

Downstream ports can be individually suspended by the host with the SetPortSuspend request. If the hub is not suspended, a remote wakeup event on that port is reflected to the host through a port change indication in the Hub Status Change Endpoint. If the hub is suspended, a remote wakeup event on this port is forwarded to the host. The host may resume the port by sending a ClearPortSuspend command.

## Upstream Port

The upstream port includes the transmitter and the receiver state machine. The transmitter and receiver operate in high speed and full speed depending on the current hub configuration.

The transmitter state machine monitors the upstream facing port while the Hub Repeater has connectivity in the upstream direction. This machine prevents babble and disconnect events on the downstream facing ports of this hub from propagating and causing the hub to be disabled or disconnected by the hub to which it is attached.

## Power Switching

The CY7C65621/31 includes interface signals for external port power switches. Both ganged and individual (per-port) configurations are supported, with individual switching being the default. Initially all ports are unpowered. After enumerating, the host may power each port by sending a SetPortPower request for that port. The power switching and over-current detection of downstream ports is managed by control pins connected to an external power

switch device. PWR [n]# output pins of the CY7C65621/31 series are connected to the respective external power switch's port power enable signals. Note that each port power output pin of the external power switch must be bypassed with an electrolytic or tantalum capacitor as required by the USB specification. These capacitors supply the inrush currents, which occur during downstream device hot-attach events. The polarity of this pin can be configured through the EEPROM; see [0xD4 Load](#) on page 14.

## Overcurrent Detection

Overcurrent detection includes 8 ms of timed filtering by default. This parameter is configured from the external EEPROM in a range of 0 ms to 15 ms for both enabled ports and disabled ports individually. Detection of overcurrent on downstream ports is managed by control pins connected to an external power switch device.

The OVR[n]# pins of the CY7C65621/31 series are connected to the respective external power switch's port overcurrent indication (output) signals. After detecting an overcurrent condition, hub reports overcurrent condition to the host and disables the PWR# output to the external power device. The polarity of the OVR pins can be configured through the EEPROM; see [0xD4 Load](#) on page 14.

## Port Indicators

The USB 2.0 port indicators are also supported directly by CY7C65621/31. According to the specification, each downstream port of the hub optionally supports a status indicator. The presence of indicators for downstream facing ports is specified by bit 7 of the wHubCharacteristics field of the hub class descriptor. The default CY7C65621/31 descriptor specifies that port indicators are supported (wHubCharacteristics, bit 7 is set). If port indicators are not included in the hub, disable this bit through EEPROM settings.

Each port indicator pin is strategically located directly on the opposite edge of the port with which it is associated. A port indicator provides two colors: green and amber. This is usually implemented as two separate LEDs, one amber and the other green. A combination of hardware and software control is used to inform the user of the current status of the port or the device attached to the port and to guide the user through problem resolution. Colors and blinking provide information to the user. The significance of the color of the LED depends on the operational mode of CY7C65621/31. The CY7C65621/31 port indicators has two modes of operation: automatic and manual.

On power up the CY7C65621/31 defaults to automatic mode, where the color of the Port Indicator (green, amber, off) indicates the functional status of the CY7C65621/31 port. In automatic mode, the CY7C65621/31 turns on the green LED whenever the port is enabled and the amber LED when an overcurrent condition is detected. The color of the port indicator is set by the port state machine. Blinking of the LEDs is not supported in automatic mode. [Table 1](#) identifies the mapping of color to port state in automatic mode.

**Table 1. Automatic Port State to Port Indicator Color Mapping<sup>[1]</sup>**

| Downstream Facing Hub Port State                 |  |                                 |   |
|--|--|---------------------------------|---|
| Powered Off                                      | Disconnected, Disabled, Not Configured, Resetting, Testing | Enabled, Transmit, or TransmitR | Suspended, Resuming, SendEOR, Restart_E/S |
| Off or Amber, if due to an Overcurrent Condition | Off  | Green                           | Off                                       |

The LED control lines can also be modulated with a square wave for power conservation. The polarity of these pins is programmable, see [0xD4 Load](#) on page 14.

In manual mode, the indicators are under the control of the host, which can turn on the LEDs, or leave them off. This is done by a USB hub class request. Blinking of the LEDs is supported in manual mode. The port indicators allow the user to intervene in any error detection. For example, when babble is detected while plugging in a defective device, or when an overcurrent condition occurs, the port indicators corresponding to the downstream port blink green or only light the amber LED, respectively.

[Table 2](#) displays the color definition of the indicators when CY7C65621/31 is in manual mode.<sup>[1]</sup>

**Table 2. Port Indicator Color Definitions in Manual Mode<sup>[2]</sup>**

| Color Definition     | Port State         |
|----------------------|--------------------|
| Off                  | Not Operational    |
| Amber                | Error Condition    |
| Green                | Fully Operational  |
| Blinking Off/Green   | Software Attention |
| Blinking Off/Amber   | Hardware Attention |
| Blinking Green/Amber | Reserved           |

**Notes**

1. Information presented in [Table 1](#) is from USB 2.0 Specification Tables 11-6.
2. Information presented in [Table 2](#) is from USB 2.0 Specification 11-7.

## Pin Configuration

Figure 1. 56-Pin Quad Flat Pack No Leads (8 mm x 8 mm)<sup>[3]</sup>

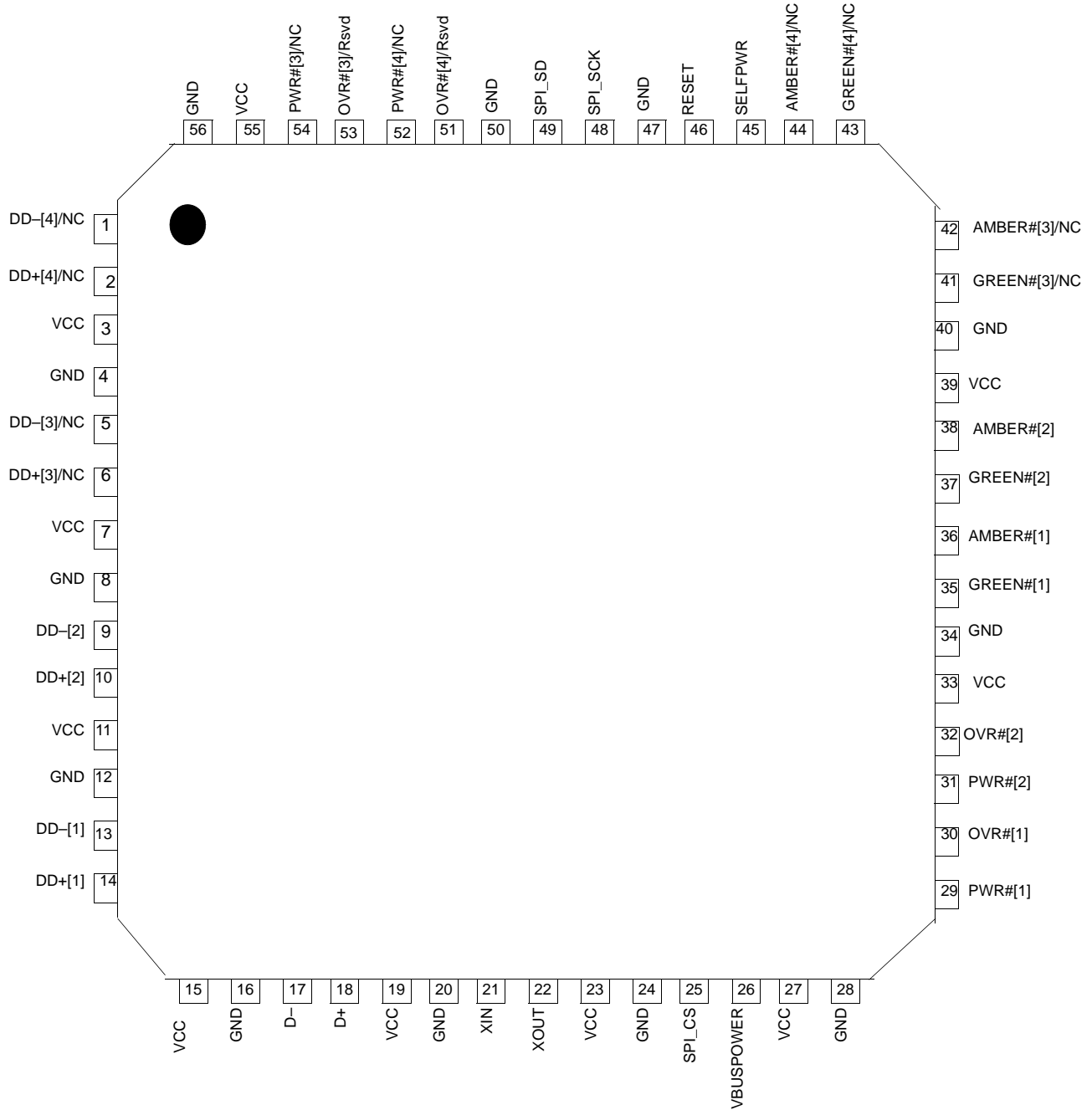

**Note**

3. NC and Rsvd are for CY7C65621 only.



**Pin Description Table x**
**Table 3. Pin Assignments<sup>[4]</sup>**

| Pin                  | CY7C65631 Name | CY7C65621 Name | Type   | Default | Description   |
|----------------------|----------------|----------------|--------|---------|---|
| 3                    | VCC            | VCC            | Power  | N/A     | <b>V<sub>CC</sub></b> . This signal provides power to the chip.   |
| 7                    | VCC            | VCC            | Power  | N/A     | <b>V<sub>CC</sub></b> . This signal provides power to the chip.   |
| 11                   | VCC            | VCC            | Power  | N/A     | <b>V<sub>CC</sub></b> . This signal provides power to the chip.   |
| 15                   | VCC            | VCC            | Power  | N/A     | <b>V<sub>CC</sub></b> . This signal provides power to the chip.   |
| 19                   | VCC            | VCC            | Power  | N/A     | <b>V<sub>CC</sub></b> . This signal provides power to the chip.   |
| 23                   | VCC            | VCC            | Power  | N/A     | <b>V<sub>CC</sub></b> . This signal provides power to the chip.   |
| 27                   | VCC            | VCC            | Power  | N/A     | <b>V<sub>CC</sub></b> . This signal provides power to the chip.   |
| 33                   | VCC            | VCC            | Power  | N/A     | <b>V<sub>CC</sub></b> . This signal provides power to the chip.   |
| 39                   | VCC            | VCC            | Power  | N/A     | <b>V<sub>CC</sub></b> . This signal provides power to the chip.   |
| 55                   | VCC            | VCC            | Power  | N/A     | <b>V<sub>CC</sub></b> . This signal provides power to the chip.   |
| 4                    | GND            | GND            | Power  | N/A     | <b>GND</b> . Connect to ground with as short a path as possible.  |
| 8                    | GND            | GND            | Power  | N/A     | <b>GND</b> . Connect to ground with as short a path as possible.  |
| 12                   | GND            | GND            | Power  | N/A     | <b>GND</b> . Connect to ground with as short a path as possible.  |
| 16                   | GND            | GND            | Power  | N/A     | <b>GND</b> . Connect to ground with as short a path as possible.  |
| 20                   | GND            | GND            | Power  | N/A     | <b>GND</b> . Connect to ground with as short a path as possible.  |
| 24                   | GND            | GND            | Power  | N/A     | <b>GND</b> . Connect to ground with as short a path as possible.  |
| 28                   | GND            | GND            | Power  | N/A     | <b>GND</b> . Connect to ground with as short a path as possible.  |
| 34                   | GND            | GND            | Power  | N/A     | <b>GND</b> . Connect to ground with as short a path as possible.  |
| 40                   | GND            | GND            | Power  | N/A     | <b>GND</b> . Connect to ground with as short a path as possible.  |
| 47                   | GND            | GND            | Power  | N/A     | <b>GND</b> . Connect to ground with as short a path as possible.  |
| 50                   | GND            | GND            | Power  | N/A     | <b>GND</b> . Connect to ground with as short a path as possible.  |
| 56                   | GND            | GND            | Power  | N/A     | <b>GND</b> . Connect to ground with as short a path as possible.  |
| 21                   | XIN            | XIN            | Input  | N/A     | <b>24 MHz Crystal IN or external Clock Input.</b>   |
| 22                   | XOUT           | XOUT           | Output | N/A     | <b>24 MHz Crystal OUT.</b> (NC if external clock is used)   |
| 46                   | RESET#         | RESET#         | Input  | N/A     | <b>Active LOW Reset.</b> This pin resets the entire chip. It is normally tied to V <sub>CC</sub> through a 100K resistor, and to GND through a 0.1 μF capacitor. Other than this, no other special power up procedure is required.                      |
| 45                   | SELPWR         | SELPWR         | Input  | N/A     | <b>Self Power.</b> Indicator for bus or self powered. 0 is bus powered, 1 is self powered.  |
| 26                   | VBUSPOWER      | VBUSPOWER      | Input  | N/A     | <b>VBUS.</b> Connect to the VBUS pin of the upstream connector. This signal indicates to the hub that it is in a connected state, and may enable the D+ pull up resistor to indicate a connection. (The hub does so after the external EEPROM is read). |
| <b>SPI Interface</b> |                |                |        |         |   |
| 25                   | SPI_CS         | SPI_CS         | Output | O       | <b>SPI Chip Select.</b> Connect to CS pin of the EEPROM.  |
| 48                   | SPI_SCK        | SPI_SCK        | Output | O       | <b>SPI Clock.</b> Connect to EEPROM SCK pin.  |
| 49                   | SPI_SD         | SPI_SD         | I/O/Z  | Z       | <b>SPI Dataline Connect to GND</b> with 15 KΩ resistor and to the Data I/O pin of the EEPROM.   |
| <b>Upstream Port</b> |                |                |        |         |   |
| 17                   | D-             | D-             | I/O/Z  | Z       | <b>Upstream D- Signal.</b>  |
| 18                   | D+             | D+             | I/O/Z  | Z       | <b>Upstream D+ Signal.</b>  |



**Table 3. Pin Assignments<sup>[4]</sup>** (continued)

| Pin                      | CY7C65631 Name | CY7C65621 Name | Type   | Default | Description   |
|--------------------------|----------------|----------------|--------|---------|---|
| <b>Downstream Port 1</b> |                |                |        |         |   |
| 13                       | DD-[1]         | DD-[1]         | I/O/Z  | Z       | <b>Downstream D- Signal.</b>  |
| 14                       | DD+[1]         | DD+[1]         | I/O/Z  | Z       | <b>Downstream D+ Signal.</b>  |
| 36                       | AMBER#[1]      | AMBER#[1]      | Output | 1       | <b>LED.</b> Driver output for amber LED. Port indicator support. Default is active LOW. Polarity is controlled through EEPROM.  |
| 35                       | GREEN#[1]      | GREEN#[1]      | Output | 1       | <b>LED.</b> Driver output for green LED. Port indicator Support. Default is Active LOW. Polarity is controlled through EEPROM.  |
| 30                       | OVR#[1]        | OVR#[1]        | Input  | 1       | <b>Overcurrent Condition Detection Input.</b> Default is active LOW. Polarity is controlled through EEPROM.   |
| 29                       | PWR#[1]        | PWR#[1]        | O/Z    | Z       | <b>Power Switch Driver Output.</b> Default is active LOW. Polarity is controlled through EEPROM.  |
| <b>Downstream Port 2</b> |                |                |        |         |   |
| 9                        | DD-[2]         | DD-[2]         | I/O/Z  | Z       | <b>Downstream D- Signal.</b>  |
| 10                       | DD+[2]         | DD+[2]         | I/O/Z  | Z       | <b>Downstream D+ Signal.</b>  |
| 38                       | AMBER#[2]      | AMBER#[2]      | Output | 1       | <b>LED.</b> Driver output for amber LED. Port indicator support. Default is active LOW. Polarity is controlled through EEPROM.  |
| 37                       | GREEN#[2]      | GREEN#[2]      | Output | 1       | <b>LED.</b> Driver output for green LED. Port indicator support. Default is active LOW. Polarity is controlled through EEPROM.  |
| 32                       | OVR#[2]        | OVR#[2]        | Input  | 1       | <b>Overcurrent Condition Detection Input.</b> Default is active LOW. Polarity is controlled through EEPROM.   |
| 31                       | PWR#[2]        | PWR#[2]        | O/Z    | Z       | <b>Power Switch Driver Output.</b> Default is active LOW. Polarity is controlled through EEPROM.  |
| <b>Downstream Port 3</b> |                |                |        |         |   |
| 5                        | DD-[3]         | NC             | I/O/Z  | Z       | <b>Downstream D- Signal.</b>  |
| 6                        | DD+[3]         | NC             | I/O/Z  | Z       | <b>Downstream D+ Signal.</b>  |
| 42                       | AMBER#[3]      | NC             | Output | 1       | <b>LED.</b> Driver output for amber LED. Port indicator support. Default is active LOW. Polarity is controlled through EEPROM.  |
| 41                       | GREEN#[3]      | NC             | Output | 1       | <b>LED.</b> Driver output for green LED. Port indicator support. Default is active LOW. Polarity is controlled through EEPROM.  |
| 53                       | OVR#[3]        | Reserved       | Input  | 1       | <b>Overcurrent Condition Detection Input.</b> Default is Active LOW. Polarity is controlled through EEPROM.<br><b>Reserved.</b> Pull to deasserted state with external resistor on the CY7C65621/31 |
| 54                       | PWR#[3]        | NC             | O/Z    | Z       | <b>Power Switch Driver Output.</b> Default is active LOW. Polarity is controlled through EEPROM.  |
| <b>Downstream Port 4</b> |                |                |        |         |   |
| 1                        | DD-[4]         | NC             | I/O/Z  | Z       | <b>Downstream D- Signal.</b>  |
| 2                        | DD+[4]         | NC             | I/O/Z  | Z       | <b>Downstream D+ Signal.</b>  |
| 44                       | AMBER#[4]      | NC             | Output | 1       | <b>LED.</b> Driver output for amber LED. Port indicator support. Default is active LOW. Polarity is controlled through EEPROM.  |
| 43                       | GREEN#[4]      | NC             | Output | 1       | <b>LED.</b> Driver output for green LED. Port indicator support. Default is active LOW. Polarity is controlled through EEPROM.  |
| 51                       | OVR#[4]        | Reserved       | Input  | 1       | <b>Overcurrent Condition Detection Input.</b> Default is Active LOW. Polarity is controlled through EEPROM.<br><b>Reserved.</b> Pull to deasserted state with external resistor on the CY7C65621/31 |
| 52                       | PWR#[4]        | NC             | O/Z    | Z       | <b>Power Switch Driver Output.</b> Default is active LOW. Polarity is controlled through EEPROM.  |

**Note**

4. Unused port DD+/DD- lines can be left floating. Leave the port power, amber, and green LED pins unconnected, and deassert the overcurrent pin. Do not leave the overcurrent pin floating; it is an input.

## Default Descriptors

This section presents the different descriptors that are available. There is a table for each that lists the functionality of each descriptor.

### Device Descriptor

The standard device descriptor for CY7C65621/31 is based on the information found in the SPI EEPROM. The information in the EEPROM overrides the default descriptor values. If no EEPROM is used, the CY7C65621/31 enumerates with the default descriptor values as shown in the table. If a blank EEPROM is connected, the hub enumerates as vendor defined class instead of a hub class. This is for the purpose of programming the EEPROM with the Cypress driver.

| Byte   | Full Speed | High Speed | Field Name         | Description                                   |
|--------|------------|------------|--------------------|---|
| 0      | 0x12       | 0x12       | bLength            | 18 Bytes                                      |
| 1      | 0x01       | 0x01       | bDescriptorType    | Device_Descriptor                             |
| 2,3    | 0x0110     | 0x0200     | bcdUSB             | USB Specification 2.0 (1.1 if forced FS)      |
| 4      | 0x09       | 0x09       | bDeviceClass       | Hub   |
| 5      | 0x00       | 0x00       | bDeviceSubClass    | None  |
| 6      | 0x00       | 0x01       | bDeviceProtocol    | None  |
| 7      | 0x40       | 0x40       | bMaxPacketSize0    | 64 Bytes                                      |
| 8,9    | 0x04B4     | 0x04B4     | wIdVendor          | VID (overridden by what is defined in EEPROM) |
| 10,11  | 0x6560     | 0x6560     | wIdProduct         | PID (overridden by what is defined in EEPROM) |
| 12, 13 | 0x0915     | 0x0915     | wbcdDevice         | DID (overridden by what is defined in EEPROM) |
| 14     | 0x00       | 0x00       | iManufacturer      | Overridden by EEPROM                          |
| 15     | 0x00       | 0x00       | iProduct           | Overridden by EEPROM                          |
| 16     | 0x00       | 0x00       | iSerialNumber      | Overridden by EEPROM                          |
| 17     | 0x01       | 0x01       | bNumConfigurations | One Configuration Supported                   |

### Configuration Descriptor

| Byte | Full Speed                               | High Speed                               | Field Name          | Description   |
|------|--|--|---------------------|---|
| 0    | 0x09                                     | 0x09                                     | bLength             | 9 bytes   |
| 1    | 0x02 <sup>[5]</sup> /0x07 <sup>[6]</sup> | 0x02 <sup>[5]</sup> /0x07 <sup>[6]</sup> | bDescriptorType     | Config_Descriptor   |
| 2    | 0x0019                                   | 0x0019                                   | wTotalLength        | Length of all other descriptors   |
| 4    | 0x01                                     | 0x01                                     | bNumInterfaces      | 1   |
| 5    | 0x01                                     | 0x01                                     | bConfigurationValue | The configuration to use  |
| 6    | 0x00                                     | 0x00                                     | iConfiguration      |   |
| 7    | 0xA0<br>0xE0                             | 0xA0<br>0xE0                             | bmAttributes        | Value depends on pin 45 - SELFPWR signal<br>SELPWR = 0 yields 0xA0 and =1 yields 0xE0 |
| 8    | 0x28                                     | 0x57 <sup>[5]</sup>                      | bMaxPower           |   |

#### Notes

5. Configured speed descriptor.
6. Other speed descriptor.

**Interface Descriptor**

| Byte | Full Speed | High Speed | Field Name         | Description          |
|------|------------|------------|--------------------|----------------------|
| 0    | 0x09       | 0x09       | bLength            | 9 bytes              |
| 1    | 0x04       | 0x04       | bDescriptorType    | Interface_Descriptor |
| 2    | 0x00       | 0x00       | bInterfaceNumber   |                      |
| 3    | 0x00       | 0x00       | bAlternateSetting  |                      |
| 4    | 0x01       | 0x01       | bNumEndpoints      |                      |
| 5    | 0x09       | 0x09       | bInterfaceClass    |                      |
| 6    | 0x00       | 0x00       | bInterfaceSubClass |                      |
| 7    | 0x00       | 0x00       | bInterfaceProtocol |                      |
| 8    | 0x00       | 0x00       | iInterface         |                      |

**Endpoint Descriptor**

| Byte | Full Speed | High Speed | Field Name       | Description         |
|------|------------|------------|------------------|---------------------|
| 0    | 0x07       | 0x07       | bLength          | 7 Bytes             |
| 1    | 0x05       | 0x05       | bDescriptorType  | Endpoint_Descriptor |
| 2    | 0x81       | 0x81       | bEndpointAddress | IN endpoint #1      |
| 3    | 0x03       | 0x03       | bmAttributes     | Interrupt           |
| 4,5  | 0x0001     | 0x0001     | wMaxPacketSize   | Maximum packet size |
| 6    | 0xFF       | 0x0C       | bInterval        | Polling rate        |

**Device Qualifier Descriptor**

| Byte | Full Speed | High Speed | Field Name         | Description      |
|------|------------|------------|--------------------|------------------|
| 0    | 0x0A       | 0x0A       | bLength            | 10 Bytes         |
| 1    | 0x06       | 0x06       | bDescriptorType    | Device_Qualifier |
| 2,3  | 0x0200     | 0x0200     | bcdUSB             |                  |
| 4    | 0x09       | 0x09       | bDeviceClass       |                  |
| 5    | 0x00       | 0x00       | bDeviceSubClass    |                  |
| 6    | 0x01       | 0x00       | bDeviceProtocol    |                  |
| 7    | 0x40       | 0x40       | bMaxPacketSize0    |                  |
| 8    | 0x01       | 0x01       | bNumConfigurations |                  |
| 9    | 0x00       | 0x00       | bReserved          |                  |

Hub Descriptor

| Byte | All Speed                                  | Field Name          | Description   |
|------|--|---------------------|---|
| 0    | 0x09                                       | bLength             | 9 bytes   |
| 1    | 0x29                                       | bDescriptorType     | Hub descriptor  |
| 2    | 0x04 <sup>[7]</sup><br>0x02                | bNbrPorts           | Number of ports supported, CY7C65631.<br>Number of ports supported, CY7C65621.  |
| 3,4  | 0x0089 <sup>[7]</sup>                      | wHubCharacteristics | b1, b0: Logical power switching mode<br>00: Ganged power switching (all ports' power at once)<br>01: Individual port power switching (Default in CY7C65621/31)<br>b2: Identifies a compound device,<br>0: Hub is not part of a compound device (Default in CY7C65621/31),<br>1: Hub is part of a compound device.<br>b4, b3: Overcurrent protection mode<br>00: Global overcurrent protection. The hub reports overcurrent as a summation of all ports' current draw, without a breakdown of individual port overcurrent status.<br>01: Individual port overcurrent protection. The hub reports overcurrent on a per-port basis. Each port has an over-current status (Default in CY7C65621/31).<br>1X: No overcurrent protection. This option is allowed only for bus powered hubs that do not implement overcurrent protection.<br>b6, b5: TT Think Time<br>00: TT requires at most eight FS bit times of inter transaction gap on a full or low speed downstream bus (Default in CY7C65621/31).<br>b7: Port indicators supported,<br>0: Port indicators are not supported on its downstream facing ports and the SetPortIndicator request has no effect.<br>1: Port indicators are supported on its downstream facing ports and the SetPortIndicator request controls the indicators. See <a href="#">Functional Overview</a> and <a href="#">Supported USB Requests</a> . (Default in CY7C65621/31).<br>b15, b8: Reserved |
| 5    | 0x32 <sup>[7]</sup>                        | bPwrOn2PwrGood      | Time from when the port is powered to when the power is good on that port   |
| 6    | 0x28 <sup>[7]</sup><br>0xAE <sup>[7]</sup> | bHubContrCurrent    | Maximum current requirement for the Hub Controller at full speed.<br>Maximum current requirement for the Hub Controller at high speed.  |
| 7    | 0x00 <sup>[7]</sup>                        | bDeviceRemovable    | Indicates if the logical port has a removable device attached (0 = removable, 1 = non removable)  |
| 8    | 0xFF <sup>[7]</sup>                        | bPortPwrCtrlMask    | Required for compatibility with software written for 1.0 compliant devices  |

Note

7. This value is configured through the external EEPROM.

## Configuration Options

Systems using CY7C65621/31 may have the option of using a fuse ROM which is preset at the factory to configure the hub. Otherwise, it must have an external EEPROM for the device to have a unique VID, PID, and DID. The CY7C65621/31 can communicate with SPI EEPROM that are either double byte addressed or single byte with the 9th bit within the instruction byte, such as the 24LC040 parts use. The 25LC080 EEPROM uses the double byte address format, and therefore the CY7C656xx can communicate with these parts. The '010s and '020s use the same command format as is used to interface with the '040. Therefore, these can also be used to interface with the CY7C65621/31.

If the attached EEPROM is blank (0xFF), the hub enumerates as a vendor class device. In this configuration, the hub connects to the Cypress driver to allow programming of the EEPROM. When the EEPROM is programmed a power cycle configures the chip as a hub class device.

### 0xD0 Load

With this EEPROM format, only a unique VID, PID, and DID must be present in the external SPI EEPROM. The contents of the EEPROM must contain this information in the following format:

| Byte | Value     |
|------|-----------|
| 0    | 0xD0      |
| 1    | VID (LSB) |
| 2    | VID (MSB) |
| 3    | PID (LSB) |
| 4    | PID (MSB) |
| 5    | reserved  |
| 6    | DID (MSB) |

### 0xD2 Load

| Byte | Value (MSB->LSB)   |
|------|--|
| 0    | 0xD2   |
| 1    | VID (LSB)  |
| 2    | VID (MSB)  |
| 3    | PID (LSB)  |
| 4    | PID (MSB)  |
| 5    | reserved   |
| 6    | DID (MSB)  |
| 7    | EnabledOverCurrentTimer[3:0], DisableOvercurrentTimer[3:0]   |
| 8    | ActivePorts[3:0], RemovablePorts[3:0]  |
| 9    | MaxPower   |
| 10   | HubControllerPower   |
| 11   | PowerOnTimer   |
| 12   | IllegalHubDescriptor, CompoundDevice, FullspeedOnly, NoPortIndicators, Reserved, GangPowered, Reserved, Reserved |

### Byte 0: 0xD2

Needs to be programmed with 0xD2

### Byte 1: VID (LSB)

Least Significant Byte of Vendor ID

### Byte 2: VID (MSB)

Most Significant Byte of Vendor ID

### Byte 3: PID (LSB)

Least Significant Byte of Product ID

### Byte 4: PID (MSB)]

Most Significant Byte of Product ID

### Byte 5: Reserved

Reserved

### Byte 6: DID (MSB)]

Most Significant Byte of Device ID

### Byte 7: EnabledOvercurrentTimer[3:0], DisabledOvercurrentTimer[3:0]

Count time in ms for filtering overcurrent detection. Bits 7–4 are for an enabled port, and bits 3–0 are for a disabled port. Both range from 0 ms to 15 ms. See section [Port Indicators](#) on page 5. Default: 8 ms = 0x88.

### Byte 8: ActivePorts[3:0], RemovablePorts[3:0]

Bits 7–4 are the ActivePorts[3:0] bits that indicates if the corresponding port is usable. For example, a two-port hub that uses ports 1 and 4 sets this field to 0x09. The total number of ports reported in the Hub Descriptor: bNbrPorts field is calculated from this. Bits 3–0 are the RemovablePorts[3:0] bits that indicates whether the corresponding logical port is removable (set to high). Logical port numbers are from 1 to n where n is the total number of active ports. If port 2 is disabled then physical ports 1, 3, and 4 map to logical ports 1, 2, and 3. These bit values are reported appropriately in the HubDescriptor:DeviceRemovable field. Default: 0xFF.

### Byte 9: MaximumPower

This value is reported in the ConfigurationDescriptor:bMaxPower field and is the current in 2 mA increments that is required from the upstream hub. Default: 0x28 = 80 mA for full speed and 0x57 = 174 mA for high speed.

### Byte 10: HubControllerPower

This value is reported in the HubDescriptor:bHubContrCurrent field and is the current in milliamperes required by the hub controller. Default: 0x50 = 80 mA for full speed and 0xAE = 174 mA for high speed.

### Byte 11: PowerOnTimer

This value is reported in the HubDescriptor:bPwrOn2PwrGood field and is the time in 2 ms intervals from the SetPortPower command until the power on the corresponding downstream port is good. Default: 0x32 = 100 ms.

**Byte 12: IllegalHubDescriptor, CompoundDevice, Full speedOnly, NoPortIndicators, Reserved, GangPowered, SingleTTOOnly**

Bit 7: IllegalHubDescriptor. For GetHubDescriptor request, some USB hosts use a DescriptorTypeof 0x00 instead of HUB\_DESCRIPTOR, 0x29. According to the USB 2.0 standard, a hub must treat this as a Request Error, and STALL the transaction accordingly (USB 2.0, 11.24.2.5). For systems that do not accept this, the IllegalHubDescriptor configuration bit may be set to allow CY7C65621/31 to accept a DescriptorType of 0x00 for this command. Default is 1.

Bit 6: CompoundDevice. Indicates whether the hub is part of a compound device. This is reported in the HubDescriptor, wHub-Characteristics: b2. Default set to '0'.

Bit 5: Fullspeed. Only configures the hub to be a full speed only device. Default is set to '0'.

Bit 4: NoPortIndicators. Turns off the port indicators and does not report them as present in the HubDescriptor, wHubCharacteristics b7 field. Default is set to '0'.

Bit 3: Reserved. Set this bit to '0'.

Bit 2: GangPowered. Indicates whether the port power switching is ganged (set to 1) or per-port (set to '0'). This is reported in the HubDescriptor, wHubCharacteristics field, b4, b3, b1, and b0. Default is set to '0'.

Bit 1: Reserved. Default is set to '0'.

Bit 0: Reserved. Default is set to '0'.

**0xD4 Load**

| Byte | Value (MSB->LSB)   | Factory Fusible |
|------|--|-----------------|
| 0    | 0xD4   |                 |
| 1    | VID (LSB)  | X               |
| 2    | VID (MSB)  | X               |
| 3    | PID (LSB)  | X               |
| 4    | PID (MSB)  | X               |
| 5    | reserved   |                 |
| 6    | DID (MSB)  | X               |
| 7    | EnabledOverCurrentTimer[3:0], DisableOvercurrentTimer[3:0] |                 |
| 8    | MaxPower (Full speed)                                      | X               |
| 9    | MaxPower (High speed)                                      | X               |
| 10   | Reserved   |                 |
| 11   | Reserved   |                 |
| 12   | HubControllerPower Full Speed Bus Powered                  | X               |
| 13   | HubControllerPower High Speed Bus Powered                  | X               |
| 14   | HubControllerPower Full Speed Self Powered                 |                 |
| 15   | HubControllerPower High Speed Self Powered                 |                 |
| 16   | PowerOnTimer   |                 |

| Byte     | Value (MSB->LSB)  | Factory Fusible |
|----------|---|-----------------|
| 17       | IllegalHubDescriptor, Compound-Device, FullspeedOnly, NoPortIndicators, Reserved, GangPowered, SingleTTOOnly, Reserved          | X               |
| 18       | AmberPolarity, GreenPolarity, ModulateIndicators, PowerControlPolarity, OverCurrentPolarity, OverCurrentMode1, OverCurrentMode2 | X               |
| 19       | Write Protect   |                 |
| 20       | NumLangs  |                 |
| 21       | SupportedStrings  |                 |
| 22       | ActivePorts[3:0]  |                 |
| 23       | RemovablePorts[3:0]   | X               |
| 24       | LangID  |                 |
| a =24+2N | iManufacturer   |                 |
| b =a+2N  | iProduct  |                 |
| c =b+2N  | iSerialNumber   |                 |
| d =c+2N  | iConfiguration(FS)  |                 |
| e =d+2N  | iConfiguration(HS)  |                 |
| f =e+2N  | iInterface(0)   |                 |
| g =f+2N  | reserved  |                 |
| h=g+2N   | Strings   |                 |

N:NumLangs

**Byte 0: 0xD4**

Needs to be programmed with 0xD4

**Byte 1: VID (LSB)**

Least Significant Byte of Vendor ID

**Byte 2: VID (MSB)**

Most Significant Byte of Vendor ID

**Byte 3: PID (LSB)**

Least Significant Byte of Product ID

**Byte 4: PID (MSB)**

Most Significant Byte of Product ID

**Byte 5: Reserved**

Reserved.

**Byte 6: DID (MSB)**

Most Significant Byte of Device ID



**Byte 7: EnabledOvercurrentTimer[3:0], DisabledOvercurrentTimer[3:0]**

Count time in ms for filtering overcurrent detection. Bits 7–4 are for an enabled port, and bits 3–0 are for a disabled port. Both range from 0 ms to 15 ms. See section [Port Indicators](#) on page 5. Default: 8 ms = 0x88.

**Byte 8: MaximumPower (Full Speed)**

This value is reported in the ConfigurationDescriptor:bMaxPower field and is the current in 2 mA increments that is required from the upstream hub when connected at full speed. Default: 0x28 = 80 mA for full speed.

**Byte 9: MaximumPower (High Speed)**

This value is reported in the ConfigurationDescriptor:bMaxPower field and is the current in 2 mA increments that is required from the upstream hub when connected at high speed. Default: 0x57 = 174 mA for high speed.

**Byte 10: Reserved**

Write zeros to this location.

**Byte 11: Reserved**

Write zeros to this location.

**Byte 12: HubControllerPower (Full Speed, bus powered)**

This value is reported in the HubDescriptor:bHubContrCurrent field and is the current in milliamperes required by the hub controller when connected on the upstream hub as a full speed. Default: 0x50 = 80 mA for full speed.

**Byte 13: HubControllerPower (High Speed, bus powered)**

This value is reported in the HubDescriptor:bHubContrCurrent field and is the current in milliamperes required by the hub controller when connected on the upstream hub as a high speed. Default: 0xAE = 174 mA for high speed.

**Byte 14: HubControllerPower (Full Speed, self powered)**

This value is reported in the HubDescriptor:bHubContrCurrent field and is the current in milliamperes required by the hub controller when connected on the upstream hub as a full speed. Default: 0x50 = 80 mA for full speed.

**Byte 15: HubControllerPower (High speed, self powered)**

This value is reported in the HubDescriptor:bHubContrCurrent field and is the current in milliamperes required by the hub controller when connected on the upstream hub as a high speed. Default: 0x64 = 100 mA for high speed.

**Byte 16: PowerOnTimer**

This value is reported in the HubDescriptor:bPwrOn2PwrGood field and is the time in 2 ms increments from the SetPortPower command until the power on the corresponding downstream port is good. Default: 0x32 = 100 ms.

**Byte 17: IllegalHubDescriptor, CompoundDevice, Full speedOnly, NoPortIndicators, Reserved, GangPowered, Reserved**

Bit 7: IllegalHubDescriptor. For GetHubDescriptor request, some USB hosts use a DescriptorTypeof 0x00 instead of HUB\_DESCRIPTOR, 0x29. According to the USB 2.0 standard, a hub must treat this as a Request Error, and STALL the transaction accordingly (USB 2.0, 11.24.2.5). For systems

that do not accept this, the IllegalHubDescriptor configuration bit may be set to allow CY7C65621/31 to accept a DescriptorType of 0x00 for this command. Default set to 1.

Bit 6: CompoundDevice. Indicates whether the hub is part of a compound device. This is reported in the HubDescriptor, wHub-Characteristics: b2. Default is set to '0'.

Bit 5: Fullspeed. Only configures the hub to be a full speed only device. Default is set to '0'.

Bit 4: NoPortIndicators. Turns off the port indicators and does not report them as present in the HubDescriptor, wHubCharacteristics b7 field. Default is set to '0'.

Bit 3: Reserved. Set this bit to '0'.

Bit 2: GangPowered. Indicates whether the port power switching is ganged (set to 1) or per-port (set to '0'). This is reported in the HubDescriptor, wHubCharacteristics field, b4, b3, b1, and b0. Default is set to '0'.

Bit 1: Reserved. Default is set to '0'.

Bit 0: Reserved. Default is set to '0'.

**Byte 18: AmberPolarity, GreenPolarity, SelfPowerable, ModulateIndicators, PowerControlPolarity, OverCurrentPolarity, OverCurrentMode1, OverCurrentMode2**

Bit 7: AmberPolarity. Indicates the polarity of the amber indicator control. (1 = high, 0 = low)

Bit 6: GreenPolarity. Indicates the polarity of the green indicator control. (1 = high, 0 = low)

Bit 5: SelfPowerable. Indicates whether the hub is capable of operating in self-powered mode. If '0', the hub is capable of bus-powered operation only.

Bit 4: ModulateIndicators. If this bit is set, the indicator outputs are modulated by a square wave of 120 Hz, for power savings. If '0', the outputs are static.

Bit 3: PowerControlPolarity. If set, the power control outputs are active HIGH. If not set, the power control outputs are active LOW.

Bit 2: OverCurrentPolarity. If set, the over-current inputs are active HIGH. If not set, the over-current inputs are active LOW.

Bit 1: OverCurrentMode1. Reported as bit 4 of the wHubCharacteristics field of the hub descriptor. If set to '1', this bit disables over-current detection.

Bit 0: OverCurrentMode2. Reported as bit 3 of the wHubCharacteristics field of the hub descriptor. If Bit 1 of this byte is set to '0', over-current detection is enabled. If this bit (Bit 0) is set to '1', the hub reports over-current on a per-port basis. If set to '0', the hub reports over-current as the summation of all ports' current draw.

**Byte 19: Write Protect**

Writing the value 0x42 to this field enables Write Protect and any future writes to the EEPROM will fail. Default is set to '0'.

**Byte 20: NumLangs**

Number of supported string languages. CY7C656xx supports a maximum of 31 languages; if this field is set to '0' or a number larger than 31, all string support is disabled.



**Byte 21: SupportedStrings**

This field contains a bitmap of strings supported by the hub. A set bit indicates that the standard string is supported. A bit not set indicates that the string is not supported. The hub controller returns a non-zero index for each string that is supported, and returns 0x00 for each string not supported, as indicated by this field. The bits in this field correspond to the following standard strings.

**Table 4. Byte 21 Supported Strings**

| Bit | Name           | Description   |
|-----|----------------|---|
| 7   | Reserved       |   |
| 6   | Reserved       |   |
| 5   | Interface (0)  | The iInterface string index reported in the first interface descriptor (alternate setting 0)                        |
| 4   | iConfiguration | (High speed) The iConfiguration string index reported in the configuration descriptor, when operating at high speed |
| 3   | iConfiguration | (Full speed) The iConfiguration string index reported in the configuration descriptor, when operating at full speed |
| 2   | iSerial Number | The iSerialNumber string index reported in the device descriptor  |
| 1   | iProduct       | The iProduct string index reported in the device descriptor   |
| 0   | iManufacturer  | The iManufacturer string index reported in the device descriptor  |

**Byte 22: ActivePorts[3:0]**

Bits 3–0 are the ActivePorts[3:0] bits that indicates if the corresponding port is usable. For example, a two-port hub that uses ports 1 and 4 would set this field to 0x09. The total number of ports reported in the Hub Descriptor: bNbrPorts field is calculated from this. Default 0x0F

**Byte 23: RemovablePorts[3:0]**

Bits 3–0 are the RemovablePorts[3:0] bits that indicates whether the corresponding logical port is removable (set to high). Logical port numbers are from 1 to n where n is the total number of active ports. If port 2 is disabled then physical ports 1, 3, and 4 map to logical ports 1, 2, and 3. These bit values are recorded in the HubDescriptor:DeviceRemovable field. Default 0x0F.

**Byte 24: LangID**

Array of LangID codes supported by the hub. Each LangID consists of two bytes, stored LSB first. The array has NumLangs entries (2 \* NumLangs bytes).

**Byte a: iManufacturer**

Array of addresses for the iManufacturer strings. Each address is two bytes long, stored LSB first. The array has NumLangs entries (2 \* NumLangs bytes). (The starting EEPROM address is based upon the number entered for NumLangs. The address  $a = 24 + 2 * \text{NumLangs}$ .)

**Byte b: iProduct**

Array of addresses for the iProduct strings. Each address is two bytes long, stored LSB first. The array has NumLangs entries (2 \* NumLangs bytes). The address  $b = a + 2 * \text{NumLangs}$ .

**Byte c: iSerialNumber**

Array of addresses for the iSerialNumber strings. Each address is two bytes long, stored LSB first. The array has NumLangs entries (2 \* NumLangs bytes). The address  $c = b + 2 * \text{NumLangs}$ .

**Byte d: iConfiguration(Full Speed)**

Array of addresses for the iConfiguration (full speed) strings. Each address is two bytes long, stored LSB first. The array has NumLangs entries (2 \* NumLangs bytes). The address  $d = c + 2 * \text{NumLangs}$ .

**Byte e: iConfiguration(High Speed)**

Array of addresses for the iConfiguration (high speed) strings. Each address is two bytes long, stored LSB first. The array has NumLangs entries (2 \* NumLangs bytes). The address  $e = d + 2 * \text{NumLangs}$ .

**Byte f: iInterface(0)**

Array of addresses for the iInterface(0) strings. Each address is two bytes long, stored LSB first. The array has NumLangs entries (2 \* NumLangs bytes). The address  $f = e + 2 * \text{NumLangs}$ .

**Byte g: iInterface(1)**

Reserved

**Byte h: Strings**

Strings addressed by the string pointers. Strings must comply with the USB specification. The first byte must be the length of the string in bytes, the second must be 0x03, and the string must be in Unicode.

## Supported USB Requests

### Device Class Commands

Table 5. Device Class Requests

| Request                               | bmRequestType | bRequest | wValue              | wIndex              | wLength           | Data                    |
|---------------------------------------|---------------|----------|---------------------|---------------------|-------------------|-------------------------|
| GetDeviceStatus                       | 10000000B     | 0x00     | 0x0000              | 0x0000              | 0x0002            | 2 Byte Device Status    |
| GetInterfaceStatus                    | 10000001B     | 0x00     | 0x0000              | 0x0000              | 0x0002            | 2 Byte Interface Status |
| GetEndpointStatus                     | 10000010B     | 0x00     | 0x0000              | 0x0000              | 0x0002            | 2 Byte Endpoint Status  |
| GetDeviceDescriptor                   | 10000000B     | 0x06     | 0x0001              | Zero or Language ID | Descriptor Length | Descriptor              |
| GetConfigDescriptor                   | 10000000B     | 0x06     | 0x0002              | Zero or Language ID | Descriptor Length | Descriptor              |
| GetDeviceQualifierDescriptor          | 10000000B     | 0x06     | 0x0006              | Zero or Language ID | Descriptor Length | Descriptor              |
| GetOtherSpeedConfiguration Descriptor | 10000000B     | 0x06     | 0x0007              | Zero or Language ID | Descriptor Length | Descriptor              |
| GetConfiguration <sup>[8]</sup>       | 10000000B     | 0x08     | 0x0000              | 0x0000              | 0x0001            | Configuration Value     |
| SetConfiguration <sup>[8]</sup>       | 00000000B     | 0x09     | Configuration Value | 0x0000              | 0x0000            | None                    |
| GetInterface                          | 10000001B     | 0xA      | 0x0000              | 0x0000              | 0x0001            | Interface Number        |
| SetInterface                          | 00000001B     | 0x0B     | Alternate Setting   | Interface Number    | 0x0000            | None                    |
| SetAddress                            | 00000000B     | 0x05     | Device Address      | 0x0000              | 0x0000            | None                    |
| SetDeviceRemoteWakeup                 | 00000000B     | 0x03     | 0x01                | 0x0000              | 0x0000            | None                    |
| SetDeviceTest_J                       | 00000000B     | 0x03     | 0x02                | 0x0100              | 0x0000            | None                    |
| SetDeviceTest_K                       | 00000000B     | 0x03     | 0x02                | 0x0200              | 0x0000            | None                    |
| SetDeviceTest_SE0_NAK                 | 00000000B     | 0x03     | 0x02                | 0x0300              | 0x0000            | None                    |
| SetDeviceTest_Packet                  | 00000000B     | 0x03     | 0x02                | 0x0400              | 0x0000            | None                    |
| SetEndpointHalt                       | 00000000B     | 0x03     | 0x00                | 0x0000              | 0x0000            | None                    |
| ClearDeviceRemoteWakeup               | 00000000B     | 0x01     | 0x01                | 0x0000              | 0x0000            | None                    |
| ClearEndpointHalt                     | 00000000B     | 0x01     | 0x00                | 0x0000              | 0x0000            | None                    |

**Note**

8. Only one configuration is supported in CY7C656xx.

Hub Class Commands

Table 6. Hub Class Requests

| Request          | bmRequestType | bRequest | wValue  | wIndex   | wLength               | Data   |
|------------------|---------------|----------|---|--|-----------------------|--|
| GetHubStatus     | 10100000B     | 0x00     | 0x0000  | 0x0000   | 0x0004                | Hub status (See Table 11-19 of USB 2.0 Specifications)<br>Change Status (See Table 11-20 of USB 2.0 Specifications)  |
| GetPortStatus    | 10100011B     | 0x00     | 0x0000  | Byte 0: 0x00<br>Byte 1: Port                                     | 0x0004                | Port status (See Table 11-21 of USB 2.0 Specifications)<br>Change Status (See Table 11-20 of USB 2.0 Specifications) |
| ClearHubFeature  | 00100000B     | 0x01     | Feature Selectors <sup>[9]</sup> 0 or 1                         | 0x0000   | 0x0000                | None   |
| ClearPortFeature | 00100011B     | 0x01     | Feature Selectors <sup>[9]</sup> 1, 2, 8, 16, 17, 18, 19, or 20 | Byte 0: 0x00<br>Byte 1: Port                                     | 0x0000                | None   |
| ClearPortFeature | 00100011B     | 0x01     | Feature Selectors <sup>[9]</sup> 22 (PORT_INDICATOR)            | Byte 0: -<br>Byte 1: Port  | 0x0000                | None   |
| SetHubFeature    | 00100000B     | 0x03     | Feature Selector <sup>[9]</sup> 0 or 1                          | 0x0000   | 0x0000                |  |
| SetPortFeature   | 00100011B     | 0x03     | Feature Selectors <sup>[9]</sup> 2, 4 or 8                      | Port   | 0x0000                | None   |
| SetPortFeature   | 00100011B     | 0x03     | Feature Selector <sup>[9]</sup> 21 (PORT_TEST)                  | Byte 0: Selectors <sup>[9]</sup> 1, 2, 3, 4 or 5<br>Byte 1: Port | 0x0000                | None   |
| SetPortFeature   | 00100011B     | 0x03     | Feature Selector <sup>[9]</sup> 22 (PORT_INDICATOR)             | Byte 0: Selectors <sup>[10]</sup> 0, 1, 2, or 3<br>Byte 1: Port  | 0x0000                | None   |
| GetHubDescriptor | 10100000B     | 0x06     | Descriptor Type and Descriptor Index                            |  | Hub Descriptor Length |  |
| ClearTTBuffer    | 00100011B     | 0x08     | Dev_Addr, EP_Num  | TT_Port  | 0x0000                | None   |
| ResetTT          | 00100000B     | 0x09     | 0x0000  | Byte 0: 0x00<br>Byte 1: Port                                     | 0x0000                | None   |
| GetTTState       | 10100011B     | 0X0A     | TT_Flags  | Byte 0: 0x00<br>Byte 1: Port                                     | TT State Length       | TT State   |
| StopTT           | 00100011B     | 0x0B     | 0x0000  | Byte 0: 0x00<br>Byte 1: Port                                     | 0x0000                | None   |

Notes

- 9. Feature selector values for different features are presented in Table 7 on page 19.
- 10. Selector values for different features are presented in Table 9 on page 20.

**Table 6. Hub Class Requests** (continued)

| Request   | bmRequestType | bRequest | wValue | wIndex | wLength | Data |
|---|---------------|----------|--------|--------|---------|------|
| <b>Vendor Commands</b>  |               |          |        |        |         |      |
| Read EEPROM   | 11000000B     | 0x02     | 0x00   | 0x00   | Length  | Data |
| This request results in length bytes of data being read from the external memory device, and returned to the host. Data is read beginning with address 0. This request fails if there is no external memory device present. This request is only valid if the hub is in the Configured state; the request fails otherwise.                                      |               |          |        |        |         |      |
| Write EEPROM  | 01000000B     | 0x01     | 0x00   | 0x00   | Length  | Data |
| This request results in length bytes of data being written to the external memory device. Data is written beginning with address 0. This request fails if there is no external memory device present. This request is only valid if the hub is in the Configured state or if the external memory device write protect byte is set; the request fails otherwise. |               |          |        |        |         |      |

**Table 7. Hub Class Feature Selector**

| Feature Selector    | Recipient | Value |
|---------------------|-----------|-------|
| C_HUB_LOCAL_POWER   | Hub       | 0     |
| C_HUB_OVER_CURRENT  | Hub       | 1     |
| PORT_CONNECTION     | Port      | 0     |
| PORT_ENABLE         | Port      | 1     |
| PORT_SUSPEND        | Port      | 2     |
| PORT_RESET          | Port      | 4     |
| PORT_POWER          | Port      | 8     |
| PORT_LOW_SPEED      | Port      | 9     |
| C_PORT_CONNECTION   | Port      | 16    |
| C_PORT_ENABLE       | Port      | 17    |
| C_PORT_SUSPEND      | Port      | 18    |
| C_PORT_OVER_CURRENT | Port      | 19    |
| C_PORT_RESET        | Port      | 20    |
| PORT_TEST           | Port      | 21    |
| PORT_INDICATOR      | Port      | 22    |

**Table 8. Test Mode Selector for Feature Selector PORT\_TEST (0x21)<sup>[11]</sup>**

| PORT_TEST Mode Description | Selector Value |
|----------------------------|----------------|
| Test_J                     | 1              |
| Test_K                     | 2              |
| Test_SE0_NAK               | 3              |
| Test_Packet                | 4              |
| Test_Force_Enable          | 5              |

**Note**

11. Selector values for different features are presented in Table 8 on page 19.

**Table 9. Port Indicator Selector for Feature Selector PORT\_INDICATOR (0x22)**

| Port Indicator Color                                  | Selector Value | Port Indicator Mode |
|---|----------------|---------------------|
| Color set automatically as shown in Table 1 on page 6 | 0              | Automatic mode      |
| Amber   | 1              | Manual mode         |
| Green   | 2              | Manual mode         |
| Off   | 3              | Manual mode         |

### Upstream USB Connection

The following is a schematic of the USB upstream connector.

**Figure 2. USB Upstream Port Connection**

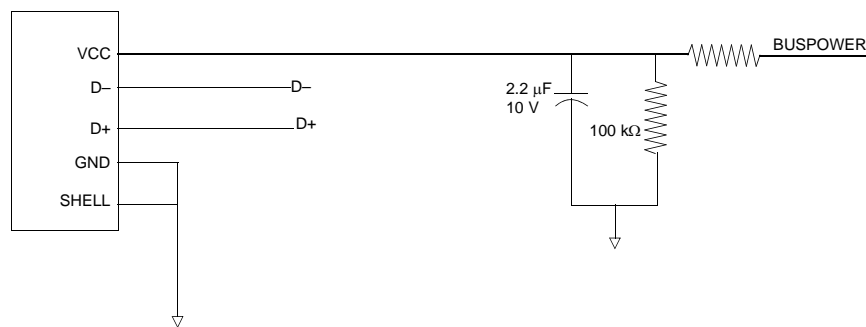

### Downstream USB Connections

The following is a schematic of the USB downstream connector.

**Figure 3. USB Downstream Port Connection**

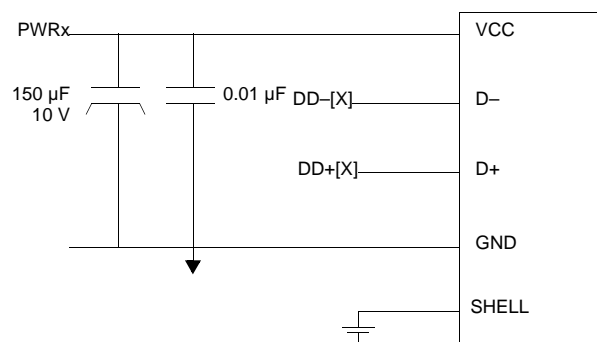

### LED Connections

The following is a schematic of the LED circuitry.

**Figure 4. USB Downstream Port Connection**

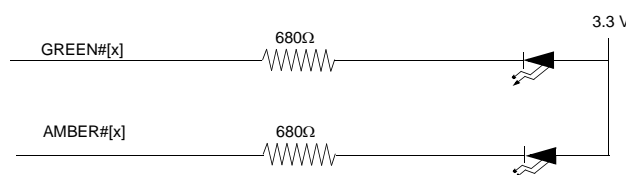

## System Block Diagram

Figure 5. Sample Schematic for 4-Port Self Powered Configuration

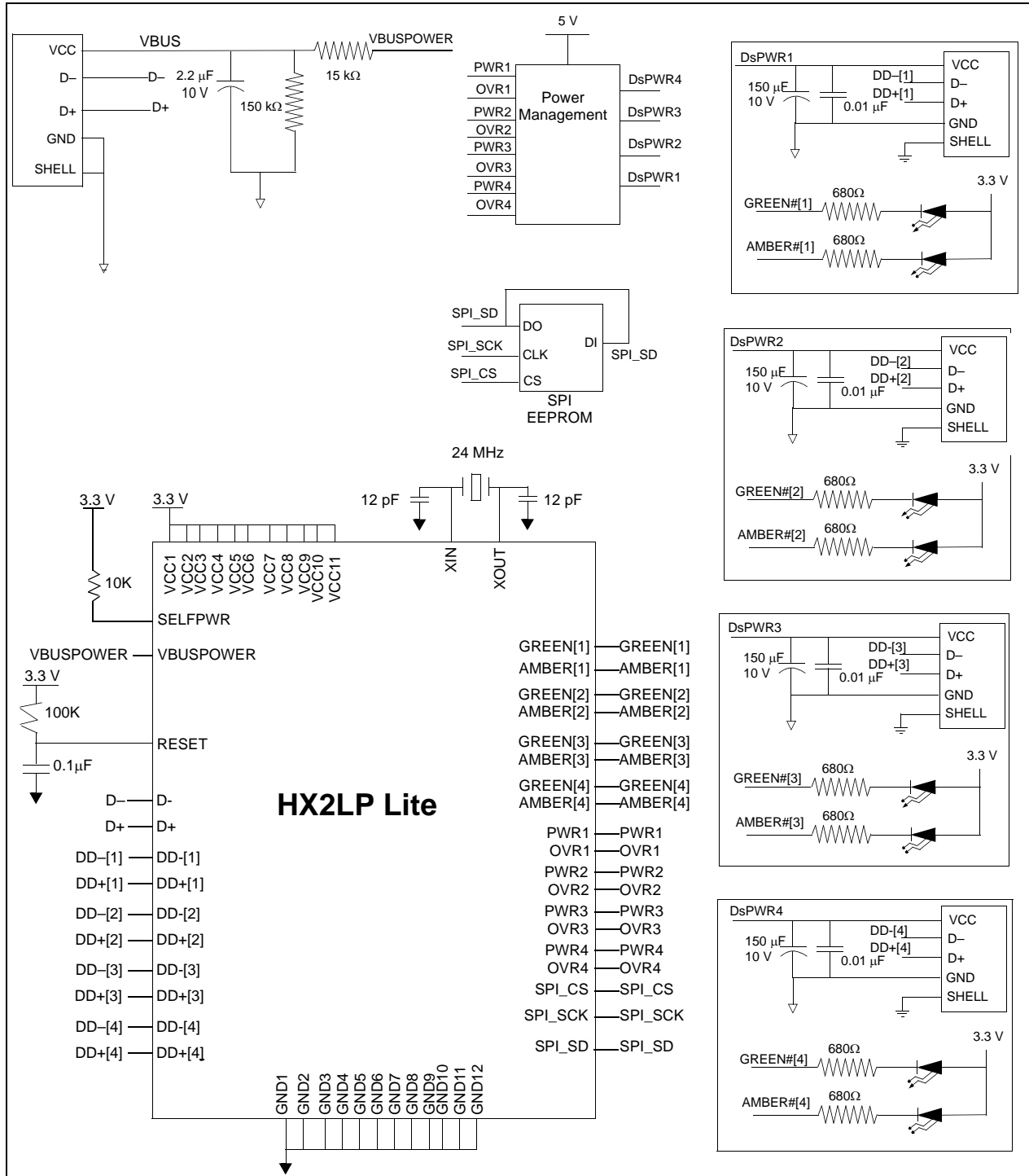

## Electrical Characteristics

### Absolute Maximum Ratings

Storage temperature ..... -65 °C to +150 °C  
 Ambient temperature with power applied:  
 Commercial ..... 0 °C to +70 °C  
 Supply voltage to ground potential ..... -0.5 V to +4.0 V  
 DC voltage applied to outputs  
 in high Z State ..... -0.5 V to  $V_{CC} + 0.5 V$   
 Power dissipation (4 HS ports) ..... 0.9 W  
 Static discharge voltage ..... > 2000 V  
 Maximum output sink current per I/O ..... 10 mA

### Operating Conditions

$T_A$  (Ambient temperature under bias)  
 Commercial ..... 0 °C to +70 °C  
 Supply voltage ..... +3.15 V to +3.45 V  
 Ground voltage ..... 0 V  
 Oscillator or Crystal Frequency (FOSC) ..... 24 MHz  $\pm$  0.05%  
 parallel resonant, 12 pF load capacitance, 0.5 mW

### DC Electrical Characteristics

| Parameter       | Description           | Conditions                          | Min  | Typ | Max      | Unit    |
|-----------------|-----------------------|-------------------------------------|------|-----|----------|---------|
| $V_{CC}$        | Supply voltage        |                                     | 3.15 | 3.3 | 3.45     | V       |
| $V_{CC}$ RampUp | Ramp rate on $V_{CC}$ |                                     |      |     | 18       | V/ms    |
| $V_{IH}$        | Input high voltage    |                                     | 2    |     | 5.25     | V       |
| $V_{IL}$        | Input low voltage     |                                     | -0.5 |     | 0.8      | V       |
| $I_I$           | Input leakage current | $0 < V_{IN} < V_{CC}$               |      |     | $\pm 10$ | $\mu A$ |
| $V_{OH}$        | Output voltage high   | $I_{OUT} = 4 \text{ mA}$            | 2.4  |     |          | V       |
| $V_{OL}$        | Output low voltage    | $I_{OUT} = -4 \text{ mA}$           |      |     | 0.4      | V       |
| $I_{OH}$        | Output current high   |                                     |      |     | 4        | mA      |
| $I_{OL}$        | Output current low    |                                     |      |     | 4        | mA      |
| $C_{IN}$        | Input pin capacitance |                                     |      |     | 10       | pF      |
| $I_{SUSP}$      | Suspend current       |                                     |      | 80  |          | $\mu A$ |
| $I_{CC}$        | <b>Supply Current</b> |                                     |      |     |          |         |
|                 | 4 Active Ports        | Full speed host, full speed devices |      | 86  | 110      | mA      |
|                 |                       | High speed host, high speed devices |      | 231 | 260      | mA      |
|                 |                       | High speed host, full speed devices |      | 154 | 180      | mA      |
|                 | 2 Active Ports        | Full speed host, full speed devices |      | 77  | 100      | mA      |
|                 |                       | High speed host, high speed devices |      | 163 | 190      | mA      |
|                 |                       | High speed host, Full speed devices |      | 136 | 160      | mA      |
|                 | No Active Ports       | Full speed host                     |      | 65  | 90       | mA      |
|                 |                       | High speed host                     |      | 93  | 120      | mA      |

### USB Transceiver

USB 2.0 certified in full, low, and high speed modes.

### AC Electrical Characteristics

Both the upstream USB transceiver and all four downstream transceivers have passed the USB-IF USB 2.0 Electrical Certification Testing.





### Package Diagram

The CY7C65621/31 is available in a space saving 56-pin QFN (8 × 8 mm).

**Figure 6. 56-Pin QFN (8 × 8 × 0.90 mm)**

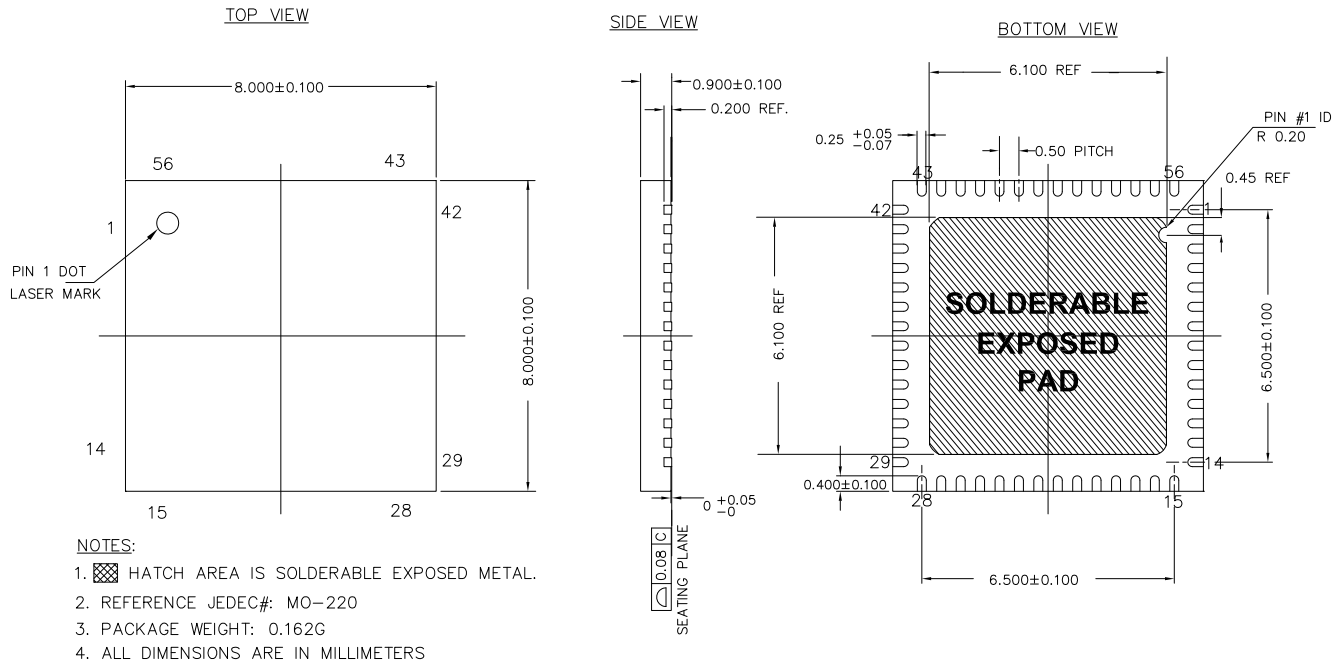

51-85187 \*E

## Acronyms

**Table 11. Acronyms Used in this Document**

| Acronym | Description                             |
|---------|---|
| ASIC    | application specific integrated circuit |
| CPU     | central processing unit                 |
| DSP     | digital signal processor                |
| ECC     | error correcting codes                  |
| GPIF    | general programmable interface          |
| GPIO    | general purpose I/O                     |
| IC      | integrated circuit                      |
| ICE     | in-circuit emulator                     |
| I/O     | input/output                            |
| LSb     | least-significant bit                   |
| LVD     | low voltage detect                      |
| MSb     | most-significant bit                    |
| PLL     | phase locked loop                       |
| PCB     | printed circuit board                   |
| POR     | power on reset                          |
| PSoC®   | Programmable System-on-Chip             |
| SCL     | serial clock                            |
| SDA     | serial data line                        |
| SPI     | serial peripheral interface             |
| RAM     | random access memory                    |
| USB     | universal serial bus                    |
| USB-IF  | USB implementor's forum                 |

## Document Conventions

### Units of Measure

**Table 12. Units of Measure**

| Symbol | Unit of Measure |
|--------|-----------------|
| KHz    | kilohertz       |
| MHz    | megahertz       |
| uA     | microamperes    |
| mA     | milliamperes    |
| ms     | milliseconds    |
| mW     | milliwatts      |
| ns     | nanosecond      |
| pF     | picoFarads      |
| V      | volts           |

Document History Page

| Document Title: CY7C65621/31 EZ-USB HX2LP Lite™ Low Power USB 2.0 Hub Controller Family<br>Document Number: 001-52934 |         |                 |                 |  |
|---|---------|-----------------|-----------------|--|
| Revision  | ECN     | Orig. of Change | Submission Date | Description of Change  |
| **  | 2683316 | OGC/PYRS        | 04/15/2009      | New Data Sheet for CY7C65621/31  |
| *A  | 2937054 | STVC            | 05/25/2010      | Rearranged parts under <a href="#">Ordering Information</a> in alphabetical order.<br>Deleted Figure 7: QFN 8x8mm LF56A with 6.1x6.1 EPAD diagram<br>Updated <a href="#">Package Diagram</a> .<br>Updated description for Pins 51 and 53.<br>Updated links in <a href="#">Sales, Solutions, and Legal Information</a> .<br>Updated table formats.          |
| *B  | 2953993 | DSG             | 06/16/2010      | Removed inactive parts from <a href="#">Ordering Information</a> .   |
| *C  | 3180356 | ODC             | 02/23/2011      | Removed automotive references from the datasheet since the parts are no longer active. This includes "Automotive AEC grade option (-40 °C to +85 °C)" in Features section and "Automotive -40 °C to +85 °C" which appears twice in Electrical characteristics section.<br>Added ordering code definitions and units of measure table.<br>Template updates. |

## Sales, Solutions, and Legal Information

### Worldwide Sales and Design Support

Cypress maintains a worldwide network of offices, solution centers, manufacturer's representatives, and distributors. To find the office closest to you, visit us at [Cypress Locations](#).

### Products

|                          |  |
|--------------------------|--|
| Automotive               | <a href="http://cypress.com/go/automotive">cypress.com/go/automotive</a>   |
| Clocks & Buffers         | <a href="http://cypress.com/go/clocks">cypress.com/go/clocks</a>   |
| Interface                | <a href="http://cypress.com/go/interface">cypress.com/go/interface</a>   |
| Lighting & Power Control | <a href="http://cypress.com/go/powerpsoc">cypress.com/go/powerpsoc</a><br><a href="http://cypress.com/go/plc">cypress.com/go/plc</a> |
| Memory                   | <a href="http://cypress.com/go/memory">cypress.com/go/memory</a>   |
| Optical & Image Sensing  | <a href="http://cypress.com/go/image">cypress.com/go/image</a>   |
| PSoC                     | <a href="http://cypress.com/go/psoc">cypress.com/go/psoc</a>   |
| Touch Sensing            | <a href="http://cypress.com/go/touch">cypress.com/go/touch</a>   |
| USB Controllers          | <a href="http://cypress.com/go/USB">cypress.com/go/USB</a>   |
| Wireless/RF              | <a href="http://cypress.com/go/wireless">cypress.com/go/wireless</a>   |

### PSoC® Solutions

[psoc.cypress.com/solutions](http://psoc.cypress.com/solutions)

PSoC 1 | PSoC 3 | PSoC 5

---

© Cypress Semiconductor Corporation, 2009-2011. The information contained herein is subject to change without notice. Cypress Semiconductor Corporation assumes no responsibility for the use of any circuitry other than circuitry embodied in a Cypress product. Nor does it convey or imply any license under patent or other rights. Cypress products are not warranted nor intended to be used for medical, life support, life saving, critical control or safety applications, unless pursuant to an express written agreement with Cypress. Furthermore, Cypress does not authorize its products for use as critical components in life-support systems where a malfunction or failure may reasonably be expected to result in significant injury to the user. The inclusion of Cypress products in life-support systems application implies that the manufacturer assumes all risk of such use and in doing so indemnifies Cypress against all charges.

Any Source Code (software and/or firmware) is owned by Cypress Semiconductor Corporation (Cypress) and is protected by and subject to worldwide patent protection (United States and foreign), United States copyright laws and international treaty provisions. Cypress hereby grants to licensee a personal, non-exclusive, non-transferable license to copy, use, modify, create derivative works of, and compile the Cypress Source Code and derivative works for the sole purpose of creating custom software and or firmware in support of licensee product to be used only in conjunction with a Cypress integrated circuit as specified in the applicable agreement. Any reproduction, modification, translation, compilation, or representation of this Source Code except as specified above is prohibited without the express written permission of Cypress.

Disclaimer: CYPRESS MAKES NO WARRANTY OF ANY KIND, EXPRESS OR IMPLIED, WITH REGARD TO THIS MATERIAL, INCLUDING, BUT NOT LIMITED TO, THE IMPLIED WARRANTIES OF MERCHANTABILITY AND FITNESS FOR A PARTICULAR PURPOSE. Cypress reserves the right to make changes without further notice to the materials described herein. Cypress does not assume any liability arising out of the application or use of any product or circuit described herein. Cypress does not authorize its products for use as critical components in life-support systems where a malfunction or failure may reasonably be expected to result in significant injury to the user. The inclusion of Cypress' product in a life-support systems application implies that the manufacturer assumes all risk of such use and in doing so indemnifies Cypress against all charges.

Use may be limited by and subject to the applicable Cypress software license agreement.

Document #: 001-52934 Rev. \*C

Revised February 23, 2011

Page 27 of 27

Windows is a registered trademark of Microsoft Corporation. TetraHub and EZ-USB HX2LP Lite are trademarks of Cypress Semiconductor Corporation. All other product and company names mentioned in this document are trademarks of their respective holders.