

## 2.4W Stereo Audio Power Amplifier (with Gain Setting) & Capfree Headphone Driver

### Features

- **Operating Voltage**
  - $HV_{DD} = 3.0\sim 3.6V$
  - $V_{DD} = 4.5\sim 5.5V$
- **No Output Capacitor at Headphone Amplifier Required**
- **Meeting VISTA Requirement**
- **Low Distortion**
  - AMP mode**
    - THD+N=56dB, at  $V_{DD} = 5V$ ,  $R_L = 4W$ ,  $P_o=1.5W$
    - THD+N=64dB, at  $V_{DD} = 5V$ ,  $R_L = 8W$ ,  $P_o=0.9W$
  - HP mode**
    - THD+N=73dB, at  $HV_{DD}=3.3V$ ,  $R_L=16W$   
 $P_o=125mW$
    - THD+N=77dB, at  $HV_{DD}=3.3V$ ,  $R_L=32W$ ,  
 $P_o=88mW$
    - THD+N=85dB, at  $HV_{DD}=3.3V$ ,  $R_L=10kW$ ,  
 $V_o=1.7Vrms$
- **Output Power at 1% THD+N**
  - 1.9W, at  $V_{DD} = 5V$ , AMP mode,  $R_L = 4W$
  - 1.2W, at  $V_{DD} = 5V$ , AMP mode,  $R_L = 8W$
- **at 10% THD+N**
  - 2.4W at  $V_{DD} = 5V$ , AMP mode,  $R_L = 4W$
  - 1.5W at  $V_{DD} = 5V$ , AMP mode,  $R_L = 8W$
- **Depop Circuitry Integrated**
- **Internal 19-steps Gain Setting for Flexible Application**
- **Thermal Shutdown Protection and Over Current Protection Circuitry**
- **High Supply Voltage Ripple Rejection**
- **Surface-Mount Packaging**
  - TSSOP-28P (with enhanced thermal pad)
  - TQFN5x5-28 (with enhanced thermal pad)
- **Lead Free Available (RoHS Compliant)**

### General Description

The APA2057A is a monolithic integrated circuit, which combines a stereo power amplifier and a stereo output capacitor-less headphone amplifier. The stereo power amplifier provides 19-steps gain setting for flexible application. The headphone amplifier is ground-reference output, and no need the output capacitors for DC blocking. The advantages of eliminating the output capacitor are saving the cost, PCB's space and component height.

Both the de-pop circuitry and the thermal shutdown protection circuitry are integrated in the APA2057A, which reduces pops and clicks noise during power on/off and in shutdown mode. Thermal shutdown protects the chip from being destroyed by over-temperature failure. To simplify the audio system design in notebook computer applications, the APA2057A provides the internal gain setting, and these features can minimize components and PCB area.

The APA2057A is available in both TSSOP-28P and TQFN5x5-28 packages. Both packages are characterized by space saving and thermal efficiency.

### Applications

- **Note book PCs**
- **LCD monitor**

ANPEC reserves the right to make changes to improve reliability or manufacturability without notice, and advise customers to obtain the latest version of relevant information to verify before placing orders.

## Ordering and Marking Information

APA2057A	Package Code R : TSSOP-28P    QB : TQFN5x5-28 Operating Ambient Temperature Range I : -40 to 85°C Handling Code TR : Tape & Reel Lead Free Code L : Lead Free Device
APA2057A R :	XXXXX - Date Code
APA2057A QB :	XXXXX - Date Code

Note: ANPEC lead-free products contain molding compounds/die attach materials and 100% matte tin plate termination finish; which are fully compliant with RoHS and compatible with both SnPb and lead-free soldering operations. ANPEC lead-free products meet or exceed the lead-free requirements of IPC/JEDEC J STD-020C for MSL classification at lead-free peak reflow temperature.

## Pin Configurations

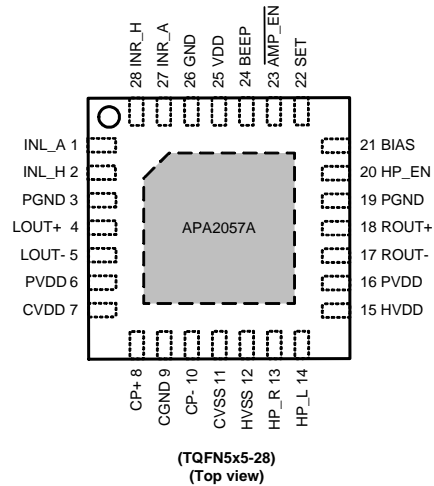
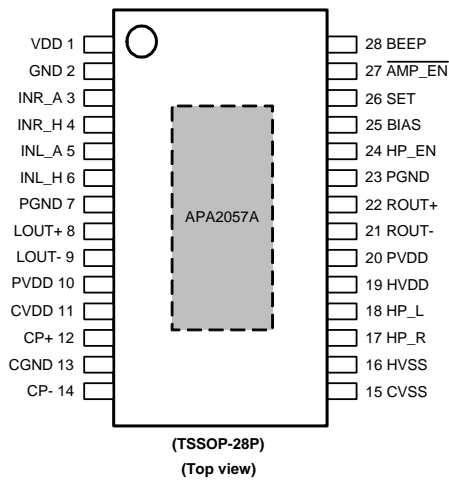

= ThermalPad (connected the ThermalPad to GND plane for better heat dissipation)

## Absolute Maximum Ratings (Note 1)

(Over operating free-air temperature range unless otherwise noted.)

Symbol	Parameter	Rating	Unit
V <sub>DD</sub>	Supply Voltage (PVDD, CVDD, VDD)	-0.3 to 6	V
HV <sub>DD</sub>	Supply Voltage (HVDD)		
V <sub>SS</sub>	Supply Voltage (VSS)	+0.3 to -6	V
V <sub>SET</sub> , V <sub>AMP_EN</sub> , V <sub>HP_EN</sub>	Input Voltage	0 to V <sub>DD</sub> +0.3V	
T <sub>A</sub>	Operating Ambient Temperature Range	-40 to 85	°C
T <sub>J</sub>	Maximum Junction Temperature	150	°C

## Absolute Maximum Ratings (Cont.) (Note 1)

(Over operating free-air temperature range unless otherwise noted.)

Symbol	Parameter	Rating	Unit
T <sub>STG</sub>	Storage Temperature Range	-65 to +150	°C
T <sub>SDR</sub>	Maximum Lead Soldering Temperature	260, 10 seconds	°C
P <sub>D</sub>	Power Dissipation	Internally Limited	W

Note 1 : Absolute Maximum Ratings are those values beyond which the life of a device may be impaired. Exposure to absolute maximum rating conditions for extended periods may affect device reliability.

## Thermal Characteristics (Note 2)

Symbol	Parameter	Value	Unit
$\theta_{JA}$	Thermal Resistance - Junction to Ambient (Note 2)		°C/W
	TSSOP-28P	45	
	TQFN5x5-28	43	

Note 2 : 3.42 in<sup>2</sup> printed circuit board with 20Z trace and copper through 10 vias of 15mil diameter vias. The thermal pad on the TSSOP-28P & TQFN-28 packages with solder on the printed circuit board.

## Recommended Operating Conditions

		Min.	Max.	Unit
Supply voltage, V <sub>DD</sub>		4.5	5.5	V
Supply voltage, HV <sub>DD</sub>		3.0	3.6	V
High level threshold voltage, V <sub>IH</sub>	AMP_EN, HP_EN	2		V
Low level threshold voltage, V <sub>IL</sub>	AMP_EN, HP_EN		0.8	V
Common mode input voltage, Vicm	for Amplifier		V <sub>DD</sub> -1	V
	for Headphone Amplifier		HV <sub>DD</sub> -1	V
Input Voltage (V <sub>SET</sub> )	Shutdown		0.8	
	Gain Setting	2	4.2	V
	Fix Gain	4.5		V

## Electrical Characteristics

V<sub>DD</sub> = 5V, HV<sub>DD</sub> = 3.3V, GND = PGND = CPGND = 0V, T<sub>A</sub> = 25°C (unless otherwise noted).

Symbol	Parameter	Test Condition	APA2057A			Unit
			Min.	Typ.	Max.	
V <sub>DD</sub>	Supply Voltage		4.5		5.5	V
HV <sub>DD</sub>	Headphone Amplifier supply voltage		3.0		3.6	V
I <sub>VDD</sub>	V <sub>DD</sub> Supply Current	Only Speaker mode, AMP_EN = HP_EN = 0V		17.5	29	mA
I <sub>HVDD</sub>	HV <sub>DD</sub> Supply Current			0.15	1	
I <sub>VDD</sub>	V <sub>DD</sub> Supply Current	Only Headphone mode, HP_EN = AMP_EN = 5V		12	20	
I <sub>HVDD</sub>	HV <sub>DD</sub> Supply Current			3	5	
I <sub>VDD</sub>	V <sub>DD</sub> Supply Current	All Enable, HP_EN=5V and AMP_EN = 0V		20	35	
I <sub>HVDD</sub>	HV <sub>DD</sub> Supply Current			3	5	

## Electrical Characteristics (Cont.)

$V_{DD} = 5V$ ,  $HV_{DD} = 3.3V$ ,  $GND = PGND = CPGND = 0V$ ,  $T_A = 25^\circ C$  (unless otherwise noted).

Symbol	Parameter	Test Condition	APA2057A			Unit
			Min.	Typ.	Max.	
$I_{SD(HVDD)}$	$HV_{DD}$ Shutdown Current	SET = 0V		50	90	$\mu A$
$I_{SD(VDD)}$	$V_{DD}$ Shutdown Current			1	10	
$I_{AMP\_EN}$	Input current	$\overline{AMP\_EN}$		1		$\mu A$
$I_{HP\_EN}$	Input current	HP_EN,		10	15	$\mu A$
<b>Speaker mode</b>						
$P_O$	Output Power	THD+N = 1%, $F_{in} = 1KHz$ $R_L = 4\Omega$ $R_L = 8\Omega$	1.0	1.9 1.2		W
		THD+N = 10%, $F_{in} = 1KHz$ $R_L = 4\Omega$ $R_L = 8\Omega$	1.3	2.4 1.5		
$V_{OS}$	Output Offset Voltage	$R_L = 8\Omega$ , Gain = 10.5dB			10	mV
THD+N	Total Harmonic Distortion plus Noise	$F_{in} = 1KHz$ $P_O = 1.5W$ , $R_L = 4\Omega$ $P_O = 0.9W$ , $R_L = 8\Omega$		0.15 0.06		%
X'talk	Channel Separation	$F_{in} = 1KHz$ , $C_B = 2.2\mu F$ , $R_L = 8\Omega$ , $P_O = 0.92W$		80		dB
		$F_{in} = 1KHz$ , $C_B = 2.2\mu F$ , $R_L = 4\Omega$ , $P_O = 1.5W$		83		
PSRR	Power Supply Rejection Ratio	$C_B = 2.2\mu F$ , $R_L = 8\Omega$ , $F_{in} = 120Hz$		70		dB
S/N		$P_O = 0.8W$ , $R_L = 8\Omega$ , A-weighted Filter		90		dB
$V_n$	Noise Output Voltage	Gain = 10.5dB, $R_L = 8\Omega$ , $C_B = 2.2\mu F$		80		$\mu V$ (rms)
<b>Headphone mode</b>						
$P_o$	Output Power	THD+N = 1%, $F_{in} = 1KHz$ $R_L = 16\Omega$ $R_L = 32\Omega$	100	160 120		mW
		THD+N = 10%, $F_{in} = 1KHz$ $R_L = 16\Omega$ $R_L = 32\Omega$	150	200 165		
$V_o$	Output Voltage Swing	$R_L = 10K\Omega$	THD+N=10%	2.9		$V_{rms}$
			THD+N=1%	2.4		
$V_{OS}$	Output Offset Voltage	$R_L = 32\Omega$	-10		+10	mV
THD+N	Total Harmonic Distortion plus Noise	$F_{in} = 1KHz$ $P_O = 125mW$ , $R_L = 16\Omega$ $P_O = 88mW$ , $R_L = 32\Omega$ $V_O = 1.7V_{rms}$ , $R_L = 10k\Omega$		0.02 0.02 0.005		%
X'talk	Channel Separation	$F_{in} = 1KHz$ , $R_L = 16\Omega$ , $P_O = 125mW$		80		dB
		$F_{in} = 1KHz$ , $R_L = 32\Omega$ , $P_O = 88mW$		85		
		$F_{in} = 1KHz$ , $R_L = 10K\Omega$ , $V_O = 1.7V_{rms}$		105		
PSRR	Power Supply Rejection Ratio	$C_B = 2.2\mu F$ , $R_L = 32\Omega$ , $F_{in} = 120Hz$		80		dB

## Electrical Characteristics (Cont.)

$V_{DD} = 5V$ ,  $HV_{DD} = 3.3V$ ,  $GND = PGND = CPGND = 0V$ ,  $T_A = 25^\circ C$  (unless otherwise noted).

Symbol	Parameter	Test Condition	APA2057A			Unit
			Min.	Typ.	Max.	
<b>Headphone mode (Cont.)</b>						
S/N		With A-weighted Filter $P_O = 70mW$ , $R_L = 32\Omega$ $V_O = 1.2V_{rms}$ , $R_L = 10k\Omega$		95 92		dB
$V_n$	Noise Output Voltage	$C_B = 2.2\mu F$		30		$\mu V$ (rms)
$R_f$	Input Feedback Resistance		38	40	42	$k\Omega$
<b>Charge Pump</b>						
Fosc	Switching frequency		460	540	620	KHz
$CV_{SS}$	Charge Dump Output Voltage (CVSS)	No load		-0.98 $V_{DD}$		V
$R_{eq}$	Charge pump requirement resistance			9	12	$\Omega$
<b>Beep</b>						
$V_{beep}$	Beep trigger level			3		$V_{PP}$
$T_{RES}$	Beep response time			4		ms
<b>Attenuation</b>						
Att(HP_EN)	HP disable attenuation	$R_L = 32\Omega$ , $V_O = 1.1V_{rms}$ , $F_{in} = 1KHz$		115		dB
		$R_L = 10K\Omega$ , $V_O = 1.1V_{rms}$ , $F_{in} = 1KHz$		85		dB
Att(AMP_EN)	AMP disable attenuation	$R_L = 8\Omega$ , $V_O = 2V_{rms}$ , $F_{in} = 1KHz$		112		dB
		$R_L = 4\Omega$ , $V_O = 2V_{rms}$ , $F_{in} = 1KHz$		112		dB
Att_SD(HP_EN)	Shutdown active	$R_L = 10K\Omega$ on the Headphone Mode, $V_O = 1.1V_{rms}$ , $F_{in} = 1KHz$		90		dB
Att_SD(AMP_EN)	Shutdown active	$R_L = 8\Omega$ on the AMP Mode, $V_O = 1V_{rms}$ , $F_{in} = 1KHz$		100		dB
<b>Headphone to Speaker Crosstalk</b>						
X'talk	Channel Separation	$\overline{AMP\_EN} = 0V$ , $R_L = 8\Omega$		85		dB
		$HP\_EN = 5V$ , $R_L = 16\Omega$ , $F_{in} = 1KHz$ , $P_O = 125mW$				
<b>Speaker to Headphone Crosstalk</b>						
X'talk	Channel Separation	$HP\_EN = 5V$ , $R_L = 10K\Omega$		80		dB
		$\overline{AMP\_EN} = 0V$ , $R_L = 4\Omega$ , $F_{in} = 1KHz$ , $P_O = 1.5W$				
<b>Amplifier Start up Time</b>						
$T_{start-up}$	Start up time			120		msec

Gain Setting Table \_AMP Mode

(V<sub>DD</sub>=5V)

Gain (dB)	Input Voltage (V <sub>SET</sub> )		Hysteresis (mV)	Recommended Voltage (V)
	Low (V)	High (V)		
-70	0	2.00	SD	0.00
-7	2.04	2.12	47	2.08
-5	2.15	2.24	36	2.20
-3	2.28	2.35	41	2.31
-1	2.39	2.47	41	2.43
1	2.51	2.58	35	2.54
3	2.62	2.70	41	2.66
4	2.74	2.81	48	2.78
5	2.86	2.92	43	2.89
6	2.97	3.04	47	3.01
7	3.09	3.15	45	3.12
8	3.21	3.27	54	3.24
9	3.33	3.39	59	3.36
10	3.45	3.51	64	3.48
11	3.56	3.62	53	3.59
12	3.68	3.73	59	3.70
13	3.80	3.85	66	3.82
14	3.92	3.96	69	3.94
15	4.02	4.07	64	4.05
16	4.15	4.17	76	4.16
10.5	4.26	5.00	94	5.00

Recommend Resistance's Value for Gain Setting

Gain (dB)	R1 (1%)	R# (1%)
-70	10K	0
-7	18K	13K
-5	20K	16K
-3	18K	16K
-1	16K	15K
1	15K	16K
3	13K	15K
4	24K	30K
5	13K	18K
6	13K	20K
7	13K	22K
8	16K	30K
9	13K	27K
10	13K	30K
11	15K	39k
12	13K	39K
13	13K	43K
14	13K	50K
15	15K	68K
16	13K	68K
10.5	10K	>90K

Typical Operating Characteristics

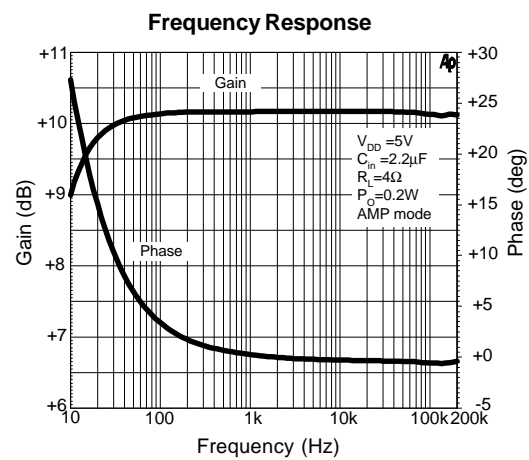
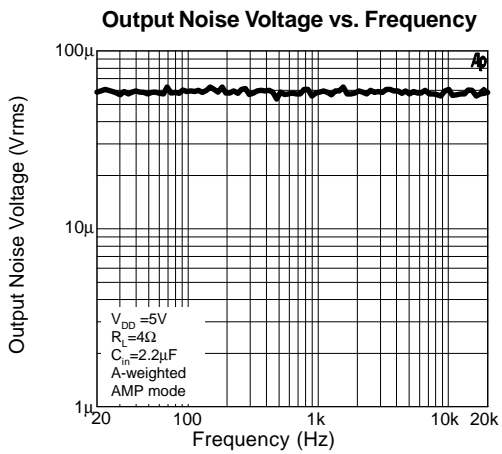
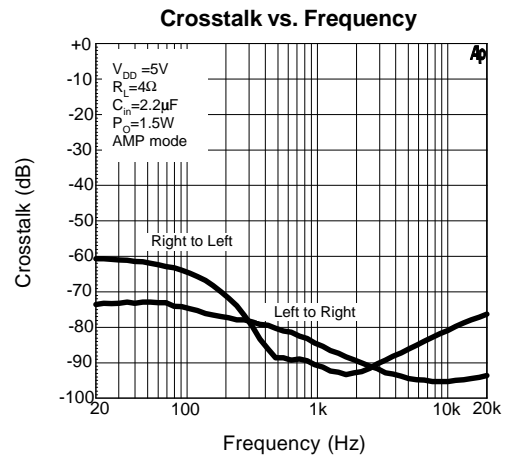
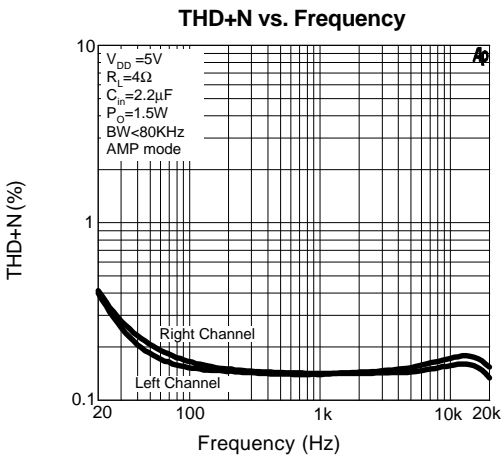
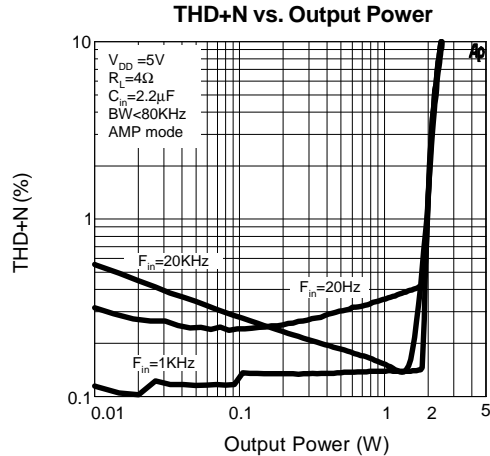
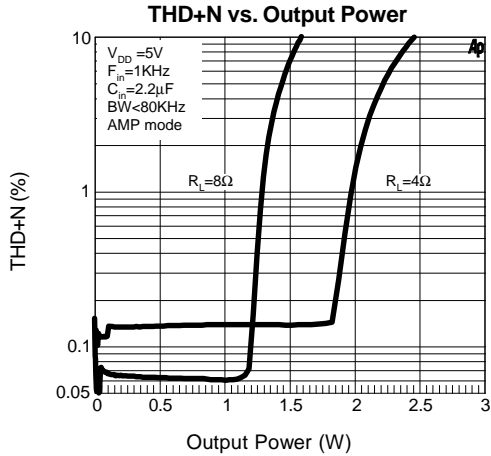

Typical Operating Characteristics (Cont.)

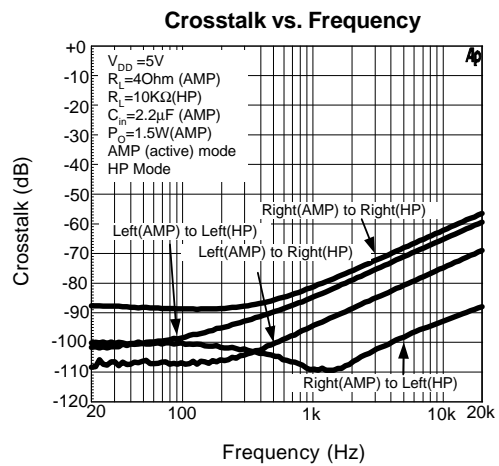
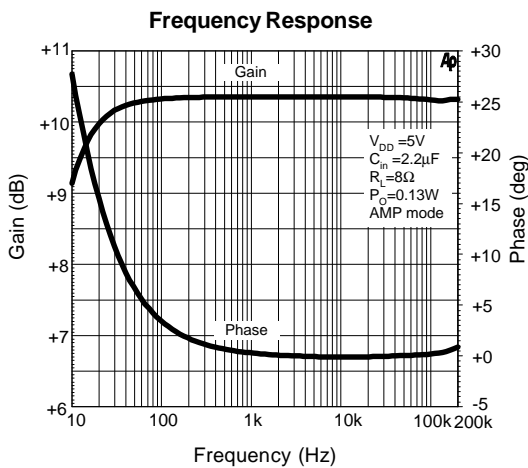
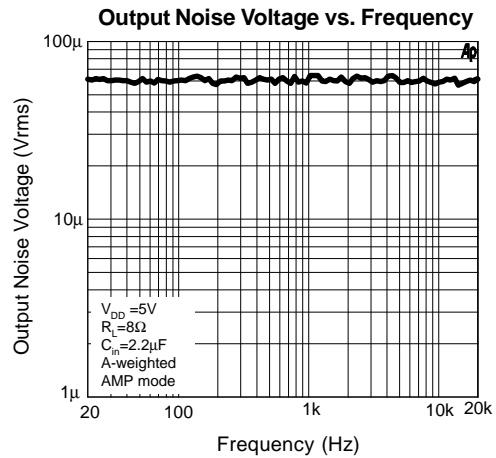
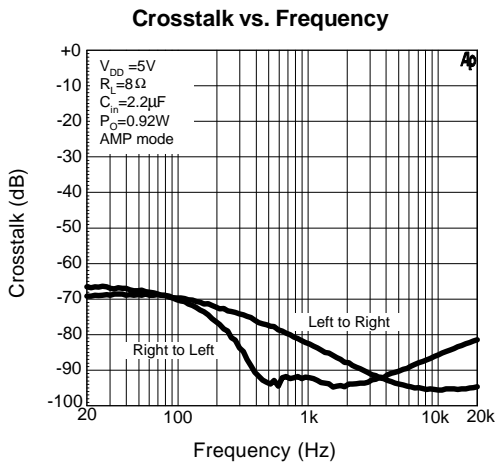
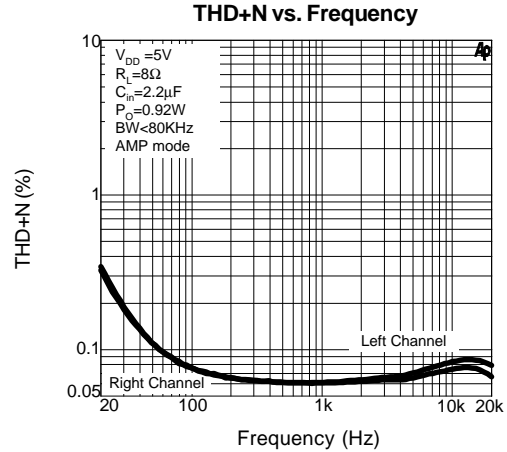
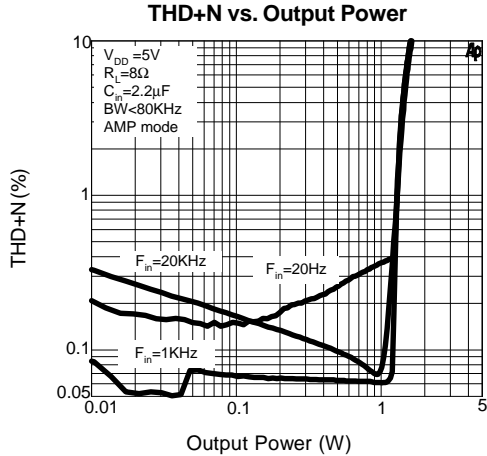



Typical Operating Characteristics (Cont.)

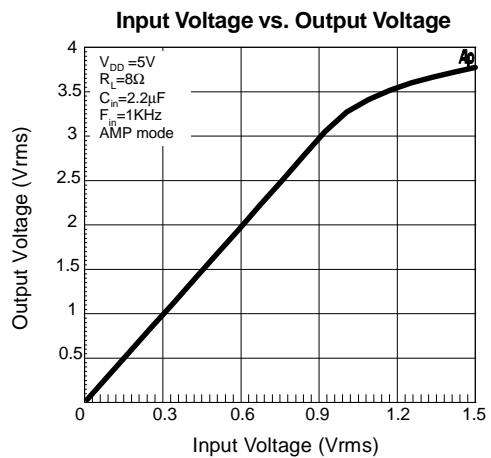
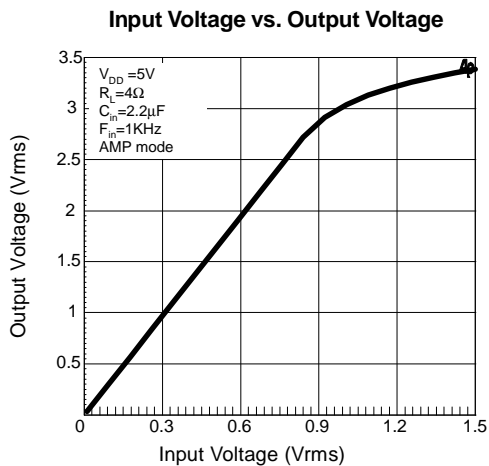
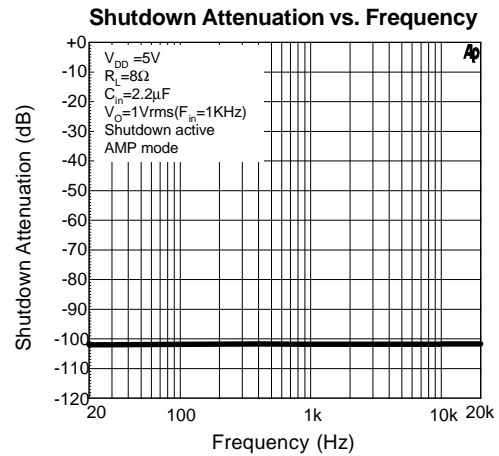
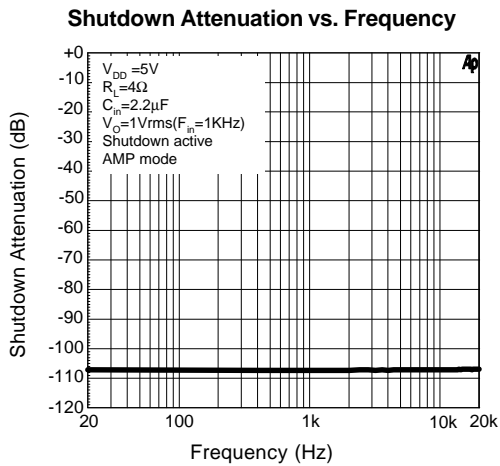
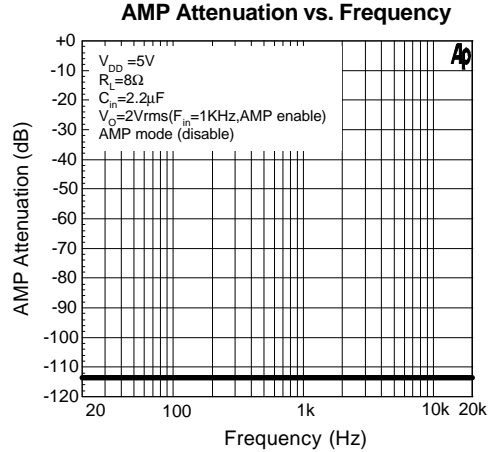
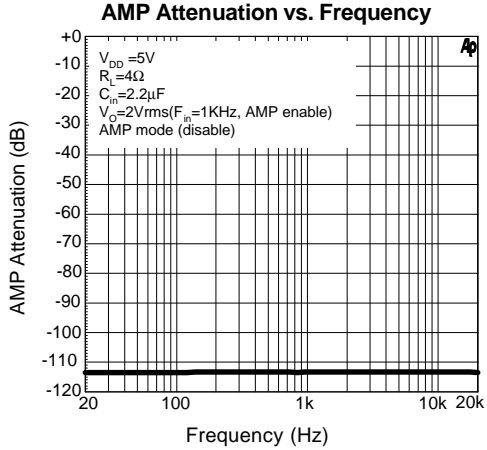

Typical Operating Characteristics (Cont.)

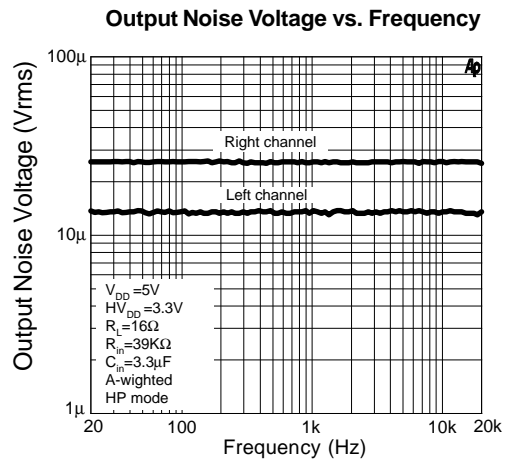
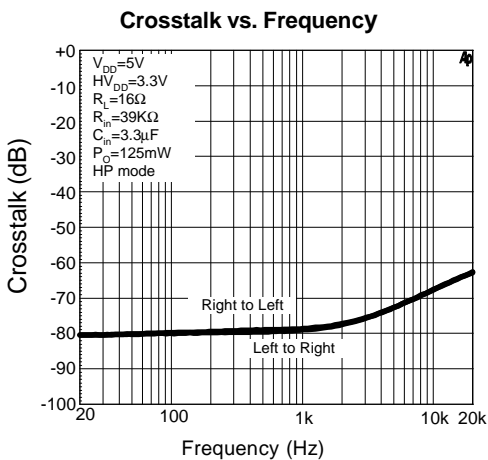
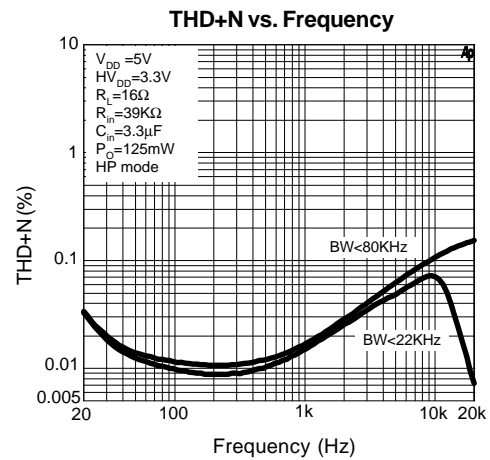
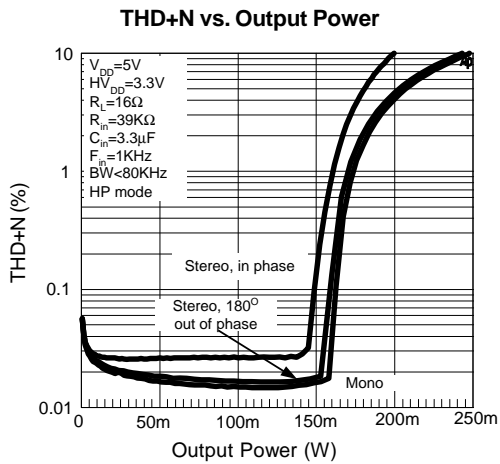
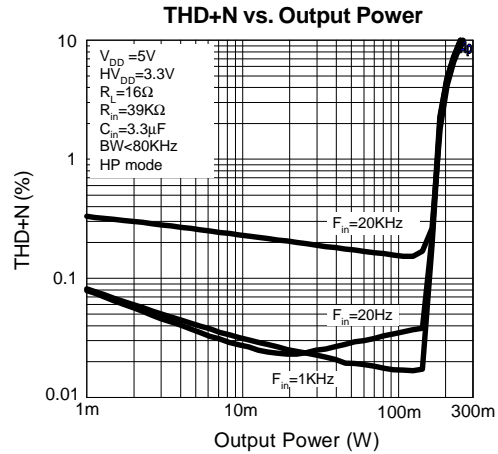
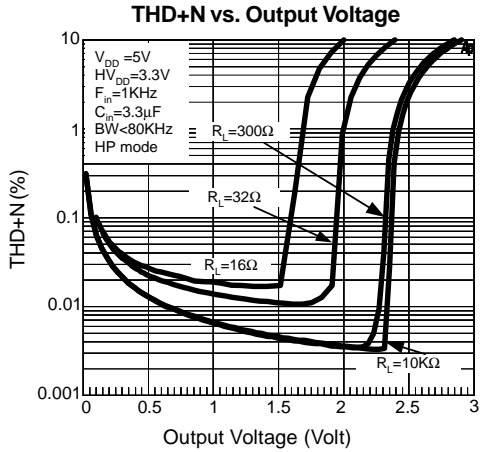

Typical Operating Characteristics (Cont.)

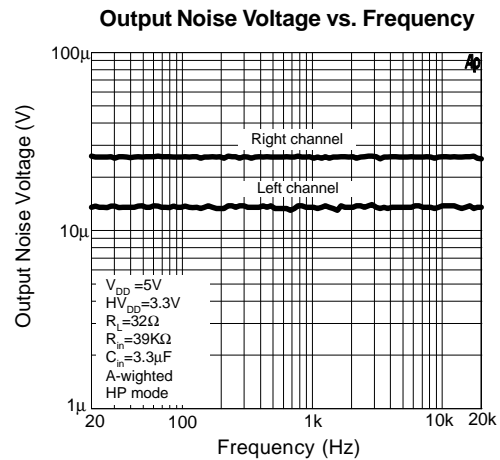
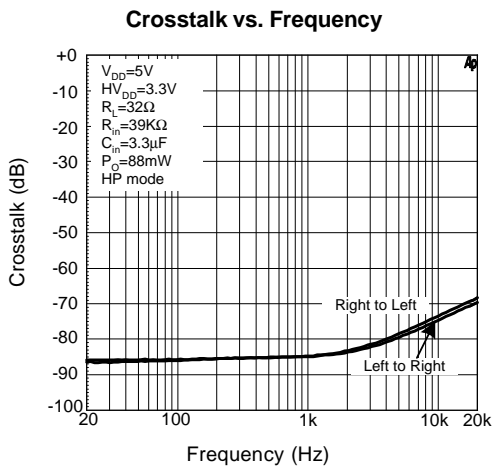
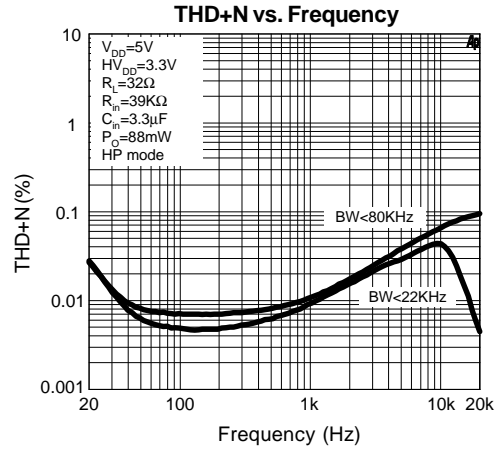
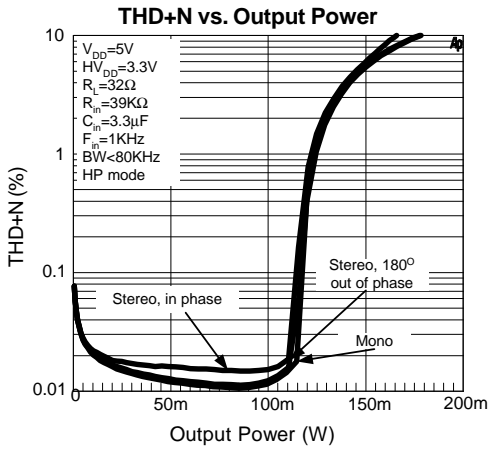
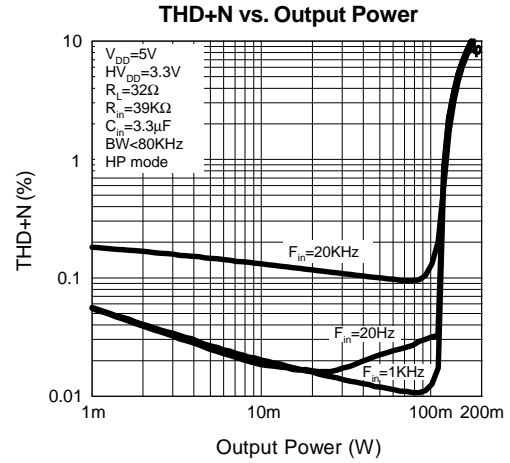
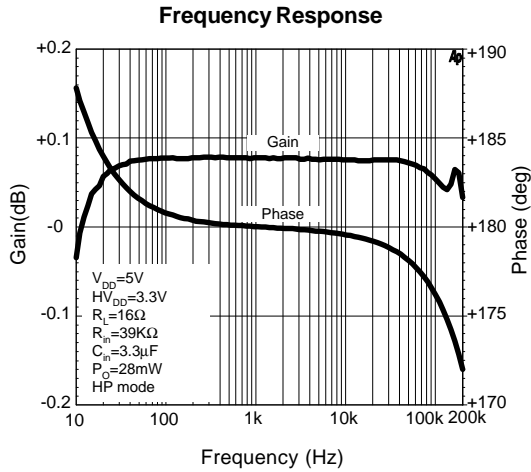

Typical Operating Characteristics (Cont.)

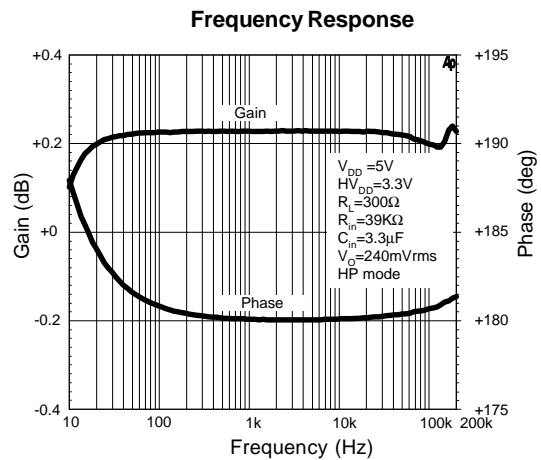
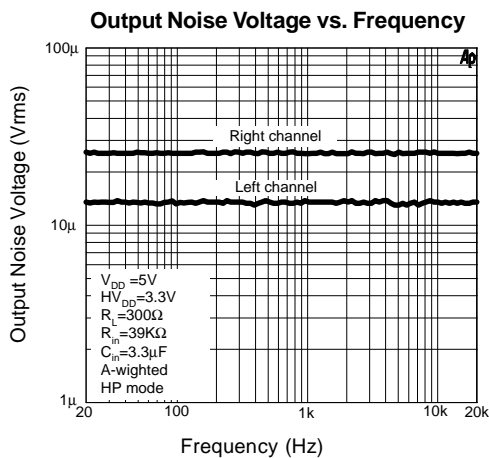
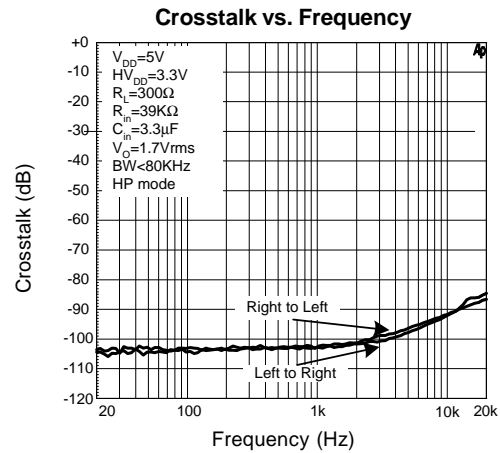
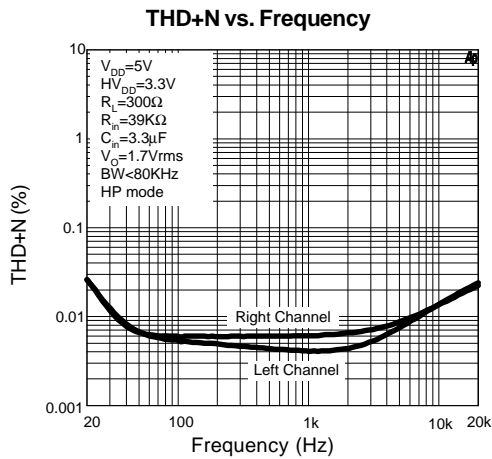
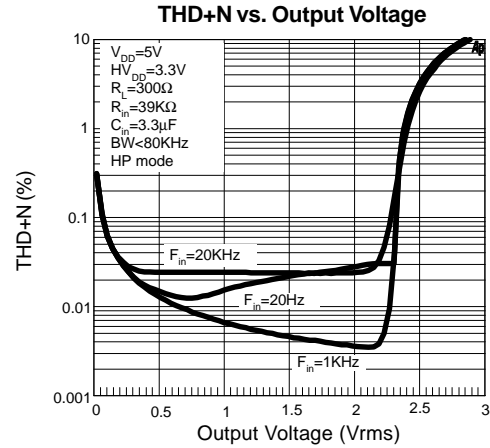
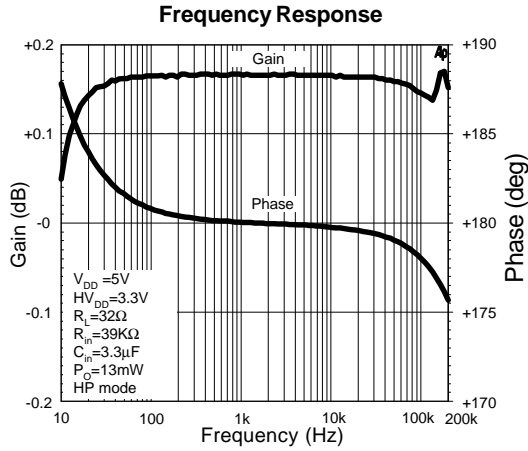

Typical Operating Characteristics (Cont.)

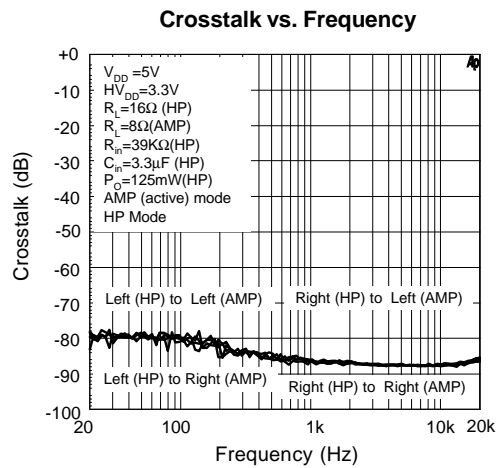
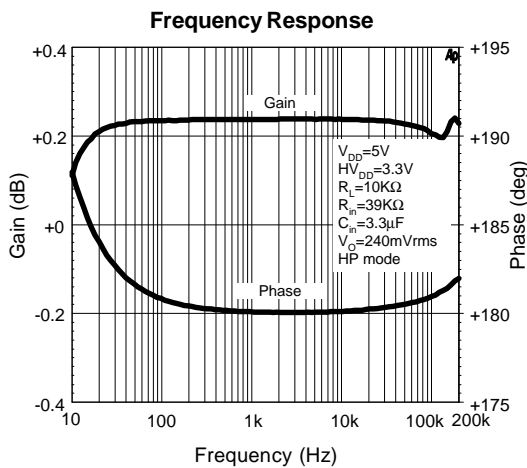
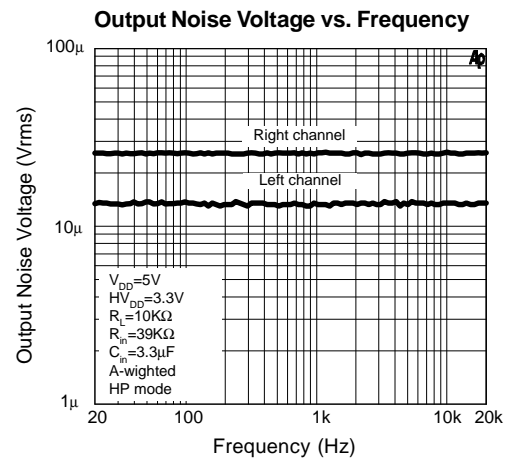
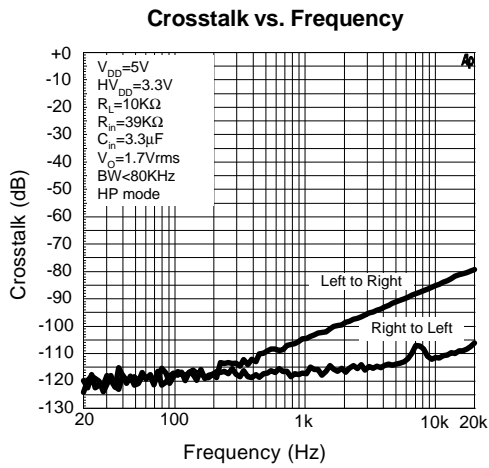
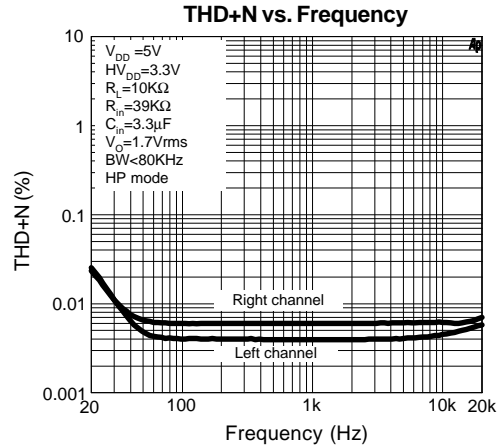
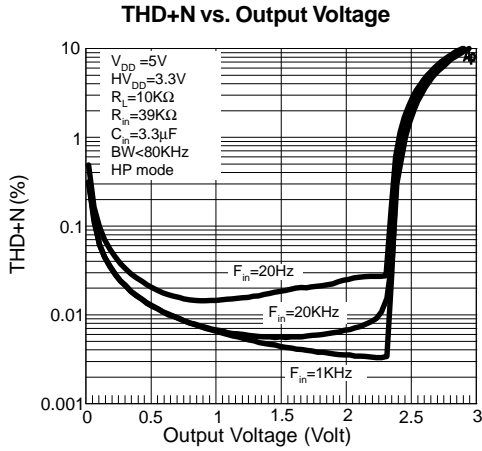

Typical Operating Characteristics (Cont.)

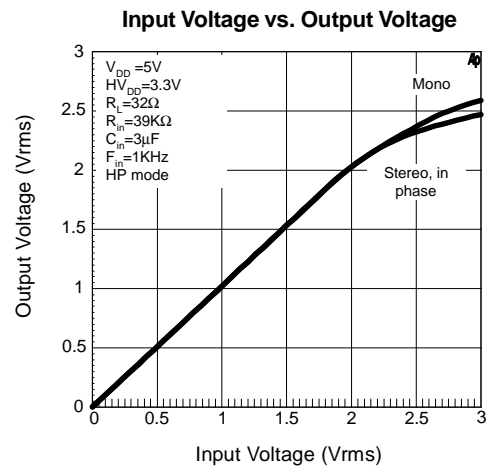
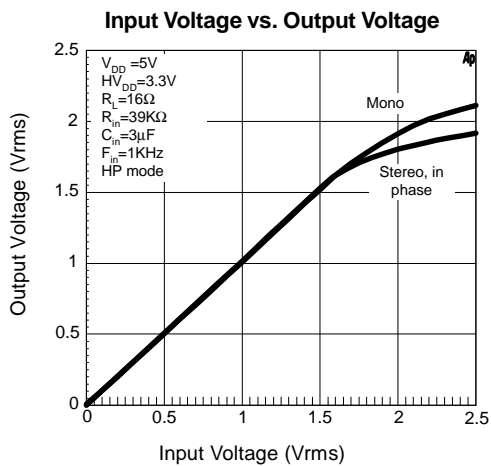
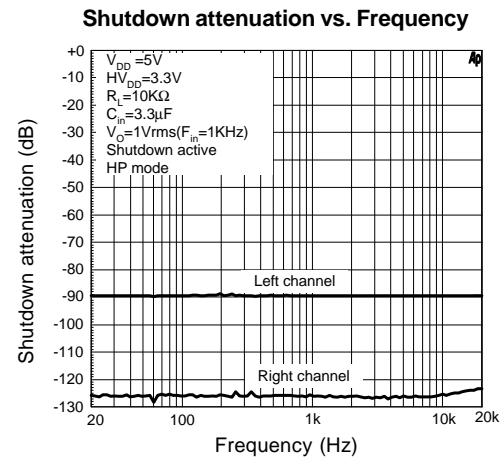
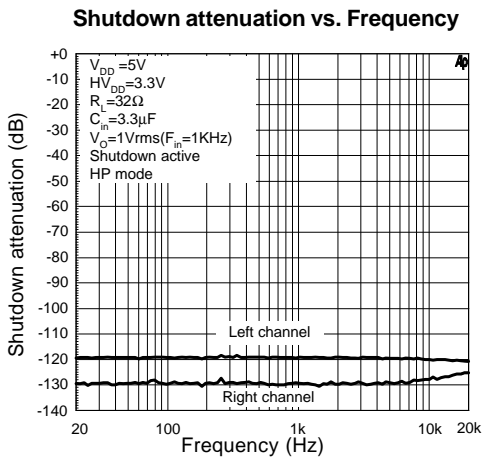
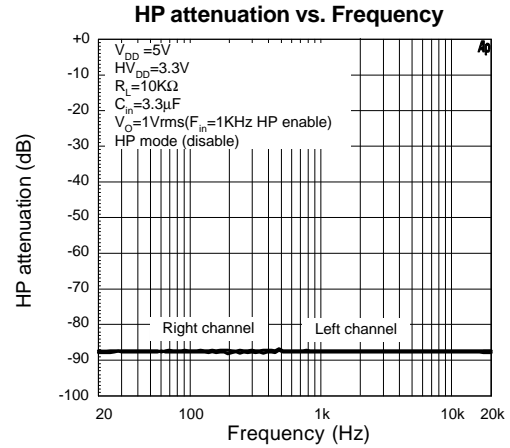
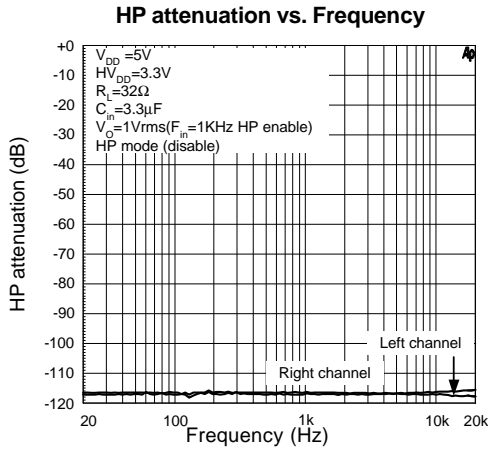

Typical Operating Characteristics (Cont.)

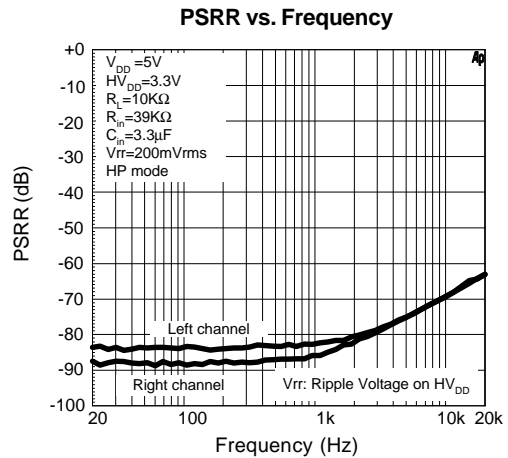
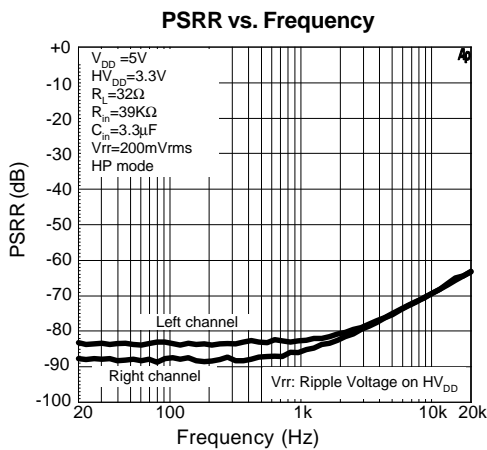
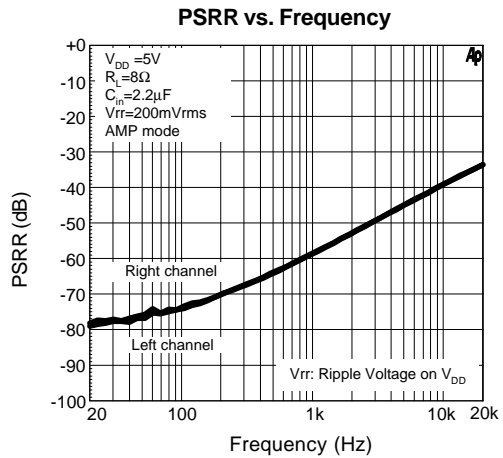
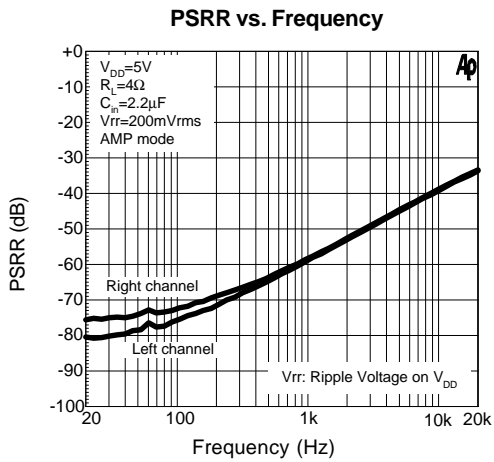
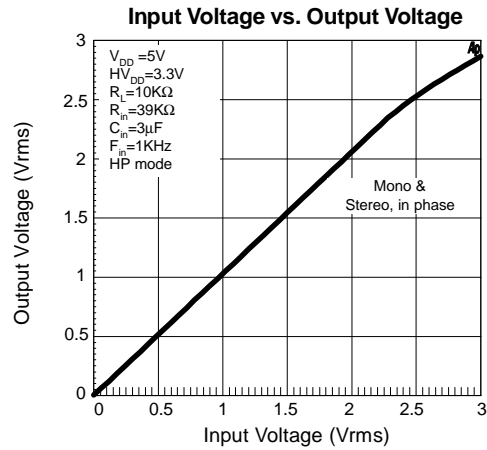
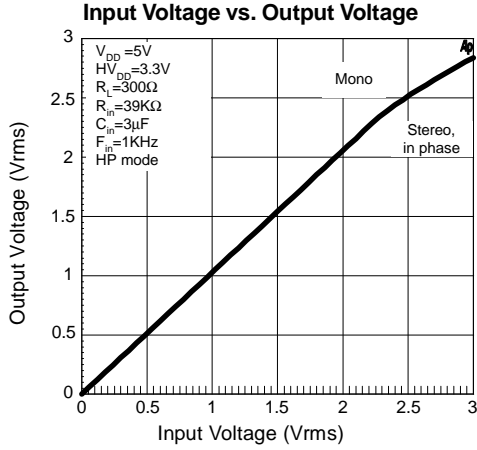

Typical Operating Characteristics (Cont.)

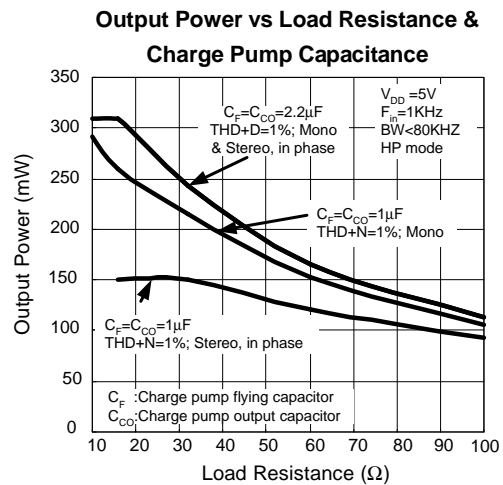
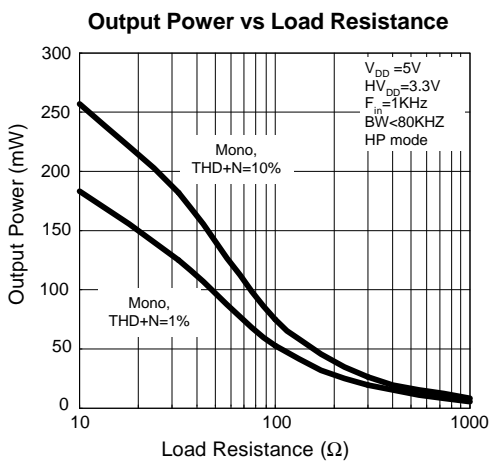
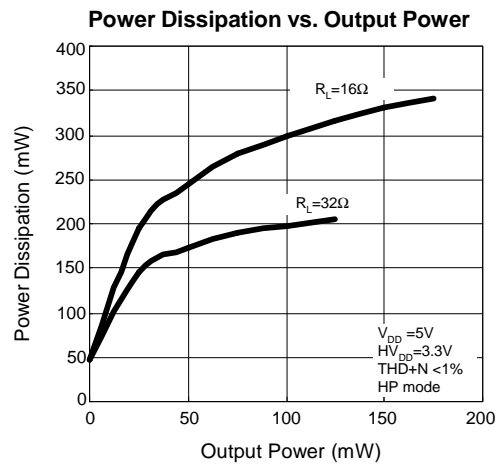
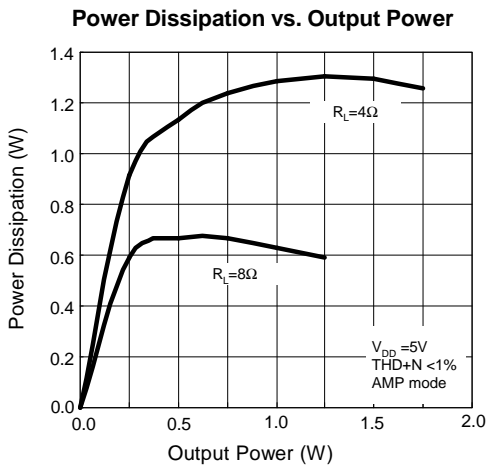
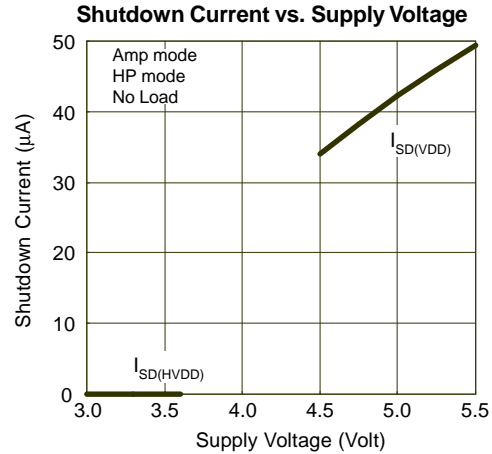
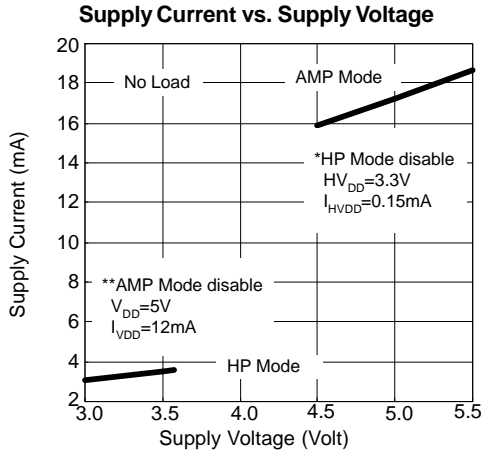



## Operating Waveforms

Output Transient at Turn On

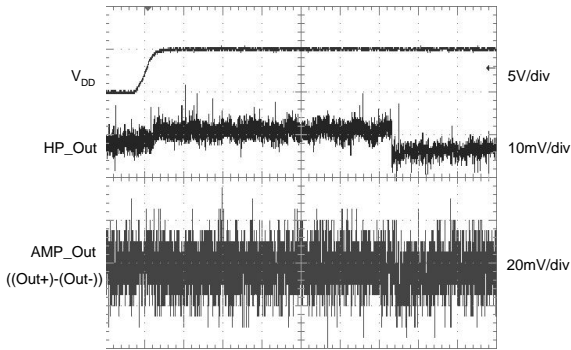

20ms/div

Output transient at Shutdown Release

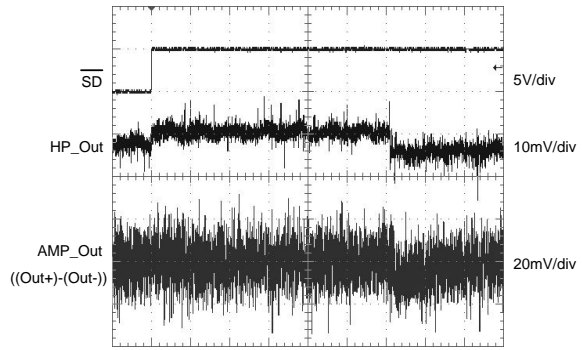

20ms/div

Output Transient at Turn Off

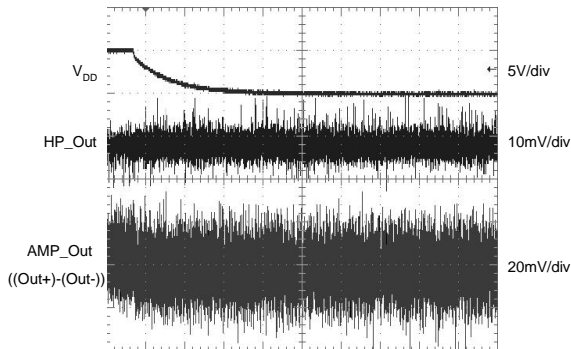

200ms/div

Output transient at Shutdown Active

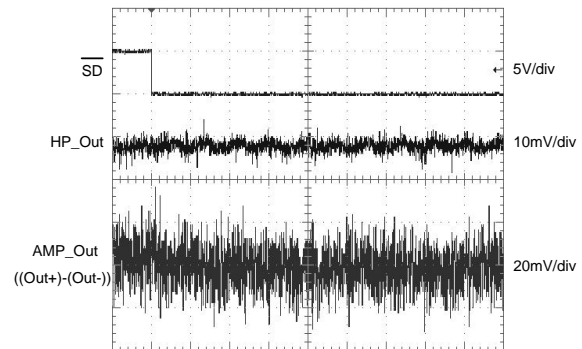

20ms/div

Pin Descriptions

TSSOP-28 NO.	TQFN-28 NO.	Name	Function Description
1	25	VDD	Power supply for control section
2	26	GND	Ground
3	27	INR_A	Right channel input terminal for speaker amplifier
4	28	INR_H	Right channel input terminal for headphone driver
5	1	INL_A	Left channel input terminal for speaker amplifier
6	2	INL_H	Left channel input terminal for headphone driver
7,23	3,19	PGND	Power ground
8	4	LOUT+	Left channel positive output for speaker
9	5	LOUT-	Left channel negative output for speaker
10,20	6,16	PVDD	Power amplifier power supply
11	7	CVDD	Charge pump power supply
12	8	CP+	Charge pump flying capacitor positive connection
13	9	CGND	Charge pump ground
14	10	CP-	Charge pump flying capacitor negative connection
15	11	CVSS	Charge pump output, connect to the "HVSS"
16	12	HVSS	Headphone amplifier negative power supply
17	13	HP_R	Right channel output for headphone
18	14	HP_L	Left channel output for headphone
19	15	HV DD	Headphone amplifier positive power supply
21	17	ROUT-	Right channel negative output for speaker
22	18	ROUT+	Right channel positive output for speaker
24	20	HP_EN	Headphone driver enable pin, pull high to enable headphone mode
25	21	BIAS	Bias voltage generator
26	22	SET	It has 19 steps gain setting control from 2.0~4.2V; pull high to 5V is 10.5dB fix gain and pull low to 0V, the APA2057A enter shutdown mode. I <sub>SD</sub> = 80μA
27	23	AMP_EN	Speaker driver enable pin, pull low to enable speaker mode
28	24	BEEP	PC BEEP Trigger signal input

Block Diagram

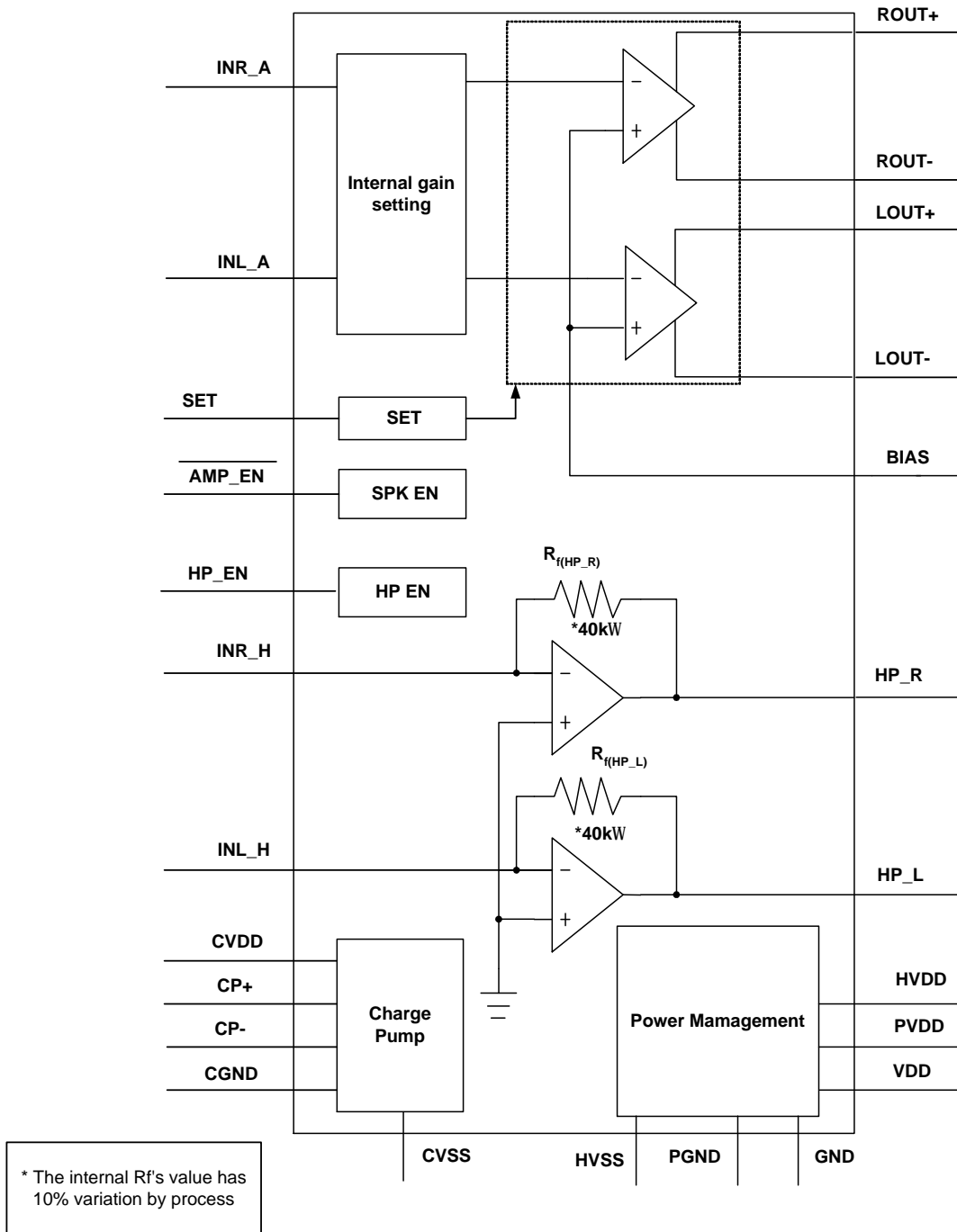

Typical Application Circuit

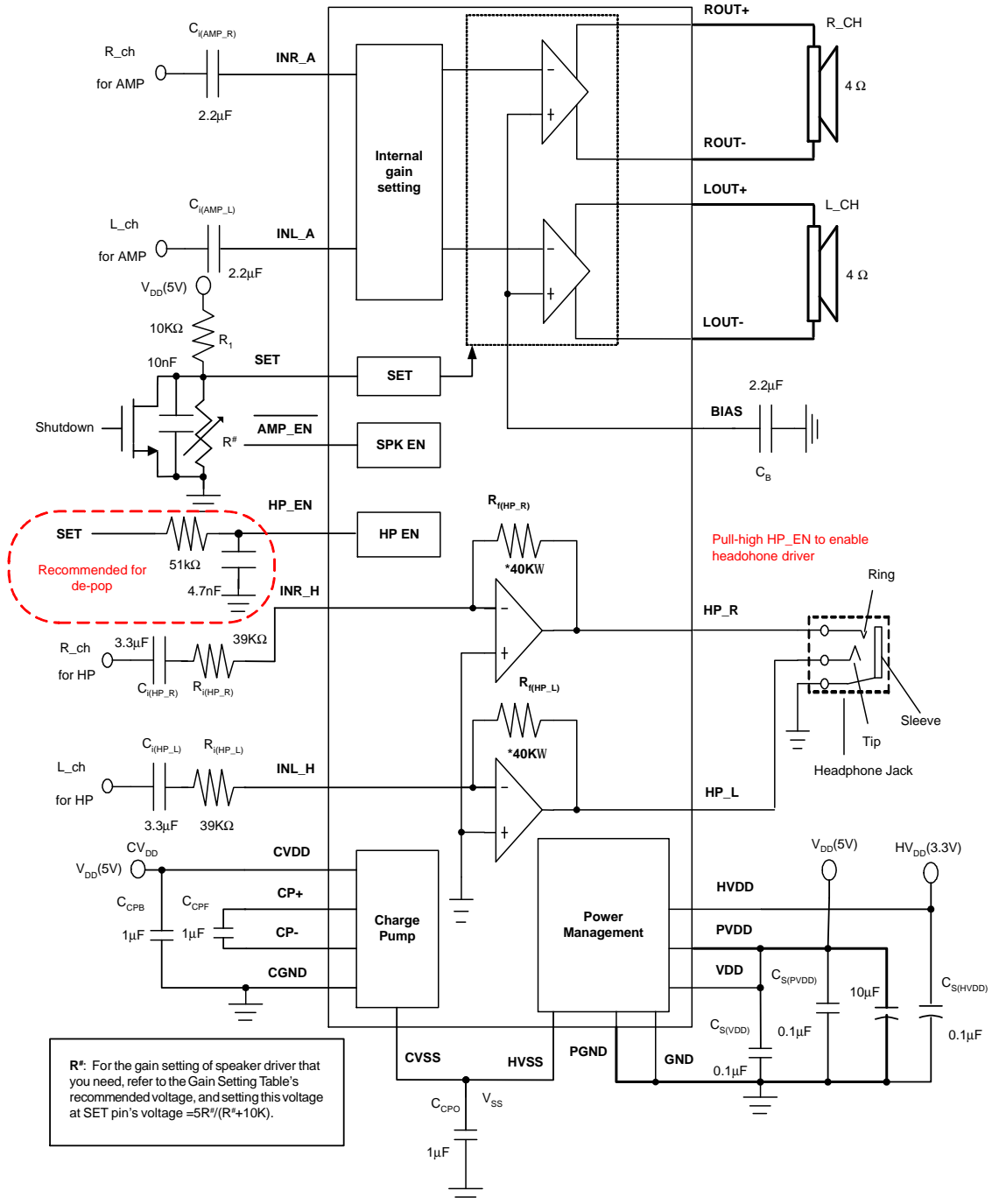

## Application Information

### Amplifier Mode Operation

The APA2057A has two pairs of operational amplifiers internally, which allows different amplifier configurations.

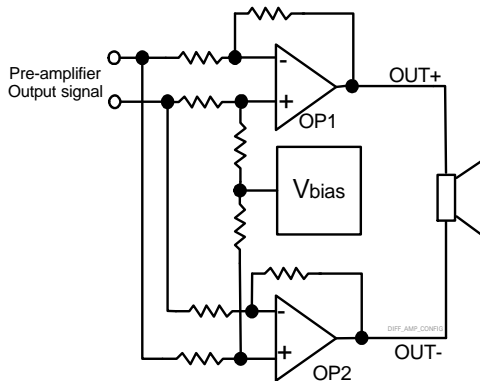

Figure 1: APA2057A internal configuration (each channel)

The OP1 and OP2 are all differential drive configurations. The differential drive configurations doubling the voltage swing on the load. Compare with the single-ended configuration, the differential gain for each channel is 2X (Gain of SE mode).

By driving the load differentially through outputs OUT+ and OUT-, an amplifier configuration commonly referred to all differential mode is established. All differential mode operation is different from the classical single-ended SE amplifier configuration where one side of its load is connected to ground.

A differential amplifier design has a few distinct advantages over the SE configuration, as it provides differential drive to the load, thus it is doubling the output swing for a specified supply voltage. The output power can be 4 times greater than the SE amplifier working under the same condition. A differential configuration, similar as the one used in APA2057A, also creates a second advantage over SE amplifiers. Since the differential outputs, ROUT+, ROUT-, LOU+, and LOU-, are biased at half-supply, there is no need for DC voltage across the load. This eliminates the need for an output coupling capacitor which is required in a single supply, SE configuration.

### Headphone Mode Operation

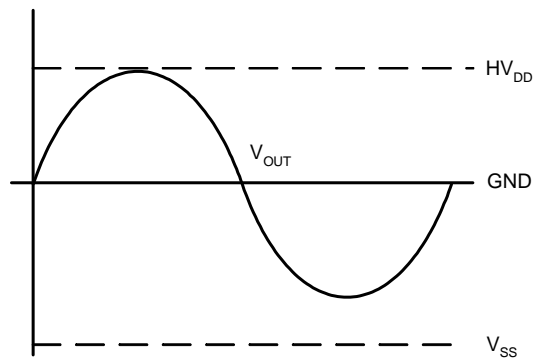
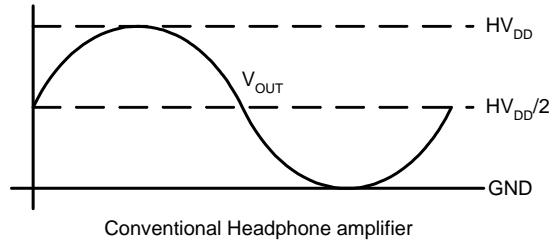

Figure 2: Cap-free Operation

The APA2057A's headphone amplifiers uses a charge pump to invert the positive power supply ( $CV_{DD}$ ) to negative power supply ( $CV_{SS}$ ), see Figure2. The headphone amplifiers operate at this bipolar power supply ( $HV_{DD}$  &  $V_{SS}$ ), and the outputs reference refers to the ground. This feature eliminates the output capacitor that is using in conventional single-ended headphone amplifier. The headphone amplifier internal supply voltage comes from  $HV_{DD}$  and  $V_{SS}$ . For good AC performance, the  $HV_{DD}$  connected to 3.3V is recommended. It can avoid the output over voltage for line out application.

### Charge Pump Flying Capacitor

The flying capacitor ( $C_{CPF}$ ) affects the load transient of the charge pump. If the capacitor's value is too small, then that will degrade the charge pump's current driver capability and the performance of headphone amplifier.

Increasing the flying capacitor's value will improve the load transient of charge pump. It is recommend to use the low ESR ceramic capacitors (X7R type is recommended) above  $1\mu\text{f}$ .



**Application Information (Cont.)**

**Gain Setting (Cont.)**

For headphone driver, the internal feedback resistor is 40kΩ (R<sub>i(HP)</sub> external, 10% variation by process), so the headphone driver's gain is set by the input resistor (R<sub>i(HP)</sub> external), the Table 1 lists the reference gain settings with external resistor for headphone driver (HP Mode).

HP Mode Gain Setting Table for Reference			
R <sub>i(HP)</sub> ,external (kΩ)	*R <sub>i(HP)</sub> ,internal (kΩ)	HP OUT (V/V)	HP Gain(dB)
62	40	0.65	-3.8
50	40	0.80	-1.9
39	40	1.03	0.2
30	40	1.33	2.5
24	40	1.67	4.4
20	40	2.00	6.0

\*The internal R<sub>i</sub>'s value has 10% variation by process.

Table 1: Gain Setting Table for Reference

**Input Capacitor, C<sub>i</sub>**

In the typical application, an input capacitor, C<sub>i</sub> is required to allow the amplifier to bias the input signal to the proper DC level for optimum operation. In this case, C<sub>i</sub> and the minimum input impedance R<sub>i</sub> from a high-pass filter with the corner frequency are determined by the following equation:

$$F_c \text{ (highpass)} = \frac{1}{(2\pi R_{i(\text{MIN})} \times C_i)} \quad (1)$$

The value of C<sub>i</sub> is important to consider as it directly affects the low frequency performance of the circuit. Consider the example where R<sub>i</sub> is 10kΩ and the specification calls for a flat bass response down to 10Hz. Equation is reconfigured as below:

$$C_i = \frac{1}{(2\pi R_i F_c)} \quad (2)$$

Consider to input resistance variation, the C<sub>i</sub> is 1.6μF, so one would likely choose a value in the range of 2.2μF to 3.3μF. A further consideration for this capacitor is the leakage path from the input source through the input network (R<sub>i</sub>+R<sub>i</sub>, C<sub>i</sub>) to the load. This leakage current creates a DC offset voltage at the input to the amplifier that reduces useful headroom, especially in high gain applications. For this reason, a low-leakage tantalum or ceramic capacitor is the best choice. When polarized capacitors are used, the positive side of the capacitor should face the amplifier input. As the DC level is held at V<sub>DD</sub>/2, which is likely higher than the source DC level.

Please note that it is important to confirm the capacitor polarity in the application.

Note: The headphone driver's input is ground reference, so please check the C<sub>i(HP)</sub>'s polarized at design.

**Effective Bias Capacitor, C<sub>b</sub>**

As with any power amplifier, proper supply bypassing is critical for low noise performance and high power supply rejection.

The capacitor location on both the bypass and power supply pins should be as close to the device as possible. The effect of a larger bypass capacitor is improved PSRR due to increased 1.8V bias voltage stability. Typical applications employ a 5V regulator with 2.2μF and a 0.1μF bypass capacitor, which aids in supply filtering. This does not eliminate the need for bypassing the supply nodes of the APA2057A. The selection of bypass capacitors, especially C<sub>b</sub>, is thus dependent upon desired PSRR requirements and click-and-pop performance.

**Power Supply Decoupling, C<sub>s</sub>**

The APA2057A is a high-performance CMOS audio amplifier that requires adequate power supply decoupling to ensure the output total harmonic distortion (THD+N) is as low as possible. Power supply decoupling also prevents the oscillations causing by long lead length between the amplifier and the speaker. The optimum decoupling is achieved by using two different types of capacitor that target on different types of noise on the power supply leads. For higher frequency transients, spikes, or digital hash on the line, a good low equivalent-series-resistance (ESR) ceramic capacitor, typically 0.1μF, is placed as close as possible to the device V<sub>DD</sub> lead works best (the pin1 (V<sub>DD</sub>) and pin2 (GND)'s capacitor must short less than 1cm). For filtering lower-frequency noise signals, a large aluminum electrolytic capacitor of 10μF or greater is placed near the audio power amplifier is recommended.

**Shutdown Function**

In order to reduce power consumption while not in use, the APA2057A contains a shutdown pin to externally turn off the amplifier bias circuitry. This shutdown feature turns the amplifier off when a logic low is placed on the

## Application Information (Cont.)

### Shutdown Function (Cont.)

SET pin. The trigger point between a logic high and logic low level is typically 2.0V. It is the best to switch between ground and the supply  $V_{DD}$  to provide maximum device performance.

By switching the SET pin to low, the amplifier enters a low-current consumption state,  $I_{DD} < 80\mu A$ . Even the APA2057A is in shutdown mode, PC\_BEEP will keep detecting circuit. In normal operating, SET pin is pulled to high level to keep the IC out of the shutdown mode. The SET pin should be tied to a definite voltage to avoid unwanted state changes. The wake-up time of shutdown is about 150ms, and the shutdown release's pop is caused by the operational amplifier's offset.

### PC-BEEP Detection

The APA2057A integrates a PCBEEP circuit detection for notebook PC using. When PC-BEEP signal drives to PCBEEP input pin, PCBEEP mode is active. The APA2057A will turn on speaker drivers and the internal gain is fixed as 0dB. The PCBEEP signal becomes the amplifiers input signal. If the amplifiers in the shutdown mode, it will be out of shutdown mode whenever PCBEEP mode is enabled. The APA2057A will return to previous setting when it is out of PC BEEP mode. The input impedance is 100K $\Omega$  on PCBEEP input pin.

### Speaker Driver Amplifier Efficiency

An easy-to-use equation to calculate efficiency starts out as being equal to the ratio of power from the power supply to the power delivered to the load. The following equations are the basis for calculating amplifier efficiency.

$$\text{Efficiency} = \frac{P_O}{P_{\text{sup}}} \quad (3)$$

Where:

$$P_O = \frac{V_{O\text{rms}} * V_{O\text{rms}}}{R_L} = \frac{(V_P * V_P)}{2R_L} \quad (4)$$

$$V_{O\text{rms}} = \frac{V_P}{\sqrt{2}} \quad (5)$$

$$P_{\text{sup}} = V_{DD} * I_{DD}(\text{AVG}) = V_{DD} * \frac{2V_P}{\pi R_L} \quad (6)$$

Efficiency of a Differential configuration:

$$\frac{P_O}{P_{\text{sup}}} = \left\{ \frac{(V_P * V_P)}{2R_L} \right\} / \left\{ V_{DD} * \frac{2V_P}{\pi R_L} \right\} = \frac{\pi R_L}{4V_{DD}} \quad (7)$$

Table 1 calculates efficiencies for four different output

power levels. Note that the efficiency of the amplifier is quite low for lower power levels and rises sharply as power to the load is increased resulting in nearly flat internal power dissipation over the normal operating range. Note that the internal dissipation at full output power is less than in the half power range. Calculating the efficiency for a specific system is the key to proper power supply design. For a stereo 1W audio system with 8W loads and a 5V supply, the maximum draw on the power supply is almost 3W.

Po (W)	Efficiency (%)	IDD(A)	VPP(V)	PD (W)
0.25	31.25	0.16	2.00	0.55
0.50	47.62	0.21	2.83	0.55
1.00	66.67	0.30	4.00	0.5
1.25	78.13	0.32	4.47	0.35

\*\*High peak voltages cause the THD+N to increase

Table 2. Efficiency vs. Output Power in 5-V/8W Differential Amplifier Systems.

A final point to remember about linear amplifiers is how to manipulate the terms in the efficiency equation to utmost advantage when possible. Note that in equation,  $V_{DD}$  is in the denominator. This indicates that as  $V_{DD}$  goes down, efficiency goes up. In other words, using the efficiency analysis to choose the correct supply voltage and speaker impedance for the application.

### Power Dissipation

Whether the power amplifier is operated in BTL or SE modes, power dissipation is a major concern. Equation 8 states the maximum power dissipation point for a SE mode operating at a given supply voltage and driving a specified load.

$$\text{SE mode: } P_{D,\text{MAX}} = \frac{V_{DD}^2}{2\pi R_L} \quad (8)$$

In BTL mode operation, the output voltage swing is doubled as in SE mode. Thus the maximum power dissipation point for a BTL mode operating at the same given conditions is 4 times as in SE mode.

$$\text{BTL mode: } P_{D,\text{MAX}} = \frac{4V_{DD}^2}{2\pi^2 R_L} \quad (9)$$

Since the APA2057A is a dual channel power amplifier, the maximum internal power dissipation is 2 times that both of equations depending on the mode of operation. Even with this substantial increasing in power dissipation, the APA2057A does not require extra heatsink. The



**Application Information (Cont.)**

**Power Dissipation (Cont.)**

power dissipation from equation 9, assuming a 5V-power supply and an 8Ω load, must not be greater than the power dissipation that results from the equation 9:

$$P_{D,MAX} = \frac{T_{J,MAX} - T_A}{\theta_{JA}} \tag{10}$$

For TSSOP-28 package with thermal pad, the thermal resistance ( $\theta_{JA}$ ) is equal to 45°C/W.

Since the maximum junction temperature ( $T_{J,MAX}$ ) of APA2057A is 150°C and the ambient temperature ( $T_A$ ) is defined by the power system design, the maximum power dissipation that the IC package is able to handle can be obtained from equation 10. Once the power dissipation is greater than the maximum limit ( $P_{D,MAX}$ ), either the supply voltage ( $V_{DD}$ ) must be decreased, the load impedance ( $R_L$ ) must be increased or the ambient temperature should be reduced.

**Thermal Pad Considerations**

The thermal pad must be connected to ground. The package with thermal pad of the APA2057A requires special attention on thermal design. If the thermal design issues are not properly addressed, the APA2057A 4Ω will go into thermal shutdown when driving a 4Ω load. The thermal pad on the bottom of the APA2057A should be soldered down to a copper pad on the circuit board. Heat can be conducted away from the thermal pad through the copper plane to ambient. If the copper plane is not on the top surface of the circuit board, 8 to 10 vias of 15 mil or smaller in diameter should be used to thermally couple the thermal pad to the bottom plane. For good thermal conduction, the vias must be plated through and solder filled. The copper plane used to conduct heat away from the thermal pad should be as large as practical.

If the ambient temperature is higher than 25°C, a larger copper plane or forced-air cooling will be required to keep the APA2057A junction temperature below the thermal shutdown temperature (150°C).

In higher ambient temperature, higher airflow rate and/or larger copper area will be required to keep the IC out of thermal shutdown. See Demo Board Circuit Layout as an example for PCB layout.

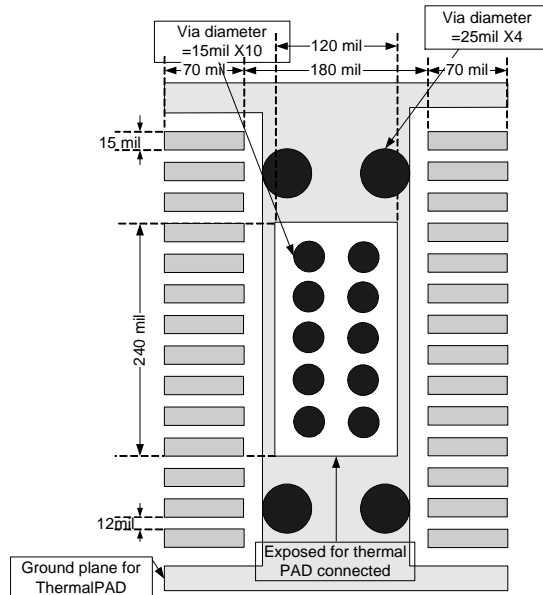

Figure 5: TSSOP-28P layout recommendation

**Thermal Considerations**

Linear power amplifiers dissipate a significant amount of heat in the package under normal operating conditions. In the Power Dissipation vs. Output Power graph, the APA2057A is operating at a 5V supply and a 4Ω speaker that 2W output power peaks are available. The vertical axis gives the information of power dissipation ( $P_D$ ) in the IC with respect to each output driving power ( $P_O$ ) on the horizontal axis.

This is valuable information when attempting to estimate the heat dissipation of the IC requirements for the amplifier system.

Using the power dissipation curves for a 5V/4Ω system, the internal dissipation in the APA2057A and maximum ambient temperatures is shown in Table 3.

Peak output power (W)	Average output power (W)	Power dissipation (W/channel)	Max. $T_A$ (°C)
			With thermal pad
2	1.95	1.25	37
2	1.17	1.25	37
2	0.74	1.19	43
2	0.43	1.05	55
2	0.19	0.8	78

Table 3: APA2057A Power information, 5V/4Ω, Stereo, Differential mode

## Application Information (Cont.)

### Thermal Considerations (Cont.)

Package	$\theta_{JA}$
TSSOP-28	45°C/W
TQFN -28	43°C/W

Table 4: Thermal resistance Table

This parameter is measured with the recommended copper heat sink pattern on a 2-layer PCB, 23cm<sup>2</sup> in 5.7mm \*4mm in PCB, 2oz. Copper, 100mm<sup>2</sup> coverage. Airflow 0 CFM the maximum ambient temperature depends on the heat sink ability of the PCB system.

To calculate maximum ambient temperatures, first consideration is that the numbers from the dissipation graphs are per channel values, so the dissipation of the IC heat needs to be doubled for two-channel operation.

Given  $\theta_{JA}$ , the maximum allowable junction temperature ( $T_{J,Max}$ ), and the total internal dissipation ( $P_D$ ), the maximum ambient temperature can be calculated with the following equation. The maximum recommended junction temperature for the APA2057A is 150°C. The internal dissipation figures are taken from the Power Dissipation vs. Output Power graph.

$$T_{A,Max} = T_{J,Max} - \theta_{JA} P_D \quad (11)$$

$$150 - 45(0.8*2) = 78^\circ\text{C (with thermal pad)}$$

NOTE: Internal dissipation of 0.8W is estimated for a 2W system with 15-dB headroom per channel.

Table 3 shows that for some applications, no airflow is required to keep junction temperatures in the specified range. The APA2057A is designed with a thermal shut-down protection that turns the device off when the junction temperature surpasses 150°C to prevent IC from damage. The information in table 3 was calculated for maximum listen volume with limited distortion. When the output level is reduced, the numbers in the table change significantly. Also, using 8Ω speakers will dramatically increase the thermal performance by increasing amplifier efficiency.

## Package Information

### TSSOP-28P

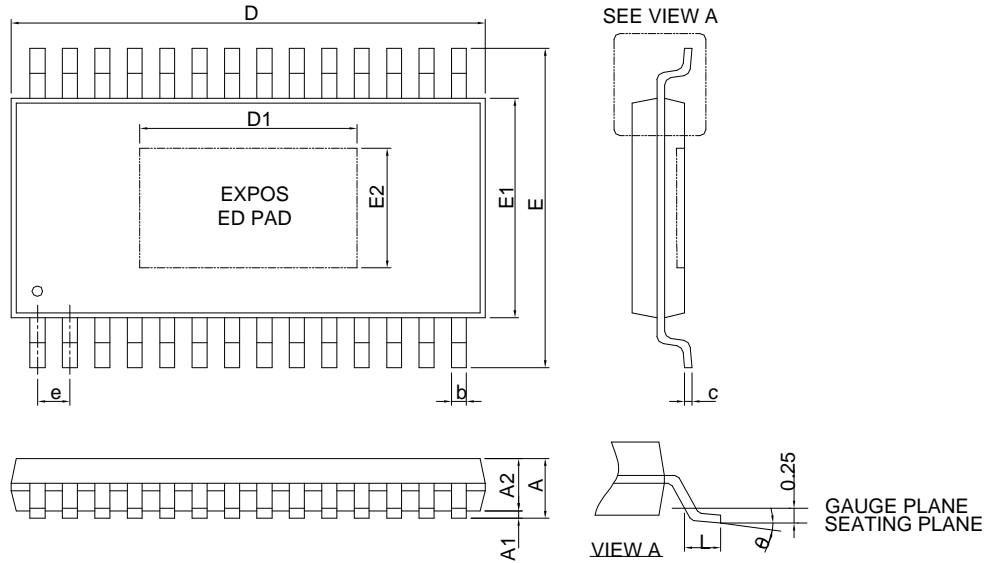

SYMBOL	TSSOP-28P			
	MILLIMETERS		INCHES	
	MIN.	MAX.	MIN.	MAX.
A		1.20		0.047
A1	0.05	0.15	0.002	0.006
A2	0.80	1.05	0.031	0.041
b	0.19	0.30	0.007	0.012
c	0.09	0.20	0.004	0.008
D	9.60	9.80	0.378	0.386
D1	3.30	7.00	0.130	0.276
E	6.40 BSC		0.252 BSC	
E1	4.30	4.50	0.169	0.177
E2	1.50	4.00	0.059	0.157
e	0.65 BSC		0.026 BSC	
L	0.45	0.75	0.018	0.030
θ	0°	8°	0°	8°

- Note : 1. Followed from JEDEC MO-153 AET.  
 2. Dimension "D" does not include mold flash, protrusions or gate burrs. Mold flash, protrusion or gate burrs shall not exceed 6 mil per side.  
 3. Dimension "E1" does not include inter-lead flash or protrusions. Inter-lead flash and protrusions shall not exceed 10 mil per side.

## Package Information

TQFN5x5-28

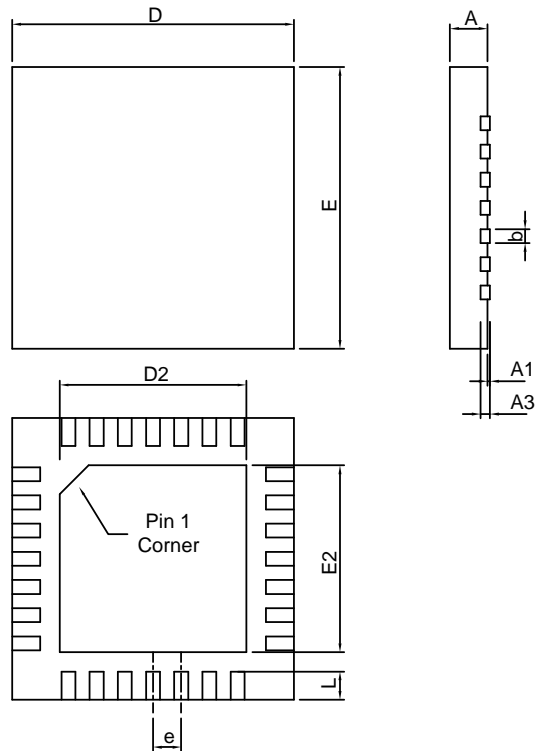

SYMBOL	TQFN5x5-28			
	MILLIMETERS		INCHES	
	MIN.	MAX.	MIN.	MAX.
A	0.70	0.80	0.028	0.031
A1	0.00	0.05	0.000	0.002
A3	0.20 REF		0.008 REF	
b	0.18	0.30	0.007	0.012
D	5.00 BSC		0.197 BSC	
D2	3.50	3.80	0.138	0.150
E	5.00 BSC		0.197 BSC	
E2	3.50	3.80	0.138	0.150
e	0.50 BSC		0.020 BSC	
L	0.35	0.45	0.014	0.018

Carrier Tape & Reel Dimensions

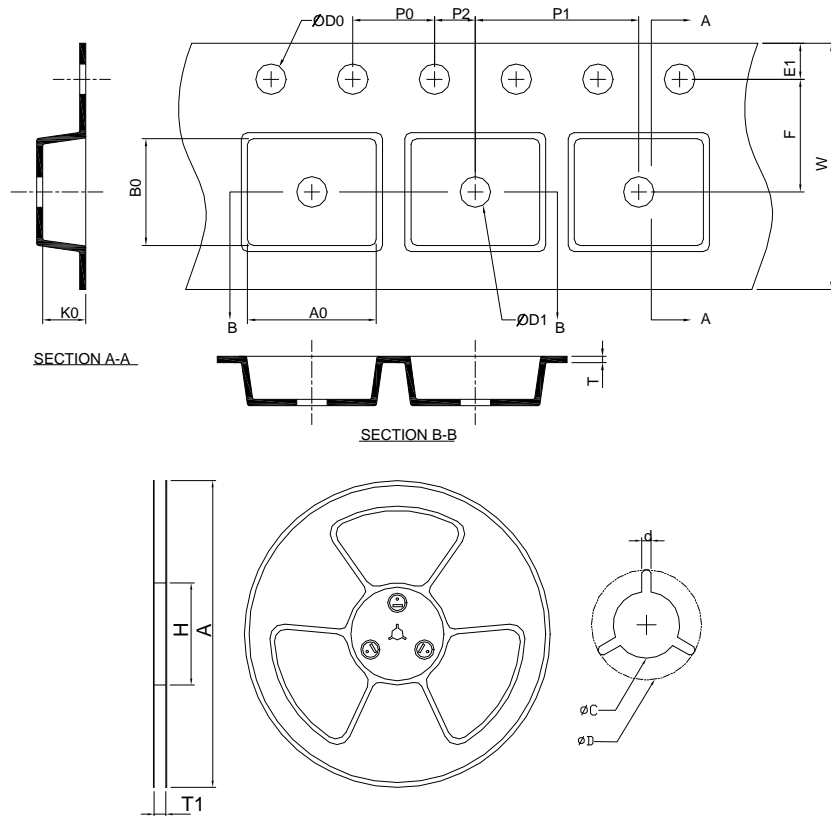

<b>Application</b>	<b>A</b>	<b>H</b>	<b>T1</b>	<b>C</b>	<b>d</b>	<b>D</b>	<b>W</b>	<b>E1</b>	<b>F</b>
<b>TSSOP-28P</b>	330.0 ±2.00	50 MIN.	16.4+2.00 -0.00	13.0+0.50 -0.20	1.5 MIN.	20.2 MIN.	16.0 ±0.30	1.75 ±0.10	7.5 ±0.10
	<b>P0</b>	<b>P1</b>	<b>P2</b>	<b>D0</b>	<b>D1</b>	<b>T</b>	<b>A0</b>	<b>B0</b>	<b>K0</b>
	4.0 ±0.10	8.0 ±0.10	2.0 ±0.10	1.5+0.10 -0.00	1.5 MIN.	0.6+0.00 -0.40	6.90 ±0.20	10.2 ±0.20	1.50 ±0.20
<b>Application</b>	<b>A</b>	<b>H</b>	<b>T1</b>	<b>C</b>	<b>d</b>	<b>D</b>	<b>W</b>	<b>E1</b>	<b>F</b>
<b>TQFN5x5-28</b>	330.0 ±2.00	50 MIN.	16.4+2.00 -0.00	13.0+0.50 -0.20	1.5 MIN.	20.2 MIN.	12.0 ±0.30	1.75 ±0.10	5.5 ±0.10
	<b>P0</b>	<b>P1</b>	<b>P2</b>	<b>D0</b>	<b>D1</b>	<b>T</b>	<b>A0</b>	<b>B0</b>	<b>K0</b>
	4.0 ±0.10	12.0 ±0.10	2.0 ±0.10	1.5+0.10 -0.00	1.5 MIN.	0.6+0.00 -0.40	5.30 ±0.20	5.30 ±0.20	1.30 ±0.20

(mm)

Devices Per Unit

Package Type	Unit	Quantity
TSSOP- 28P	Tape & Reel	2000
TQFN5x5-28	Tape & Reel	2500

**Reflow Condition (IR/Convection or VPR Reflow)**

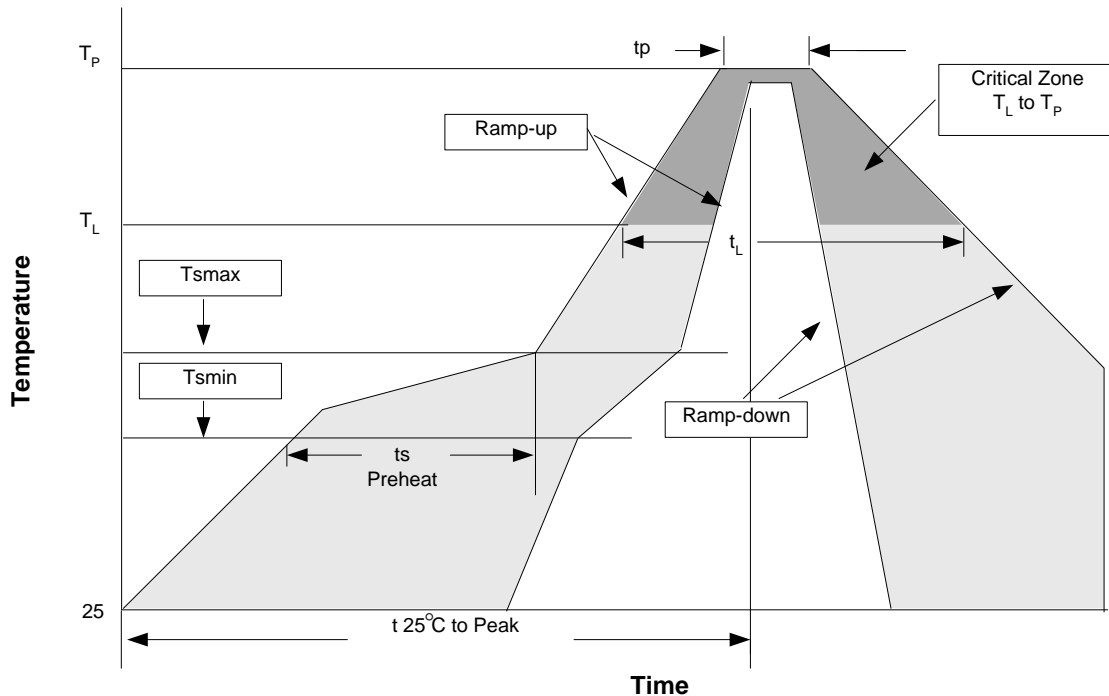

**Reliability Test Program**

Test item	Method	Description
SOLDERABILITY	MIL-STD-883D-2003	245°C, 5 sec
HOLT	MIL-STD-883D-1005.7	1000 Hrs Bias @125°C
PCT	JESD-22-B,A102	168 Hrs, 100%RH, 121°C
TST	MIL-STD-883D-1011.9	-65°C~150°C, 200 Cycles
ESD	MIL-STD-883D-3015.7	VHBM > 2KV, VMM > 200V
Latch-Up	JESD 78	10ms, $I_{tr} > 100mA$

**Classification Reflow Profiles**

Profile Feature	Sn-Pb Eutectic Assembly	Pb-Free Assembly
Average ramp-up rate ( $T_L$ to $T_P$ )	3°C/second max.	3°C/second max.
Preheat		
- Temperature Min ( $T_{smin}$ )	100°C	150°C
- Temperature Max ( $T_{smax}$ )	150°C	200°C
- Time (min to max) ( $t_s$ )	60-120 seconds	60-180 seconds
Time maintained above:		
- Temperature ( $T_L$ )	183°C	217°C
- Time ( $t_L$ )	60-150 seconds	60-150 seconds
Peak/Classification Temperature ( $T_p$ )	See table 1	See table 2
Time within 5°C of actual Peak Temperature ( $t_p$ )	10-30 seconds	20-40 seconds
Ramp-down Rate	6°C/second max.	6°C/second max.
Time 25°C to Peak Temperature	6 minutes max.	8 minutes max.

Notes: All temperatures refer to topside of the package. Measured on the body surface.

**Classification Reflow Profiles (Cont.)**

Table 1. SnPb Eutectic Process – Package Peak Reflow Temperatures

Package Thickness	Volume mm <sup>3</sup> <350	Volume mm <sup>3</sup> ≥350
<2.5 mm	240 +0/-5°C	225 +0/-5°C
≥2.5 mm	225 +0/-5°C	225 +0/-5°C

Table 2. Pb-free Process – Package Classification Reflow Temperatures

Package Thickness	Volume mm <sup>3</sup> <350	Volume mm <sup>3</sup> 350-2000	Volume mm <sup>3</sup> >2000
<1.6 mm	260 +0°C*	260 +0°C*	260 +0°C*
1.6 mm – 2.5 mm	260 +0°C*	250 +0°C*	245 +0°C*
≥2.5 mm	250 +0°C*	245 +0°C*	245 +0°C*

\* Tolerance: The device manufacturer/supplier **shall** assure process compatibility up to and including the stated classification temperature (this means Peak reflow temperature +0°C. For example 260°C+0°C) at the rated MSL level.

**Customer Service**

**Anpec Electronics Corp.**

Head Office :

No.6, Dusing 1st Road, SBIP,  
Hsin-Chu, Taiwan, R.O.C.  
Tel : 886-3-5642000  
Fax : 886-3-5642050

Taipei Branch :

2F, No. 11, Lane 218, Sec 2 Jhongsing Rd.,  
Sindian City, Taipei County 23146, Taiwan  
Tel : 886-2-2910-3838  
Fax : 886-2-2917-3838