

Windows Vista-Compliant, Stereo Class AB Speaker Amplifiers and DirectDrive Headphone Amplifiers

General Description

The MAX9789/MAX9790 combine a stereo, 2W Class AB speaker power amplifier with a stereo 100mW DirectDrive® headphone amplifier in a single device. The MAX9789/MAX9790 are designed for use with the Microsoft Windows Vista® operating system and are fully compliant with Microsoft's Windows Vista specifications. The headphone amplifier features Maxim's patented† DirectDrive architecture that produces a ground-referenced output from a single supply to eliminate the need for large DC-blocking capacitors, as well as save cost, board space, and component height. A high +90dB PSRR and low 0.002% THD+N ensures clean, low-distortion amplification of the audio signal.

Separate speaker and headphone amplifier control inputs provide independent shutdown of the speaker and headphone amplifiers, allowing speaker and headphone amplifiers to be active simultaneously, if required. The industry-leading click-and-pop suppression circuitry reduces audible transients during startup and shutdown cycles.

The MAX9789 features an internal LDO that can be used as a clean power supply for a CODEC or other circuits. The LDO output voltage is set internally at 4.75V or can be adjusted between 1.21V and 4.75V using a simple resistive divider. The LDO is protected against thermal overloads and short circuits while providing 120mA of continuous output current and can be enabled independently of the audio amplifiers.

By disabling the speaker and headphone amplifiers, and the LDO (for MAX9789), the MAX9789/MAX9790 enter low-power shutdown mode and draw only 0.3µA.

The MAX9789/MAX9790 operate from a single 4.5V to 5.5V supply and feature thermal-overload and output short-circuit protection. Devices are specified over the -40°C to +85°C extended temperature range.

Applications

Notebook Computers

Tablet PCs

Portable Multimedia Players

Pin Configurations appear at end of data sheet.

†U.S. Patent # 7,061,327.

Windows Vista is a registered trademark of Microsoft Corp.

DirectDrive is a registered trademark of Maxim Integrated Products, Inc.

Maxim Integrated Products 1

For pricing, delivery, and ordering information, please contact Maxim Direct at 1-888-629-4642, or visit Maxim's website at www.maxim-ic.com.

Features

- ◆ Microsoft Windows Vista Compliant
- ◆ Class AB 2W Stereo BTL Speaker Amplifier
- ◆ 100mW DirectDrive Headphone Amplifier Eliminates Costly, Bulky DC-Blocking Capacitors
- ◆ Excellent RF Immunity
- ◆ Integrated 120mA LDO (MAX9789)
- ◆ High +90dB PSRR, Low 0.002% THD+N
- ◆ Low-Power Shutdown Mode
- ◆ Click-and-Pop Suppression
- ◆ Short-Circuit and Thermal-Overload Protection
- ◆ Available in 32-Pin Thin QFN (5mm x 5mm x 0.8mm) Package

Ordering Information

PART	PIN-PACKAGE	INTERNAL LDO	t _{ON} (ms)
MAX9789AETJ+	32 TQFN-EP*	Yes	100
MAX9789BETJ+**	32 TQFN-EP*	Yes	25
MAX9789CETJ+	32 TQFN-EP*	Yes	100
MAX9790AETJ+	32 TQFN-EP*	No	100
MAX9790BETJ+**	32 TQFN-EP*	No	25

Note: All devices are specified over the -40°C to +85°C extended temperature range.

+Denotes a lead-free/RoHS-compliant package.

*EP = Exposed pad.

**Future product—contact factory for availability.

Simplified Block Diagrams

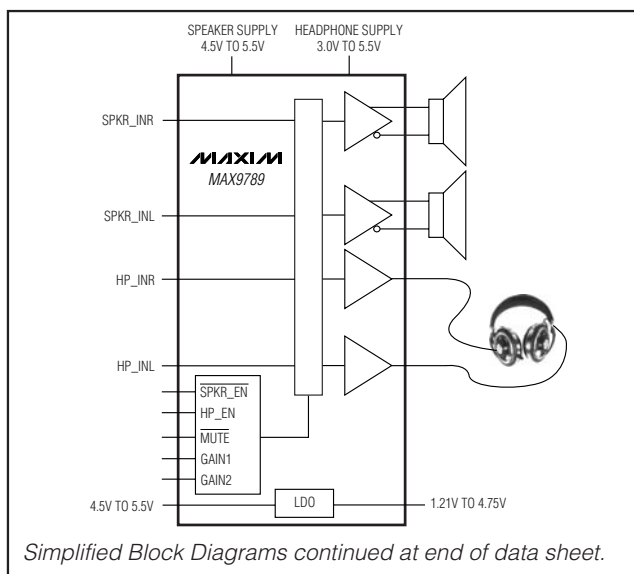

Windows Vista-Compliant, Stereo Class AB Speaker Amplifiers and DirectDrive Headphone Amplifiers

ABSOLUTE MAXIMUM RATINGS

Supply Voltage (V _{DD} , PV _{DD} , HPV _{DD} , CPV _{DD} to GND)	-0.3V to +6.0V
GND to PGND, CPGND	±0.3V
CPV _{SS} , C1N, V _{SS} to GND	-6.0V to +0.3V
HPR, HPL to GND	±3.0V
Any Other Pin	-0.3V to (V _{DD} + 0.3V)
Duration of OUT ₊ , OUT ₋ Short Circuit to GND or PV _{DD}	Continuous
Duration of Short Circuit between OUT ₊ , OUT ₋ and LDO_OUT	Continuous
Duration of Short Circuit between HPR, HPL and GND, V _{SS} or HPV _{DD}	Continuous
Continuous Current (PV _{DD} , OUT ₊ , OUT ₋ , PGND)	1.7A
Continuous Current (CPV _{DD} , C1N, C1P, CPV _{SS} , PV _{SS} , V _{DD} , HPV _{DD} , LDO_OUT, HPR, HPL)	850mA

Continuous Input Current (all other pins)	±20mA
Continuous Power Dissipation (T _A = +70°C)	
32-Pin Thin QFN Single-Layer Board (derate 18.6mW/°C above +70°C)	1489mW
θ _{JA}	53.7°C/W
θ _{JC}	19.9°C/W
32-Pin Thin QFN Multilayer Board (derate 24.9 mW/°C above +70°C)	1990mW
θ _{JA}	40.2°C/W
θ _{JC}	19.9°C/W
Operating Temperature Range	-40°C to +85°C
Junction Temperature	+150°C
Storage Temperature Range	-65°C to +150°C
Lead Temperature (soldering, 10s)	+300°C

Note 1: Package thermal resistances were obtained using the method described in JEDEC specification JESD51-7 using a four-layer board. For detailed information on package thermal considerations, refer to www.maxim-ic.com/thermal-tutorial.

Stresses beyond those listed under "Absolute Maximum Ratings" may cause permanent damage to the device. These are stress ratings only, and functional operation of the device at these or any other conditions beyond those indicated in the operational sections of the specifications is not implied. Exposure to absolute maximum rating conditions for extended periods may affect device reliability.

ELECTRICAL CHARACTERISTICS

(V_{DD} = PV_{DD} = CPV_{DD} = HPV_{DD} = HP_EN = V_{LDO_EN} (MAX9789 only) = +5V, V_{GND} = V_{PGND} = V_{CPGND} = SPKR_EN = V_{LDO_SET} (MAX9789 only) = 0V, I_{LDO_OUT} (MAX9789 only) = 0, C1 = C2 = C_{BIAS} = 1μF, R_L = ∞, unless otherwise specified, V_{GAIN1} = 0, V_{GAIN2} = 5V (A_{VSP} = 10dB, A_{VHP} = 3.5dB), T_A = T_{MIN} to T_{MAX}, unless otherwise noted. Typical values are at T_A = +25°C.) (Note 2)

PARAMETER	SYMBOL	CONDITIONS	MIN	TYP	MAX	UNITS
GENERAL						
Supply Voltage	V _{DD} , PV _{DD}	Guaranteed by PSRR and LDO Line Regulation Tests	4.5		5.5	V
Headphone Supply Voltage	CPV _{DD} , HPV _{DD}	Guaranteed by PSRR Test	3.0		5.5	V
Quiescent Current	I _{DD}	SPKR_EN				
		HP_EN				
		1 (MAX9789)	0 (MAX9789)	0.1	0.4	mA
		1 (MAX9790)	0 (MAX9790)	0.3	6	μA
		1	1	7	13	mA
0	0	14	29			
Shutdown Current	I _{SHDN}	SPKR_EN = V _{DD} , HP_EN = LDO_EN = GND		0.3	6	μA
Bias Voltage	V _{BIAS}		1.7	1.8	1.9	V
Shutdown to Full Operation	t _{SON}	MAX9789A/MAX9789C/MAX9790A		100		ms
		MAX9789B/MAX9790B		25		
Gain Switching Time	t _{SW}			10		μs
Channel-to-Channel Gain Tracking				±0.1		dB
SPEAKER AMPLIFIER						
Output Power	P _{OUT}	THD+N = 1%, f = 1kHz, T _A = +25°C	R _L = 4Ω	2		W
			R _L = 8Ω	1		
Total Harmonic Distortion Plus Noise	THD+N	R _L = 8Ω, P _{OUT} = 1W, f = 1kHz		0.002		%
		R _L = 4Ω, P _{OUT} = 1W, f = 1kHz		0.004		

Windows Vista-Compliant, Stereo Class AB Speaker Amplifiers and DirectDrive Headphone Amplifiers

MAX9789/MAX9790

ELECTRICAL CHARACTERISTICS (continued)

(V_{DD} = PV_{DD} = CPV_{DD} = HPV_{DD} = HP_EN = V_{LDO_EN} (MAX9789 only) = +5V, V_{GND} = VP_{GND} = V_{CPGND} = $\overline{\text{SPKR_EN}}$ = V_{LDO_SET} (MAX9789 only) = 0V, I_{LDO_OUT} (MAX9789 only) = 0, C1 = C2 = C_{BIAS} = 1μF, R_L = ∞, unless otherwise specified, V_{GAIN1} = 0, V_{GAIN2} = 5V (A_{VSP} = 10dB, A_{VHP} = 3.5dB), T_A = T_{MIN} to T_{MAX}, unless otherwise noted. Typical values are at T_A = +25°C.) (Note 2)

PARAMETER	SYMBOL	CONDITIONS		MIN	TYP	MAX	UNITS
Power-Supply Rejection Ratio	PSRR	V _{DD} = 4.5V to 5.5V, T _A = +25°C		72	90		dB
		f = 1kHz, 200mV _{P-P} (Note 4)			70		
		f = 10kHz, 200mV _{P-P} (Note 4)			50		
Voltage Gain	A _V	GAIN1	GAIN2				dB
		0	0		6		
		0	1		10		
		1	0		15.6		
		1	1		21.6		
Input Impedance	R _{IN}	Measured at speaker amplifier inputs					kΩ
		GAIN1	GAIN2				
		0	0		80		
		0	1		65		
		1	0		45		
Output Offset Voltage	V _{OS}	Measured between OUT ₊ and OUT ₋ , T _A = +25°C			±1	±15	mV
			MAX9789C		±1	±25	
Click-and-Pop Level	K _{CP}	R _L = 8Ω, peak voltage, A-weighted, 32 samples per second (Notes 3, 4)	Into shutdown		-50		dBV
			Out of shutdown		-50		
Signal-to-Noise Ratio	SNR	R _L = 8Ω, P _{OUT} = 1W	A-weighted		102		dB
			f = 22Hz to 22kHz		99		
Noise	V _n	BW = 22Hz to 22kHz			30		μV _{RMS}
Capacitive-Load Drive	C _L	No sustained oscillations			200		pF
Crosstalk		L to R, R to L, R _L = 8Ω, FS = 0.707V _{RMS} , V _{OUT} = 70.7mV _{RMS} , 20kHz AES17, BW = 20Hz to 20kHz			-70		dB
Slew Rate	SR				1.4		V/μs
HEADPHONE AMPLIFIER							
Output Power	P _{OUT}	THD+N = 1%, f = 1kHz, T _A = +25°C	R _L = 16Ω		100		mW
			R _L = 32Ω		55		
Total Harmonic Distortion Plus Noise	THD+N	R _L = 32Ω, FS = 0.300V _{RMS} , V _{OUT} = 210mV _{RMS} , 20kHz AES17, BW = 20Hz to 20kHz			-77		dB FS
		R _L = 32Ω, P _{OUT} = 40mW, f = 1kHz			0.02		%
		R _L = 16Ω, P _{OUT} = 60mW, f = 1kHz			0.03		
		R _L = 10kΩ, FS = 0.707V _{RMS} , V _{OUT} = 500mV _{RMS} , 20kHz AES17, BW = 20Hz to 20kHz			-94		dB FS

Windows Vista-Compliant, Stereo Class AB Speaker Amplifiers and DirectDrive Headphone Amplifiers

ELECTRICAL CHARACTERISTICS (continued)

($V_{DD} = PV_{DD} = CPV_{DD} = HPV_{DD} = HP_EN = V_{LDO_EN}$ (MAX9789 only) = +5V, $V_{GND} = VP_{GND} = V_{CPGND} = \overline{SPKR_EN} = V_{LDO_SET}$ (MAX9789 only) = 0V, I_{LDO_OUT} (MAX9789 only) = 0, $C1 = C2 = C_{BIAS} = 1\mu F$, $R_L = \infty$, unless otherwise specified, $V_{GAIN1} = 0$, $V_{GAIN2} = 5V$ ($A_{VSP} = 10dB$, $A_{VHP} = 3.5dB$), $T_A = T_{MIN}$ to T_{MAX} , unless otherwise noted. Typical values are at $T_A = +25^\circ C$.) (Note 2)

PARAMETER	SYMBOL	CONDITIONS		MIN	TYP	MAX	UNITS
Power-Supply Rejection Ratio	PSRR	HPV _{DD} = 3V to 5.5V, T _A = +25°C		70	95		dB
		f = 1kHz, V _{RIPPLE} = 200mV _{P-P} (Note 4)			84		
		f = 10kHz, V _{RIPPLE} = 200mV _{P-P} (Note 4)			63		
Voltage Gain	A _V				3.5		dB
Input Impedance	R _{IN}	Measured at headphone amplifier inputs		20	40	80	kΩ
Output Offset Voltage	V _{OS}	T _A = +25°C			±2	±7	mV
			MAX9789C		±2	±10	
Click-and-Pop Level	K _{CP}	R _L = 32Ω, peak voltage, A-weighted, 32 samples per second (Notes 3, 4)	Into shutdown		-60		dBV
			Out of shutdown		-60		
Dynamic Range	DR	R _L = 32Ω, f = 1kHz, A-weighted, FS = 0.300V _{RMS} , V _{OUT} = 300μV _{RMS}			89		dB FS
		R _L = 10kΩ, f = 1kHz, A-weighted, FS = 0.707V _{RMS} , V _{OUT} = 707μV _{RMS}			97		
Signal-to-Noise Ratio	SNR	R _L = 32Ω, P _{OUT} = 60mW	22Hz to 22kHz		100		dB
			A-weighted		103		
Noise	V _n	BW = 22Hz to 22kHz			12		μV _{RMS}
Capacitive-Load Drive	C _L	No sustained oscillations			200		pF
Crosstalk		L to R, R to L, 20kHz AES17 BW = 20Hz to 20kHz	R _L = 32Ω, FS = 0.300V _{RMS} , V _{OUT} = 30mV _{RMS}		-74		dB
			R _L = 10kΩ, FS = 0.707V _{RMS} , V _{OUT} = 70.7mV _{RMS}		-77		
Slew Rate	SR				0.4		V/μs
Charge-Pump Frequency	f _{OSC}			500	550	625	kHz
		MAX9789C		475	550	625	
LOW-DROPOUT LINEAR REGULATOR							
Regulator Input Voltage Range	V _{DD}	Inferred from line regulation		4.5		5.5	V
Ground Current	I _{GND}	I _{OUT} = 0mA			0.1	0.4	mA
		I _{OUT} = 120mA			-40		
Output Current	I _{OUT}					120	mA
Crosstalk		V _{OUT} = 4.75V, I _{OUT} = 0mA, f = 1kHz, speaker P _{OUT} = 2W, speaker R _L = 4Ω			-95		dB
Fixed Output Voltage Accuracy		I _{OUT} = 1mA				±1.5	%
			MAX9789C				
Adjustable Output Voltage Range				1.21		4.75	V
LDO_SET Reference Voltage	V _{SET}			1.18	1.21	1.23	V
		MAX9789C		1.18	1.21	1.25	
LDO_SET Dual-Mode Threshold					200		mV

Windows Vista-Compliant, Stereo Class AB Speaker Amplifiers and DirectDrive Headphone Amplifiers

MAX9789/MAX9790

ELECTRICAL CHARACTERISTICS (continued)

(V_{DD} = PV_{DD} = CPV_{DD} = HPV_{DD} = HP_EN = V_{LDO_EN} (MAX9789 only) = +5V, V_{GND} = V_{PGND} = V_{CPGND} = $\overline{\text{SPKR_EN}}$ = V_{LDO_SET} (MAX9789 only) = 0V, I_{LDO_OUT} (MAX9789 only) = 0, C1 = C2 = C_{BIAS} = 1μF, R_L = ∞, unless otherwise specified, V_{GAIN1} = 0, V_{GAIN2} = 5V (A_{VSP} = 10dB, A_{VHP} = 3.5dB), T_A = T_{MIN} to T_{MAX}, unless otherwise noted. Typical values are at T_A = +25°C.) (Note 2)

PARAMETER	SYMBOL	CONDITIONS		MIN	TYP	MAX	UNITS
LDO_SET Input Bias Current (Note 5)	I _{SET}				±20	±500	nA
Dropout Voltage (Note 6)	V _{DO}	V _{OUT} = 4.75V (fixed output operation), T _A = +25°C	I _{OUT} = 50mA		25	50	mV
			I _{OUT} = 120mA		75	150	
Current Limit	I _{LIM}				300		mA
Startup Time					20		μs
Line Regulation		V _{IN} = 4.5V to 5.5V, LDO_OUT = 2.5V, I _{LDO_OUT} = 1mA		-4.8	+0.8	+4.8	mV/V
Load Regulation		V _{LDO_OUT} = 4.75V, 1mA < I _{LDO_OUT} < 120mA			0.2		mV/mA
Ripple Rejection		V _{RIPPLE} = 200mVp-p I _{LDO_OUT} = 10mA	f = 1kHz		59		dB
			f = 10kHz		42		
Output Voltage Noise		20Hz to 22kHz, C _{LDO_OUT} = 2 × 1μF, I _{LDO_OUT} = 120mA			125		μVRMS
DIGITAL INPUTS (SPKR_EN, HP_EN, MUTE, GAIN1, GAIN2, LDO_EN (MAX9789 Only))							
Input-Voltage High	V _{INH}			2			V
Input-Voltage Low	V _{INL}					0.8	V
Input Bias Current						±1	μA

Note 2: All devices are 100% production tested at room temperature. All temperature limits are guaranteed by design.

Note 3: Specified at room temperature with an 8Ω resistive load connected across BTL output for speaker amplifier. Specified at room temperature with a 32Ω resistive load connected between HPR, HPL, and GND for headphone amplifier. Speaker and headphone mode transitions are controlled by $\overline{\text{SPKR_EN}}$ and HP_EN control pins, respectively.

Note 4: Amplifier inputs AC-coupled to GND.

Note 5: Maximum value is due to test limitations.

Note 6: V_{LDO_OUT} = V_{LDO_OUTNOMINAL} - 2%.

Windows Vista-Compliant, Stereo Class AB Speaker Amplifiers and DirectDrive Headphone Amplifiers

Typical Operating Characteristics

($V_{DD} = PV_{DD} = CPV_{DD} = HPV_{DD} = LDO_EN = +5V$, $V_{GND} = VP_{GND} = V_{CPGND} = VLDO_SET = 0V$, $C1 = C2 = C_{BIAS} = C_{IN} = 1\mu F$, $R_L = \infty$, unless otherwise specified, $GAIN1 = 0$, $GAIN2 = 1$ ($A_{VSP} = 10dB$, $A_{VHP} = 3.5dB$), measurement BW = 20kHz AES17, $T_A = +25^\circ C$, unless otherwise noted. Headphone mode: $SPKR_EN = 1$, $HP_EN = 0$. Speaker mode: $SPKR_EN = 0$, $HP_EN = 1$.)

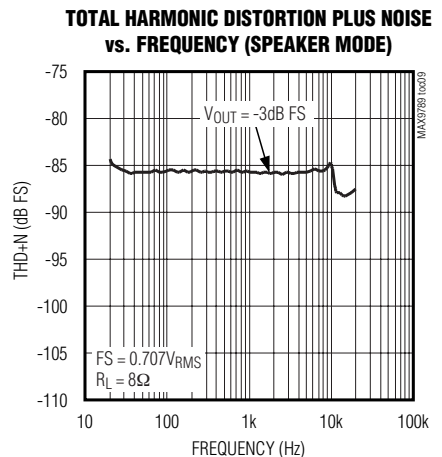
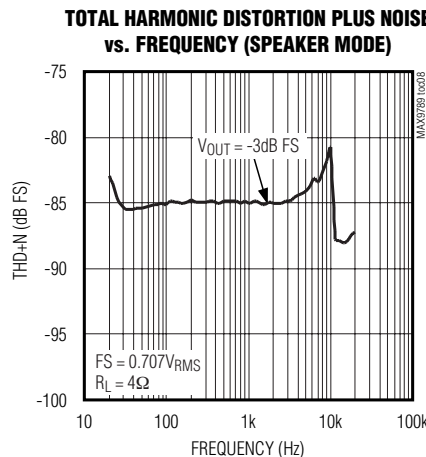
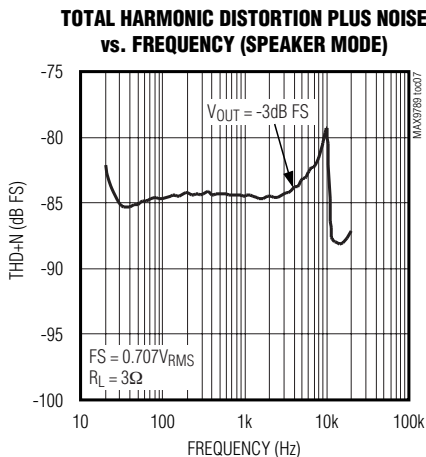
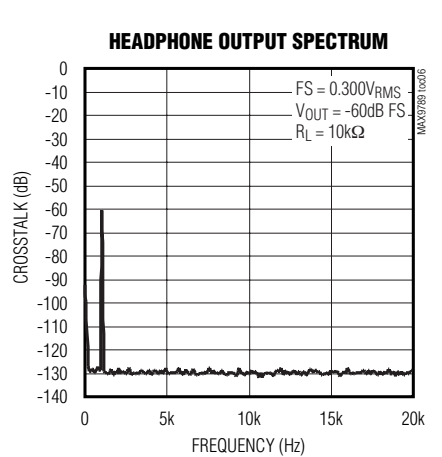
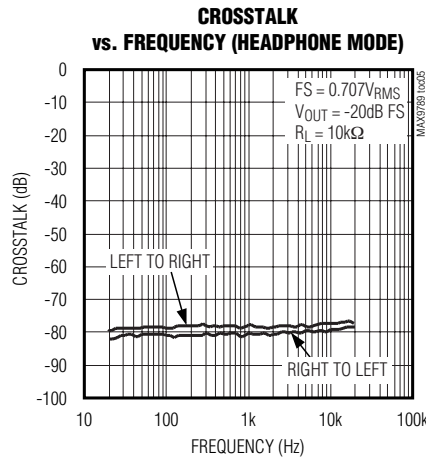
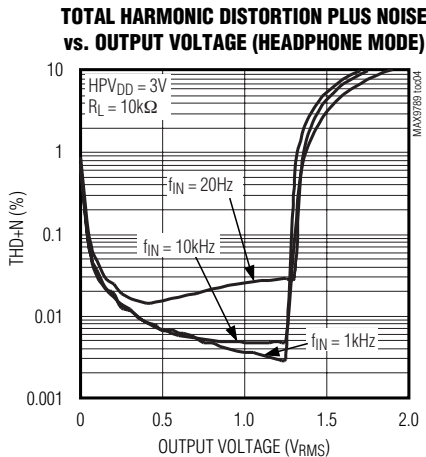
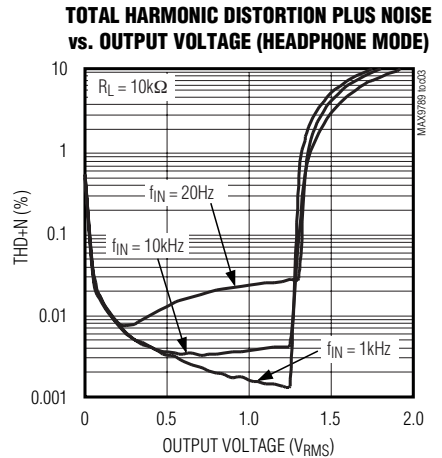
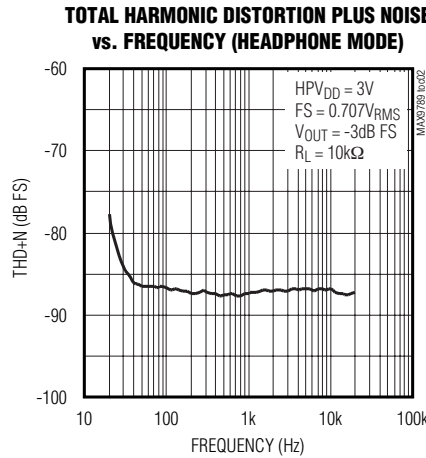
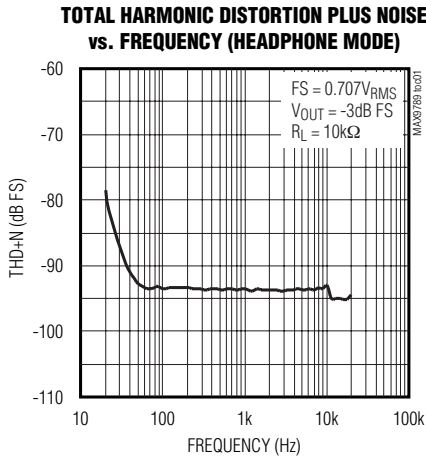

Windows Vista-Compliant, Stereo Class AB Speaker Amplifiers and DirectDrive Headphone Amplifiers

MAX9789/MAX9790

Typical Operating Characteristics (continued)

($V_{DD} = PV_{DD} = CPV_{DD} = HPV_{DD} = LDO_EN = +5V$, $V_{GND} = V_{PGND} = V_{CPGND} = V_{LDO_SET} = 0V$, $C1 = C2 = C_{BIAS} = C_{IN} = 1\mu F$, $R_L = \infty$, unless otherwise specified, $GAIN1 = 0$, $GAIN2 = 1$ ($A_{VSP} = 10dB$, $A_{VHP} = 3.5dB$), measurement BW = 20kHz AES17, $T_A = +25^\circ C$, unless otherwise noted. Headphone mode: $\overline{SPKR_EN} = 1$, $HP_EN = 0$. Speaker mode: $\overline{SPKR_EN} = 0$, $HP_EN = 1$.)

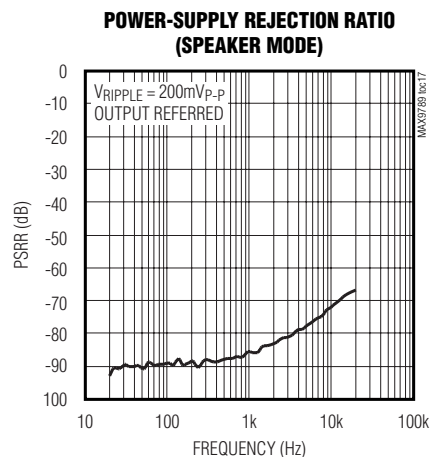
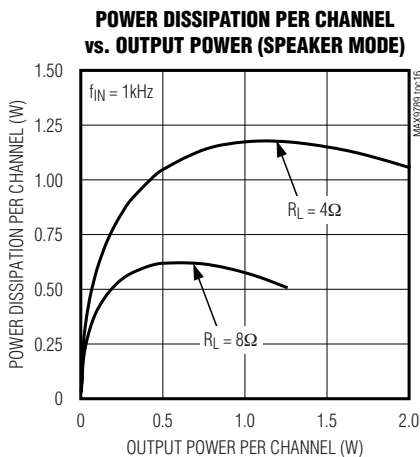
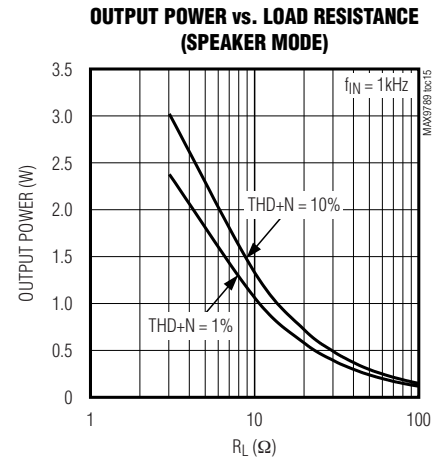
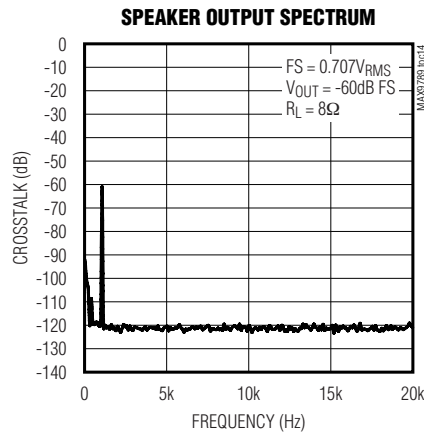
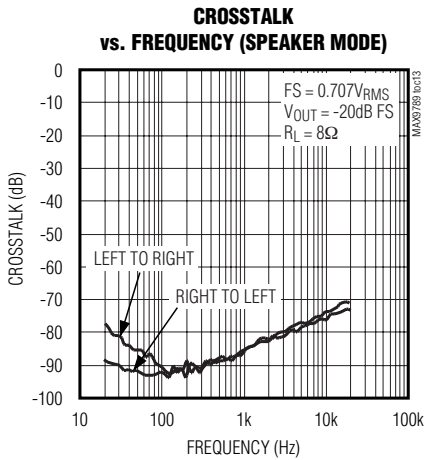
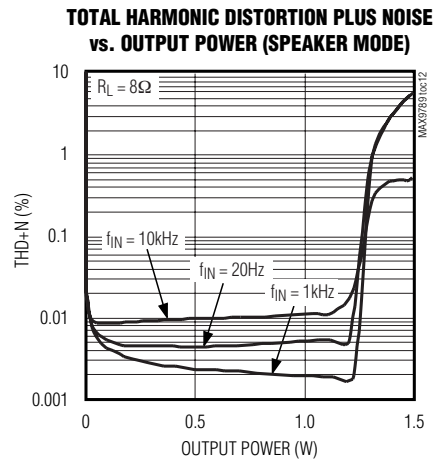
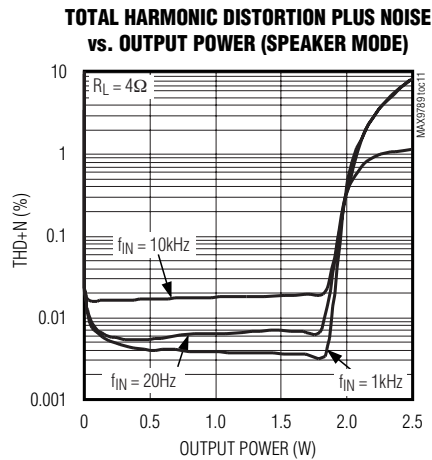
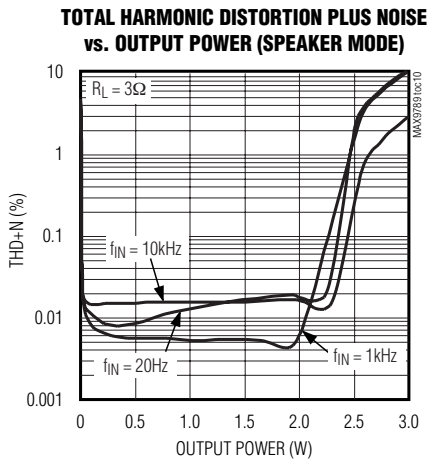

Windows Vista-Compliant, Stereo Class AB Speaker Amplifiers and DirectDrive Headphone Amplifiers

Typical Operating Characteristics (continued)

($V_{DD} = PV_{DD} = CPV_{DD} = HPV_{DD} = LDO_EN = +5V$, $V_{GND} = V_{PGND} = V_{CPGND} = V_{LDO_SET} = 0V$, $C1 = C2 = C_{BIAS} = C_{IN} = 1\mu F$, $R_L = \infty$, unless otherwise specified, $GAIN1 = 0$, $GAIN2 = 1$ ($A_{VSP} = 10dB$, $A_{VHP} = 3.5dB$), measurement BW = 20kHz AES17, $T_A = +25^\circ C$, unless otherwise noted. Headphone mode: $\overline{SPKR_EN} = 1$, $HP_EN = 0$. Speaker mode: $\overline{SPKR_EN} = 0$, $HP_EN = 1$.)

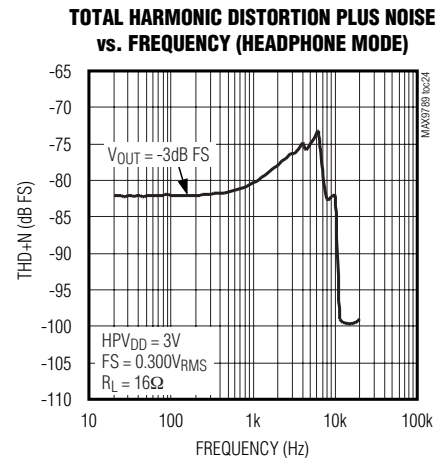
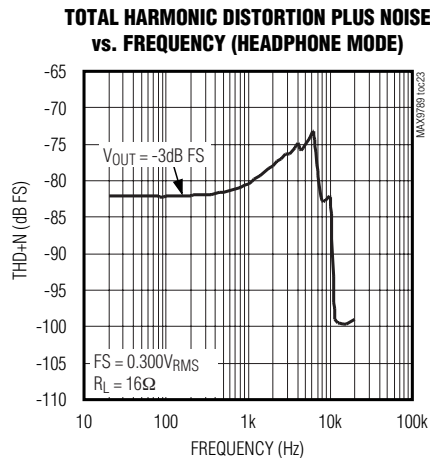
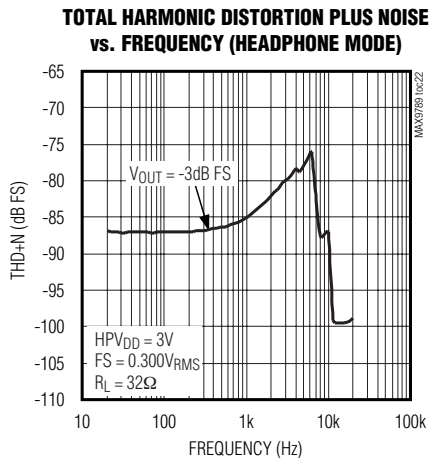
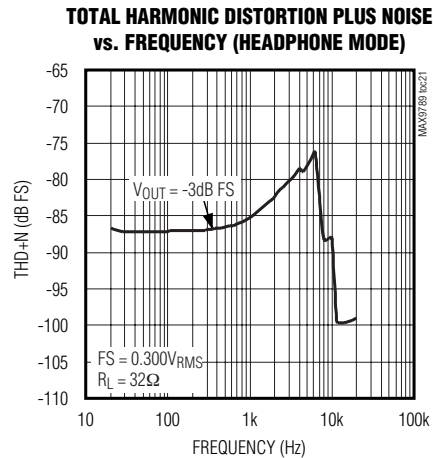
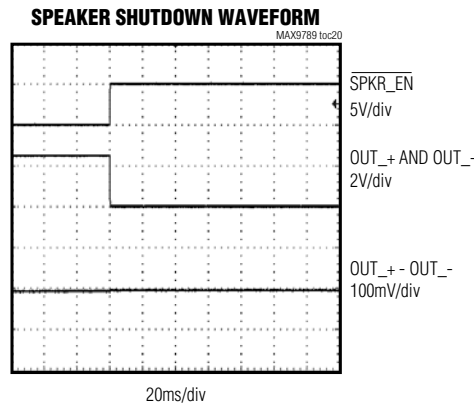
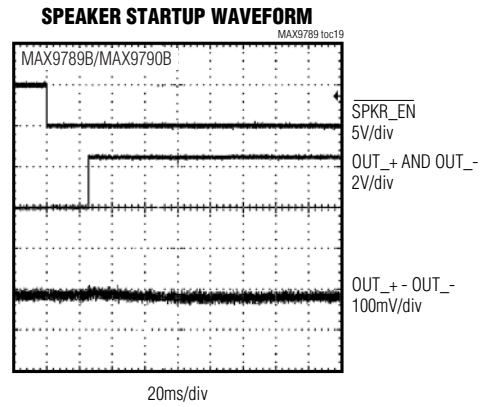
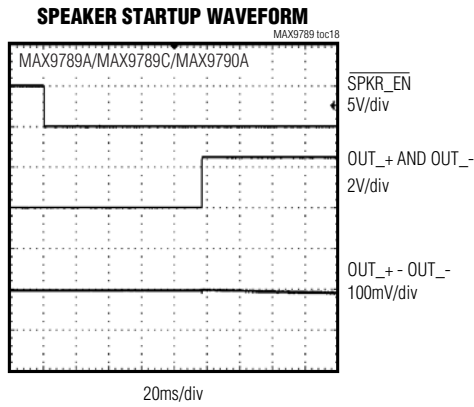

Windows Vista-Compliant, Stereo Class AB Speaker Amplifiers and DirectDrive Headphone Amplifiers

Typical Operating Characteristics (continued)

($V_{DD} = PV_{DD} = CPV_{DD} = HPV_{DD} = LDO_EN = +5V$, $V_{GND} = V_{PGND} = V_{CPGND} = V_{LDO_SET} = 0V$, $C1 = C2 = C_{BIAS} = C_{IN} = 1\mu F$, $R_L = \infty$, unless otherwise specified, $GAIN1 = 0$, $GAIN2 = 1$ ($A_{VSP} = 10dB$, $A_{VHP} = 3.5dB$), measurement BW = 20kHz AES17, $T_A = +25^\circ C$, unless otherwise noted. Headphone mode: $\overline{SPKR_EN} = 1$, $HP_EN = 0$. Speaker mode: $\overline{SPKR_EN} = 0$, $HP_EN = 1$.)

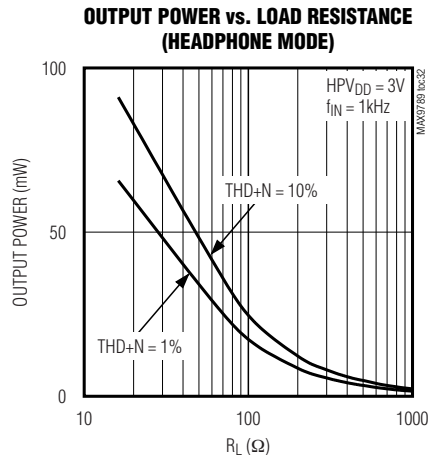
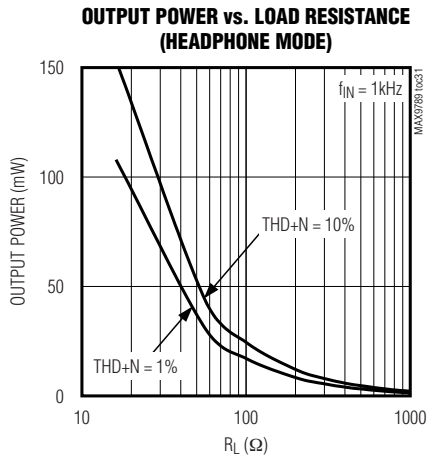
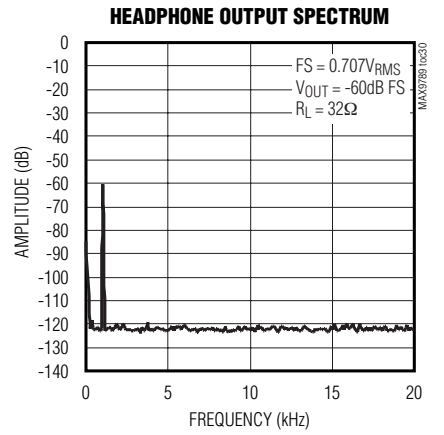
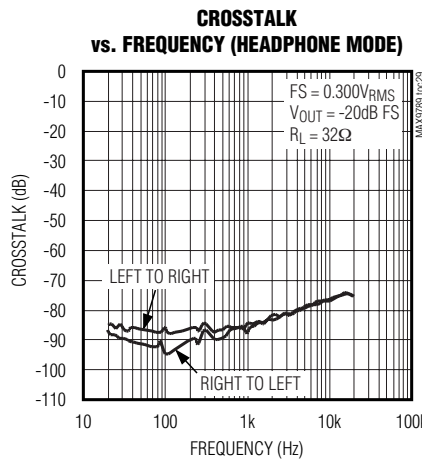
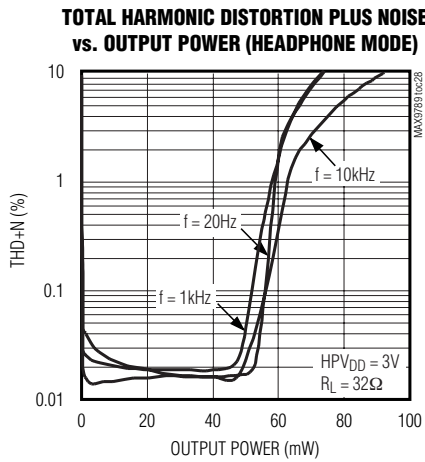
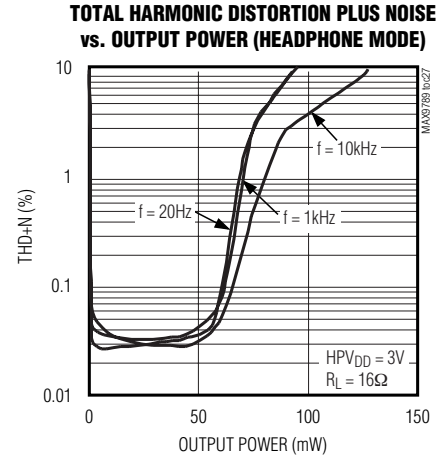
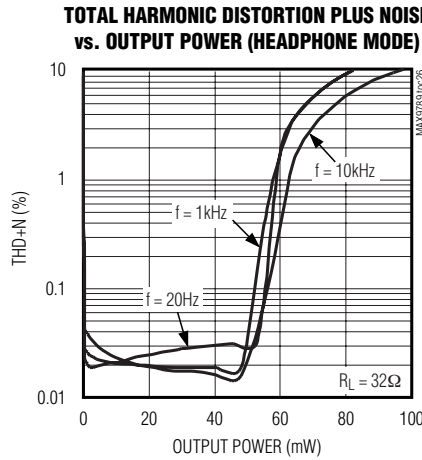
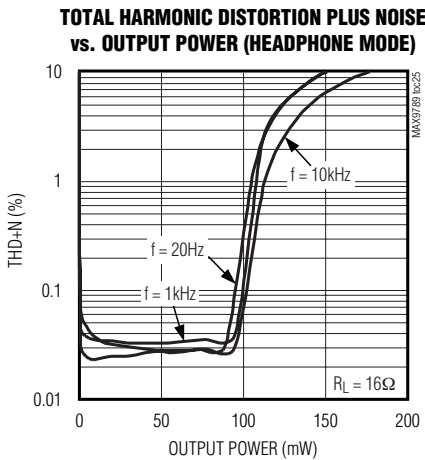

Windows Vista-Compliant, Stereo Class AB Speaker Amplifiers and DirectDrive Headphone Amplifiers

Typical Operating Characteristics (continued)

($V_{DD} = PV_{DD} = CPV_{DD} = HPV_{DD} = LDO_EN = +5V$, $V_{GND} = VP_{GND} = V_{CPGND} = VLDO_SET = 0V$, $C1 = C2 = C_{BIAS} = C_{IN} = 1\mu F$, $R_L = \infty$, unless otherwise specified, $GAIN1 = 0$, $GAIN2 = 1$ ($A_{VSP} = 10dB$, $A_{VHP} = 3.5dB$), measurement BW = 20kHz AES17, $T_A = +25^\circ C$, unless otherwise noted. Headphone mode: $SPKR_EN = 1$, $HP_EN = 0$. Speaker mode: $SPKR_EN = 0$, $HP_EN = 1$.)

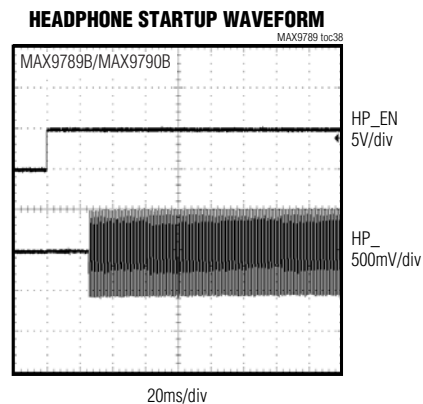
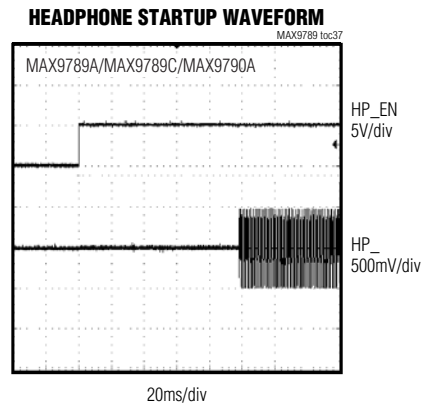
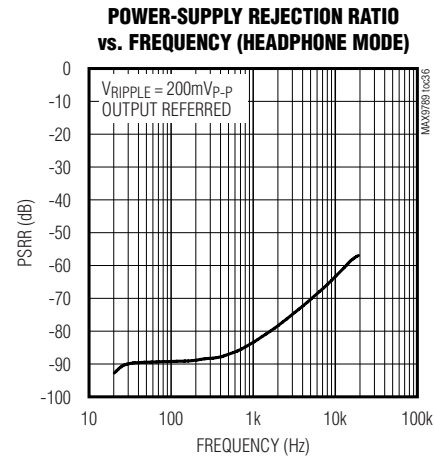
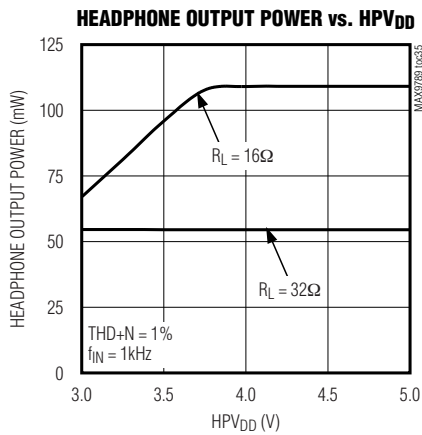
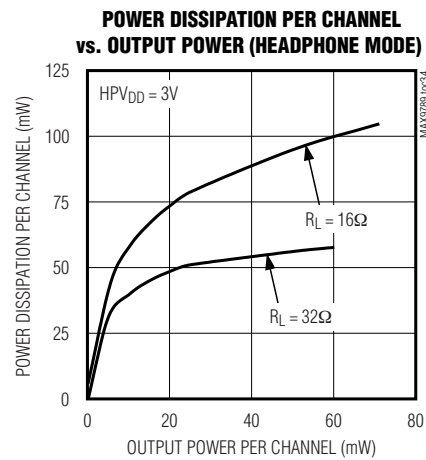
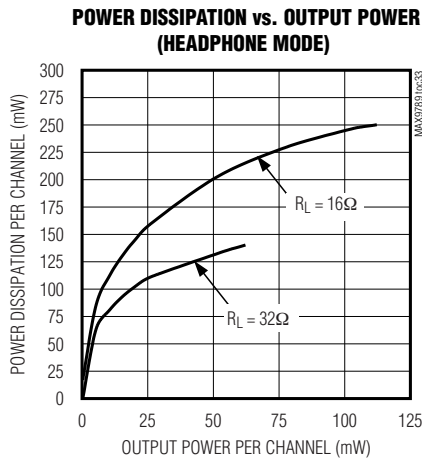

Windows Vista-Compliant, Stereo Class AB Speaker Amplifiers and DirectDrive Headphone Amplifiers

Typical Operating Characteristics (continued)

($V_{DD} = PV_{DD} = CPV_{DD} = HPV_{DD} = LDO_EN = +5V$, $V_{GND} = VP_{GND} = V_{CPGND} = VLDO_SET = 0V$, $C1 = C2 = C_{BIAS} = C_{IN} = 1\mu F$, $R_L = \infty$, unless otherwise specified, $GAIN1 = 0$, $GAIN2 = 1$ ($A_{VSP} = 10dB$, $A_{VHP} = 3.5dB$), measurement BW = 20kHz AES17, $T_A = +25^\circ C$, unless otherwise noted. Headphone mode: $\overline{SPKR_EN} = 1$, $HP_EN = 0$. Speaker mode: $\overline{SPKR_EN} = 0$, $HP_EN = 1$.)

HEADPHONE SHUTDOWN WAVEFORM

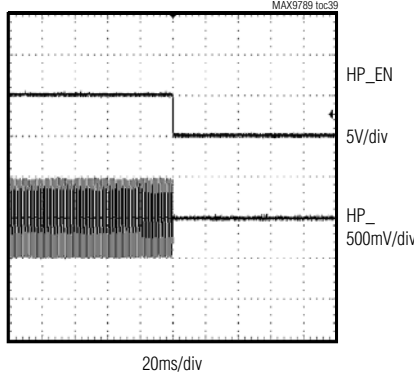

SUPPLY CURRENT vs. SUPPLY VOLTAGE

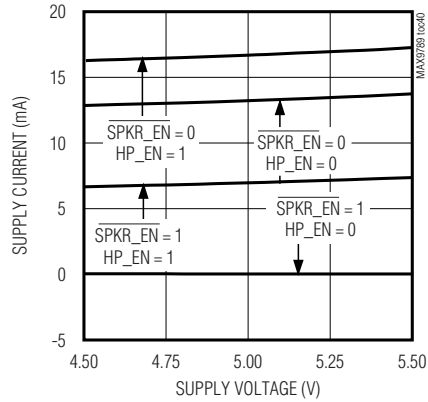

SHUTDOWN CURRENT vs. SUPPLY VOLTAGE

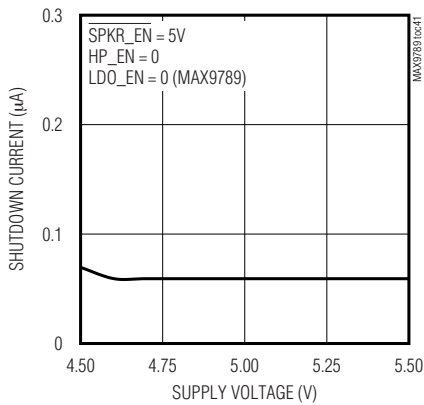

LDO OUTPUT VOLTAGE ACCURACY vs. I_{LOAD}

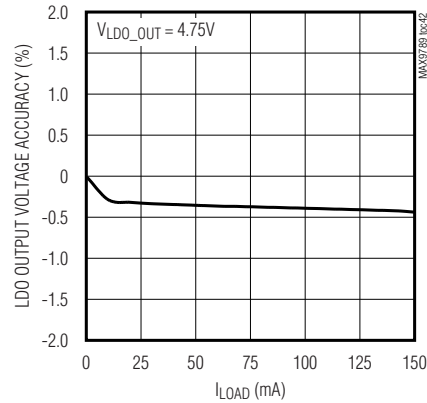

LDO OUTPUT VOLTAGE ACCURACY vs. AMPLIFIER OUTPUT POWER

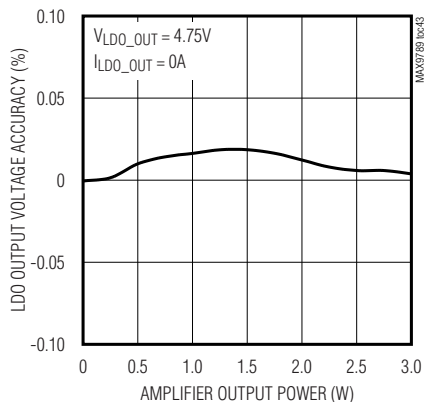

LDO OUTPUT VOLTAGE ACCURACY vs. TEMPERATURE

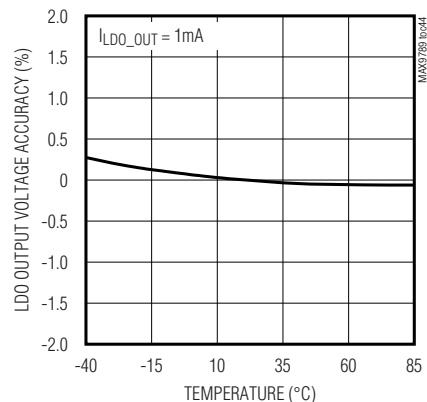

Windows Vista-Compliant, Stereo Class AB Speaker Amplifiers and DirectDrive Headphone Amplifiers

Typical Operating Characteristics (continued)

($V_{DD} = PV_{DD} = CPV_{DD} = HPV_{DD} = LDO_EN = +5V$, $V_{GND} = V_{PGND} = V_{CPGND} = V_{LDO_SET} = 0V$, $C1 = C2 = C_{BIAS} = C_{IN} = 1\mu F$, $R_L = \infty$, unless otherwise specified, $GAIN1 = 0$, $GAIN2 = 1$ ($A_{VSP} = 10dB$, $A_{VHP} = 3.5dB$), measurement BW = 20kHz AES17, $T_A = +25^\circ C$, unless otherwise noted. Headphone mode: $SPKR_EN = 1$, $HP_EN = 0$. Speaker mode: $SPKR_EN = 0$, $HP_EN = 1$.)

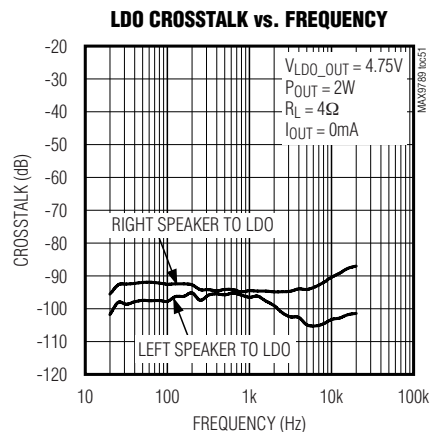
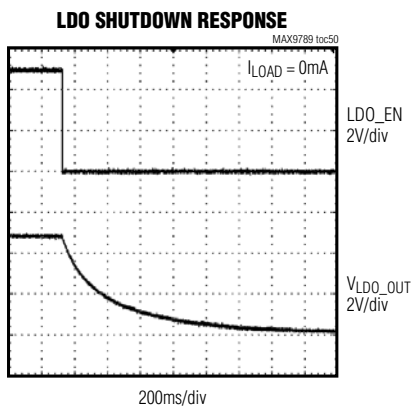
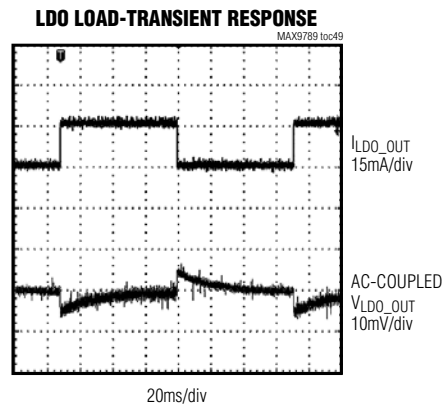
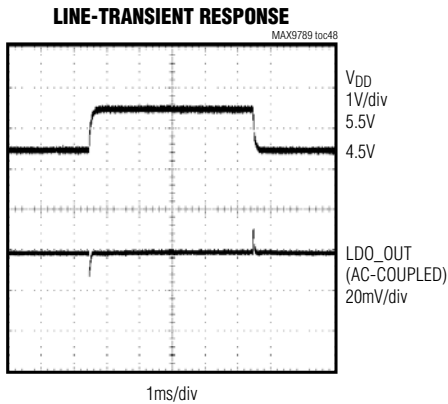
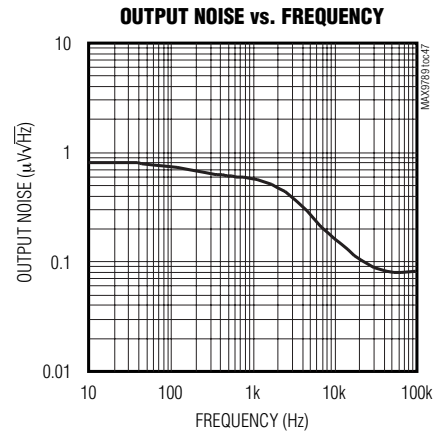
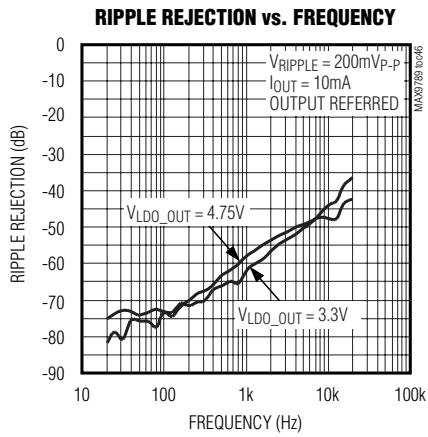
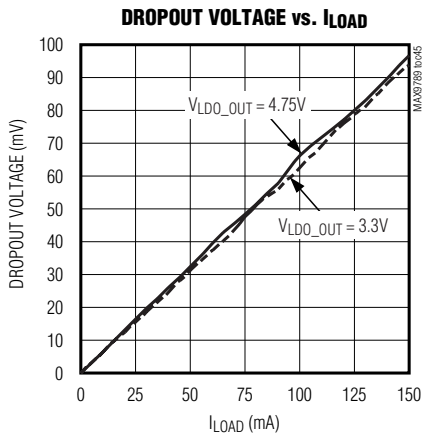

Windows Vista-Compliant, Stereo Class AB Speaker Amplifiers and DirectDrive Headphone Amplifiers

Pin Description

MAX9789/MAX9790

PIN		NAME	FUNCTION
MAX9789	MAX9790		
1	—	LDO_SET	Regulator Feedback Input. Connect to GND for 4.75V fixed output. Connect to a resistor-divider for adjustable output. See Figure 1.
2	2	SPKR_INR	Right-Channel Speaker Amplifier Input
3	3	SPKR_INL	Left-Channel Speaker Amplifier Input
4	—	LDO_EN	LDO Enable. Connect LDO_EN to V _{DD} to enable the LDO.
5, 21	5, 21	PGND	Power Ground. Star-connect to GND.
6	6	OUTL+	Left-Channel Speaker Amplifier Output, Positive Phase
7	7	OUTL-	Left-Channel Speaker Amplifier Output, Negative Phase
8, 18	8, 18	PV _{DD}	Speaker Amplifier Power-Supply Input. Bypass with a 0.1μF capacitor to PGND.
9	9	CPV _{DD}	Charge-Pump Power Supply. Connect a 1μF capacitor between CPV _{DD} and PGND.
10	10	C1P	Charge-Pump Flying Capacitor Positive Terminal. Connect a 1μF capacitor between C1P to C1N.
11	11	CPGND	Charge-Pump Ground. Connect directly to PGND plane.
12	12	C1N	Charge-Pump Flying Capacitor Negative Terminal. Connect a 1μF capacitor between C1P to C1N.
13	13	CPV _{SS}	Charge-Pump Output. Connect to PV _{SS} .
14	14	PV _{SS}	Headphone Amplifier Negative Power Supply. Connect a 1μF capacitor between PV _{SS} and PGND.
15	15	HPR	Right-Channel Headphone Amplifier Output
16	16	HPL	Left-Channel Headphone Amplifier Output
17	17	HPV _{DD}	Headphone Amplifier Positive Power Supply. Connect a 10μF capacitor between HPV _{DD} and PGND.
19	19	OUTR-	Right-Channel Speaker Amplifier Output, Negative Phase
20	20	OUTR+	Right-Channel Speaker Amplifier Output, Positive Phase
22	22	HP_EN	Active-High Headphone Amplifier Enable
23	23	$\overline{\text{SPKR_EN}}$	Active-Low Speaker Amplifier Enable
24	24	BIAS	Common-Mode Bias Voltage. Bypass with a 1μF capacitor to GND.
25	25	$\overline{\text{MUTE}}$	Active-Low Mute Enable. Mutes speaker and headphone amplifiers.
26	26	HP_INR	Right-Channel Headphone Amplifier Input
27	27	HP_INL	Left-Channel Headphone Amplifier Input
28	4, 28	GND	Signal Ground. Star-connect to PGND.
29	—	LDO_OUT	LDO Output. Bypass with two 1μF capacitors to GND.
30	30	V _{DD}	Positive Power Supply and LDO Input (MAX9789). Bypass with one 0.1μF capacitor and two 1μF capacitors to GND (MAX9789). Bypass with one 0.1μF capacitor and one 1μF capacitor to GND (MAX9790).
31	31	GAIN1	Speaker Amplifier Gain Select 1
32	32	GAIN2	Speaker Amplifier Gain Select 2
—	1, 29	N.C.	No Connection. Not internally connected.
EP	EP	EP	Exposed Paddle. Connect to GND.

Windows Vista-Compliant, Stereo Class AB Speaker Amplifiers and DirectDrive Headphone Amplifiers

Detailed Description

The MAX9789/MAX9790 combine a 2W BTL speaker amplifier with an 100mW DirectDrive headphone amplifier. These devices feature comprehensive click-and-pop suppression and programmable four-level speaker amplifier gain control. The MAX9789/MAX9790 feature high +90dB PSRR, low 0.002% THD+N, industry-leading click-and-pop performance, low-power shutdown mode, and excellent RF immunity. The MAX9789 incorporates an integrated LDO that serves as a clean power supply for a CODEC or other circuits.

The MAX9789/MAX9790 is Microsoft Windows Vista compliant. See Table 1 for a comparison of the Microsoft Windows Vista premium mobile specifications and MAX9789/MAX9790 specifications.

The speaker amplifiers use BTL architecture, doubling the voltage drive to the speakers and eliminating the need for DC-blocking capacitors. The output consists of two signals, identical in magnitude, but 180° out of phase.

The headphone amplifiers use Maxim's patented DirectDrive architecture to eliminate the bulky output DC-blocking capacitors required by traditional headphone amplifiers. A charge pump inverts a positive supply (CPVDD) to create a negative supply (CPVSS). The headphone amplifiers operate from these bipolar supplies with their outputs biased about GND. The benefit of the GND bias is that the amplifier outputs no longer have a DC component (typically $V_{DD} / 2$). This feature eliminates the large DC-blocking capacitors

required with conventional headphone amplifiers to conserve board space and system cost, as well as improve low-frequency response.

The MAX9789/MAX9790 feature programmable speaker amplifier gain, allowing the speaker gain to be set by the logic voltages applied to GAIN1 and GAIN2, while the headphone amplifiers feature a fixed 3.5dB gain. Both amplifiers feature an undervoltage lockout that prevents operation from an insufficient power supply and click-and-pop suppression that eliminates audible transients on startup and shutdown. The amplifiers include thermal overload and short-circuit protection. An additional feature of the speaker amplifiers is that there is no phase inversion from input to output.

Low-Dropout Linear Regulator (MAX9789 Only)

The MAX9789's low-dropout (LDO) linear regulator can be used to provide a clean power supply to a CODEC or other circuitry. The LDO can be enabled independently of the audio amplifiers. Set LDO_EN = VDD to enable the LDO or set LDO_EN = GND to disable the LDO. The LDO is capable of providing up to 120mA continuous current and features Maxim's Dual Mode™ feedback, easily enabling a fixed 4.75V output or a user-adjustable output. When LDO_SET is connected to GND, the output is internally set to 4.75V. The output voltage can be adjusted from 1.21V to 4.75V by connecting two external resistors as a voltage divider, at LDO_SET (Figure 1).

Table 1. Windows Premium Mobile Vista Specifications vs. MAX9789/MAX9790 Specifications

DEVICE TYPE	REQUIREMENT	WINDOWS PREMIUM MOBILE Vista SPECIFICATIONS	MAX9789/MAX9790 TYPICAL PERFORMANCE
Analog Line Output Jack ($R_L = 10k\Omega$, $FS = 0.707V_{RMS}$)	THD+N	≤ -65 dB FS [20Hz, 20kHz]	-94dB FS [20Hz, 20kHz]
	Dynamic range with signal present	≤ -80 dB FS, A-weighted	-97dB FS, A-weighted
	Line output crosstalk	≤ -50 dB [20Hz, 20kHz]	-77dB [20Hz, 20kHz]
Analog Headphone Out Jack ($R_L = 32\Omega$, $FS = 0.300V_{RMS}$)	THD+N	≤ -45 dB FS [20Hz, 20kHz]	-77dB FS [20Hz, 20kHz]
	Dynamic range with signal present	≤ -60 dB FS, A-weighted	-89dB FS, A-weighted
	Headphone output crosstalk	≤ -50 dB [20Hz, 20kHz]	-74dB [20Hz, 20kHz]

Note: THD+N, DYNAMIC RANGE, and CROSSTALK should be measured in accordance with AES-17 audio measurements standards.

Dual Mode is a trademark of Maxim Integrated Products, Inc.

Windows Vista-Compliant, Stereo Class AB Speaker Amplifiers and DirectDrive Headphone Amplifiers

The output voltage is set by the following equation:

$$V_{LDO_OUT} = V_{LDO_SET} \left(1 + \frac{R1}{R2} \right)$$

where $V_{LDO_SET} = 1.21V$.

To simplify resistor selection:

$$R1 = R2 \left(\frac{V_{LDO_OUT}}{1.21} - 1 \right)$$

Since the input bias current at LDO_SET is typically less than 500nA (max), large resistance values can be used for R1 and R2 to minimize power consumption without compromising accuracy. The parallel combination of R1 and R2 should be less than 1MΩ.

DirectDrive

Conventional single-supply headphone amplifiers have their outputs biased about a nominal DC voltage ($V_{DD} / 2$) for maximum dynamic range. Large coupling capacitors are needed to block this DC bias from the headphones. Without these capacitors, a significant amount of DC current flows to the headphone, resulting in unnecessary power dissipation and possible damage to both headphone and headphone amplifier.

Maxim's patented DirectDrive architecture uses a charge pump to create an internal negative supply voltage. It allows the MAX9789/MAX9790 headphone amplifier output to be biased about GND. With no DC component, there is no need for the large DC-blocking

capacitors. Instead of two large capacitors (330μF typically required to meet Vista magnitude response specifications), the MAX9789/MAX9790 charge pump requires only two small 1μF ceramic capacitors, conserving board space, reducing cost, and improving the low-frequency response of the headphone amplifier.

Previous attempts to eliminate the output coupling capacitors involved biasing the headphone return (sleeve) to the DC bias voltage of the headphone amplifiers. This method raised some issues:

- The sleeve is typically grounded to the chassis. Using this biasing approach, the sleeve must be isolated from system ground, complicating product design.
- During an ESD strike, the amplifier's ESD structures are the only path to system ground. The amplifier must be able to withstand the full ESD strike.
- When using the headphone jack as a line out to other equipment, the bias voltage on the sleeve may conflict with the ground potential from other equipment, resulting in large ground loop current and possible damage to the amplifiers.

Low-Frequency Response

In addition to the cost and size disadvantages, the DC-blocking capacitors limit the low-frequency response of the amplifier and distort the audio signal:

- The impedance of the headphone load and the DC-blocking capacitor form a highpass filter with the -3dB point determined by:

$$f_{-3dB} = \frac{1}{2\pi R_L C_{OUT}}$$

where R_L is the impedance of the headphone and C_{OUT} is the value of the DC-blocking capacitor.

- The highpass filter is required by conventional single-ended, single-supply headphone amplifier to block the midrail DC component of the audio signal from the headphones. Depending on the -3dB point, the filter can attenuate low-frequency signals within the audio band. Larger values of C_{OUT} reduce the attenuation, but are physically larger, more expensive capacitors. Figure 2 shows the relationship between the size of C_{OUT} and the resulting low-frequency attenuation. Note the Vista's magnitude response specification calls for a -3dB point at 20Hz at the headphone jack. The -3dB point at 20Hz for a 32Ω headphone requires a 330μF blocking capacitor (Table 2).

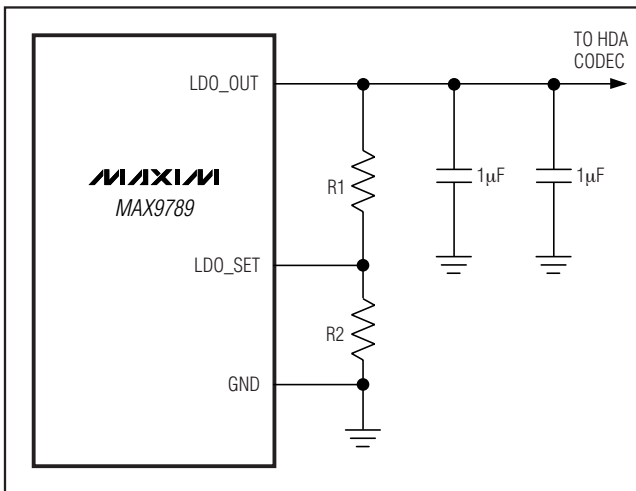

Figure 1. Adjustable Output Using External Feedback Resistors.

Windows Vista-Compliant, Stereo Class AB Speaker Amplifiers and DirectDrive Headphone Amplifiers

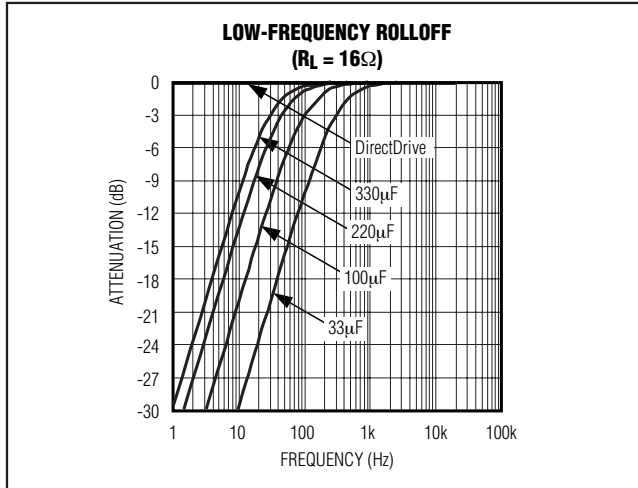

Figure 2. Low-Frequency Attenuation of Common DC-Blocking Capacitor Values

- The voltage coefficient of the capacitor, the change in capacitance due to a change in the voltage across the capacitor, distorts the audio signal. At frequencies around the -3dB point, this effect is maximized and the voltage coefficient appears as frequency-dependent distortion. Figure 3 shows the THD+N introduced by two different capacitor dielectrics. Note that around the -3dB point, THD+N increases dramatically.
- The combination of low-frequency attenuation and frequency-dependent distortion compromises audio reproduction. DirectDrive improves low-frequency reproduction in portable audio equipment that emphasizes low-frequency effects, such as multimedia laptops, MP3, CD, and DVD players (See Table 2).

Table 2. Low-Frequency Rolloff

C _{OUT} (μF)	f _{-3dB} (Hz)	
	R _L = 16Ω	R _L = 32Ω
22	452	226
33	301	151
100	99	50
220	45	23
330*	30	15
470	21	11

*Vista requirement for 32Ω load.

Charge Pump

The MAX9789/MAX9790 feature a low-noise charge pump. The 550kHz switching frequency is well beyond the audio range, and does not interfere with the audio signals. The switch drivers feature a controlled switching

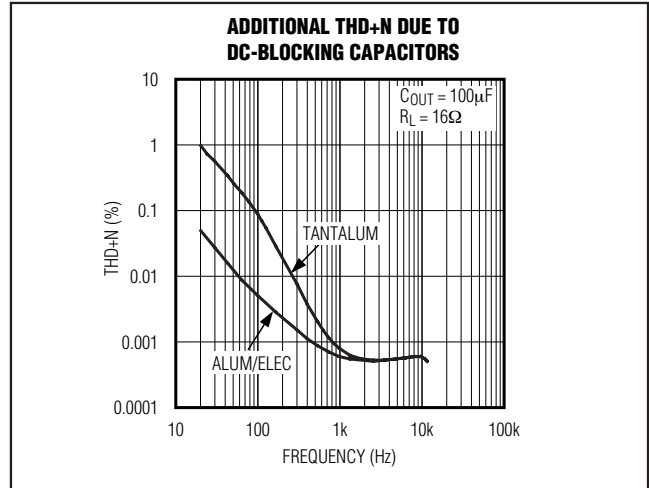

Figure 3. Distortion Contributed by DC-Blocking Capacitors

speed that minimizes noise generated by switching transients. Limiting the switching speed of the charge pump minimizes the di/dt noise caused by the parasitic bond wire and trace inductance.

BIAS

The MAX9789/MAX9790 feature an internally generated, power-supply independent, common-mode bias voltage of 1.8V referenced to GND. BIAS provides both click-and-pop suppression and sets the DC bias level for the amplifiers. The BIAS pin should be bypassed to GND with a 1μF capacitor. No external load should be applied to BIAS. Any load lowers the BIAS voltage, affecting the overall performance of the device.

Headphone and Speaker Amplifier Gain

The MAX9789/MAX9790 feature programmable speaker amplifier gain, set by the logic voltages applied to pins GAIN1 and GAIN2. Table 3 shows the logic combinations that can be applied to pins GAIN1 and GAIN2 and their affects on the speaker amplifier gain. The headphone amplifier gain is fixed at 3.5dB.

Table 3. MAX9789/MAX9790 Programmable Gain Settings

MAX9789/MAX9790			
GAIN1	GAIN2	SPEAKER MODE GAIN (dB)	HEADPHONE MODE GAIN (dB)
0	0	6	3.5
0	1	10	3.5
1	0	15.6	3.5
1	1	21.6	3.5

Windows Vista-Compliant, Stereo Class AB Speaker Amplifiers and DirectDrive Headphone Amplifiers

Speaker and Headphone Amplifier Enable

The MAX9789/MAX9790 feature control inputs for the independent enabling of the speaker and headphone amplifiers, allowing both to be active simultaneously if required. Driving SPKR_EN high disables the speaker amplifiers. Driving HP_EN low independently disables the headphone amplifiers. For applications that require only one of the amplifiers to be on at a given time, SPKR_EN and HP_EN can be tied together allowing a single logic voltage to enable either the speaker or the headphone amplifier as shown in Figure 4.

MUTE

The MAX9789/MAX9790 allow for the speaker and headphone amplifiers to be muted. By driving MUTE low, both the speaker and headphone amplifiers are muted. When muted, the speaker outputs remain biased at $V_{DD} / 2$.

Shutdown

The MAX9789/MAX9790 feature a low-power shutdown mode, drawing 0.3µA of supply current. By disabling the speaker, headphone amplifiers and the LDO (for MAX9789), the MAX9789/MAX9790 enter low-power shutdown mode. Set SPKR_EN to V_{DD} and HP_EN and LDO_EN to GND to disable the speaker amplifiers, headphone amplifiers, and LDO, respectively.

Click-and-Pop Suppression

Speaker Amplifier

The MAX9789/MAX9790 speaker amplifiers feature Maxim's comprehensive, industry-leading click-and-pop suppression. During startup, the click-and-pop suppression circuitry eliminates any audible transient sources internal to the device. When entering shutdown, the differential speaker outputs ramp to GND quickly and simultaneously.

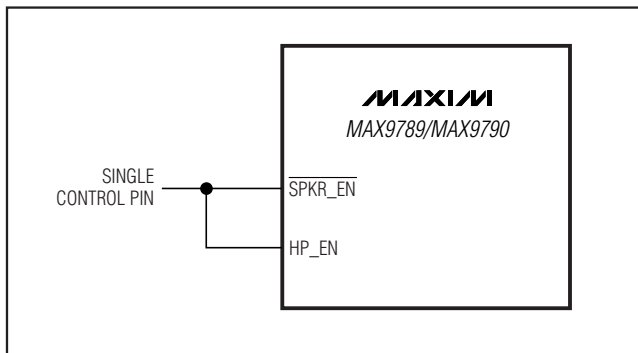

Figure 4. Enabling Either the Speaker or Headphone Amplifier with a Single Control Pin

Headphone Amplifier

In conventional single-supply headphone amplifiers, the output-coupling capacitor is a major contributor of audible clicks and pops. Upon startup, the amplifier charges the coupling capacitor to its bias voltage, typically $V_{DD} / 2$. Likewise, during shutdown, the capacitor is discharged to GND. A DC shift across the capacitor results, which in turn, appears as an audible transient at the headphone. Since the MAX9789/MAX9790 do not require output-coupling capacitors, no audible transient occurs.

Additionally, the MAX9789/MAX9790 features extensive click-and-pop suppression that eliminates any audible transient sources internal to the device. The startup/shutdown waveform in the *Typical Operating Characteristics* shows that there are minimal spectral components in the audible range at the output.

Applications Information

BTL Speaker Amplifiers

The MAX9789/MAX9790 feature speaker amplifiers designed to drive a load differentially, a configuration referred to as bridge-tied load (BTL). The BTL configuration (Figure 5) offers advantages over the single-ended configuration, where one side of the load is connected to ground. Driving the load differentially doubles the output voltage compared to a single-ended amplifier operating under similar conditions. The doubling of the output voltage yields four times the output power at the load.

Since the differential outputs are biased at mid-supply, there is no net DC voltage across the load. This eliminates the need for DC-blocking capacitors required for single-ended amplifiers. These capacitors can be large, expensive, consume board space, and degrade low-frequency performance.

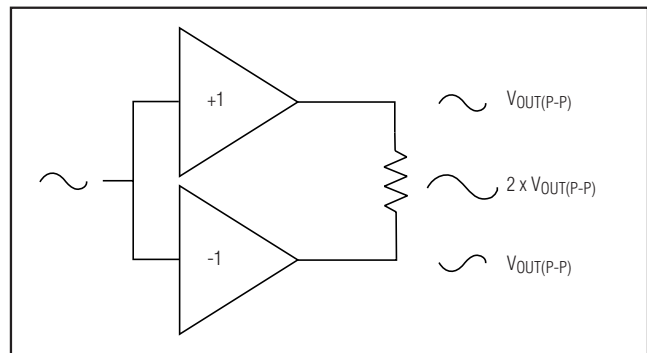

Figure 5. Bridge-Tied Load Configuration

Windows Vista-Compliant, Stereo Class AB Speaker Amplifiers and DirectDrive Headphone Amplifiers

Mono Speaker Configuration

The MAX9789 stereo BTL Class AB speaker amplifier can be configured to drive a mono speaker. Rather than combining the CODEC's left- and right-input signals in a resistive network prior to one channel of the speaker amplifier input, the transducer itself can be connected to the BTL speaker amplifier output as shown in Figure 6. When compared to the resistive network implementation, the configuration in Figure 6 will:

- 1) Eliminate noise pickup by eliminating the high-impedance node at the CODEC's left- and right-signal mixing point. SNR performance will be improved as a result.
- 2) Eliminate gain error by eliminating any resistive mismatch between the external resistance used to sum the left and right signals and the MAX9789 internal resistance.

Power Dissipation and Heat Sinking

Under normal operating conditions, the MAX9789/MAX9790 can dissipate a significant amount of power. The maximum power dissipation for each package is given in the *Absolute Maximum Ratings* section under Continuous Power Dissipation, or can be calculated by the following equation:

$$P_{DISSPKG(MAX)} = \frac{T_{J(MAX)} - T_A}{\theta_{JA}}$$

where $T_{J(MAX)}$ is +150°C, T_A is the ambient temperature, and θ_{JA} is the reciprocal of the derating factor in °C/W as specified in the *Absolute Maximum Ratings* section. For example, θ_{JA} for the 32-pin TQFN-EP package is +40.2°C/W for a multilayer PC board.

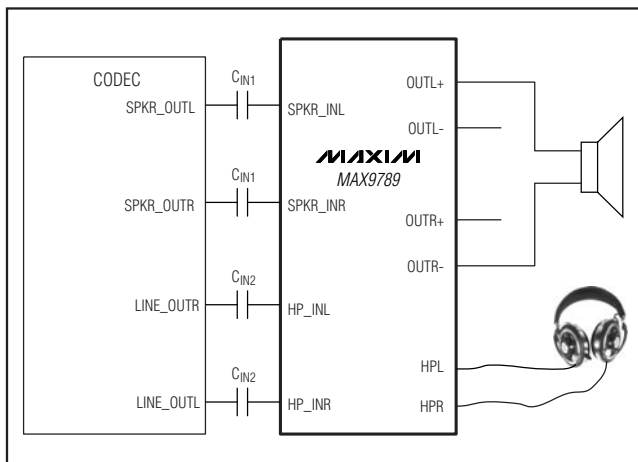

Figure 6. Mono Signal Output Configuration for MAX9789

Output Power (Speaker Amplifier)

The increase in power delivered by the BTL configuration directly results in an increase in internal power dissipation over the single-ended configuration. The maximum power dissipation for a given V_{DD} and load is given by the following equation:

$$P_{DISS(MAX)} = \frac{2V_{DD}^2}{\pi^2 R_L}$$

If the power dissipation for a given application exceeds the maximum allowed for a given package, either reduce V_{DD} , increase load impedance, decrease the ambient temperature, or add heat sinking to the device. Large output, supply, and ground PC board traces improve the maximum power dissipation in the package.

Thermal-overload protection limits total power dissipation in these devices. When the junction temperature exceeds +150°C, the thermal-protection circuitry disables the amplifier output stage. The amplifiers are enabled once the junction temperature cools by +15°C. This results in a pulsing output under continuous thermal-overload conditions as the device heats and cools.

Power Supplies

The MAX9789/MAX9790 have separate supply pins for each portion of the device, allowing for the optimum combination of headroom and power dissipation and noise immunity. The speaker amplifiers are powered from PV_{DD} . PV_{DD} ranges from 4.5V to 5.5V. The headphone amplifiers are powered from HPV_{DD} and PV_{SS} . HPV_{DD} is the positive supply of the headphone amplifiers and ranges from 3V to 5.5V. PV_{SS} is the negative supply of the headphone amplifiers. Connect PV_{SS} to CPV_{SS} . The charge pump is powered by CPV_{DD} . CPV_{DD} ranges from 3V to 5.5V and should be the same potential as HPV_{DD} . The charge pump inverts the voltage at CPV_{DD} , and the resulting voltage appears at CPV_{SS} . The internal LDO and the remainder of the device is powered by V_{DD} .

Component Selection

Supply Bypassing

The MAX9789/MAX9790 have separate supply pins for each portion of the device, allowing for the optimum combination of headroom and power dissipation and noise immunity.

Speaker Amplifier Power-Supply Input (PV_{DD})

The speaker amplifiers are powered from PV_{DD} . PV_{DD} ranges from 4.5V to 5.5V. Bypass PV_{DD} with a 0.1μF capacitor to PGND. Note additional bulk capacitance is required at the device if long input traces between PV_{DD} and the power source are used.

Windows Vista-Compliant, Stereo Class AB Speaker Amplifiers and DirectDrive Headphone Amplifiers

Headphone Amplifier Power-Supply Input (HPV_{DD} and PV_{SS})

The headphone amplifiers are powered from HPV_{DD} and PV_{SS}. HPV_{DD} is the positive supply of the headphone amplifiers and ranges from 3.0V to 5.5V. Bypass HPV_{DD} with a 10µF capacitor to PGND. PV_{SS} is the negative supply of the headphone amplifiers. Bypass PV_{SS} with a 1µF capacitor to PGND. Connect PV_{SS} to CPV_{SS}. The charge pump is powered by CPV_{DD}. CPV_{DD} ranges from 3.0V to 5.5V and should be the same potential as HPV_{DD}. Bypass CPV_{DD} with a 1µF capacitor to PGND. The charge pump inverts the voltage at CPV_{DD}, and the resulting voltage appears at CPV_{SS}. A 1µF capacitor must be connected between C1N and C1P.

Power Supply and LDO Input (V_{DD})

The internal LDO and the remainder of the device is powered by V_{DD}. V_{DD} ranges from 4.5V to 5.5V. Bypass V_{DD} with a 0.1µF capacitor to GND and two 1µF capacitors in parallel to GND. Note additional bulk capacitance is required at the device if long input traces between V_{DD} and the power source are used.

Input Filtering

The input capacitor (C_{IN}), in conjunction with the amplifier input resistance (R_{IN}), forms a highpass filter that removes the DC bias from the incoming signal. The AC-coupling capacitor allows the amplifier to bias the signal to an optimum DC level. Assuming zero source impedance, the -3dB point of the highpass filter is given by:

$$f_{-3dB} = \frac{1}{2\pi R_{IN} C_{IN}}$$

R_{IN} is the amplifier's internal input resistance value given in the *Electrical Characteristics*. Choose C_{IN} such that f_{-3dB} is well below the lowest frequency of interest. Setting f_{-3dB} too high affects the amplifier's low frequency response. Use capacitors with adequately low voltage coefficient dielectrics, such as 1206-sized X7R ceramic capacitors. Capacitors with higher voltage coefficients result in increased distortion at low frequencies (see Figure 7).

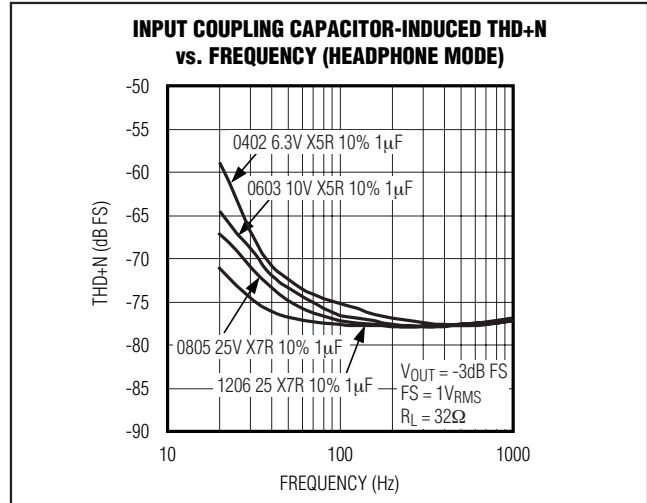

Figure 7. Input Coupling Capacitor-Induced THD+N vs. Frequency (Headphone Mode)

BIAS Capacitor

BIAS is the output of the internally generated DC bias voltage. The BIAS bypass capacitor, C_{BIAS} improves PSRR and THD+N by reducing power supply and other noise sources at the common-mode bias node, and also generates the clickless/popless, startup/shutdown DC bias waveforms for the speaker and headphone amplifiers. Bypass BIAS with a 1µF capacitor to GND.

Charge-Pump Capacitor Selection

Use capacitors with an ESR less than 100mΩ for optimum performance. Low ESR ceramic capacitors minimize the output resistance of the charge pump. For best performance over the extended temperature range, select capacitors with an X7R dielectric.

Flying Capacitor (C1)

The value of the flying capacitor (C1) affects the load regulation and output resistance of the charge pump. A C1 value that is too small degrades the device's ability to provide sufficient current drive, which leads to a loss of output voltage. Connect a 1µF capacitor between C1P and C1N.

Windows Vista-Compliant, Stereo Class AB Speaker Amplifiers and DirectDrive Headphone Amplifiers

Output Capacitor (C2)

The output capacitor value and ESR directly affect the ripple at CPV_{SS}. Increasing the value of C2 reduces output ripple. Likewise, decreasing the ESR of C2 reduces both ripple and output resistance. Lower capacitance values can be used in systems with low maximum output power levels.

CPV_{DD} Bypass Capacitor (C3)

The CPV_{DD} bypass capacitor (C3) lowers the output impedance of the power supply and reduces the impact of the MAX9789/MAX9790's charge-pump switching transients. Bypass CPV_{DD} with 1 μ F, the same value as C1, and place it physically close to the CPV_{DD} and CPGND pins.

Layout and Grounding

Proper layout and grounding are essential for optimum performance. Use large traces for the power-supply inputs and amplifier outputs to minimize losses due to parasitic trace resistance, as well as route heat away from the device. Good grounding improves audio performance, minimizes crosstalk between channels, and prevents switching noise from coupling into the audio signal. Connect PGND and GND together at a single point on the PC board. Route PGND and all traces that carry switching transients away from GND and the traces and components in the audio signal path.

Connect C2 and C3 to the PGND plane. Connect PV_{SS} and CPV_{SS} together at C2. Place the charge-pump capacitors (C1, C2, and C3) as close as possible to the device. Bypass PV_{DD} with a 0.1 μ F capacitor to PGND. Place the bypass capacitors as close as possible to the device.

Use large, low-resistance output traces. As load impedance decreases, the current drawn from the device outputs increase. At higher current, the resistance of the output traces decrease the power delivered to the load. For example, if 2W is delivered from the speaker output to a 4 Ω load through a 100m Ω trace, 49mW is consumed in the trace. If power is delivered through a 10m Ω trace, only 5mW is consumed in the trace. Large output, supply and GND traces also improve the power dissipation of the device.

The MAX9789/MAX9790 thin QFN package features an exposed thermal pad on its underside. This pad lowers the package's thermal resistance by providing a direct heat conduction path from the die to the printed circuit board. Connect the exposed thermal pad to GND by using a large pad and multiple vias to the GND plane.

Windows Vista-Compliant, Stereo Class AB Speaker Amplifiers and DirectDrive Headphone Amplifiers

Block Diagrams

MAX9789/MAX9790

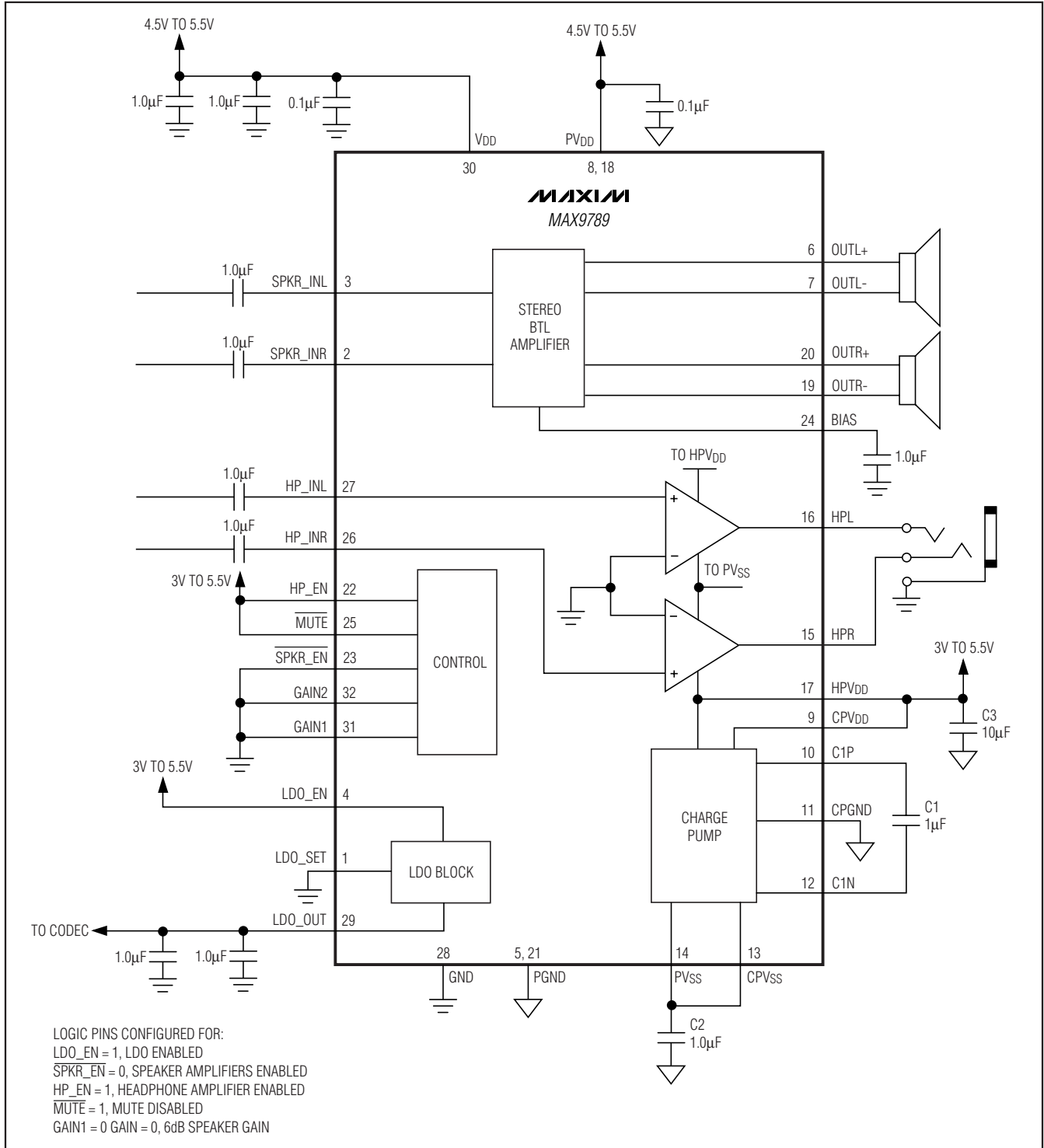

Windows Vista-Compliant, Stereo Class AB Speaker Amplifiers and DirectDrive Headphone Amplifiers

Block Diagrams (continued)

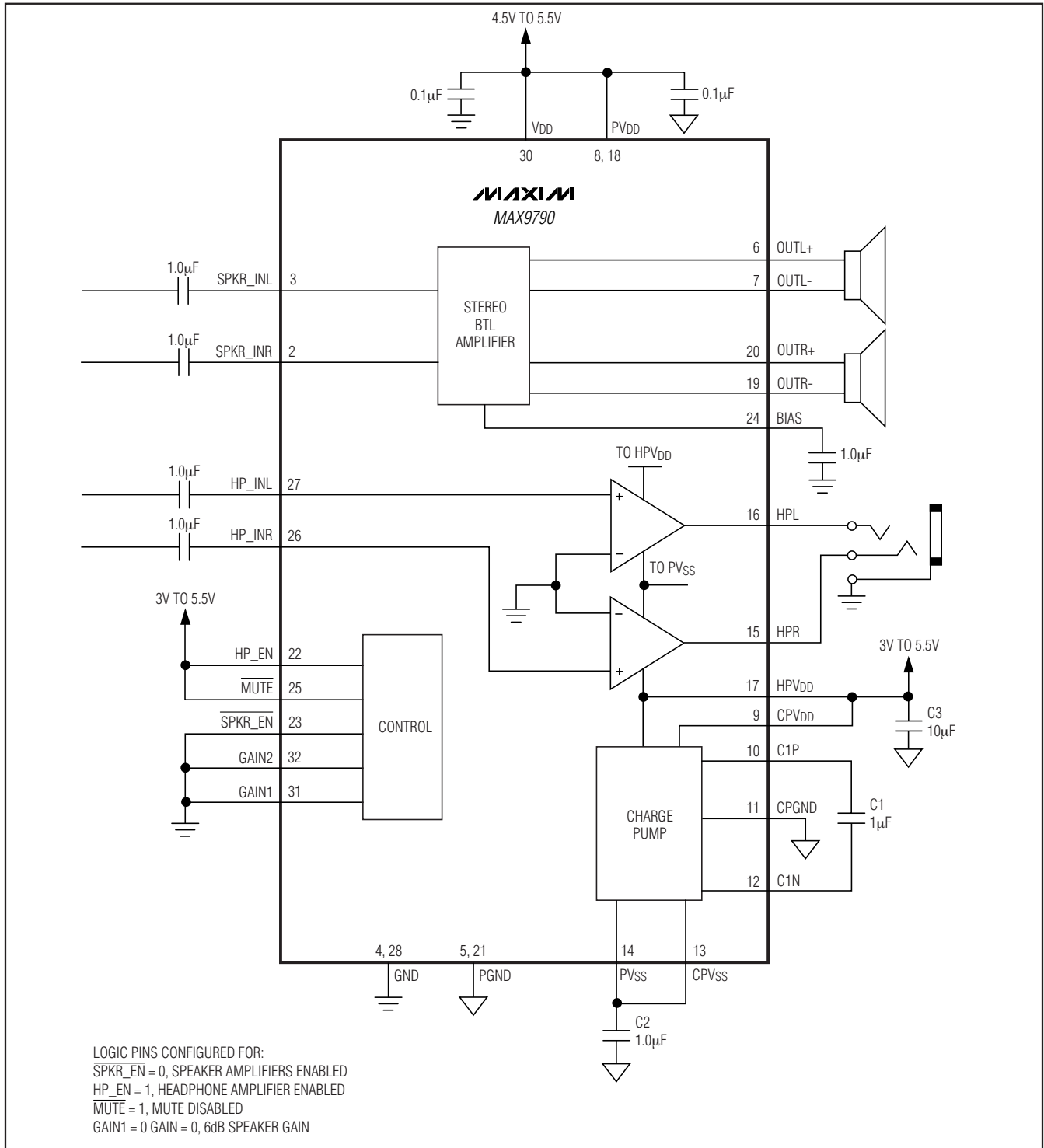

Windows Vista-Compliant, Stereo Class AB Speaker Amplifiers and DirectDrive Headphone Amplifiers

System Diagrams

MAX9789/MAX9790

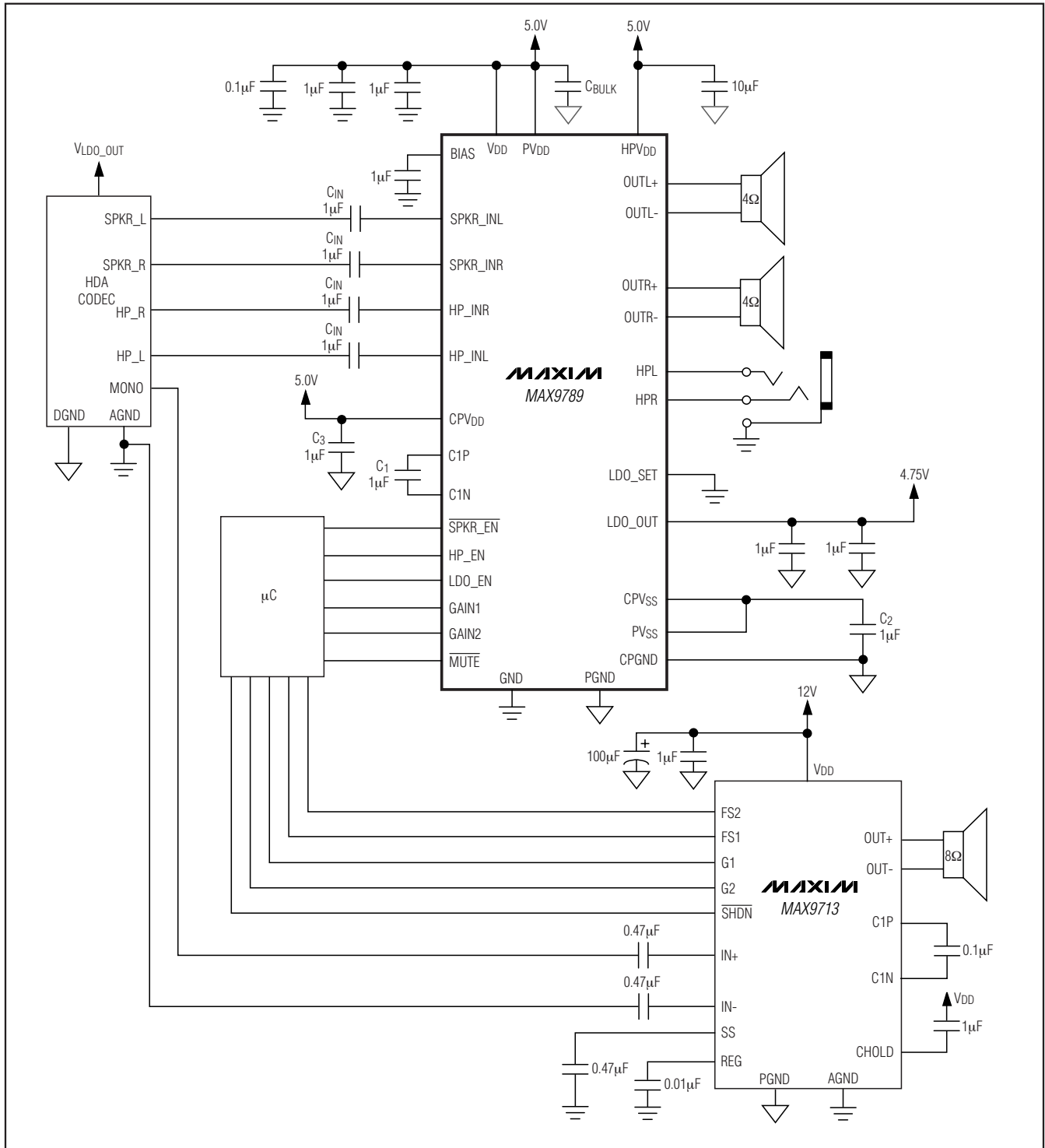

Windows Vista-Compliant, Stereo Class AB Speaker Amplifiers and DirectDrive Headphone Amplifiers

System Diagrams (continued)

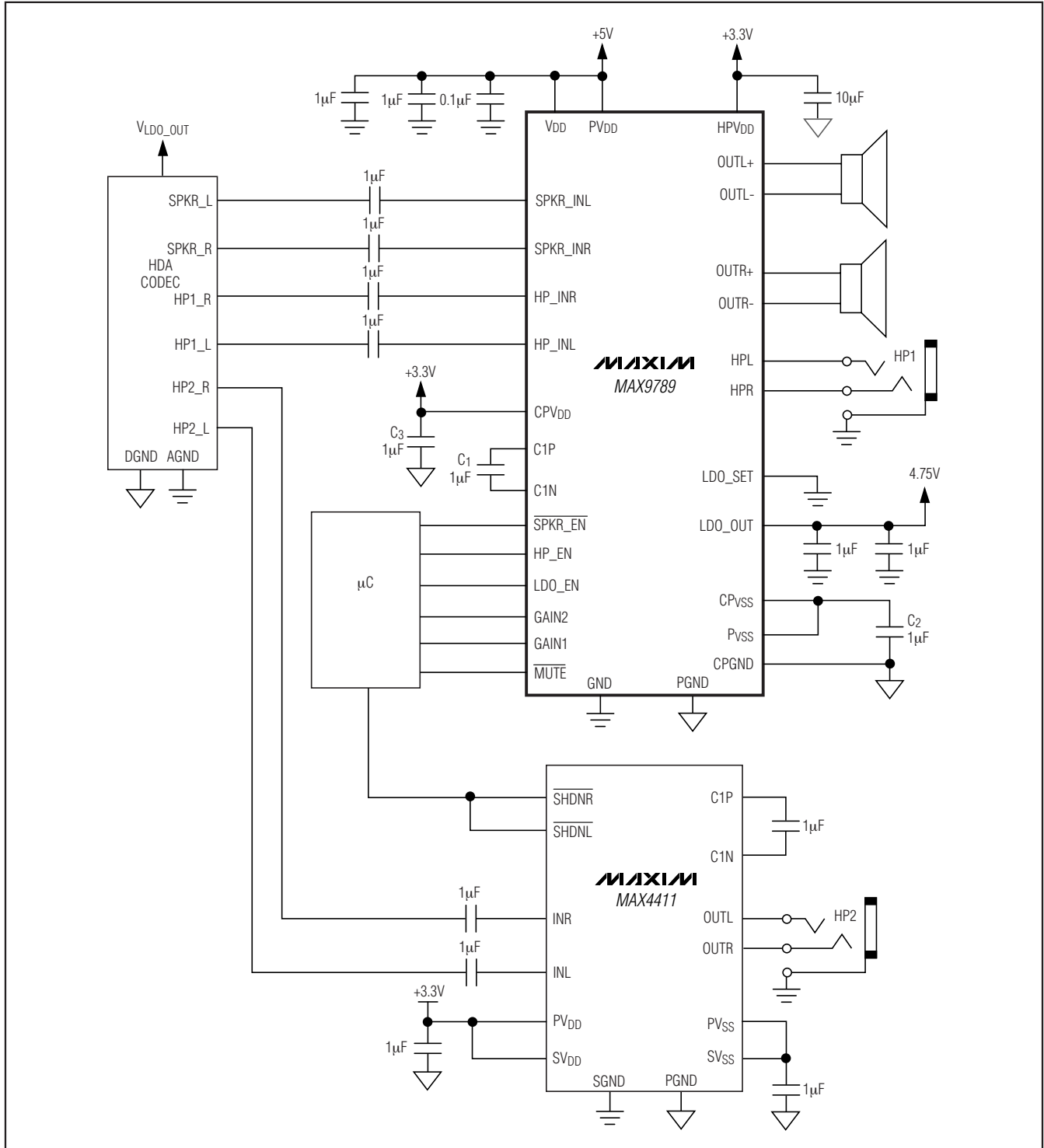

Windows Vista-Compliant, Stereo Class AB Speaker Amplifiers and DirectDrive Headphone Amplifiers

Pin Configurations

MAX9789/MAX9790

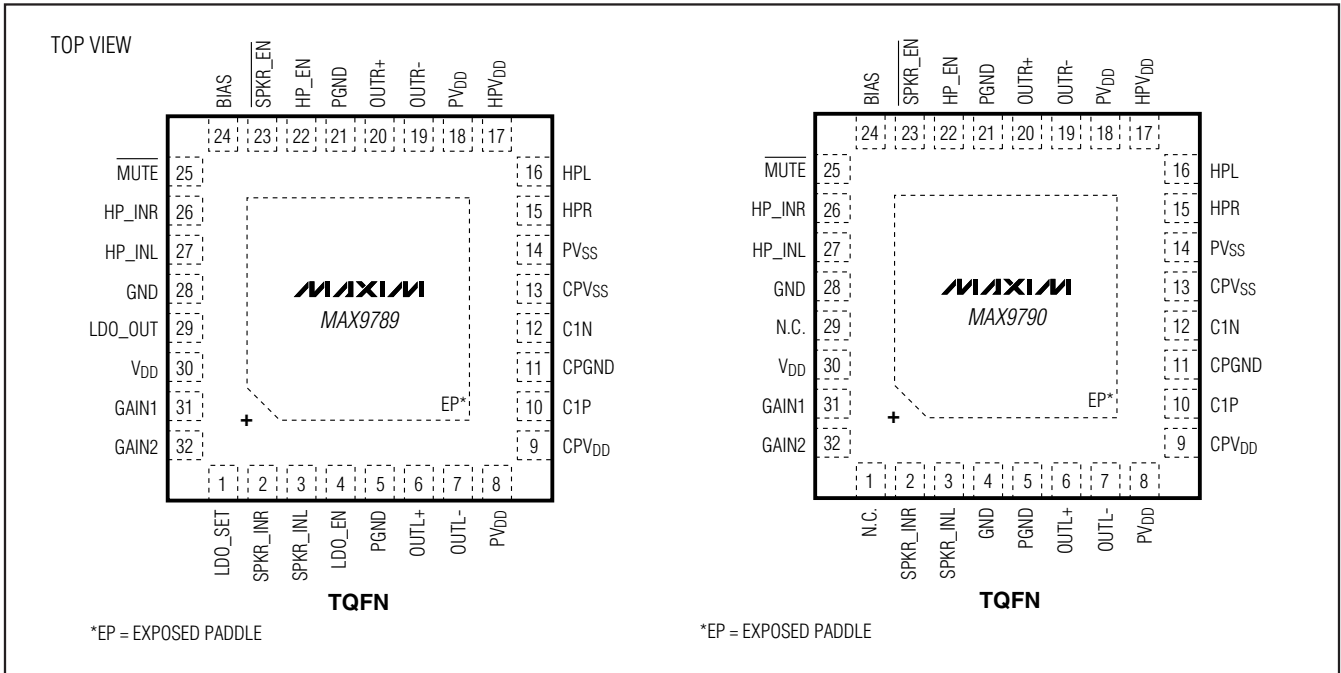

Simplified Block Diagrams (continued)

Chip Information

PROCESS: BiCMOS

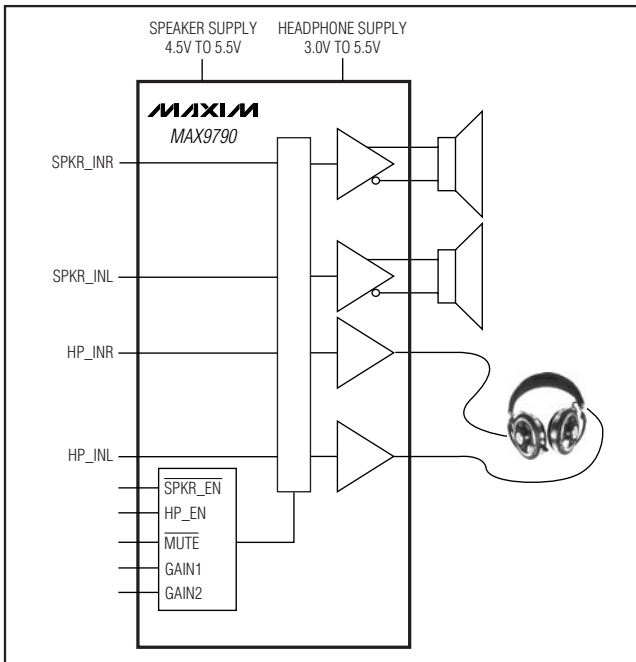

Windows Vista-Compliant, Stereo Class AB Speaker Amplifiers and DirectDrive Headphone Amplifiers

Package Information

For the latest package outline information and land patterns, go to www.maxim-ic.com/packages. Note that a "+", "#", or "-" in the package code indicates RoHS status only. Package drawings may show a different suffix character, but the drawing pertains to the package regardless of RoHS status.

PACKAGE TYPE	PACKAGE CODE	DOCUMENT NO.
32 TQFN-EP	T3255N-1	21-0140

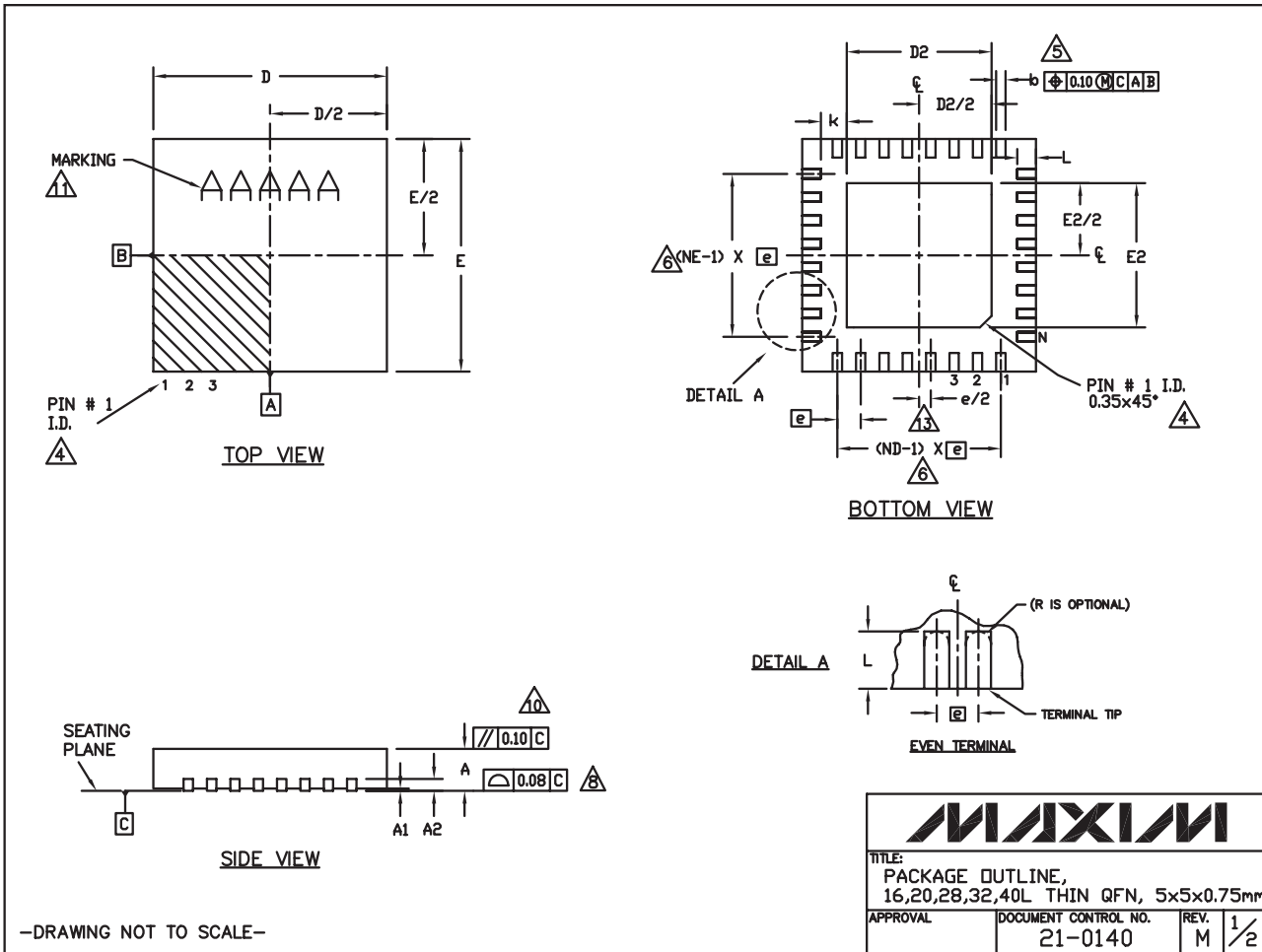

Windows Vista-Compliant, Stereo Class AB Speaker Amplifiers and DirectDrive Headphone Amplifiers

Package Information (continued)

For the latest package outline information and land patterns, go to www.maxim-ic.com/packages. Note that a "+", "#", or "-" in the package code indicates RoHS status only. Package drawings may show a different suffix character, but the drawing pertains to the package regardless of RoHS status.

MAX9789/MAX9790

COMMON DIMENSIONS															
PKG.	16L 5x5			20L 5x5			28L 5x5			32L 5x5			40L 5x5		
SYMBOL	MIN.	NDM.	MAX.	MIN.	NDM.	MAX.	MIN.	NDM.	MAX.	MIN.	NDM.	MAX.	MIN.	NDM.	MAX.
A	0.70	0.75	0.80	0.70	0.75	0.80	0.70	0.75	0.80	0.70	0.75	0.80	0.70	0.75	0.80
A1	0	0.02	0.05	0	0.02	0.05	0	0.02	0.05	0	0.02	0.05	0	0.02	0.05
A2	0.20 REF.			0.20 REF.			0.20 REF.			0.20 REF.			0.20 REF.		
b	0.25	0.30	0.35	0.25	0.30	0.35	0.20	0.25	0.30	0.20	0.25	0.30	0.15	0.20	0.25
D	4.90	5.00	5.10	4.90	5.00	5.10	4.90	5.00	5.10	4.90	5.00	5.10	4.90	5.00	5.10
E	4.90	5.00	5.10	4.90	5.00	5.10	4.90	5.00	5.10	4.90	5.00	5.10	4.90	5.00	5.10
e	0.80 BSC.			0.65 BSC.			0.50 BSC.			0.50 BSC.			0.40 BSC.		
k	0.25	-	-	0.25	-	-	0.25	-	-	0.25	-	-	0.25	-	-
L	0.30	0.40	0.50	0.45	0.55	0.65	0.45	0.55	0.65	0.30	0.40	0.50	0.30	0.40	0.50
N	16			20			28			32			40		
ND	4			5			7			8			10		
NE	4			5			7			8			10		
JEDEC	VHHB			VHHC			VHHD-1			VHHD-2			-----		

NOTES:

- DIMENSIONING & TOLERANCING CONFORM TO ASME Y14.5M-1994.
- ALL DIMENSIONS ARE IN MILLIMETERS. ANGLES ARE IN DEGREES.
- N IS THE TOTAL NUMBER OF TERMINALS.
- THE TERMINAL #1 IDENTIFIER AND TERMINAL NUMBERING CONVENTION SHALL CONFORM TO JESD 95-1 SPP-012. DETAILS OF TERMINAL #1 IDENTIFIER ARE OPTIONAL, BUT MUST BE LOCATED WITHIN THE ZONE INDICATED. THE TERMINAL #1 IDENTIFIER MAY BE EITHER A MOLD OR MARKED FEATURE.
- DIMENSION b APPLIES TO METALLIZED TERMINAL AND IS MEASURED BETWEEN 0.25 mm AND 0.30 mm FROM TERMINAL TIP.
- ND AND NE REFER TO THE NUMBER OF TERMINALS ON EACH D AND E SIDE RESPECTIVELY.
- DEPOPULATION IS POSSIBLE IN A SYMMETRICAL FASHION.
- COPLANARITY APPLIES TO THE EXPOSED HEAT SINK SLUG AS WELL AS THE TERMINALS.
- DRAWING CONFORMS TO JEDEC MO220, EXCEPT EXPOSED PAD DIMENSION FOR T2855-3, T2855-6, T4055-1 AND T4055-2.
- WARPAGE SHALL NOT EXCEED 0.10 mm.
- MARKING IS FOR PACKAGE ORIENTATION REFERENCE ONLY.
- NUMBER OF LEADS SHOWN ARE FOR REFERENCE ONLY.
- LEAD CENTERLINES TO BE AT TRUE POSITION AS DEFINED BY BASIC DIMENSION 'e', ±0.05.
- ALL DIMENSIONS APPLY TO BOTH LEADED (-) AND PbFREE (+) PKG. CODES.

-DRAWING NOT TO SCALE-

EXPOSED PAD VARIATIONS						
PKG. CODES	D2			E2		
	MIN.	NDM.	MAX.	MIN.	NDM.	MAX.
T1655-2	3.00	3.10	3.20	3.00	3.10	3.20
T1655-3	3.00	3.10	3.20	3.00	3.10	3.20
T1655-4	2.19	2.29	2.39	2.19	2.29	2.39
T165N-1	3.00	3.10	3.20	3.00	3.10	3.20
T2055-3	3.00	3.10	3.20	3.00	3.10	3.20
T2055-4	3.00	3.10	3.20	3.00	3.10	3.20
T2055-5	3.15	3.25	3.35	3.15	3.25	3.35
T2055MN-5	3.15	3.25	3.35	3.15	3.25	3.35
T2855-3	3.15	3.25	3.35	3.15	3.25	3.35
T2855-4	2.60	2.70	2.80	2.60	2.70	2.80
T2855-5	2.60	2.70	2.80	2.60	2.70	2.80
T2855-6	3.15	3.25	3.35	3.15	3.25	3.35
T2855-7	2.60	2.70	2.80	2.60	2.70	2.80
T2855-8	3.15	3.25	3.35	3.15	3.25	3.35
T2855N-1	3.15	3.25	3.35	3.15	3.25	3.35
T3255-3	3.00	3.10	3.20	3.00	3.10	3.20
T3255-4	3.00	3.10	3.20	3.00	3.10	3.20
T3255M-4	3.00	3.10	3.20	3.00	3.10	3.20
T3255-5	3.00	3.10	3.20	3.00	3.10	3.20
T3255N-1	3.00	3.10	3.20	3.00	3.10	3.20
T4055-1	3.40	3.50	3.60	3.40	3.50	3.60
T4055-2	3.40	3.50	3.60	3.40	3.50	3.60
T4055N-1	3.40	3.50	3.60	3.40	3.50	3.60
T4055MN-1	3.40	3.50	3.60	3.40	3.50	3.60



TITLE:
PACKAGE OUTLINE,
16,20,28,32,40L THIN QFN, 5x5x0.75mm

APPROVAL	DOCUMENT CONTROL NO. 21-0140	REV. M	2/2
----------	---------------------------------	--------	-----

Windows Vista-Compliant, Stereo Class AB Speaker Amplifiers and DirectDrive Headphone Amplifiers

Revision History

REVISION NUMBER	REVISION DATE	DESCRIPTION	PAGES CHANGED
2	8/08	Added MAX9789C to data sheet and made miscellaneous clarifications	1–11, 13, 14, 18
3	9/09	Corrected the <i>Block Diagrams</i>	21

Maxim cannot assume responsibility for use of any circuitry other than circuitry entirely embodied in a Maxim product. No circuit patent licenses are implied. Maxim reserves the right to change the circuitry and specifications without notice at any time.

28 **Maxim Integrated Products, 120 San Gabriel Drive, Sunnyvale, CA 94086 408-737-7600**

© 2009 Maxim Integrated Products

Maxim is a registered trademark of Maxim Integrated Products, Inc.