



# Dual ECL and Dual/Quad PECL, 500ps, Ultra-High-Speed Comparators

## General Description

The MAX9600/MAX9601/MAX9602 ultra-high-speed comparators feature extremely low propagation delay (500ps). These dual and quad comparators minimize propagation delay skew (10ps) and are designed for low propagation delay dispersion (30ps). These features make them ideal for applications where high-fidelity tracking of narrow pulses and low timing dispersion is critical.

The differential input stage accepts a wide range of signals in the common-mode range from  $(V_{EE} + 3V)$  to  $(V_{CC} - 2V)$ . The outputs are complementary digital signals, compatible with ECL and PECL systems, and provide sufficient current to directly drive transmission lines terminated in  $50\Omega$ .

The MAX9600/MAX9601 dual-channel ECL and dual-channel PECL output comparators incorporate latch enable ( $LE_{-}$ ,  $\overline{LE}_{-}$ ), and hysteresis ( $HYS_{-}$ ). The complementary latch-enable control permits tracking, track-hold, or sample-hold mode of operations. The latch enables can be driven with standard ECL logic for MAX9600 and PECL logic for MAX9601. The MAX9602 quad-channel PECL output comparator is ideal for high-density packaging in limited board space.

The MAX9600/MAX9601 are available in 20-pin TSSOP packages, and the MAX9602 is offered in a 24-pin TSSOP package. The MAX9600/MAX9601/MAX9602 are specified for operation from  $-40^{\circ}\text{C}$  to  $+85^{\circ}\text{C}$ .

## Applications

VLSI and High-Speed Memory ATE  
 High-Speed Instrumentation  
 Scope/Logic Analyzer Front Ends  
 High-Speed Triggering  
 Threshold and Peak Detection  
 Line Receiving/Signal Restoration

## Features

- ◆ 500ps Propagation Delay
- ◆ 30ps Propagation Delay Dispersion
- ◆ 4Gbps Tracking Frequency
- ◆ -2.2V to +3V Input Range with +5V/-5.2V Supplies
- ◆ -1.2V to +4V Input Range with +6V/-4.2V Supplies
- ◆ Differential ECL Outputs (MAX9600)
- ◆ Differential PECL Outputs (MAX9601/MAX9602)
- ◆ Latch Enable (MAX9600/MAX9601)
- ◆ Adjustable Hysteresis (MAX9600/MAX9601)

## Ordering Information

PART	TEMP RANGE	PIN-PACKAGE
MAX9600EUP	$-40^{\circ}\text{C}$ to $+85^{\circ}\text{C}$	20 TSSOP
MAX9601EUP	$-40^{\circ}\text{C}$ to $+85^{\circ}\text{C}$	20 TSSOP
MAX9602EUG	$-40^{\circ}\text{C}$ to $+85^{\circ}\text{C}$	24 TSSOP

## Selector Guide

PART	PIN-PACKAGE	SELECTION
MAX9600EUP	20 TSSOP	Dual ECL Output Comparator with Latch Enable and Hysteresis
MAX9601EUP	20 TSSOP	Dual PECL Output Comparator with Latch Enable and Hysteresis
MAX9602EUG	24 TSSOP	Quad PECL Output Comparator

Pin Configurations appear at end of data sheet.

## Functional Diagrams

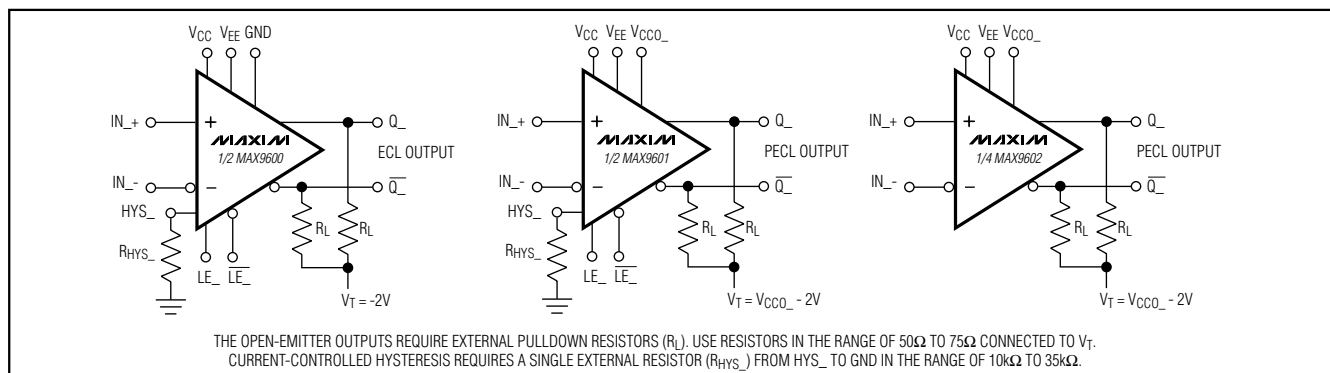

For pricing, delivery, and ordering information, please contact Maxim/Dallas Direct! at 1-888-629-4642, or visit Maxim's website at [www.maxim-ic.com](http://www.maxim-ic.com).

# Dual ECL and Dual/Quad PECL, 500ps, Ultra-High-Speed Comparators

## ABSOLUTE MAXIMUM RATINGS

$V_S = V_{CC} - V_{EE}$ .....	12.0V	Input Current to Any Input Pin.....	10mA
$V_{CC}$ to GND (MAX9600) .....	6.8V	HYS_ Current (MAX9600/MAX9601) .....	-1mA
$V_{EE}$ to GND (MAX9600) .....	-6.5V	Continuous Output Current.....	50mA
Differential Input Voltage .....	$\pm 6.5V$	Continuous Power Dissipation ( $T_A = +70^\circ C$ )	
Latch Differential Voltage .....	$\pm 4V$	20-Pin TSSOP (derate 10.9mW/ $^\circ C$ above $+70^\circ C$ ) .....	879mW
Common-Mode Input Voltage ( $V_{CM}$ ) .....	$V_{EE}$ to $V_{CC}$	24-Pin TSSOP (derate 12.2mW/ $^\circ C$ above $+70^\circ C$ ) .....	975mW
$V_{CCO\_}$ to $V_{EE}$		Operating Temperature Range .....	$-40^\circ C$ to $+85^\circ C$
(MAX9601/MAX9602).....	( $V_{EE} - 0.3V$ ) to ( $V_{CC} + 0.3V$ )	Junction Temperature .....	$+150^\circ C$
$LE\_ , \overline{LE\_}$ to GND		Storage Temperature Range .....	$-65^\circ C$ to $+150^\circ C$
MAX9600 .....	( $V_{EE} - 0.3V$ ) to $0.3V$	Lead Temperature (soldering, 10s) .....	$+300^\circ C$
MAX9601 .....	( $V_{EE} - 0.3V$ ) to ( $V_{CCO\_} + 0.3V$ )		

Stresses beyond those listed under "Absolute Maximum Ratings" may cause permanent damage to the device. These are stress ratings only, and functional operation of the device at these or any other conditions beyond those indicated in the operational sections of the specifications is not implied. Exposure to absolute maximum rating conditions for extended periods may affect device reliability.

## DC ELECTRICAL CHARACTERISTICS

( $V_{CC} = 5V$ ,  $V_{EE} = -5.2V$ ,  $V_{CM} = 0V$ , HYS\_ = open (MAX9600/MAX9601),  $LE\_ = low$ ,  $\overline{LE\_} = high$  (MAX9600/MAX9601), GND = 0V,  $R_L = 50\Omega$  to  $-2V$  (MAX9600),  $V_{CCO\_} = 5V$ ,  $R_L = 50\Omega$  to  $3V$  (MAX9601/MAX9602),  $T_A = T_{MIN}$  to  $T_{MAX}$ . Typical values are at  $T_A = +25^\circ C$ , unless otherwise noted.) (Note 1)

PARAMETER	SYMBOL	CONDITIONS	MIN	TYP	MAX	UNITS
<b>INPUT (IN_+, IN_-)</b>						
Input Differential Voltage Range	$V_{ID}$	Guaranteed by input bias current tests	-5.2		+5.2	V
Input Common-Mode Voltage	$V_{CM}$	Guaranteed by input bias current tests	$V_{EE} + 3$		$V_{CC} - 2$	V
Input Offset Voltage	$V_{OS}$	$T_A = +25^\circ C$		$\pm 1$	$\pm 5$	mV
		$T_{MIN} \leq T_A \leq T_{MAX}$			$\pm 9$	
Input Offset-Voltage Tempco	$TCV_{OS}$			8		$\mu V/^\circ C$
Input Offset-Voltage Channel Matching				1		mV
Input Bias Current	$I_B$	$V_{ID} = \pm 5.2V$		6	20	$\mu A$
Input Bias-Current Tempco	$TCI_B$			10		$nA/^\circ C$
Input Offset Current	$I_{OS}$			0.3	$\pm 5$	$\mu A$
Input Resistance	$R_{IN}$	Differential mode ( $V_{ID} \leq 10mV$ )		10		$k\Omega$
		Common mode ( $(V_{EE} + 3V) \leq V_{CM} \leq (V_{CC} - 2V)$ )		100		$M\Omega$
<b>LATCH INPUT (<math>LE\_ , \overline{LE\_}</math>)</b>						
Latch Differential Input Voltage	$V_{LD}$	Guaranteed by latch input current	MAX9600	0.4	2.0	V
			MAX9601	0.25	3.50	
Latch Input Voltage Range	$V_{LR}$	MAX9600	-2	0	V	
		MAX9601	$V_{CCO\_} \geq 3.5V$	$V_{CCO\_} - 3.5$		$V_{CCO\_}$
			$V_{CCO\_} < 3.5V$	0		$V_{CCO\_}$
Latch Input Current	$I_{LE\_}, I_{\overline{LE\_}}$	MAX9600		5	20	$\mu A$
		MAX9601		5	20	
<b>HYSTERESIS INPUT (HYS_)</b>						
Input-Referred Hysteresis		MAX9600/MAX9601	$R_{HYS} = \infty$	0		mV
			$R_{HYS} = 16.4k\Omega$	30		

# Dual ECL and Dual/Quad PECL, 500ps, Ultra-High-Speed Comparators

MAX9600/MAX9601/MAX9602

## DC ELECTRICAL CHARACTERISTICS (continued)

( $V_{CC} = 5V$ ,  $V_{EE} = -5.2V$ ,  $V_{CM} = 0V$ ,  $HYS_{-} = \text{open}$  (MAX9600/MAX9601),  $LE_{-} = \text{low}$ ,  $\overline{LE}_{-} = \text{high}$  (MAX9600/MAX9601),  $GND = 0V$ ,  $R_L = 50\Omega$  to  $-2V$  (MAX9600),  $V_{CCO_{-}} = 5V$ ,  $R_L = 50\Omega$  to  $3V$  (MAX9601/MAX9602),  $T_A = T_{MIN}$  to  $T_{MAX}$ . Typical values are at  $T_A = +25^{\circ}C$ , unless otherwise noted.) (Note 1)

PARAMETER	SYMBOL	CONDITIONS		MIN	TYP	MAX	UNITS
<b>OUTPUT (<math>Q_{-}</math>, <math>\overline{Q}_{-}</math>)</b>							
Logic Output High Voltage	$V_{OH}$	$T_A = +25^{\circ}C$	MAX9600	-1.10	-0.94	-0.75	V
			MAX9601/MAX9602	$V_{CCO_{-}}$ - 1.10	$V_{CCO_{-}}$ - 0.94	$V_{CCO_{-}}$ - 0.75	
		$T_A = T_{MIN}$	MAX9600	-1.2	-1.02	-0.8	
			MAX9601/MAX9602	$V_{CCO_{-}}$ - 1.2	$V_{CCO_{-}}$ - 1.02	$V_{CCO_{-}}$ - 0.8	
		$T_A = T_{MAX}$	MAX9600	-1.05	-0.87	-0.70	
			MAX9601/MAX9602	$V_{CCO_{-}}$ - 1.05	$V_{CCO_{-}}$ - 0.87	$V_{CCO_{-}}$ - 0.70	
Logic Output Low Voltage	$V_{OL}$	$T_A = +25^{\circ}C$	MAX9600	-1.95	-1.72	-1.55	V
			MAX9601/MAX9602	$V_{CCO_{-}}$ - 1.95	$V_{CCO_{-}}$ - 1.72	$V_{CCO_{-}}$ - 1.55	
		$T_A = T_{MIN}$	MAX9600	-2.0	-1.78	-1.6	
			MAX9601/MAX9602	$V_{CCO_{-}}$ - 2.0	$V_{CCO_{-}}$ - 1.78	$V_{CCO_{-}}$ - 1.6	
		$T_A = T_{MAX}$	MAX9600	-1.9	-1.66	-1.50	
			MAX9601/MAX9602	$V_{CCO_{-}}$ - 1.9	$V_{CCO_{-}}$ - 1.66	$V_{CCO_{-}}$ - 1.5	
<b>SUPPLY</b>							
Positive Supply Voltage	$V_{CC}$	Guaranteed by output swing tests		4.3	5	6.3	V
Negative Supply Voltage	$V_{EE}$	Guaranteed by output swing tests		-6	-5.2	-4	V
Supply Voltage Difference	$V_S$	$V_S = (V_{CC} - V_{EE})$ , guaranteed by output swing tests		9.5		11.5	V
Logic Supply Voltage	$V_{CCO_{-}}$	MAX9601/MAX9602		2.4		$V_{CC}$	V
Positive Supply Current	$I_{CC}$	(Note 2)	MAX9600		16	24	mA
			MAX9601		19	27	
			MAX9602		28	39	
Negative Supply Current	$I_{EE}$	(Note 2)	MAX9600		21	28	mA
			MAX9601		24	33	
			MAX9602		38	49	
Power-Supply Dissipation	$P_{DISS}$	(Note 2)	MAX9600		190	266	mW
			MAX9601		220	307	
			MAX9602		338	450	
Common-Mode Rejection Ratio	CMRR	$(V_{EE} + 3V) \leq V_{CM} \leq (V_{CC} - 2V)$			70		dB
Power-Supply Rejection Ratio	PSRR	$4.3V \leq V_{CC} \leq 6.3V$ , $-6V \leq V_{EE} \leq -4V$ , $9.5V \leq V_S \leq 11.5V$			65		dB

# Dual ECL and Dual/Quad PECL, 500ps, Ultra-High-Speed Comparators

## AC ELECTRICAL CHARACTERISTICS

( $V_{CC} = 5V$ ,  $V_{EE} = -5.2V$ ,  $V_{CM} = 0V$ ,  $HYS_- = \text{open}$  (MAX9600/MAX9601),  $LE_- = \text{low}$ ,  $\overline{LE}_- = \text{high}$  (MAX9600/MAX9601),  $C_L = 5pF$ ,  $GND = 0V$ ,  $R_L = 50\Omega$  to  $-2V$  (MAX9600),  $V_{CCO_-} = 5V$ ,  $R_L = 50\Omega$  to  $3V$  (MAX9601/MAX9602),  $T_A = T_{MIN}$  to  $T_{MAX}$ . Typical values are at  $T_A = +25^\circ C$ , unless otherwise noted.) (Note 1)

PARAMETER	SYMBOL	CONDITIONS	MIN	TYP	MAX	UNITS
Tracking Frequency Toggle Rate	$f_{MAX}$	$V_{OUT} = 550mV_{P-P}$ , input overdrive = 100mV		4		Gbps
Minimum Pulse Width	$t_{PW}$	$V_{OUT} = 550mV_{P-P}$ , input overdrive = 100mV		250		ps
Propagation Delay	$t_{PD-}$ , $t_{PD+}$	Input overdrive = 100mV, Figure 1, (Note 3)		500	700	ps
Propagation Delay Tempco	$TCt_{PD}$			0.5		ps/ $^\circ C$
Propagation Delay Skew	$t_{PDSKEW}$	Input overdrive = 100mV (Note 4)		10		ps
Propagation Delay Match		Input overdrive = 100mV (Note 5)		40		ps
Propagation Delay Dispersion Overdrive		10mV to 100mV		15		ps
		100mV to 2V		40		
Propagation Delay Dispersion Common-Mode Voltage		$(V_{EE} + 3V) \leq V_{CM} \leq (V_{CC} - 2V)$		10		ps
Propagation Delay Dispersion Input Slew Rate	$V_{IN} = 1V_{P-P}$ input overdrive = 100mV	0.2V/ns to 10V/ns		40		
Propagation Delay Dispersion Duty Cycle		10% to 90% at 250MHz		30		
Propagation Delay Dispersion Pulse Width		350ps to 1ns		20		
Unit-to-Unit Propagation Delay Match			Input overdrive = 100mV		50	
Output Jitter		$V_{IN} = 2V_{P-P}$ ; 50MHz		300		fs
Input Capacitance	$C_{IN}$	$IN_+$ or $IN_-$ , with respect to GND		2		pF
Latch Setup Time	$t_{LS}$	Figure 1, (Notes 3, 6)	250	80		ps
Latch Hold Time	$t_{LH}$	Figure 1, (Notes 3, 6)	300	85		ps
Minimum Pulse Width	$t_{LPW}$	Figure 1		250		ps
Latch to Output Delay	$t_{LPD}$	Figure 1		200		ps
Rise Time and Fall Time	$t_R$ , $t_F$	20% to 80%, Figure 1		200		ps

**Note 1:** All devices are 100% production tested at  $T_A = +25^\circ C$ . Specifications over temperature are guaranteed by design.

**Note 2:** Does not include output state current in  $Q_-$ ,  $\overline{Q}_-$ .

**Note 3:** Guaranteed by design.

**Note 4:** Propagation delay skew ( $t_{PDSKEW}$ ) is for a single channel and is the difference between the propagation delay to the high-to-low output transition vs. the low-to-high output transition.

**Note 5:** Propagation delay match is the difference of  $t_{PD-}$  or  $t_{PD+}$  of one channel to the  $t_{PD-}$  or  $t_{PD+}$  of another channel of the same device.

**Note 6:** Latch setup and hold-timing specifications are for a differentially driven latch signal.

# Dual ECL and Dual/Quad PECL, 500ps, Ultra-High-Speed Comparators

## Typical Operating Characteristics

( $V_{CC} = 5V$ ,  $V_{EE} = -5.2V$ ,  $V_{CM} = 0V$ ,  $HYS_{-}$  = open (MAX9600/MAX9601),  $LE_{-}$  = low,  $\overline{LE}_{-}$  = high (MAX9600/MAX9601),  $C_L = 5pF$ ,  $GND = 0V$ ,  $R_L = 50\Omega$  to  $-2V$  (MAX9600),  $V_{CCO_{-}} = 5V$ ,  $R_L = 50\Omega$  to  $3V$  (MAX9601/MAX9602), input slew rate =  $2V/ns$ , duty cycle = 50%,  $T_A = T_{MIN}$  to  $T_{MAX}$ . Typical values are at  $T_A = +25^{\circ}C$ , unless otherwise noted.) (Note 1)

MAX9600/MAX9601/MAX9602

**PROPAGATION DELAY vs. INPUT OVERDRIVE**  
( $V_{CC} = 10mV$  TO  $100mV$ )

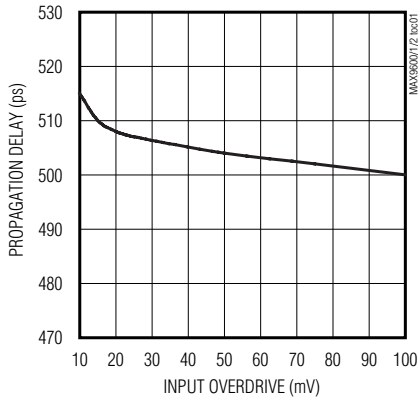

**PROPAGATION DELAY vs. INPUT OVERDRIVE**  
( $V_{OD} = 0.1V$  TO  $2V$ )

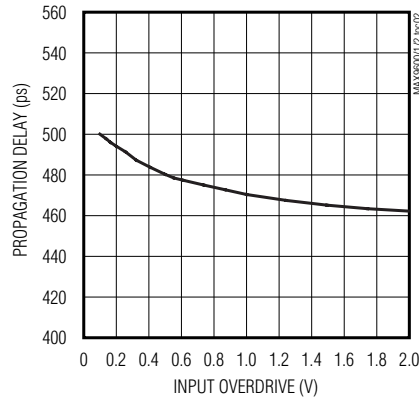

**PROPAGATION DELAY vs. SOURCE IMPEDANCE**

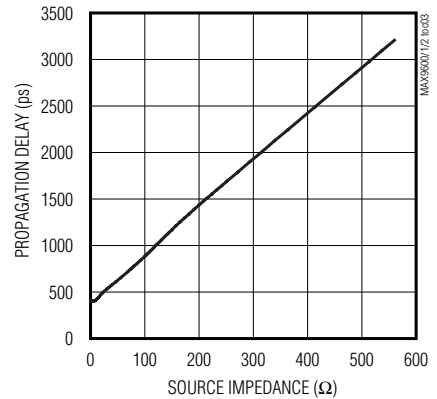

**PROPAGATION DELAY vs. CAPACITIVE LOAD**

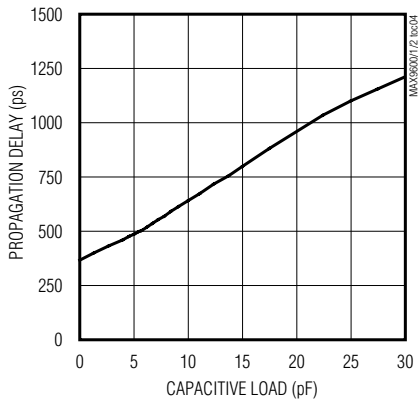

**PROPAGATION DELAY vs. TEMPERATURE**

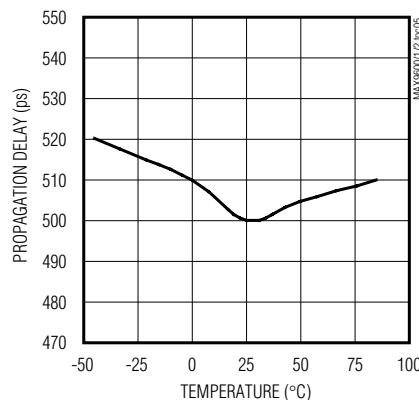

**PROPAGATION DELAY vs. COMMON-MODE VOLTAGE**

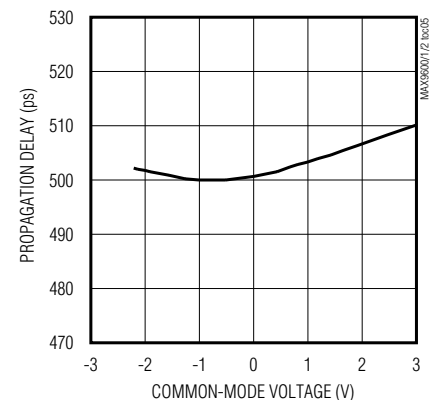

# Dual ECL and Dual/Quad PECL, 500ps, Ultra-High-Speed Comparators

## Typical Operating Characteristics (continued)

( $V_{CC} = 5V$ ,  $V_{EE} = -5.2V$ ,  $V_{CM} = 0V$ ,  $HYS_{-} = \text{open}$  (MAX9600/MAX9601),  $LE_{-} = \text{low}$ ,  $\overline{LE}_{-} = \text{high}$  (MAX9600/MAX9601),  $C_L = 5pF$ ,  $GND = 0V$ ,  $R_L = 50\Omega$  to  $-2V$  (MAX9600),  $V_{CCO_{-}} = 5V$ ,  $R_L = 50\Omega$  to  $3V$  (MAX9601/MAX9602), input slew rate =  $2V/ns$ , duty cycle = 50%,  $T_A = T_{MIN}$  to  $T_{MAX}$ . Typical values are at  $T_A = +25^{\circ}C$ , unless otherwise noted.) (Note 1)

**PROPAGATION DELAY vs. PULSE WIDTH**

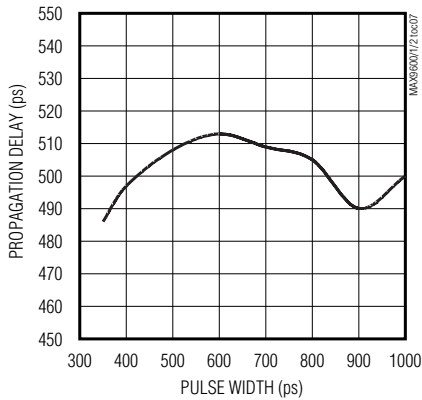

**PROPAGATION DELAY vs. INPUT SLEW RATE**

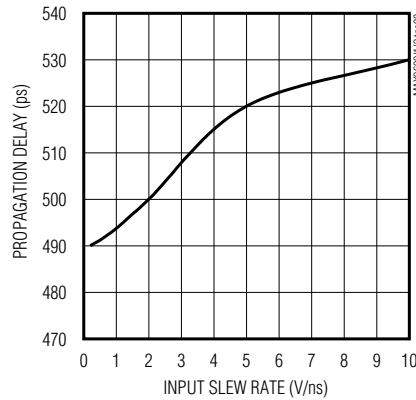

**PROPAGATION DELAY vs. DUTY CYCLE**

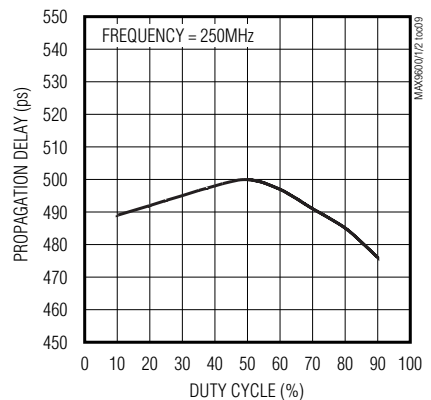

**INPUT OFFSET VOLTAGE vs. TEMPERATURE**

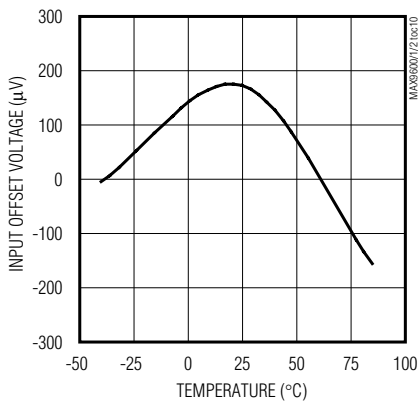

**HYSTERESIS vs. R<sub>HYS</sub> TO GND**

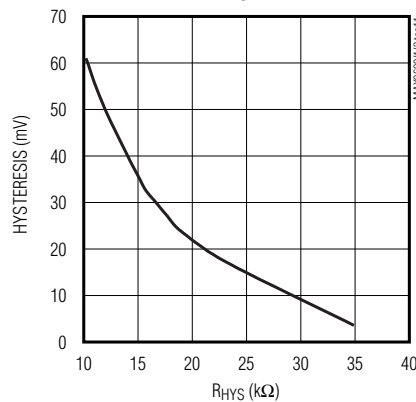

**HYSTERESIS vs. TEMPERATURE**

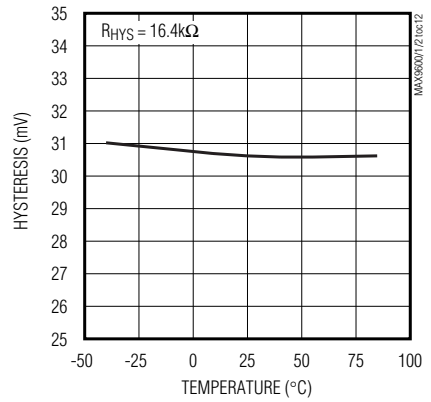

# Dual ECL and Dual/Quad PECL, 500ps, Ultra-High-Speed Comparators

## Typical Operating Characteristics (continued)

( $V_{CC} = 5V$ ,  $V_{EE} = -5.2V$ ,  $V_{CM} = 0V$ ,  $HYS_{-} = \text{open}$  (MAX9600/MAX9601),  $LE_{-} = \text{low}$ ,  $\overline{LE}_{-} = \text{high}$  (MAX9600/MAX9601),  $C_L = 5pF$ ,  $GND = 0V$ ,  $R_L = 50\Omega$  to  $-2V$  (MAX9600),  $V_{CCO_{-}} = 5V$ ,  $R_L = 50\Omega$  to  $3V$  (MAX9601/MAX9602), input slew rate =  $2V/ns$ , duty cycle = 50%,  $T_A = T_{MIN}$  to  $T_{MAX}$ . Typical values are at  $T_A = +25^{\circ}C$ , unless otherwise noted.) (Note 1)

MAX9600/MAX9601/MAX9602

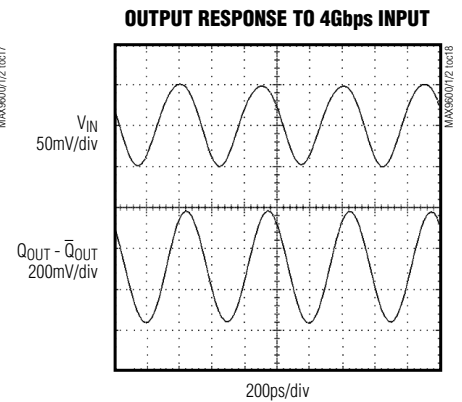
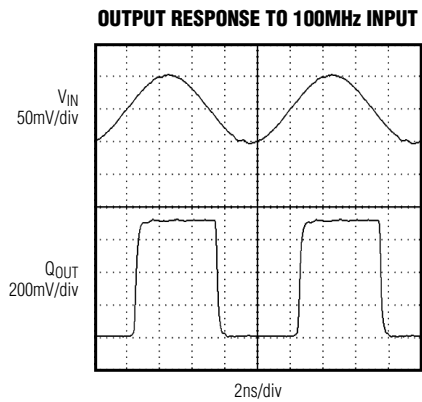
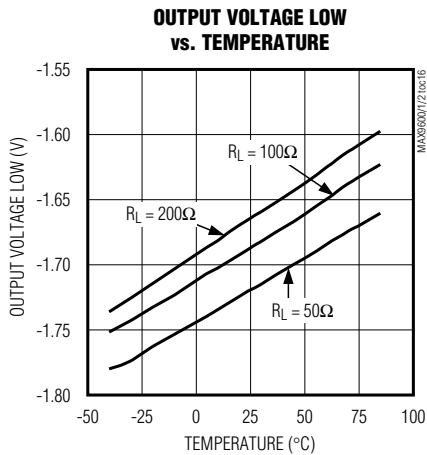
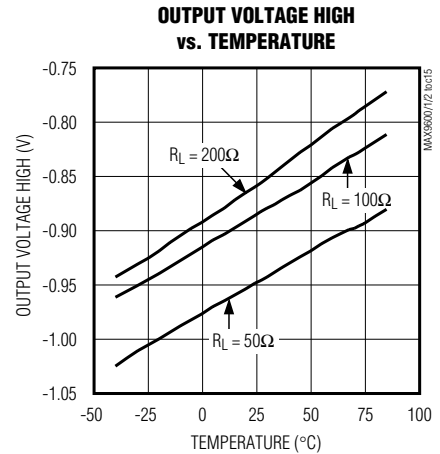
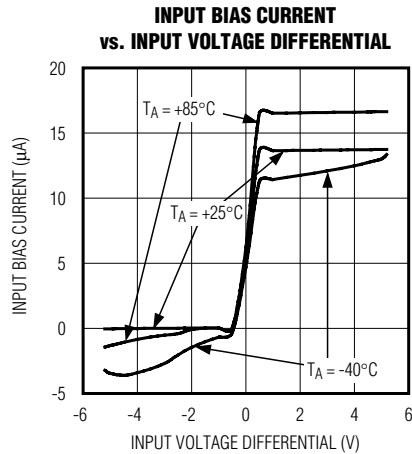
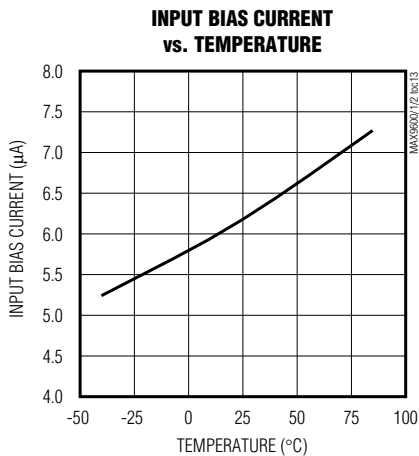

# Dual ECL and Dual/Quad PECL, 500ps, Ultra-High-Speed Comparators

## Timing Diagram

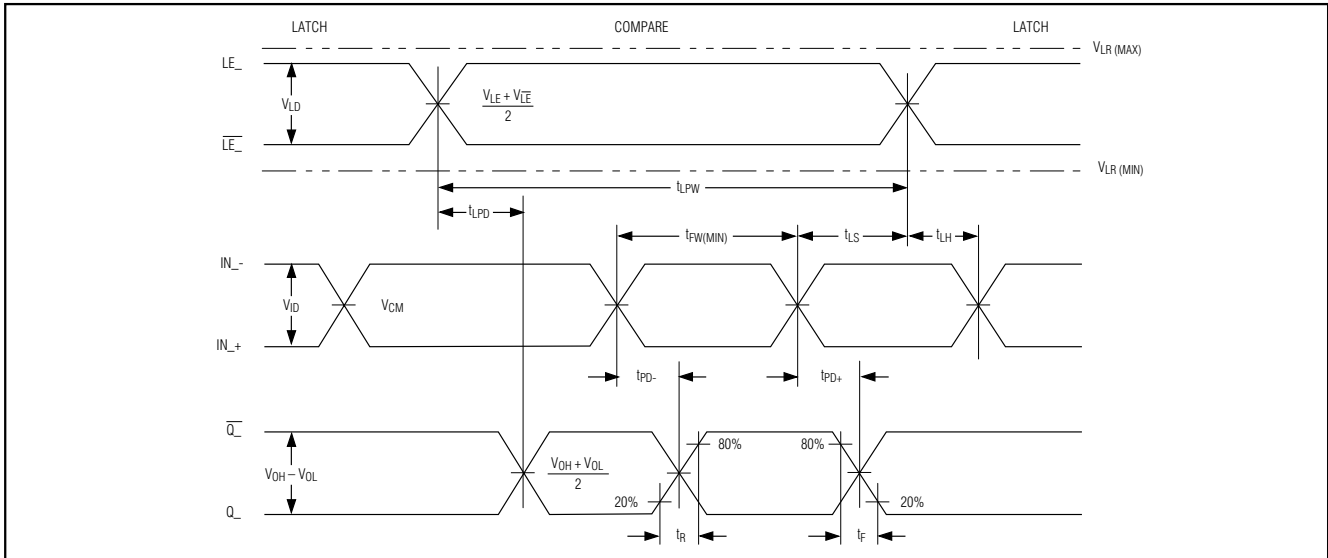

Figure 1. MAX9600/MAX9601/MAX9602 Timing Diagram

## Pin Descriptions

### MAX9600/MAX9601

PIN		NAME	FUNCTION
MAX9600	MAX9601		
1	1	QA	Channel A Output
2	2	$\overline{QA}$	Channel A Complementary Output
3	—	GND	Channel A Output Ground
—	3	VCCOA	Channel A Output Driver Positive Supply
4	4	LEA	Channel A Latch-Enable Input
5	5	$\overline{LEA}$	Channel A Latch-Enable Complementary Input
6, 15	6, 15	VEE	Negative Supply Voltage
7, 14	7, 14	VCC	Positive Supply Voltage
8	8	HYSA	Channel A Hysteresis Input
9	9	INA-	Channel A Minus Input
10	10	INA+	Channel A Plus Input
11	11	INB+	Channel B Plus Input
12	12	INB-	Channel B Minus Input
13	13	HYSB	Channel B Hysteresis Input
16	16	$\overline{LEB}$	Channel B Latch-Enable Complementary Input
17	17	LEB	Channel B Latch-Enable Input
18	—	GND	Channel B Output Ground
—	18	VCCOB	Channel B Output Driver Positive Supply
19	19	$\overline{QB}$	Channel B Complementary Output
20	20	QB	Channel B Output



# Dual ECL and Dual/Quad PECL, 500ps, Ultra-High-Speed Comparators

## Pin Descriptions (continued)

### MAX9602

PIN	NAME	FUNCTION
1	INA+	Channel A Plus Input
2	INA-	Channel A Minus Input
3, 9	V <sub>EE</sub>	Negative Supply Voltage
4	INB+	Channel B Plus Input
5	INB-	Channel B Minus Input
6, 12	V <sub>CC</sub>	Positive Supply Voltage
7	INC+	Channel C Plus Input
8	INC-	Channel C Minus Input
10	IND+	Channel D Plus Input
11	IND-	Channel D Minus Input
13	$\overline{QD}$	Channel D Complementary Output
14	QD	Channel D Output
15	V <sub>CCOD</sub>	Channel D Output Driver Positive Supply
16	$\overline{QC}$	Channel C Complementary Output
17	QC	Channel C Output
18	V <sub>CCOC</sub>	Channel C Output Driver Positive Supply
19	$\overline{QB}$	Channel B Complementary Output
20	QB	Channel B Output
21	V <sub>CCOB</sub>	Channel B Output Driver Positive Supply
22	QA	Channel A Complementary Output
23	QA	Channel A Output
24	V <sub>CCOA</sub>	Channel A Output Driver Positive Supply

### Detailed Description

The MAX9600/MAX9601/MAX9602 ultra-high-speed comparators feature extremely low propagation delay (500ps). These dual and quad comparators minimize channel-to-channel skew (10ps) and are designed for low propagation delay dispersion. These features make them ideal for applications where high-fidelity tracking of narrow pulses and low timing dispersion is critical. The devices operate from either standard supply levels of -5.2V/+5V or shifted levels of -4.2V/+6V.

The differential input stage accepts a wide range of signals in the common-mode range from (V<sub>EE</sub> + 3V) to (V<sub>CC</sub> - 2V) with a CMRR of 70dB (typ). The outputs are complementary digital signals, compatible with ECL and PECL systems, and provide sufficient current to directly drive transmission lines terminated in 50Ω. The ultra-fast operation makes signal processing possible at a data rate up to 4Gbps. Figure 2 shows a 1Gbps (500MHz) example with an input-signal level of 100mV<sub>p-p</sub>.

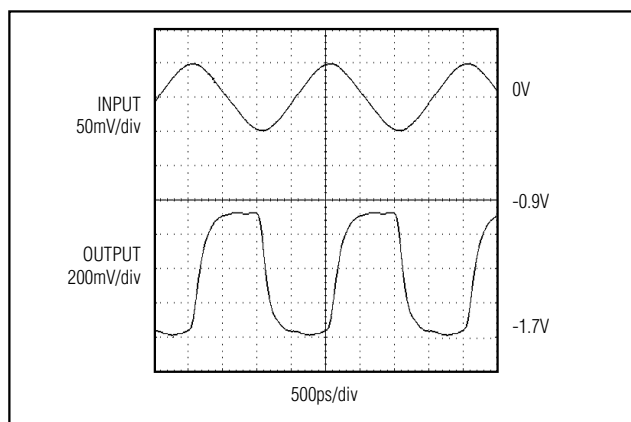

Figure 2. Signal Processed at 500MHz with Input-Signal Level of 100mV<sub>RMS</sub>.

# Dual ECL and Dual/Quad PECL, 500ps, Ultra-High-Speed Comparators

The MAX9600/MAX9601 incorporate latch-enable and hysteresis control. Hysteresis rejects noise and prevents oscillations on low-slew input signals. The latch-enable control permits tracking or sampling mode of operations. Drive the complementary latch enable with standard ECL logic for MAX9600 and PECL logic for MAX9601. The MAX9602 quad-channel PECL output comparator does not include the latch-enable or hysteresis control functions.

## Applications Information

### Layout

Special layout precautions exist due to the large gain-bandwidth characteristic of the MAX9600/MAX9601/MAX9602. Use a printed circuit board with a good, low-inductance ground plane. Mount 0.01 $\mu$ F ceramic decoupling capacitors as close to the power-supply inputs as possible. Minimize lead lengths on the inputs and outputs to avoid unwanted parasitic feedback around the comparators. Use surface-mount chip components to minimize lead inductance. Pay close attention to the bandwidth of the decoupling and terminating components.

Use microstrip layout and terminations at the input and output. Avoid discontinuities in differential impedance. Maximize common-mode noise immunity by maintaining the distance between differential traces and avoid sharp corners. Minimize the number of vias to prevent impedance discontinuities. Match the electrical length of the traces to minimize skew.

### Input Slew-Rate Requirements

As with all high-speed comparators, the high gain-bandwidth product of these devices can create oscillation problems when the input goes through the threshold region. This is typically due to parasitic paths, which cause positive feedback to occur. For clean switching without oscillation or steps in the output waveform for the MAX9600/MAX9601, use an input with a slew rate of 5V/ $\mu$ s or faster. For the MAX9602, use a slew rate of 25V/ $\mu$ s or faster. The tendency of the part to oscillate is a function of the layout and source impedance of the circuit employed. Poor layout and larger source impedance increases the minimum slew-rate requirement. Adding hysteresis accommodates slower inputs (see the *Hysteresis* section).

### Hysteresis (MAX9600/MAX9601)

Hysteresis can be introduced to prevent oscillation or multiple transitions due to noise. The MAX9600/MAX9601 feature current-controlled hysteresis, which is set by placing a resistor between HYS\_ and GND. The value of the current-setting resistor is determined by the

output voltage of 2.5V at HYS\_ divided by the desired hysteresis current level in the range of 0 to 200 $\mu$ A. R<sub>HYS</sub> of 10k $\Omega$  to 35k $\Omega$  resistors provides hysteresis of 60mV to 5mV (see the Hysteresis vs. R<sub>HYS</sub> to GND graph in the *Typical Operating Characteristics* section). For a zero hysteresis (0 $\mu$ A hysteresis current), leave HYS\_ open or connect it to V<sub>CC</sub>.

### Propagation Delay Dispersion

Propagation delay dispersion is defined as a variation in propagation delay as a function of change in input conditions. In an automatic test system pin-driver electronics, for example, the dispersion determines the maximum edge resolution.

Many factors can affect the dispersion, such as common-mode voltage, overdrive, input slew rate, duty cycle, and pulse width. The typical propagation delay dispersions of the MAX9600/MAX9601/MAX9602 are less than 10ps to 40ps (see the *Typical Operating Characteristics* and *Electrical Characteristics* sections).

### Comparators with Latch Enable (MAX9600/MAX9601)

The latch-enable function allows the comparator to be used in a sampling mode. When LE\_ is low ( $\overline{\text{LE}}_$  is high), the comparator tracks the input signal. When LE\_ is driven high ( $\overline{\text{LE}}_$  is low), the outputs are forced to an unambiguous logic state, dependent on the input conditions at the time of the latch input transition. If the latch-enable function is not used, connect the appropriate LE\_ input to a low ECL/PECL logic, and its complementary  $\overline{\text{LE}}_$  input to a high ECL/PECL logic level (see Table 1).

The input range of the MAX9600 differential latch-enable inputs is 400mV to 2V. The logic-input swing excursion must fall within an input-voltage range (V<sub>LR</sub>) of -2V to 0 to work properly. The input range of the MAX9601 differential latch-enable inputs is 250mV to 3.5V. The logic-input swing excursion must fall within an input-voltage range (V<sub>LR</sub>) of 0 to 3.5V for (V<sub>CCO\_</sub> < 3.5V) or V<sub>LR</sub> of (V<sub>CCO\_</sub> - 3.5V) to V<sub>CCO\_</sub> for (V<sub>CCO\_</sub>  $\geq$  3.5V) to work properly.

Table 1. Latch-Enable Truth Table

LATCH-ENABLE INPUT		OPERATION
LE_	$\overline{\text{LE}}_$	
0	1	Compare Mode. Output follows input state.
1	0	Latch Mode. Output latches to last known output state.
0	0	Invalid condition, output is in unknown state.
1	1	Invalid condition, output is in unknown state.



# Dual ECL and Dual/Quad PECL, 500ps, Ultra-High-Speed Comparators

## Package Information

(The package drawing(s) in this data sheet may not reflect the most current specifications. For the latest package outline information, go to [www.maxim-ic.com/packages](http://www.maxim-ic.com/packages).)

SYMBOL	COMMON DIMENSIONS			
	MILLIMETERS		INCHES	
	MIN.	MAX.	MIN.	MAX.
A	—	1.10	—	.043
A <sub>1</sub>	0.05	0.15	.002	.006
A <sub>2</sub>	0.85	0.95	.033	.037
b	0.19	0.30	.007	.012
b <sub>1</sub>	0.19	0.25	.007	.010
c	0.09	0.20	.004	.008
c <sub>1</sub>	0.09	0.14	.004	.006
D	SEE VARIATIONS		SEE VARIATIONS	
E	4.30	4.50	.169	.177
e	0.65 BSC		.026 BSC	
H	6.25	6.55	.246	.258
L	0.50	0.70	.020	.028
N	SEE VARIATIONS		SEE VARIATIONS	
α	0°	8°	0°	8°

JEDEC	N	VARIATIONS			
		MILLIMETERS		INCHES	
		MIN.	MAX.	MIN.	MAX.
AB-1	14	4.90	5.10	.193	.201
AB	16	4.90	5.10	.193	.201
AC	20	6.40	6.60	.252	.260
AD	24	7.70	7.90	.303	.311
AE	28	9.60	9.80	.378	.386

**NOTES:**  
 1. DIMENSIONS D AND E DO NOT INCLUDE FLASH  
 2. MOLD FLASH OR PROTRUSIONS NOT TO EXCEED 0.15mm PER SIDE  
 3. CONTROLLING DIMENSION: MILLIMETER  
 4. MEETS JEDEC OUTLINE MD-153. SEE JEDEC VARIATIONS TABLE  
 5. 'N' REFERS TO NUMBER OF LEADS  
 6. THE LEAD TIPS MUST LIE WITHIN A SPECIFIED ZONE. THIS TOLERANCE ZONE IS DEFINED BY TWO PARALLEL PLANES. ONE PLANE IS THE SEATING PLANE, DATUM [-C-]; THE OTHER PLANE IS AT THE SPECIFIED DISTANCE FROM [-C-] IN THE DIRECTION INDICATED

**DALLAS SEMICONDUCTOR** **MAXIM**  
 PROPRIETARY INFORMATION  
 TITLE: PACKAGE OUTLINE, TSSOP 4.40mm BODY  
 APPROVAL: \_\_\_\_\_ DOCUMENT CONTROL NO. 21-0066 REV. F 1/1

TSSOP4.40mm:EP5

Maxim cannot assume responsibility for use of any circuitry other than circuitry entirely embodied in a Maxim product. No circuit patent licenses are implied. Maxim reserves the right to change the circuitry and specifications without notice at any time.

12 **Maxim Integrated Products, 120 San Gabriel Drive, Sunnyvale, CA 94086 408-737-7600**