

Product Features

- 50 ~ 3500MHz
- InGaP HBT MMIC
- 33.5dBm Output IP3
- 15.5dB Gain
- 18.8dBm P1 dB
- On Chip Active bias
- Pb Free / RoHS Standard

Application

- CDMA, W-CDMA Medium Power Amplifier
- High Linearity Drive Amplifier



Package Type: SOT-89

Description

AP409 is a gain block amplifier designed with InGaP HBT MMIC in a low cost SOT-89 package. This MMIC amplifier is designed for use as driver devices for infrastructure equipment in the 50~3500MHz Wireless technologies such as Cellular, GSM, PCS CDMA, W-CDMA.

Specifications

PARAMETER	Units	Min	Typ	Max	Typ	
Gain (S_{21})	dB	14	15.5		15.3	15.2
Input Return Loss (S_{11})	dB		-18		-22	-22
Output Return Loss (S_{22})	dB		-20		-19	-19
Output 3 rd Order Intercept Point (OIP3)	dBm	+30	+33.5		+30	+27
Output 1dB compression Point (P_{1dB})	dBm		+18.8		+18	+16.5
Noise Figure	dB		5		5.1	5.1
DC Operating Current	mA	55	70	85	65	52
Supply Voltage	Vdc		+5		+4.8	+4.5
Thermal Resistance (R_{th})	°C/W			150		

Test Condition

① 900MHz, Vdc=5V at 25°C

② OIP3 is measured with two tones, at an output power of +5dBm/tone separated by 1MHz.

Absolute Maximum Ratings

PARAMETER	Rating	Remark
Operating Case Temperature (°C)	-40 ~ +85	
Storage Temperature (°C)	-50 ~ +150	
Supply Voltage	+6	
Junction Temperature (°C)	+220	

Performance Charts ($V_d=5V, I_d=70mA, T_c=25^\circ C$)

Gain vs. Frequency

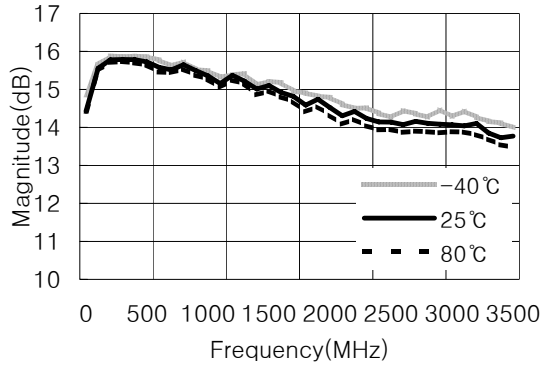

OIP3 vs. Frequency

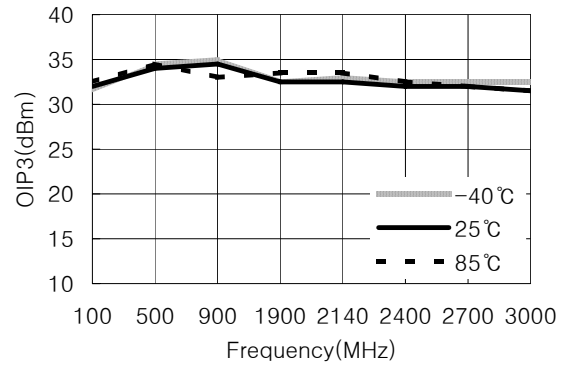

Input Return Loss vs. Frequency

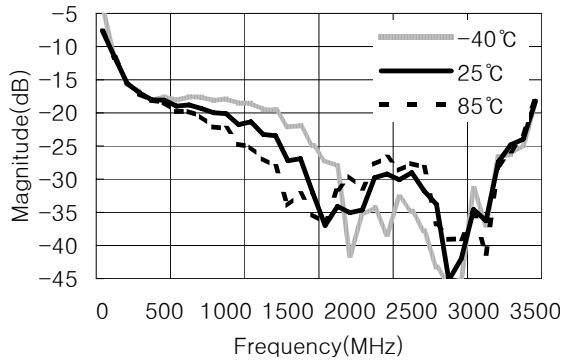

Output Return Loss vs. Frequency

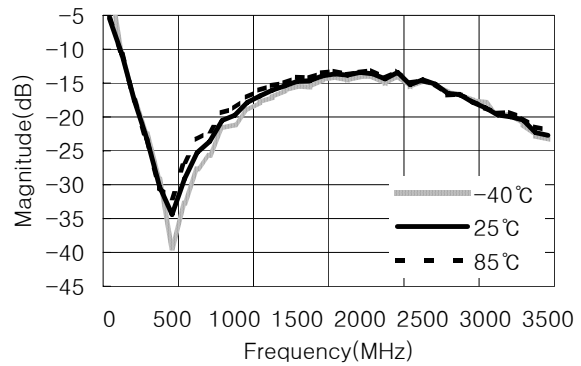

Noise Figure vs. Frequency

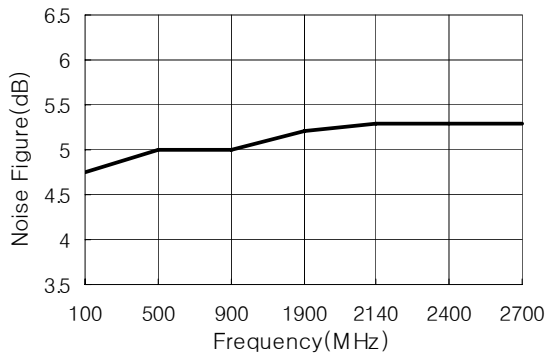

P1dB vs. Frequency

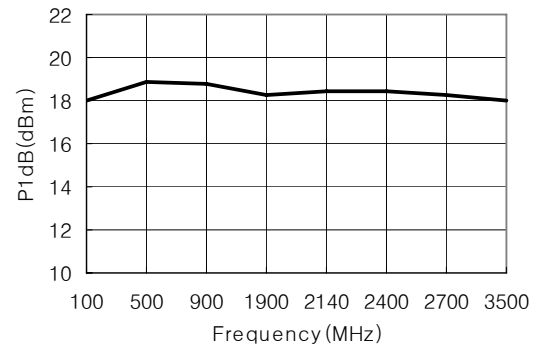

Block Diagram

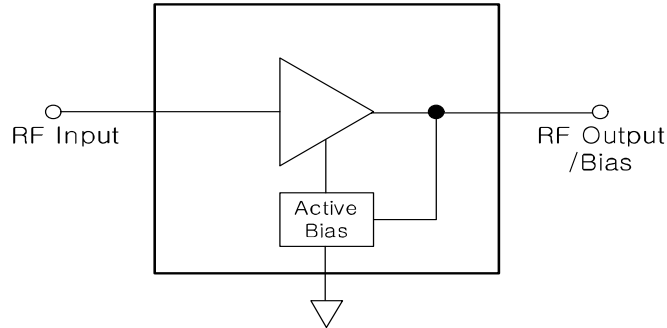

Application Circuit

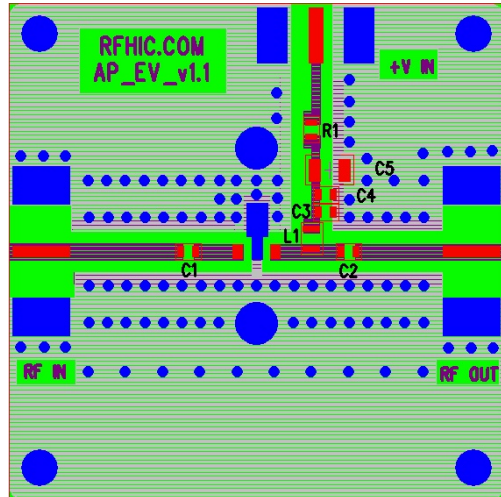
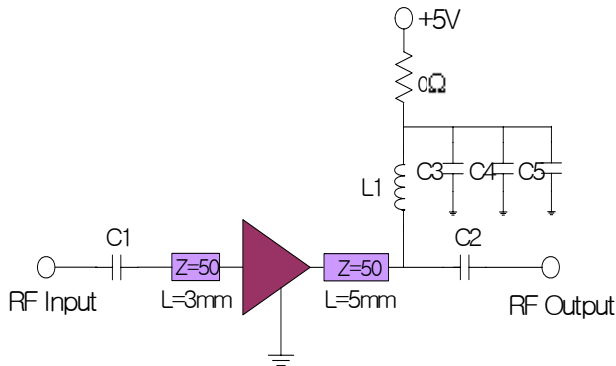

Recommended Component Values

	70MHz	500MHz-3000MHz
L1	560nH	100nH
C1,C2,C3	0.1uF	1000pF
C4	1000pF	0.1uF
C5	4.7uF/16V	4.7uF/16V

Recommended Bias Resistor Values

Vsupply	Rbias(5V)	Rbias(4.8V)	Rbias(4.5V)
6V	14	18	28
7V	28	33	48
8V	42	49	67
9V	57	64	86

Performance Charts ($V_d=5V, I_d=70mA, T_c=25^\circ C$)

Frequency	MHz	100	500	900	1900	2140	2400	2700	3500
Gain	dB	15.6	15.6	15.5	14.8	14.5	14.4	14.1	13.5
S11	dB	-11	-17	-18	-35	-33	-29	-26	-15
S22	dB	-10	-38	-20	-13	-13	-13	-14	-18
OIP3	dBm	32.5	33.5	33.5	32.5	32	31.5	31.5	
P1dB	dBm	18	18.9	18.8	18.3	18.4	18.4	18.3	18
Noise Figure	dB	4.75	5	5	5.2	5.3	5.3	5.3	

Gain vs. Frequency

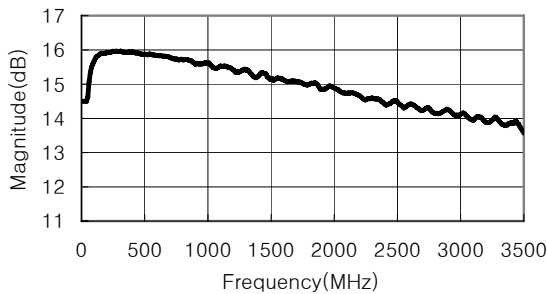

OIP3 vs. Frequency

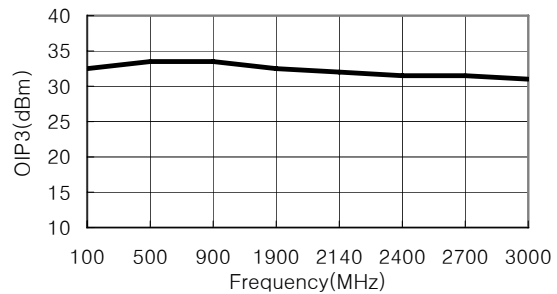

Input Return Loss vs. Frequency

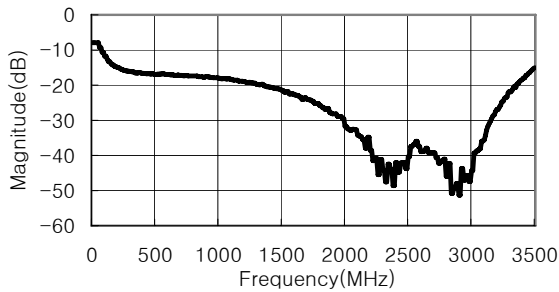

Output Return Loss vs. Frequency

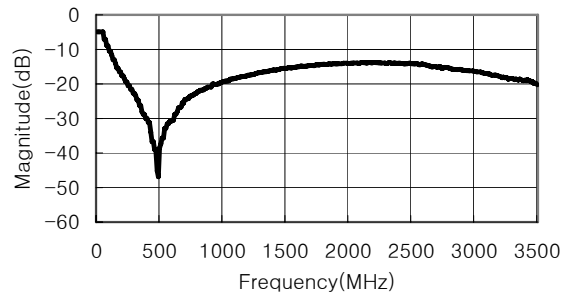

70MHz Performance

Typical Specifications	
Frequency	50~200MHz
Gain(S21)	16dB
Return Loss(S11)	-15dB
Return Loss(S22)	-23dB
OIP3	32.5dBm
Noise Figure	4.7dB
P1dB	19dBm

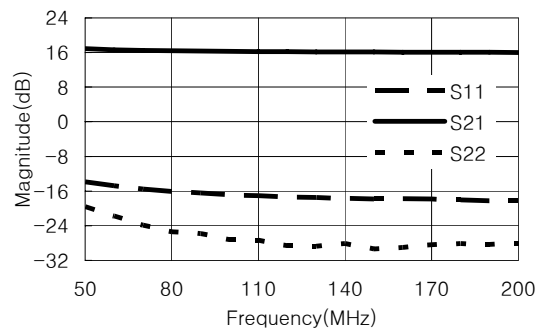

Performance Charts ($V_d=4.8V$, $I_d=65mA$, $T_c=25^\circ C$)

Frequency	MHz	500	880	960	1860	2140	2700	3500
Gain	dB	15.5	15.3	15.3	14.6	14.3	12.6	12.2
S11	dB	-19	-22	-23	-27	-26	-26	-17
S22	dB	-31	-19	-17	-13	-14	-15	-10
OIP3	dBm	30.5	30	30	30	29	28.5	28
P1dB	dBm	18.1	18	18	17.5	17.1	16.5	16
Noise Figure	dB	5.1	5.1	5.1	5.2	5.2	5.3	5.3

S-Parameter vs. Frequency

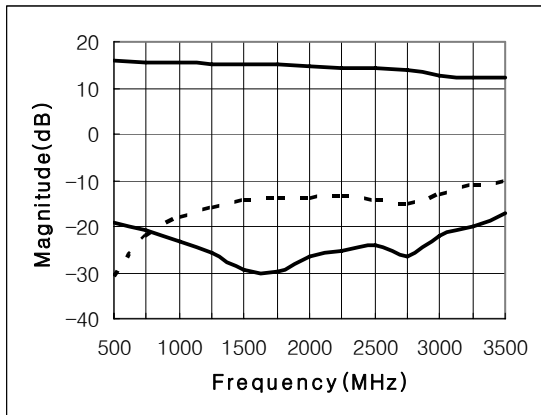

OIP3 vs. Frequency

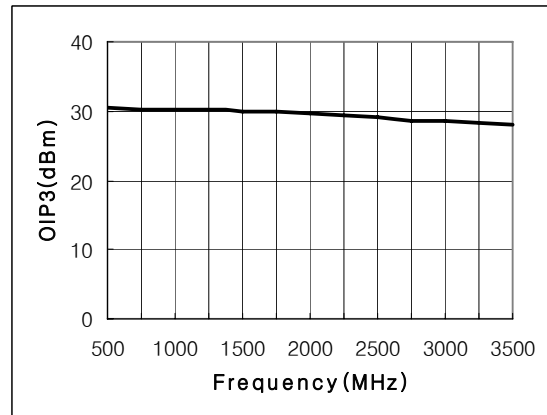

Noise Figure vs. Frequency

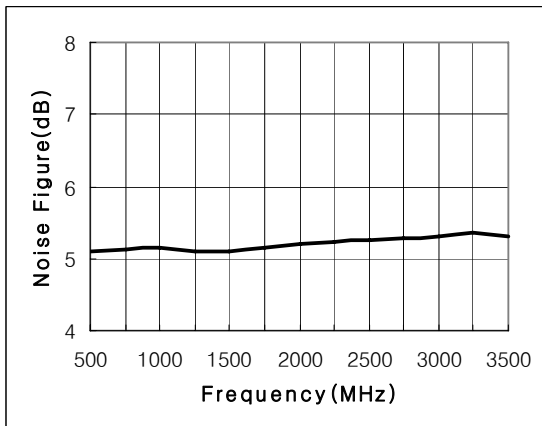

P1dB vs. Frequency

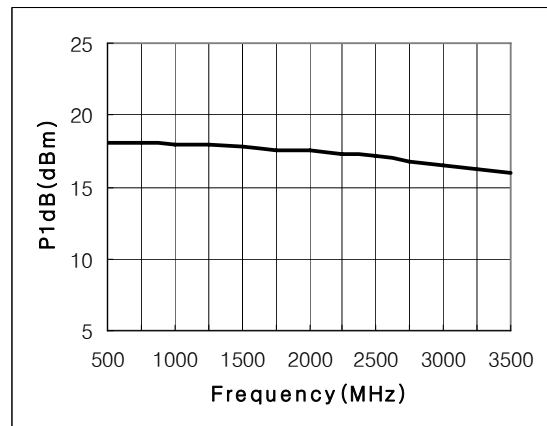

Performance Charts ($V_d=4.5V$, $I_d=52mA$, $T_c=25^\circ C$)

Frequency	MHz	500	880	960	1860	2140	2700	3500
Gain	dB	15.5	15.2	15.2	14.5	14.1	12.4	12
S11	dB	-19	-22	-23	-27	-26	-26	-17
S22	dB	-30	-19	-17	-13	-14	-15	-10
OIP3	dBm	27.5	27	27	26	25	24	24
P1dB	dBm	16.7	16.5	16.4	15.6	15.2	14.9	14.1
Noise Figure	dB	5.1	5.1	5.1	5.2	5.25	5.27	5.3

S-Parameter vs. Frequency

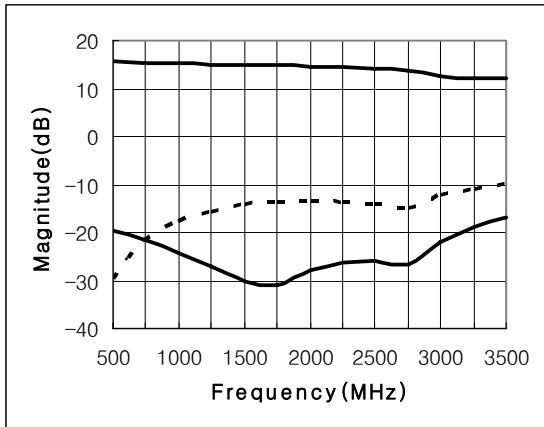

OIP3 vs. Frequency

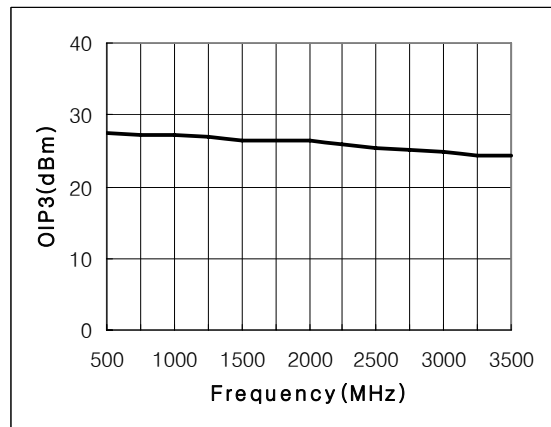

Noise Figure vs. Frequency

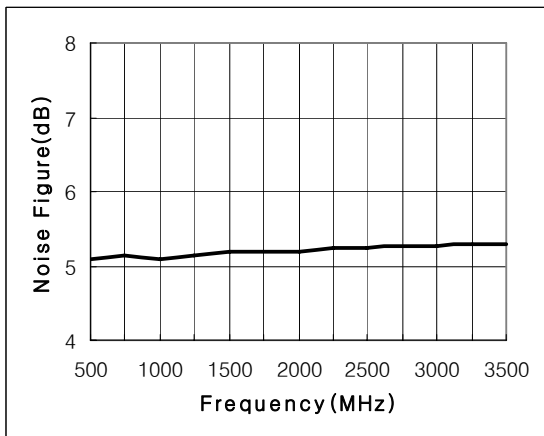

P1dB vs. Frequency

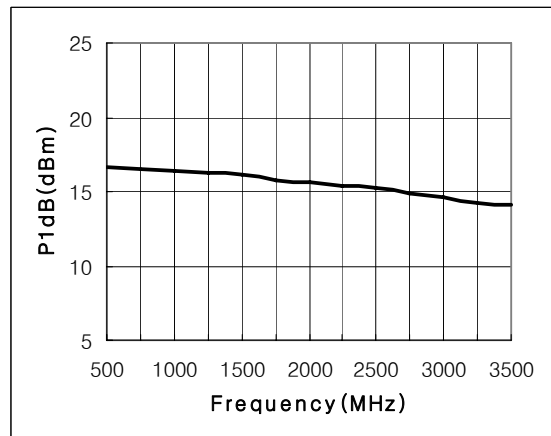

Package Dimensions (Type: SOT-89)

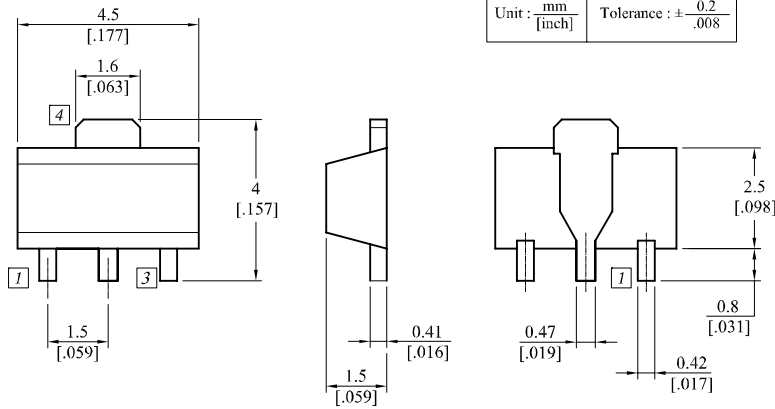

Pin No	Function
1	Input
2	Ground
3	Output/Bias
4	Ground

! ESD sensitive
 Observe precautions for handling, testing and packaging.

Recommended Pattern

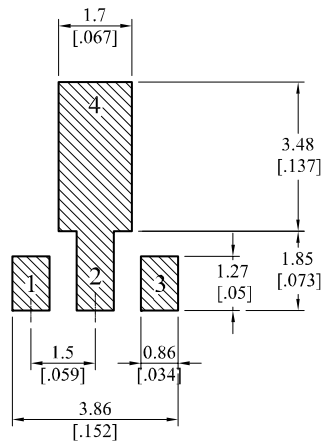

Recommended Mounting Configuration

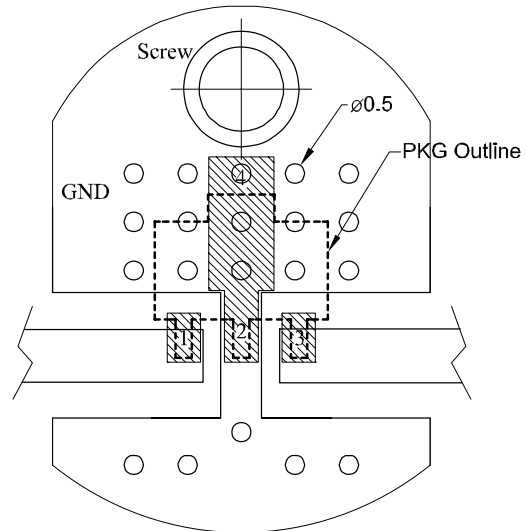

RFHIC Corporation (RFHIC) reserves the right to make changes to any products herein or to discontinue any product at any time without notice. RFHIC do not assume any liability for the suitability of its products for any particular purpose, and disclaims any and all liability, including without limitation consequential or incidental damages. The product specifications herein expressed have been carefully checked and are assumed to be reliable. However, RFHIC disclaims liability for inaccuracies and strongly recommends buyers to verify that the information they are using is current before placing purchase orders. RFHIC products are not intended for use in life support equipment or application where malfunction of the product can be expected to result in personal injury or death. Buyer uses or sells such products for any such unintended or unauthorized application, buyer shall indemnify, protect and hold RFHIC and its directors, officers, stockholders, employees, representatives and distributors harmless against any and all claims arising out of such use. RFHIC's liability under or arising out of damages, claims of whatsoever kind and nature which RFHIC products could cause shall be limited in amount to the net purchase price of the products sold to buyer by RFHIC.

- Tel : 82-31-250-5011
- rfsales@rfhic.com

- All specifications may change without notice.
- Version 5.3