1 mW 14 Pin DIL Cooled Laser Modules

Technical Data

LSCX110

Features

- **1 Milliwatt Optical Output at 25 mA above Threshold, 25°C**
- **Center Wavelength between 1280 nm and 1330 nm**
- **Wide Modulation Bandwidth:**
LSC2110 - 800 MHz
LSC4110 - 1.2 GHz
- **Wide Operating Temperature Range: -40°C to +85°C**
- **Alternative Package Styles:**
LSC2110 - 14 Pin DIL
LSC4110 - 14 Pin “Butterfly”

Applications

- **Telecommunications**
- **Local Area and Metropolitan Area Networks**
- **Point-to-Point Data Communications**
- **Fiber Optic Sensors**
- **Cable Television**
- **Military Communications and Control Systems**
- **Instrumentation**

Description

LSCX110 laser modules are highly reliable fiber optic light sources operating in the 1300 nanometer band. The internal semiconductor lasers are based upon InGaAsP buried heterostructure (BH) technology and fabricated by the Metal Organic Vapor Phase Epitaxy (MOVPE) process, resulting in long lifetimes and modest threshold currents.

LSCX110 packages include a photodiode for monitoring the laser output, a thermistor for monitoring laser heatsink temperature and a Peltier effect thermoelectric cooler (TEC). A heatsink mounting flange is incorporated into the base of the 14 pin “butterfly” package and a “bullhorn” type flange is used on the 14 pin DIL package.



Laser Safety Warning

This device is a Class IIIb (3b) Laser Product. It may emit invisible laser radiation if operated with the fiber pigtail disconnected. To avoid possible eye damage do not look into an unconnected fiber pigtail during laser operation. Do not exceed specified operating limits.

Pin Connections

LSC2110

Top View

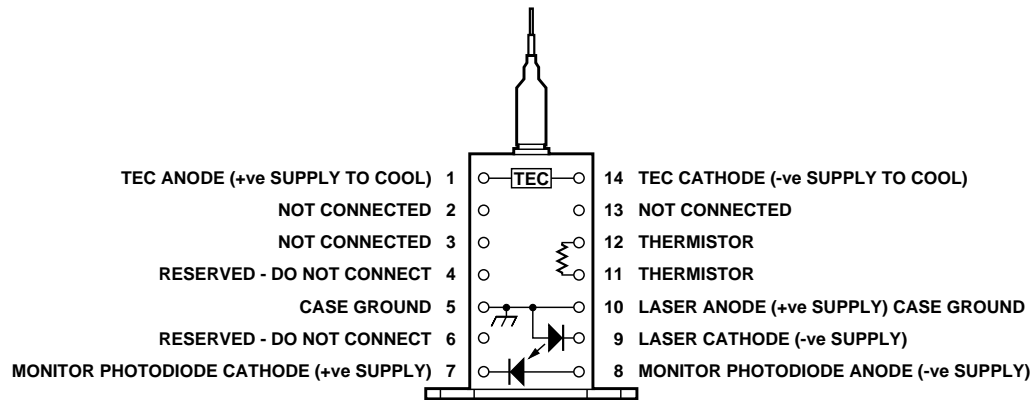

LSC4110

Top View

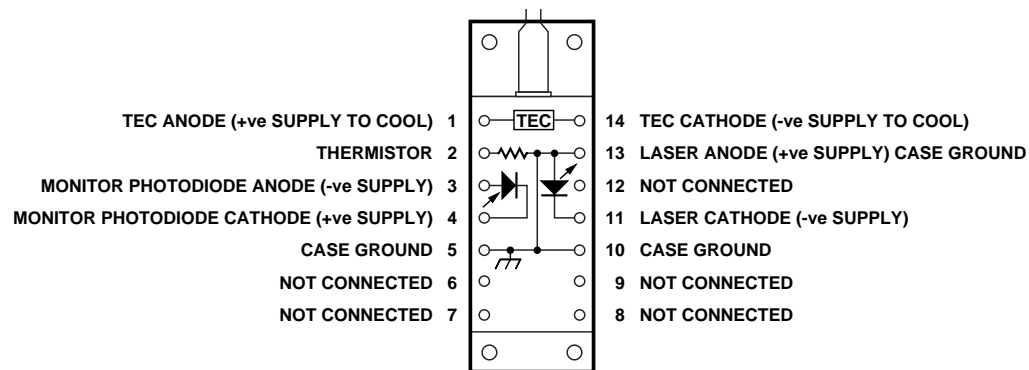

LSCX110 Laser Diode Typical Operating Characteristics

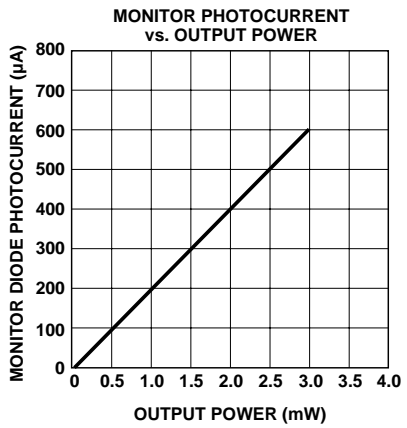
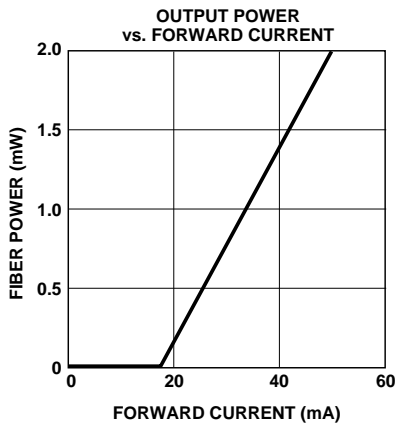
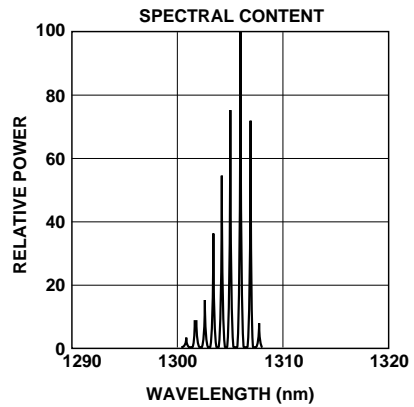
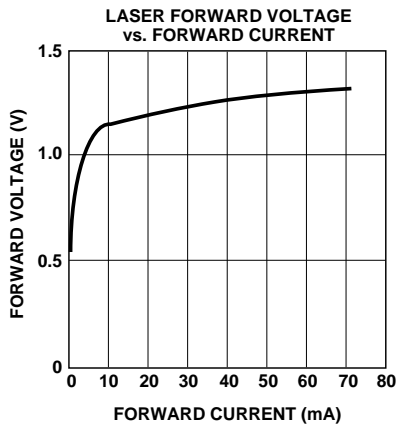

Absolute Maximum Ratings

Absolute maximum limits mean that no catastrophic damage will occur if the product is subjected to these ratings for short periods, provided each limiting parameter is in isolation and all other parameters have values within the performance specification. It should not be assumed that limiting values of more than one parameter can be applied to the product at the same time.

Parameter	Symbol	Conditions	Limits		Units
			Min.	Max.	
Laser Forward Current	I _f	DC	-	150	mA
Laser Reverse Current	I _r	DC	-	100	μA
Laser Reverse Voltage	V _{Ir}	DC	-	2	V
Photodiode Reverse Voltage	V _r	DC	-	10	V
Photodiode Forward Current	I _{pf}	DC	-	1	mA
Operating Temperature (Case)	C	Pf = 1 mW	-40	+85	°C
Storage Temperature	T _s		-40	+85	°C
Relative Humidity RH			0-0	non-condensing	%RH
Fiber Pull Strength			-	10	N
Mechanical Shock		Mil Std 883, Method 2002, Test Condition A			
Vibration		Mil Std 883, Method 2007, Test Condition A			

Performance Specifications

Parameter	Symbol	Test Conditions	Test Limits		Units
			Min.	Max.	
LASER		CW, R _t = 10 kΩ, T _c = ~25°C unless otherwise specified			
Threshold Current	I _{th}		5	25	mA
I _{th} Change with Temperature	ΔI _{th} /ΔT	T _c = 65°C to 85°C	-	2.5	%/°C
Peak Optical Output	P _f	P _f = P _f @ I _{th} + 25 mA	1	2.5	mW
Optical Output Power	P _{th}	P _{th} = P _f @ I _{th} - 2 mA	-	50	μW
Slope Efficiency	η		0.04	0.1	mW/mA
Forward Voltage	V _f		-	1.8	V
Differential Resistance	R _d	dV/dI	-	10	Ω
Center Wavelength	λ _c	Note 1	1280	1330	nm
λ _c Change with Temperature	Δλ _c /ΔT	T _c = 65°C to 85°C, ΔT = -40°C	-	0.4	nm/°C
Linewidth	Δλ	FWHM (2.35 σ), Note 1	-	5	nm
Rise Time	τ _r	10% to 90%: I _{th} to P _f = 1 mW	-	0.5	ns
Fall Time	τ _f	90% to 10%: P _f = 1 mW to I _{th}	-	0.5	ns
Small Signal Frequency Response					
LSC2110	Bw	m = 0.8	800	-	MHz
LSC4110	Bw	m = 0.8	1.2	-	GHz

Note:

1. Modulated measurements also available.

Performance Specifications (cont'd.)

Parameter	Symbol	Test Conditions	Test Limits		Units
			Min.	Max.	
MONITOR PHOTODIODE		Rt = 10 kΩ, Tc = ~25°C, CW, Pf = 1 mW, Vr = 5 V (Note 2) unless otherwise specified			
Photocurrent	Im		80	800	μA
Responsivity	R		0.08	0.8	A/W
Dark Current	Id	Pf = 0 mW	-	20	nA
Tracking Error	ΔR	Im = Im @ (Pf = 1 mW, Tc = 25°C)			
		ΔT = -40°C, Tc = 85°C	-	± 0.5	dB
		ΔT = +65°C, Tc = -40°C	-	± 0.5	dB

Note:

2. Monitor Photodiode will also operate under zero bias conditions.

Parameter	Symbol	Test Conditions	Test Limits		Units
			Min.	Max.	
THERMISTOR		Tc = 25°C, Pf = 0 mW unless otherwise specified			
Resistance	Rt		9.5	10.5	kΩ
Temperature Coefficient of Rt	ΔRt/ΔT		Typ -4.4		%dR/K
β Constant	β	0°C to 50°C	Typ 3900		°K

Parameter	Symbol	Test Conditions	Test Limits		Units
			Min.	Max.	
TEC		Tc = 25°C, Pf = 1 mW unless otherwise specified			
TEC Cooling Current	Ic	ΔT = -40°C, Tc = 85°C	-	1.0	A
TEC Heating Current	Ih	ΔT = 65°C, Tc = -40°C	-	1.0	A
Voltage	Vc	ΔT = -40°C to +65°C	-	2.0	V

Fiber Pigtail: Tight jacketed, self-mode stripping, single mode fiber

Parameter	Minimum	Maximum	Units
Length	1.0	-	m
Spot Size (mode radius)	4.5	5.5	μm
Cladding Diameter	122	128	μm
Core/Cladding Concentricity	-	1.0	μm
Secondary Jacket Diameter	0.8	1.0	mm
Effective Cut-off Wavelength	1150	1240	nm

Hewlett-Packard can offer a ruggedized fiber pigtail for this product range if extreme mechanical strength is required. The pigtail length can be customized to your specific length, with a connector, to a tolerance of ±25 mm.

LSC2110 Mechanical Outline

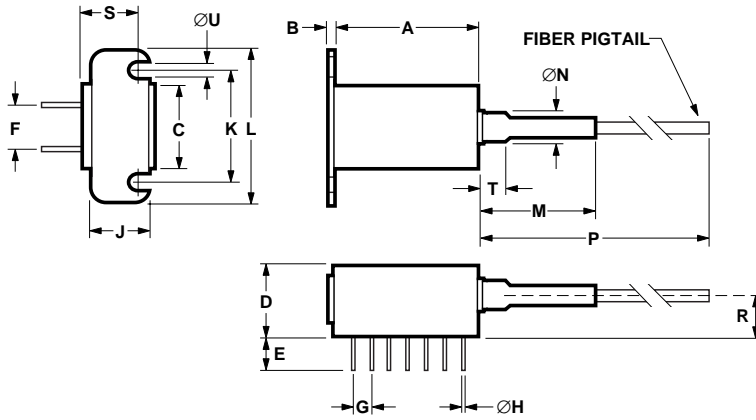

DIM.	MIN.	MAX.	DIM.	MIN.	MAX.
A	20.68	20.98	K	19.05 NOM.	
B	0.90	1.10	L	25.10	25.70
C	12.55	13.00	M	30.00 NOM.	
D	8.51	9.60	ØN	-	4.20
E	6.10	6.60	P	1000	-
F	7.62 NOM.		R	5.80	6.20
G	2.54 NOM.		S	6.00 NOM.	
ØH	0.457 NOM.		T	-	6.00
J	7.01	7.21	ØU	3.17 NOM.	

ALL DIMENSIONS IN MILLIMETERS

LSC4110 Mechanical Outline

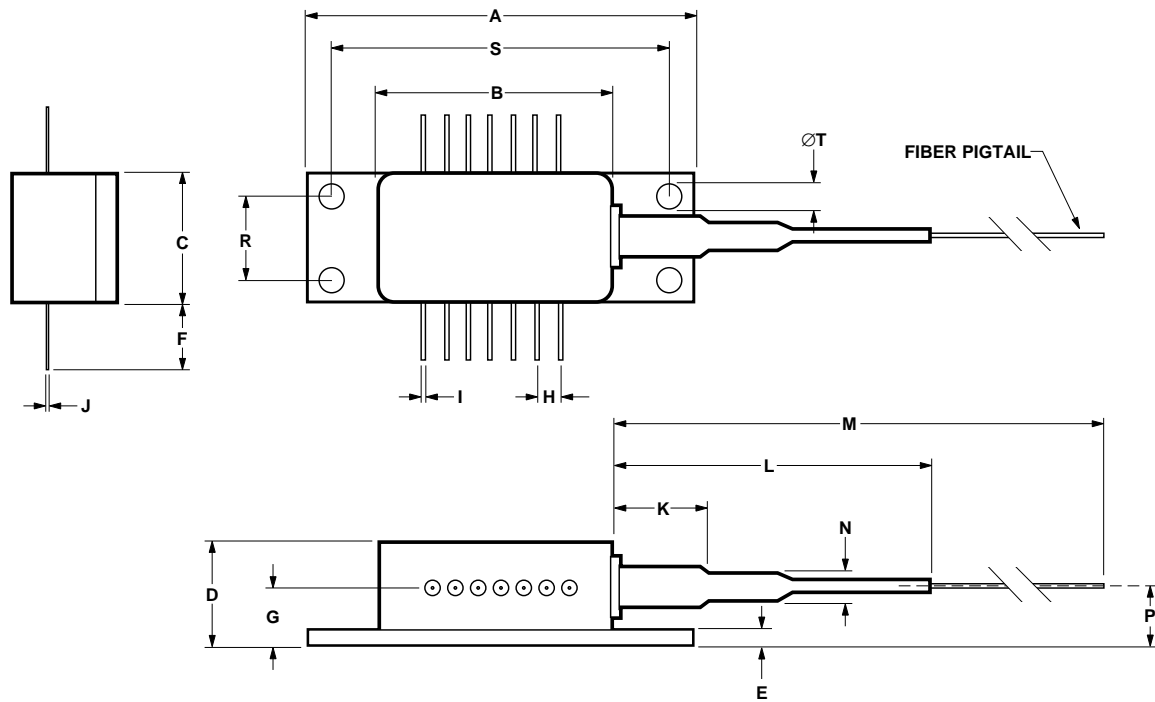

DIM.	MIN.	MAX.	DIM.	MIN.	MAX.
A	29.85	30.15	J	0.25 NOM.	
B	20.65	20.95	K	19.05 NOM.	
C	12.45	12.75	L	30.00 NOM.	
D	9.05	9.35	M	1000	-
E	1.40	1.60	N	4.05	4.35
F	4.90	6.10	P	5.25	5.55
G	5.45	5.75	R	8.85	9.15
H	2.54 NOM.		S	25.85	26.15
I	0.38 NOM.		$\varnothing T$	1.90	2.10

ALL DIMENSIONS IN MILLIMETERS

Ordering Information

LSCX110 - XX

Connector Type:

FP = FC/PC

ST = ST[®]

SC = SC

DN = DIN

BI = Biconic

D4 = D4

SF = Super Polish FC/PC

Package Style:

2 = 14 PIN DIL

4 = 14 PIN "Butterfly"

Handling Precautions

1. The LSCX110 can be damaged by current surges or overvoltage.
2. Power supply transient precautions should be taken.
3. Normal handling precautions for electrostatic sensitive devices should be taken.

CDRH Certification

Hewlett-Packard Ltd
Whitehouse Road
Ipswich, Suffolk IP1 5PB
England

Manufactured: ____ Serial No. ____
Model No. _____

This product conforms to the applicable requirements of 21 CFR 1040 at the date of manufacture.

Laser Warning

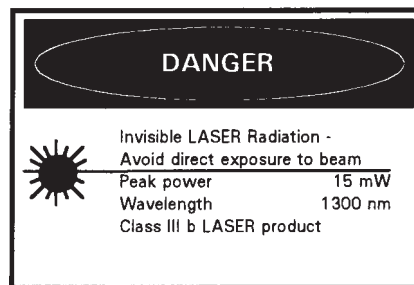

ST[®] is a Registered Trademark of AT&T.