



Technical Data Sheet

Infrared Remote-control Receiver Module

IRM-8601S

Features

- High protection ability against EMI .
- Oval lens to improve the receive angles.
- Line-up for various center carrier frequencies.
- Low voltage and low power consumption.
- High immunity against ambient light.
- Photodiode with integrated circuit.
- TTL and CMOS compatibility.
- Long reception distance.
- High sensitivity.



Descriptions

The device is a miniature type infrared remote control system receiver which has been developed and designed by utilizing the most updated IC technology. The PIN diode and preamplifier are assembled on lead frame, the epoxy package is designed as an IR filter. The demodulated output signal can directly be decoded by a microprocessor.

Applications

1. Optical switch
2. Light detecting portion of remote control
 - AV instruments such as Audio, TV, VCR, CD, MD, etc.
 - Home appliances such as Air-conditioner, Fan , etc.
 - The other equipments with wireless remote control.
 - CATV set top boxes
 - Multi-media Equipment

Device Selection Guide

PART	MATERIAL	COLOR
Chip	Silicon	-----
Metal can	Tinplate	Silver-white
Package	Epoxy	Black

Package Dimensions

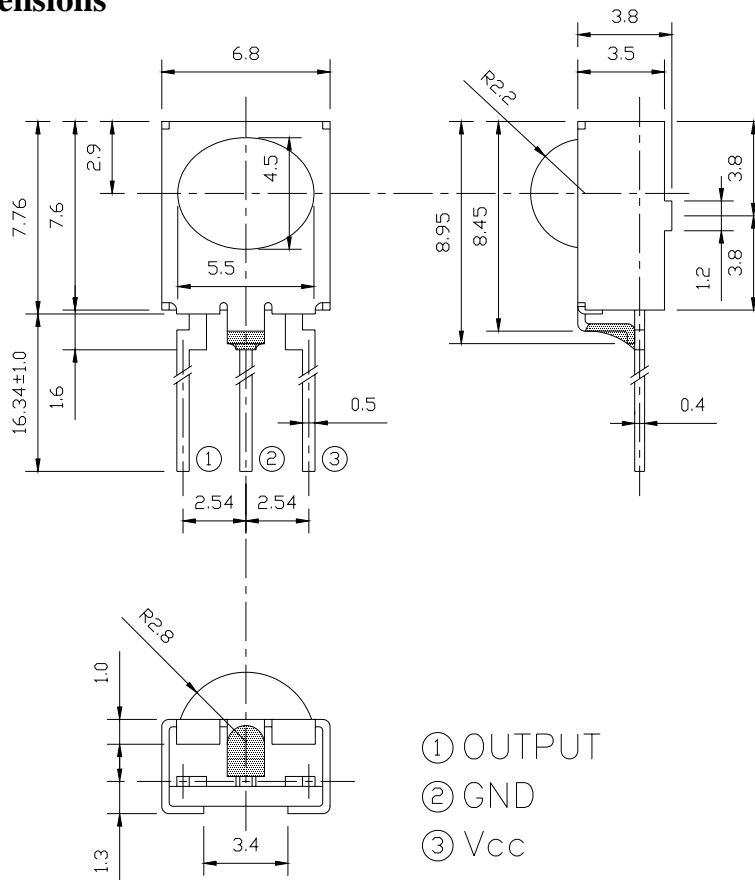

- Notes:** 1.All dimensions are in millimeters.
2.Tolerances unless dimensions $\pm 0.3\text{mm}$.

Absolute Maximum Ratings (Ta=25°C)

Parameter	Symbol	Rating	Unit	Notice
Supply Voltage	Vcc	0~6	V	
Operating Temperature	Topr	-25 ~ +85	°C	
Storage Temperature	Tstg	-40 ~ +85	°C	
Soldering Temperature	Tsol	260	°C	4mm from mold body less than 10 seconds

Recommended Operating Condition
Supply Voltage Rating: Vcc 4.5V to 5.5V
Electro-Optical Characteristics (Ta=25°C, and Vcc=5 V)

Parameter	Symbol	MIN.	TYP.	MAX.	Unit	Condition
Consumption Current	I _{cc}	---	---	3	mA	No signal input
B.P.F Center Frequency	F _o	---	38	---	KHz	
Peak Wavelength	λ_p	---	940	---	nm	
Reception Distance	L ₀	8	---	---	m	At the ray axis *1
	L ₄₅	4	---	---		
Half Angle(Horizontal)	Θ_h	---	45	---	deg	
Half Angle(Vertical)	Θ_v	---	45	---	deg	
High Level Pulse Width	T _H	400	---	800	μs	
Low Level Pulse Width	T _L	400	---	800	μs	
High Level Output Voltage	V _H	4.5	---	---	V	
Low Level Output Voltage	V _L	---	0.2	0.5	V	

Notes:

*1:The ray receiving surface at a vertex and relation to the ray axis in the range of $\theta=0^\circ$ and $\theta=45^\circ$.

*2:A range from 30cm to the arrival distance. Average value of 50 pulses.

Test Method :

The specified electro-optical characteristics is satisfied under the following Conditions at the controllable distance.

① Measurement place

A place that is nothing of extreme light reflected in the room.

② External light

Project the light of ordinary white fluorescent lamps which are not high Frequency lamps and must be less then 10 Lux at the module surface.

($E_e \leq 10\text{Lux}$)

③ Standard transmitter

A transmitter whose output is so adjusted as to $V_o=400\text{mVp-p}$ and the output Wave form shown in Fig.-1. According to the measurement method shown in Fig.-2 the standard transmitter is specified.

However , the infrared photodiode to be used for the transmitter should be $\lambda_p=940\text{nm}, \Delta\lambda=50\text{nm}$. Also, photodiode is used of PD438B($V_r=5\text{V}$).

(Standard light / Light source temperature 2856°K).

④ Measuring system

According to the measuring system shown in Fig.-3

Fig.-1 Transmitter Wave Form

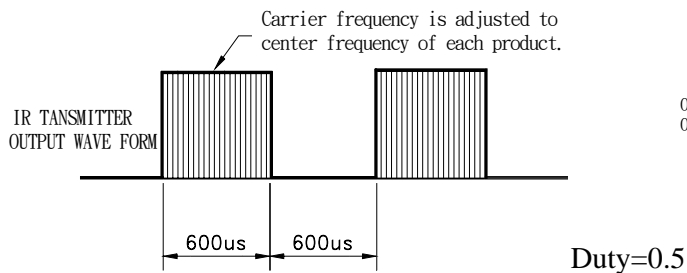

D.U.T output Pulse

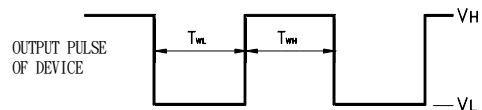

Fig.-2 Measuring Method

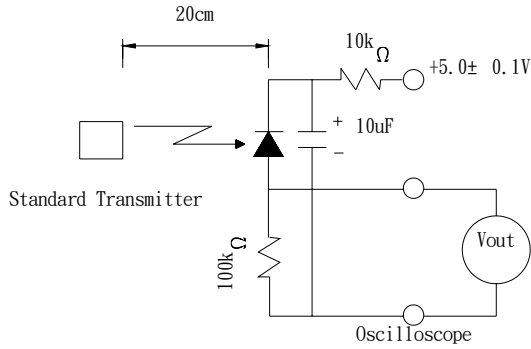
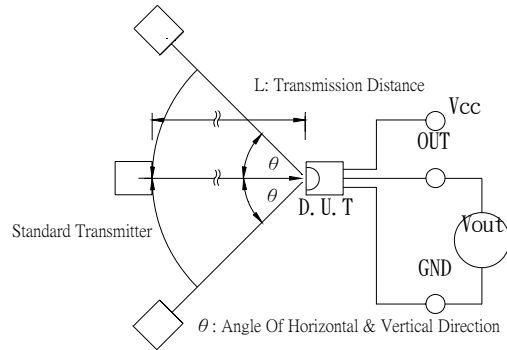
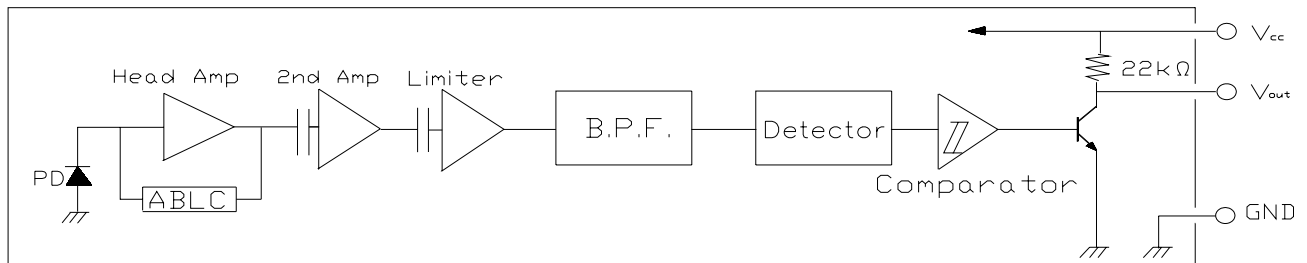

Fig.-3 Measuring System



Block Diagram :



Application Circuit :

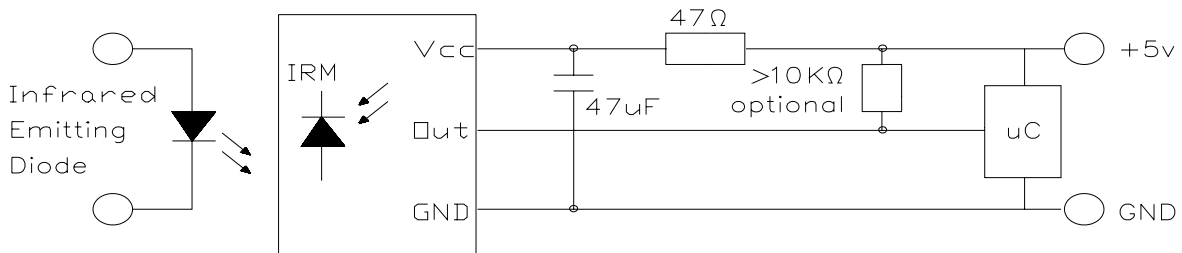

RC Filter should be connected closely between Vcc pin and GND pin.

Typical Electro-Optical Characteristics Curves

Fig.-4 Relative Spectral Sensitivity vs. Wavelength

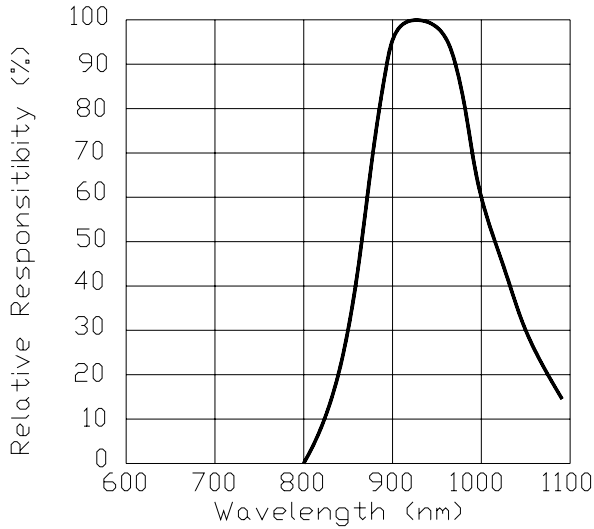

Fig.-5 Relative Transmission Distance vs. Direction

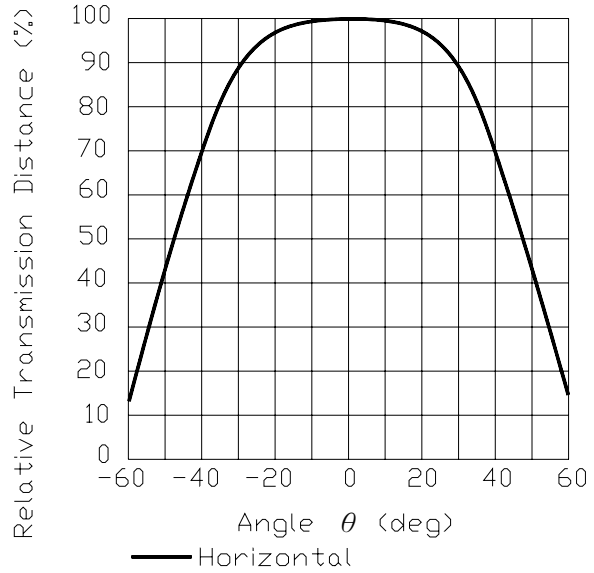

Fig.-6 Output Pulse Length vs. Arrival Distance

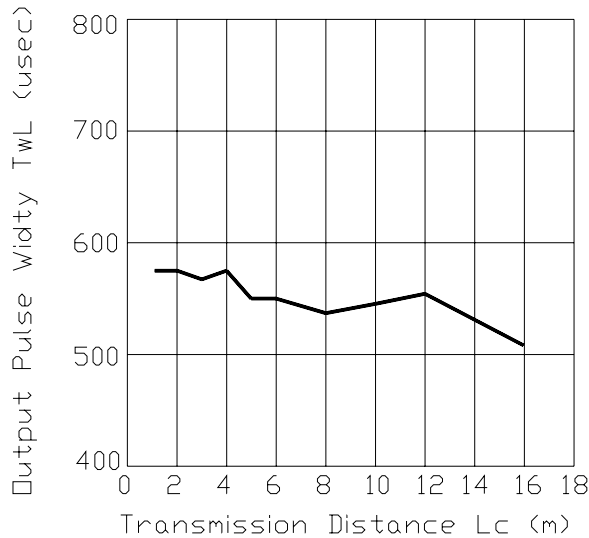
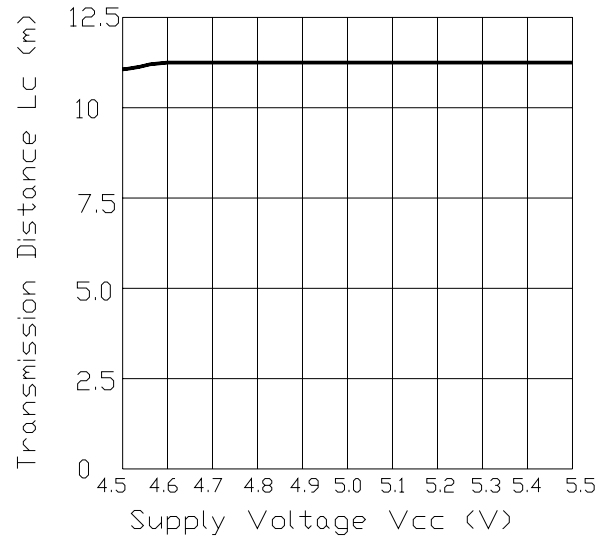

Fig.-7 Arrival Distance vs. Supply Voltage



Typical Electro-Optical Characteristics Curves

Fig.-8 Relative Transmission Distance vs. Center Carrier Frequency

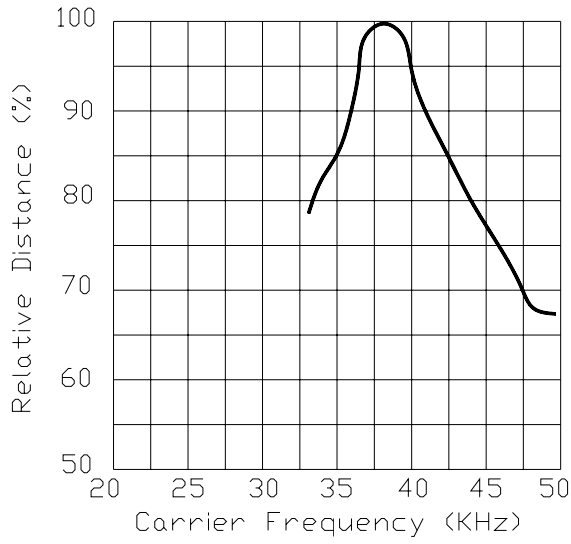
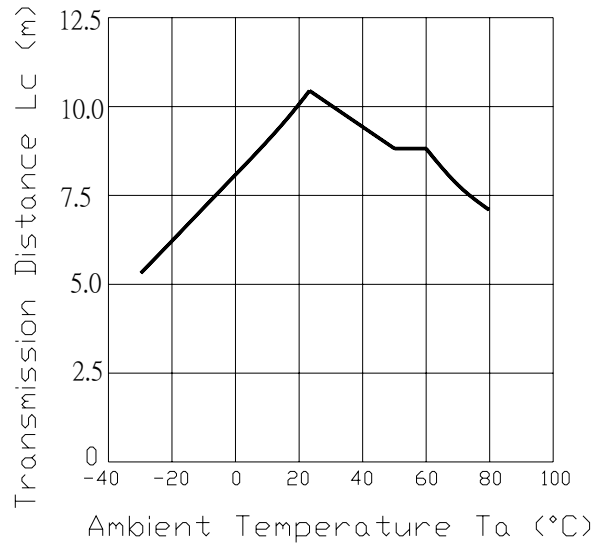

Fig.-9 Arrival Distance vs. Ambient Temperature



**Reliability Test Item And Condition**

The reliability of products shall be satisfied with items listed below.

Confidence level : 90%

LTPD : 10%

Test Items	Test Conditions	Failure Judgement Criteria	Samples(n) Defective(c)
Temperature cycle	1 cycle $-25^{\circ}\text{C} \longleftrightarrow +85^{\circ}\text{C}$ (30min)(5min)(30min) 300 cycle test	$L_0 \leq L \times 0.8$ $L_{45} \leq L \times 0.8$ L: Lower specification limit	n=22,c=0
High temperature test	Temp: $+85^{\circ}\text{C}$ Vcc:5V 1000hrs		n=22,c=0
Low temperature storage	Temp: -40°C 1000hrs		n=22,c=0
High temperature High humidity	Ta: 85°C ,RH:85% 1000hrs		n=22,c=0
Solder heat	Temp: $260 \pm 5^{\circ}\text{C}$ 10sec 4mm From the bottom of the package.		n=22,c=0



Packing Quantity Specification

1. 1000 PCS/1Box
2. 10 Boxes/1Carton

Label Form Specification

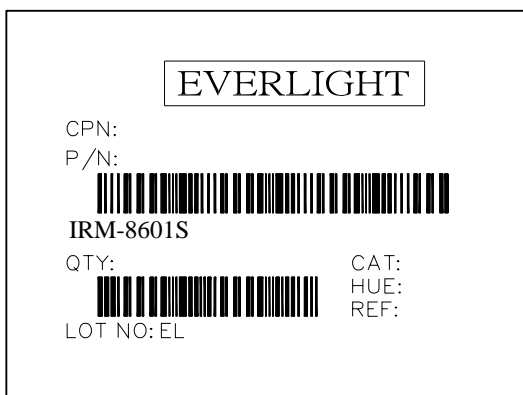

CPN: Customer's Production Number

P/N : Production Number

QTY: Packing Quantity

CAT: Ranks

HUE: Peak Wavelength

REF: Reference

LOT No: Lot Number

Notes

1. Above specification may be changed without notice. EVERLIGHT will reserve authority on material change for above specification.
2. When using this product, please observe the absolute maximum ratings and the instructions for using outlined in these specification sheets. EVERLIGHT assumes no responsibility for any damage resulting from use of the product which does not comply with the absolute maximum ratings and the instructions included in these specification sheets.
3. These specification sheets include materials protected under copyright of EVERLIGHT corporation. Please don't reproduce or cause anyone to reproduce them without EVERLIGHT's consent.

EVERLIGHT ELECTRONICS CO., LTD.

Office: No 25, Lane 76, Sec 3, Chung Yang Rd,
Tucheng, Taipei 236, Taiwan, R.O.C

Tel: 886-2-2267-2000, 2267-9936

Fax: 886-2267-6244, 2267-6189, 2267-6306

<http://www.everlight.com>