



LIGITEK

LIGITEK ELECTRONICS CO.,LTD.  
Property of Ligitek Only

---

SURFACE MOUNT LED TAPE AND REEL



Lead-Free Parts

**LSIR9033/TR1**

DATA SHEET

DOC. NO : QW0905-L SIR9033/TR1

REV. : E

DATE : 26 - Dec - 2005



### Package Dimensions

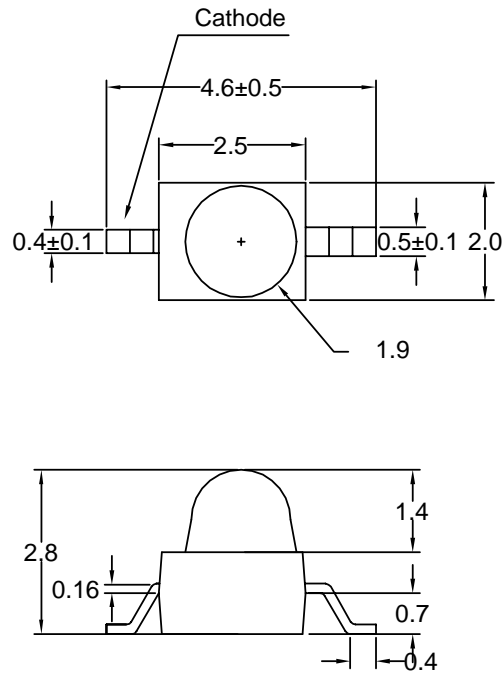

Note : 1.All dimension are in millimeter tolerance is ±0.2mm unless otherwise noted.  
2.Specifications are subject to change without notice.

### Carrier Type Dimensions

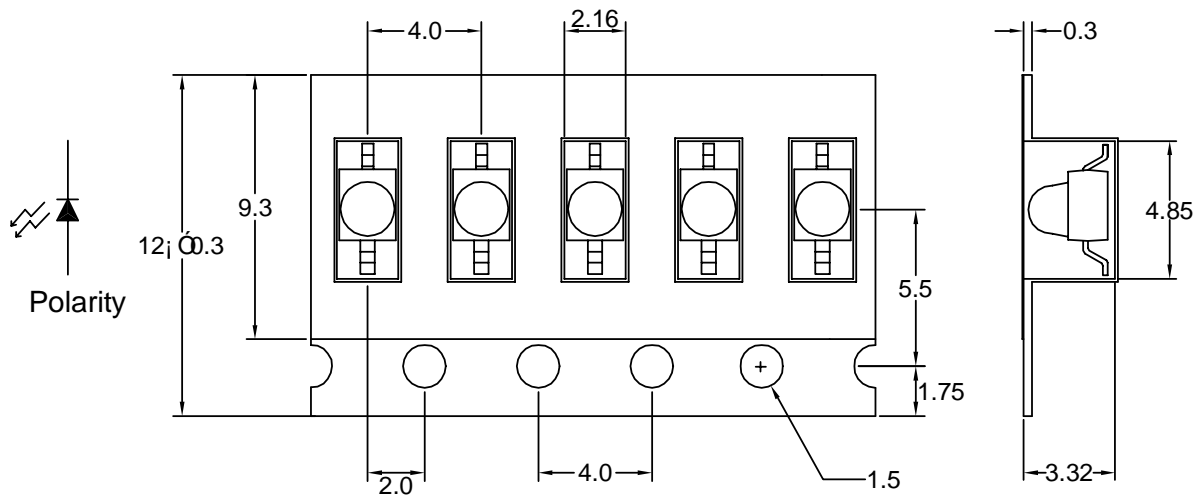

Note : The tolerances unless mentioned is ±0.2mm, Angle ± 0.5. Unit=mm.



### Reel Dimensions

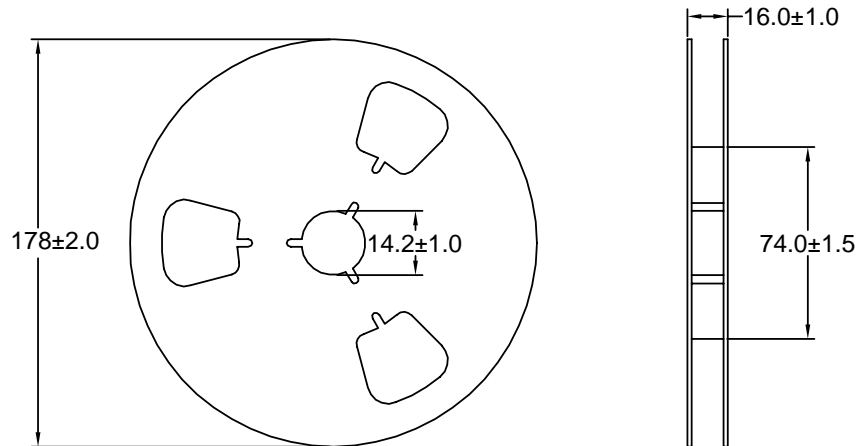

Description	Quantity/Reel
12.0mm tape, 7" reel	1500 devices

### Features:

1. High radiant intensity.
2. Suitable for pulsed applications.
3. Low average degradation.

### Descriptions:

The LSIR9033/TR1 series are super-high efficiency Gallium Aluminum Arsenide infrared emitting diodes encapsulated in water clear plastic T-1 3/4 package individually

### Device Selection Guide:

PART NO	MATERIAL	LENS COLOR
LSIR9033/TR1	GaAlAs	Water Clear



**Absolute Maximum Ratings at Ta=25**

Parameter	Symbol	Ratings	UNIT
		SIR	
Power Dissipation	PD	100	mW
Peak Forward Current (300PPS,1 μ s Pulse)	IFP	1	A
Forward Current	IF	50	mA
Reverse Voltage	Vr	5	V
Electrostatic Discharge	ESD	2000	V
Operating Temperature	Topr	-55 ~ +100	
Storage Temperature	Tstg	-55 ~ +100	
Soldering Temperature	Tsol	Max 260 for 5 sec Max (2mm from body)	

**Electrical Optical Characteristics (Aa=25 )**

PARAMETER	SYMBOL	Min.	Typ.	Max.	UNIT	TEST CONDITION
Radiant Intensity	Le	1.2	2.0		mW/sr	IF=20mA
Aperture Radiant Incidence	Ee	0.15	0.3		mW/cm <sup>2</sup>	IF=20mA
Peak Emission Wavelength	peak		880		nm	IF=20mA
Spectral Line Half Width			70		nm	IF=20mA
Forward Voltage	VF		1.4	1.7	V	IF=20mA
Reverse Current	IR			100	μ A	VR=5V
Viewing Angle	2 1/2		20		deg	

Note : 1.The forward voltage data did not including ±0.1V testing tolerance.  
2. The radiant intensity data did not including ±15% testing tolerance.



### Typical Electro-Optical Characteristics Curve

SIR CHIP

Fig.1 Forward Current vs. Forward Voltage

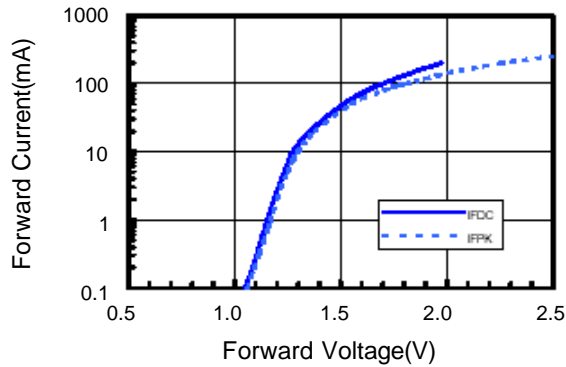

Fig.2 Relative Radiant Intensity vs. Wavelength

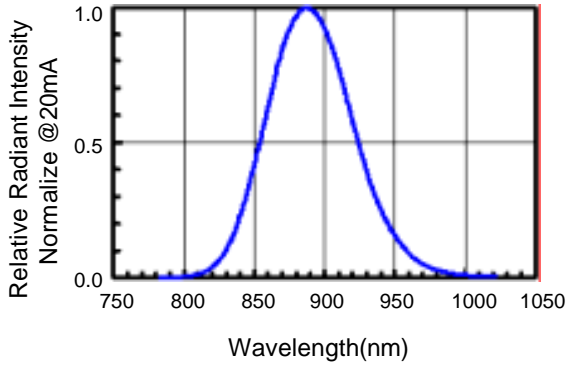

Fig.3 Relative Radiant Power vs. Forward DC Current

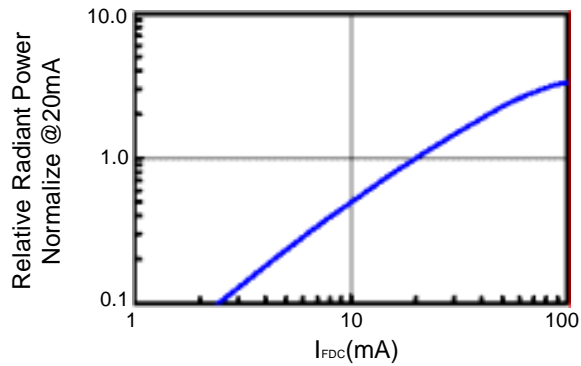

Fig.4 Relative Radiant Power vs. Forward Peak Current

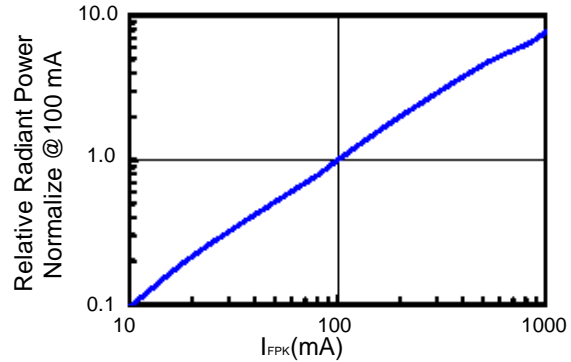

Fig.5 Forward DC Voltage vs. Temperature

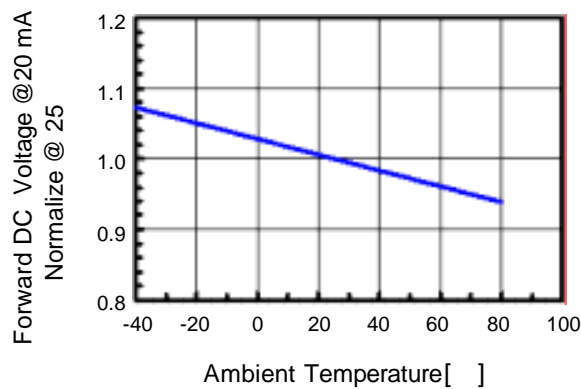
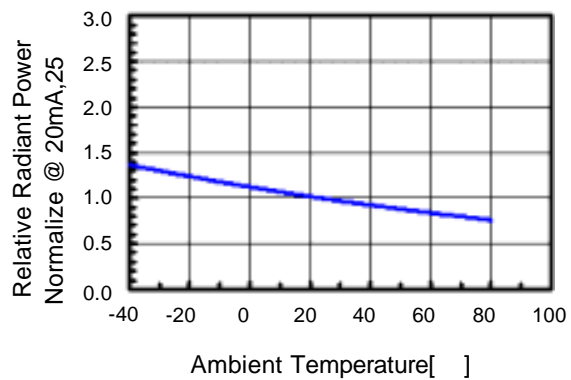

Fig.6 Relative Radiant Power vs. Temperature





Recommended Soldering Conditions

1. Hand Solder

Basic spec is 280 3 sec one time only.

2. Wave Solder

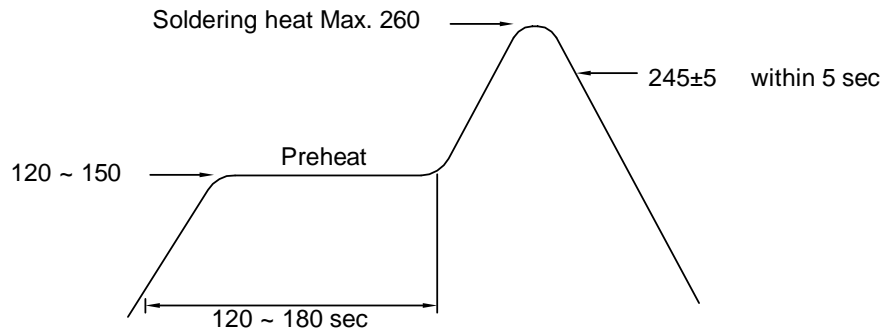

3-1. LEAD Reflow Solder

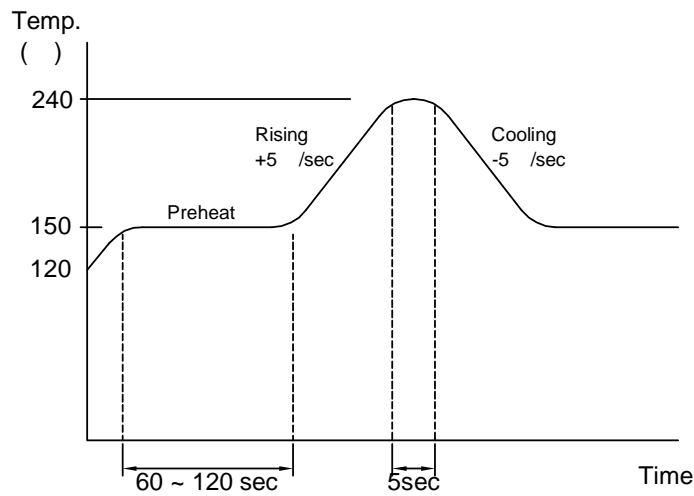

3-2 PB-Free Reflow Solder

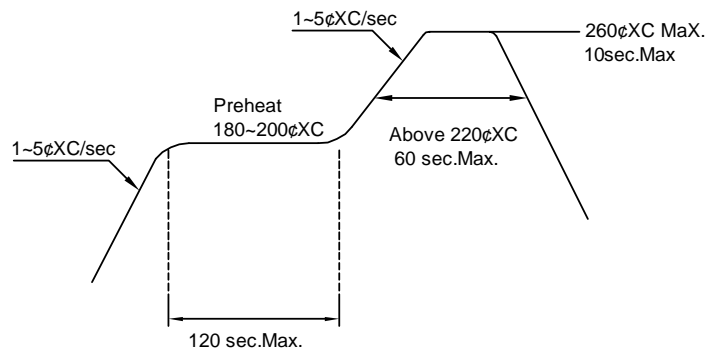

Reflow Soldering should not be done more than two times.



Precautions For Use:

Storage time:

- 1.The operation of Temperatures and RH are : 5 ~35 ,RH60%.
- 2.Once the package is opened, the products should be used within a week. Otherwise, they should be kept in a damp proof box with descanting agent. Considering the tape life, we suggest our customers to use our products within a year(from production date).
- 3.If opened more than one week in an atmosphere 5 ~ 35 ,RH60%, they should be treated at 60 ±5 for 15hrs.

Drive Method:

LED is a current operated device, and therefore, requires some kind of current limiting incorporated into the driver circuit. This current limiting typically takes the form of a current limiting resistor placed in series with the LED.

Consider worst case voltage variations that could occur across the current limiting resistor. The forward current should not be allowed to change by more than 40 % of its desired value.

Circuit model A

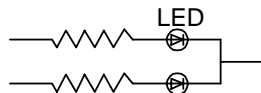

Circuit model B

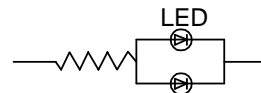

(A) Recommended circuit.

(B) The difference of brightness between LED could be found due to the VF-IF characteristics of LED.

Cleaning:

Use alcohol-based cleaning solvents such as isopropyl alcohol to clean the LED.

ESD(Electrostatic Discharge):

Static Electricity or power surge will damage the LED. Use of a conductive wrist band or anti-electrostatic glove is recommended when handling these LED. All devices, equipment and machinery must be properly grounded.



Reliability Test:

Test Item	Test Condition	Description	Reference Standard
Operating Life Test	1.Under Room Temperature 2.If=20mA 3.t=1000 hrs (-24hrs, +72hrs)	This test is conducted for the purpose of determining the resistance of a part in electrical and thermal stressed.	MIL-STD-750: 1026 MIL-STD-883: 1005 JIS C 7021: B-1
High Temperature Storage Test	1.Ta=105 ±5 2.t=1000 hrs (-24hrs, +72hrs)	The purpose of this is the resistance of the device which is laid under condition of high temperature for hours.	MIL-STD-883:1008 JIS C 7021: B-10
Low Temperature Storage Test	1.Ta=-40 ±5 2.t=1000 hrs (-24hrs, +72hrs)	The purpose of this is the resistance of the device which is laid under condition of low temperature for hours.	JIS C 7021: B-12
High Temperature High Humidity Test	1.Ta=65 ±5 2.RH=90%~95% 3.t=240hrs ±2hrs	The purpose of this test is the resistance of the device under tropical for hours.	MIL-STD-202:103B JIS C 7021: B-11
Thermal Shock Test	1.Ta=105 ±5 & -40 ±5 (10min) (10min) 2.total 10 cycles	The purpose of this is the resistance of the device to sudden extreme changes in high and low temperature.	MIL-STD-202: 107D MIL-STD-750: 1051 MIL-STD-883: 1011
Solder Resistance Test	1.T.Sol=260 ±5 2.Dwell time= 10 ±1sec.	This test intended to determine the thermal characteristic resistance of the device to sudden exposures at extreme changes in temperature when soldering the lead wire.	MIL-STD-202: 210A MIL-STD-750: 2031 JIS C 7021: A-1
Solderability Test	1.T.Sol=230 ±5 2.Dwell time=5 ±1sec	This test intended to see soldering well performed or not.	MIL-STD-202: 208D MIL-STD-750: 2026 MIL-STD-883: 2003 JIS C 7021: A-2