

128K x 8 Static RAM

Features

- **High speed**
— $t_{AA} = 10 \text{ ns}$
- **Low active power**
— 1017 mW (max., 12 ns)
- **Low CMOS standby power**
— 55 mW (max.), 4 mW (Low power version)
- **2.0V Data Retention (Low power version)**
- **Automatic power-down when deselected**
- **TTL-compatible inputs and outputs**
- **Easy memory expansion with \overline{CE}_1 , \overline{CE}_2 , and \overline{OE} options**

Functional Description

The CY7C109 / CY7C1009 is a high-performance CMOS static RAM organized as 131,072 words by 8 bits. Easy memory expansion is provided by an active LOW chip enable (\overline{CE}_1), an

active HIGH chip enable (\overline{CE}_2), an active LOW output enable (\overline{OE}), and three-state drivers. Writing to the device is accomplished by taking chip enable one (\overline{CE}_1) and write enable (\overline{WE}) inputs LOW and chip enable two (\overline{CE}_2) input HIGH. Data on the eight I/O pins (I/O_0 through I/O_7) is then written into the location specified on the address pins (A_0 through A_{16}).

Reading from the device is accomplished by taking chip enable one (\overline{CE}_1) and output enable (\overline{OE}) LOW while forcing write enable (\overline{WE}) and chip enable two (\overline{CE}_2) HIGH. Under these conditions, the contents of the memory location specified by the address pins will appear on the I/O pins.

The eight input/output pins (I/O_0 through I/O_7) are placed in a high-impedance state when the device is deselected (\overline{CE}_1 HIGH or \overline{CE}_2 LOW), the outputs are disabled (\overline{OE} HIGH), or during a write operation (\overline{CE}_1 LOW, \overline{CE}_2 HIGH, and \overline{WE} LOW).

The CY7C109 is available in standard 400-mil-wide SOJ and 32-pin TSOP type I packages. The CY7C1009 is available in a 300-mil-wide SOJ package. The CY7C1009 and CY7C109 are functionally equivalent in all other respects.

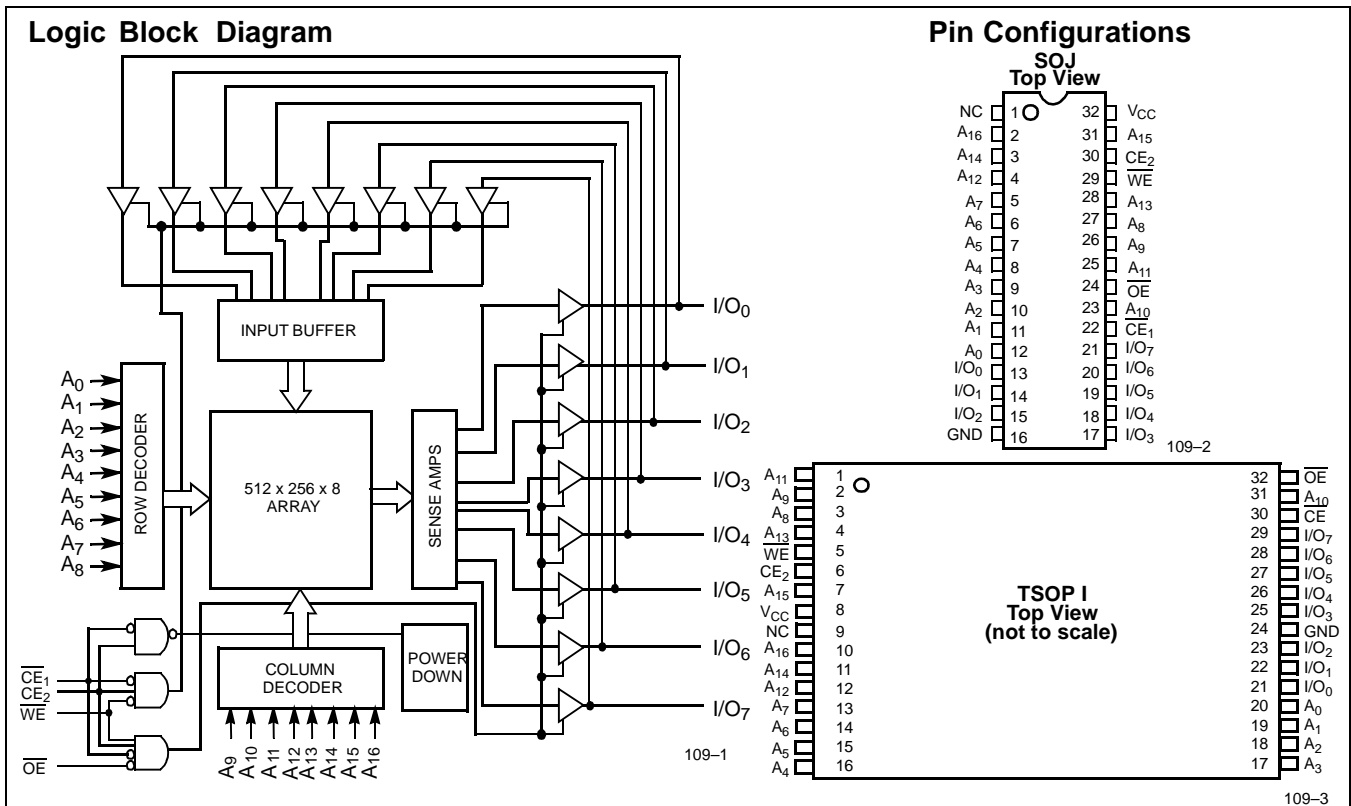

Selection Guide

	7C109-10 7C1009-10	7C109-12 7C1009-12	7C109-15 7C1009-15	7C109-20 7C1009-20	7C109-25 7C1009-25	7C109-35 7C1009-35
Maximum Access Time (ns)	10	12	15	20	25	35
Maximum Operating Current (mA)	195	185	155	140	135	125
Maximum CMOS Standby Current (mA)	10	10	10	10	10	10
Maximum CMOS Standby Current (mA) Low Power Version	2	2	2	—	—	—

Shaded areas contain preliminary information.

Maximum Ratings

(Above which the useful life may be impaired. For user guidelines, not tested.)

Storage Temperature -65°C to +150°C
 Ambient Temperature with Power Applied..... -55°C to +125°C
 Supply Voltage on V_{CC} to Relative GND^[1] -0.5V to +7.0V
 DC Voltage Applied to Outputs in High Z State^[1] -0.5V to V_{CC} + 0.5V
 DC Input Voltage^[1] -0.5V to V_{CC} + 0.5V
 Current into Outputs (LOW) 20 mA

Static Discharge Voltage >2001V
 (per MIL-STD-883, Method 3015)

Latch-Up Current >200 mA

Operating Range

Range	Ambient Temperature ^[2]	V _{CC}
Commercial	0°C to +70°C	5V ± 10%
Industrial	-40°C to +85°C	5V ± 10%

Electrical Characteristics Over the Operating Range^[3]

Parameter	Description	Test Conditions	7C109-10 7C1009-10		7C109-12 7C1009-12		7C109-15 7C1009-15		Unit
			Min.	Max.	Min.	Max.	Min.	Max.	
V _{OH}	Output HIGH Voltage	V _{CC} = Min., I _{OH} = -4.0 mA	2.4		2.4		2.4		V
V _{OL}	Output LOW Voltage	V _{CC} = Min., I _{OL} = 8.0 mA		0.4		0.4		0.4	V
V _{IH}	Input HIGH Voltage		2.2	V _{CC} + 0.3	2.2	V _{CC} + 0.3	2.2	V _{CC} + 0.3	V
V _{IL}	Input LOW Voltage ^[1]		-0.3	0.8	-0.3	0.8	-0.3	0.8	V
I _{Ix}	Input Load Current	GND ≤ V _I ≤ V _{CC}	-1	+1	-1	+1	-1	+1	μA
I _{OZ}	Output Leakage Current	GND ≤ V _I ≤ V _{CC} , Output Disabled	-5	+5	-5	+5	-5	+5	μA
I _{OS}	Output Short Circuit Current ^[3]	V _{CC} = Max., V _{OUT} = GND		-300		-300		-300	mA
I _{CC}	V _{CC} Operating Supply Current	V _{CC} = Max., I _{OUT} = 0 mA, f = f _{MAX} = 1/t _{RC}		195		185		155	mA
I _{SB1}	Automatic CE Power-Down Current —TTL Inputs	Max. V _{CC} , $\overline{CE}_1 \geq V_{IH}$ or CE ₂ ≤ V _{IL} , V _{IN} ≥ V _{IH} or V _{IN} ≤ V _{IL} , f = f _{MAX}		45		45		40	mA
I _{SB2}	Automatic CE Power-Down Current —CMOS Inputs	Max. V _{CC} , CE ₁ ≥ V _{CC} - 0.3V, or CE ₂ ≤ 0.3V, V _{IN} ≥ V _{CC} - 0.3V, or V _{IN} ≤ 0.3V, f=0		10		10		10	mA
			L	2		2		2	

Shaded areas contain preliminary information.

Electrical Characteristics Over the Operating Range (continued)

Parameter	Description	Test Conditions	7C109-20 7C1009-20		7C109-25 7C1009-25		7C109-35 7C1009-35		Unit
			Min.	Max.	Min.	Max.	Min.	Max.	
V_{OH}	Output HIGH Voltage	$V_{CC} = \text{Min.}$, $I_{OH} = -4.0 \text{ mA}$	2.4		2.4		2.4		V
V_{OL}	Output LOW Voltage	$V_{CC} = \text{Min.}$, $I_{OL} = 8.0 \text{ mA}$		0.4		0.4		0.4	V
V_{IH}	Input HIGH Voltage		2.2	$V_{CC} + 0.3$	2.2	$V_{CC} + 0.3$	2.2	$V_{CC} + 0.3$	V
V_{IL}	Input LOW Voltage ^[1]		-0.3	0.8	-0.3	0.8	-0.3	0.8	V
I_{IX}	Input Load Current	$GND \leq V_I \leq V_{CC}$	-1	+1	-1	+1	-1	+1	μA
I_{OZ}	Output Leakage Current	$GND \leq V_I \leq V_{CC}$, Output Disabled	-5	+5	-5	+5	-5	+5	μA
I_{OS}	Output Short Circuit Current ^[3]	$V_{CC} = \text{Max.}$, $V_{OUT} = GND$		-300		-300		-300	mA
I_{CC}	V_{CC} Operating Supply Current	$V_{CC} = \text{Max.}$, $I_{OUT} = 0 \text{ mA}$, $f = f_{MAX} = 1/t_{RC}$		140		135		125	mA
I_{SB1}	Automatic CE Power-Down Current —TTL Inputs	Max. V_{CC} , $CE_1 \geq V_{IH}$ or $CE_2 \leq V_{IL}$, $V_{IN} \geq V_{IH}$ or $V_{IN} \leq V_{IL}$, $f = f_{MAX}$		30		30		25	mA
I_{SB2}	Automatic CE Power-Down Current —CMOS Inputs	Max. V_{CC} , $CE_1 \geq V_{CC} - 0.3\text{V}$, or $CE_2 \leq 0.3\text{V}$, $V_{IN} \geq V_{CC} - 0.3\text{V}$, or $V_{IN} \leq 0.3\text{V}$, $f=0$		10		10		10	mA

Capacitance^[4]

Parameter	Description	Test Conditions	Max.	Unit
C_{IN}	Input Capacitance	$T_A = 25^\circ\text{C}$, $f = 1 \text{ MHz}$, $V_{CC} = 5.0\text{V}$	9	pF
C_{OUT}	Output Capacitance		8	pF

Notes:

- $V_{IL}(\text{min.}) = -2.0\text{V}$ for pulse durations of less than 20 ns.
- T_A is the "instant on" case temperature.
- Not more than one output should be shorted at one time. Duration of the short circuit should not exceed 30 seconds.
- Tested initially and after any design or process changes that may affect these parameters.

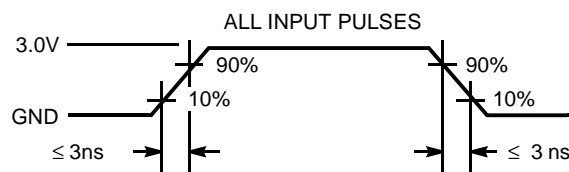
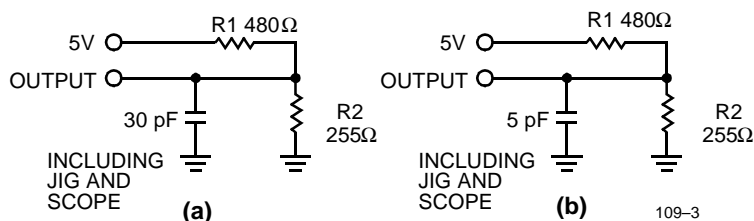
AC Test Loads and Waveforms

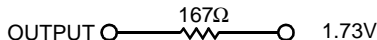
Equivalent to: THÉVENIN EQUIVALENT

109-4

Switching Characteristics^[3,5] Over the Operating Range

Parameter	Description	7C109-10 7C1009-10		7C109-12 7C1009-12		7C109-15 7C1009-15		Unit
		Min.	Max.	Min.	Max.	Min.	Max.	
READ CYCLE								
t_{RC}	Read Cycle Time	10		12		15		ns
t_{AA}	Address to Data Valid		10		12		15	ns
t_{OHA}	Data Hold from Address Change	3		3		3		ns
t_{ACE}	\overline{CE}_1 LOW to Data Valid, CE_2 HIGH to Data Valid		10		12		15	ns
t_{DOE}	\overline{OE} LOW to Data Valid		5		6		7	ns
t_{LZOE}	\overline{OE} LOW to Low Z	0		0		0		ns
t_{HZOE}	\overline{OE} HIGH to High Z ^[6,7]		5		6		7	ns
t_{LZCE}	\overline{CE}_1 LOW to Low Z, CE_2 HIGH to Low Z ^[7]	3		3		3		ns
t_{HZCE}	\overline{CE}_1 HIGH to High Z, CE_2 LOW to High Z ^[6,7]		5		6		7	ns
t_{PU}	\overline{CE}_1 LOW to Power-Up, CE_2 HIGH to Power-Up	0		0		0		ns
t_{PD}	\overline{CE}_1 HIGH to Power-Down, CE_2 LOW to Power-Down		10		12		15	ns
WRITE CYCLE^[8,9]								
t_{WC}	Write Cycle Time	10		12		15		ns
t_{SCE}	\overline{CE}_1 LOW to Write End, CE_2 HIGH to Write End	8		10		12		ns
t_{AW}	Address Set-Up to Write End	8		10		12		ns
t_{HA}	Address Hold from Write End	0		0		0		ns
t_{SA}	Address Set-Up to Write Start	0		0		0		ns
t_{PWE}	\overline{WE} Pulse Width	8		10		12		ns
t_{SD}	Data Set-Up to Write End	6		7		8		ns
t_{HD}	Data Hold from Write End	0		0		0		ns
t_{LZWE}	\overline{WE} HIGH to Low Z ^[7]	3		3		3		ns
t_{HZWE}	\overline{WE} LOW to High Z ^[6,7]		5		6		7	ns

Shaded areas contain preliminary information.

Notes:

- Test conditions assume signal transition time of 3 ns or less, timing reference levels of 1.5V, input pulse levels of 0 to 3.0V, and output loading of the specified I_{OL}/I_{OH} and 30-pF load capacitance.
- t_{HZOE} , t_{HZCE} , and t_{HZWE} are specified with a load capacitance of 5 pF as in part (b) of AC Test Loads. Transition is measured ± 500 mV from steady-state voltage.
- At any given temperature and voltage condition, t_{HZCE} is less than t_{LZCE} , t_{HZOE} is less than t_{LZOE} , and t_{HZWE} is less than t_{LZWE} for any given device.
- The internal write time of the memory is defined by the overlap of \overline{CE}_1 LOW, CE_2 HIGH, and \overline{WE} LOW. \overline{CE}_1 and \overline{WE} must be LOW and CE_2 HIGH to initiate a write, and the transition of any of these signals can terminate the write. The input data set-up and hold timing should be referenced to the leading edge of the signal that terminates the write.
- The minimum write cycle time for Write Cycle no. 3 (\overline{WE} controlled, \overline{OE} LOW) is the sum of t_{HZWE} and T_{SD} .

Switching Characteristics^[3, 5] Over the Operating Range

Parameter	Description	7C109-20 7C1009-20		7C109-25 7C1009-25		7C109-35 7C1009-35		Unit
		Min.	Max.	Min.	Max.	Min.	Min.	
READ CYCLE								
t_{RC}	Read Cycle Time	20		25		35		ns
t_{AA}	Address to Data Valid		20		25		35	ns
t_{OHA}	Data Hold from Address Change	3		5		5		ns
t_{ACE}	\overline{CE}_1 LOW to Data Valid, CE_2 HIGH to Data Valid		20		25		35	ns
t_{DOE}	\overline{OE} LOW to Data Valid		8		10		15	ns
t_{LZOE}	\overline{OE} LOW to Low Z	0		0		0		ns
t_{HZOE}	\overline{OE} HIGH to High Z ^[6, 7]		8		10		15	ns
t_{LZCE}	\overline{CE}_1 LOW to Low Z, CE_2 HIGH to Low Z ^[7]	3		5		5		ns
t_{HZCE}	\overline{CE}_1 HIGH to High Z, CE_2 LOW to High Z ^[6, 7]		8		10		15	ns
t_{PU}	\overline{CE}_1 LOW to Power-Up, CE_2 HIGH to Power-Up	0		0		0		ns
t_{PD}	\overline{CE}_1 HIGH to Power-Down, CE_2 LOW to Power-Down		20		25		35	ns
WRITE CYCLE^[8]								
t_{WC}	Write Cycle Time	20		25		35		ns
t_{SCE}	\overline{CE}_1 LOW to Write End, CE_2 HIGH to Write End	15		20		25		ns
t_{AW}	Address Set-Up to Write End	15		20		25		ns
t_{HA}	Address Hold from Write End	0		0		0		ns
t_{SA}	Address Set-Up to Write Start	0		0		0		ns
t_{PWE}	\overline{WE} Pulse Width	12		15		20		ns
t_{SD}	Data Set-Up to Write End	10		15		20		ns
t_{HD}	Data Hold from Write End	0		0		0		ns
t_{LZWE}	\overline{WE} HIGH to Low Z ^[7]	3		5		5		ns
t_{HZWE}	\overline{WE} LOW to High Z ^[6, 7]		8		10		15	ns

Data Retention Characteristics Over the Operating Range (L Version Only)

Parameter	Description	Conditions	Min.	Max	Unit
V_{DR}	V_{CC} for Data Retention	No input may exceed $V_{CC} + 0.5V$ $V_{CC} = V_{DR} = 2.0V$, $CE_1 \geq V_{CC} - 0.3V$ or $CE_2 \leq 0.3V$, $V_{IN} \geq V_{CC} - 0.3V$ or $V_{IN} \leq 0.3V$	2.0		V
I_{CCDR}	Data Retention Current			50	μA
t_{CDR}	Chip Deselect to Data Retention Time		0		ns
t_R	Operation Recovery Time		t_{RC}		ns

Shaded areas contain preliminary information.

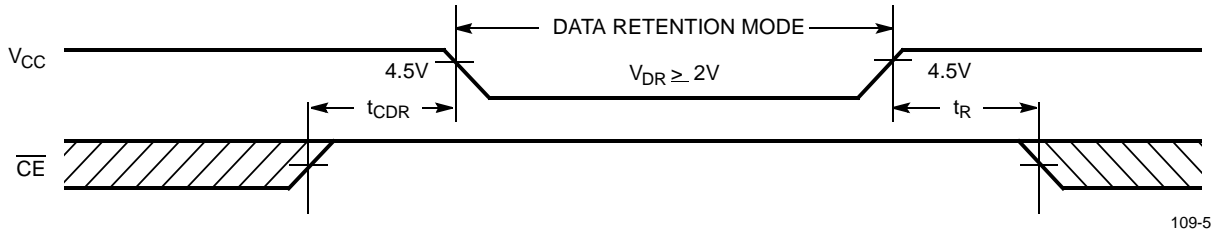
Data Retention Waveform

109-5

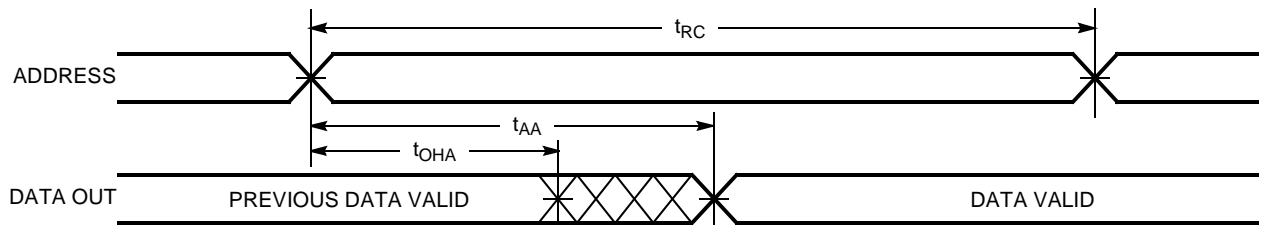
Switching Waveforms
Read Cycle No. 1^[10, 11]

109-6

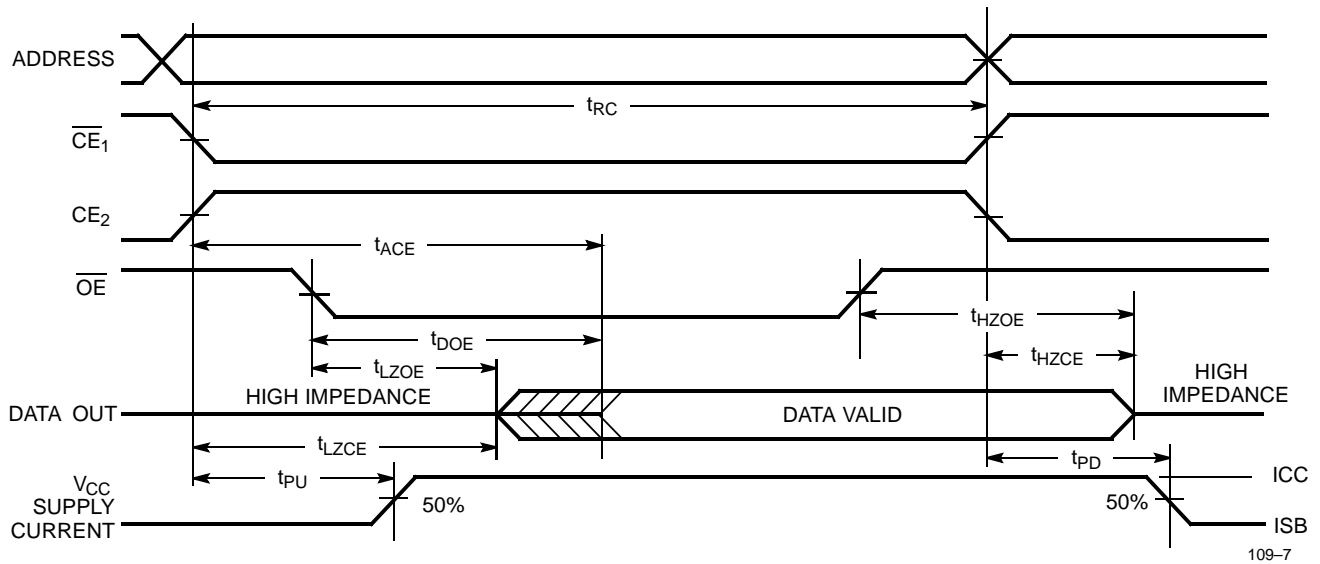
Read Cycle No. 2 (\overline{OE} Controlled)^[11, 12]

109-7

Notes:

10. Device is continuously selected. \overline{OE} , $\overline{CE}_1 = V_{IL}$, $CE_2 = V_{IH}$.
11. \overline{WE} is HIGH for read cycle.
12. Address valid prior to or coincident with \overline{CE}_1 transition LOW and CE_2 transition HIGH.

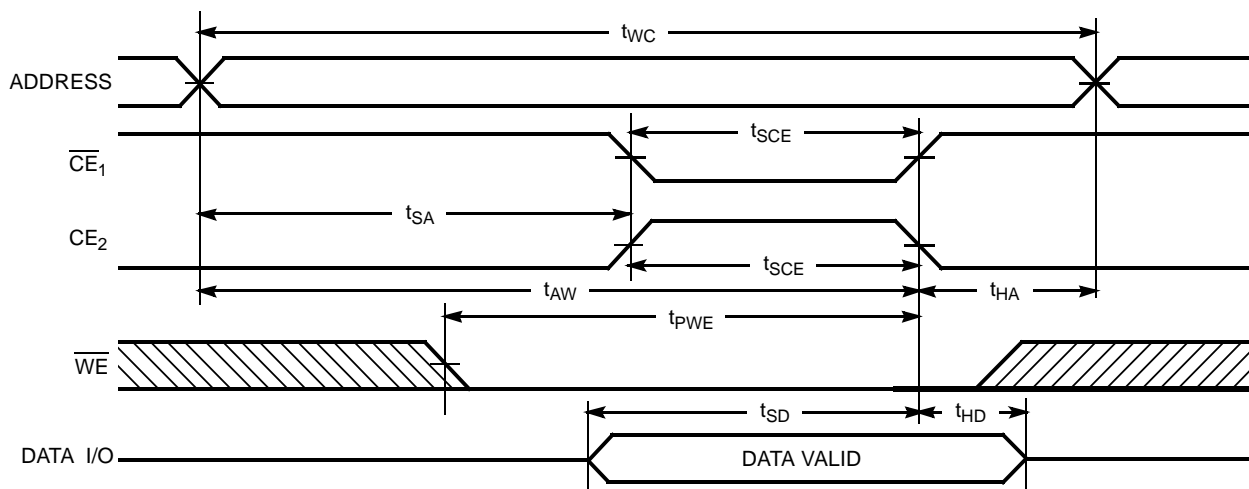
Switching Waveforms (continued)
Write Cycle No. 1 (\overline{CE}_1 or CE_2 Controlled)^[13, 14]

109-8

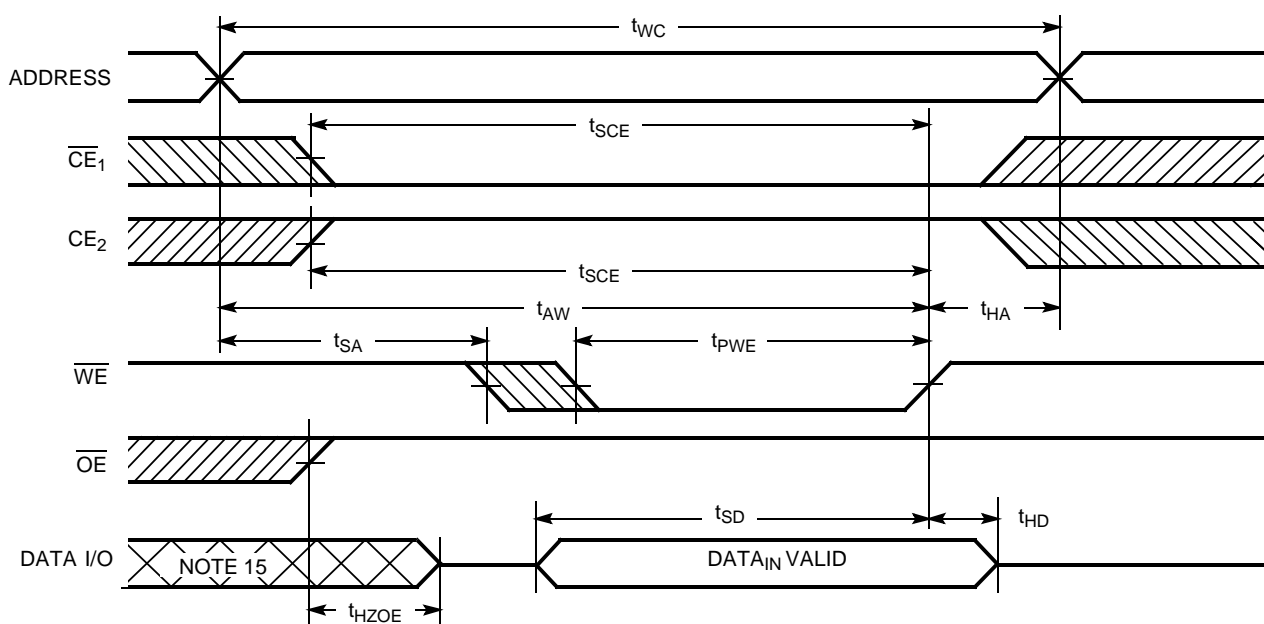
Write Cycle No. 2 (\overline{WE} Controlled, \overline{OE} HIGH During Write)^[13, 14]

109-9

Notes:

13. Data I/O is high impedance if $\overline{OE} = V_{IH}$.
 14. If \overline{CE}_1 goes HIGH or CE_2 goes LOW simultaneously with \overline{WE} going HIGH, the output remains in a high-impedance state.

Switching Waveforms (continued)

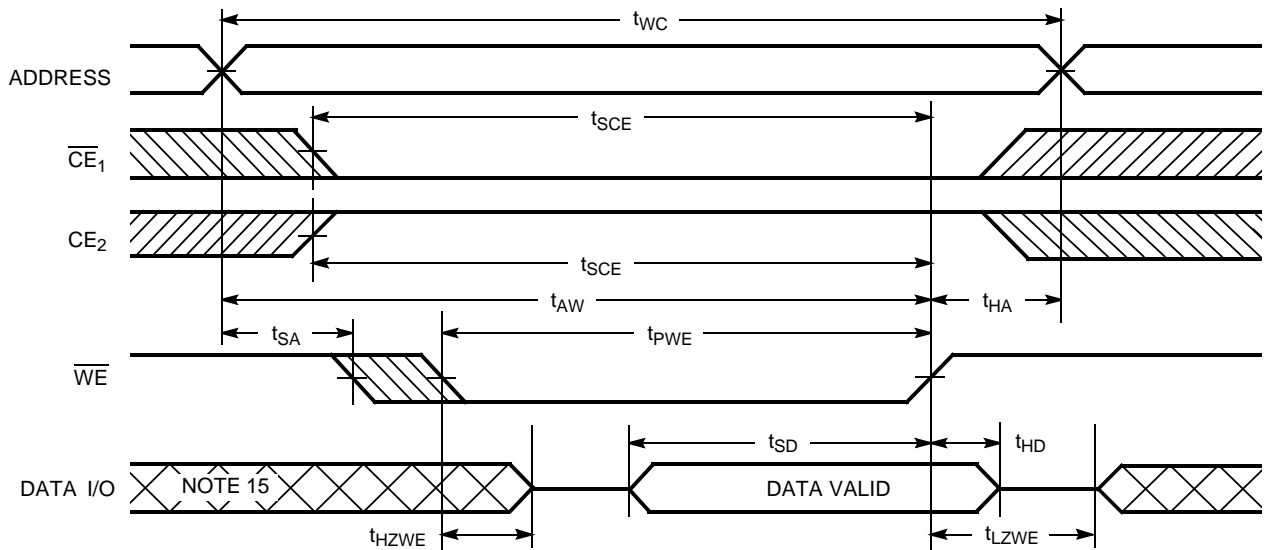
Write Cycle No. 3 (\overline{WE} Controlled, \overline{OE} LOW)^[14]

109-9

Note:

15. During this period the I/Os are in the output state and input signals should not be applied.

Truth Table

\overline{CE}_1	\overline{CE}_2	\overline{OE}	\overline{WE}	I/O ₀ - I/O ₇	Mode	Power
H	X	X	X	High Z	Power-Down	Standby (I_{SB})
X	L	X	X	High Z	Power-Down	Standby (I_{SB})
L	H	L	H	Data Out	Read	Active (I_{CC})
L	H	X	L	Data In	Write	Active (I_{CC})
L	H	H	H	High Z	Selected, Outputs Disabled	Active (I_{CC})

Ordering Information

Speed (ns)	Ordering Code	Package Name	Package Type	Operating Range	
10	CY7C109-10VC	V33	32-Lead (400-Mil) Molded SOJ	Commercial	
	CY7C1009-10VC	V32	32-Lead (300-Mil) Molded SOJ		
	CY7C1009L-10VC	V32	32-Lead (300-Mil) Molded SOJ		
12	CY7C109-12VC	V33	32-Lead (400-Mil) Molded SOJ		
	CY7C1009-12VC	V32	32-Lead (300-Mil) Molded SOJ		
	CY7C1009L-12VC	V32	32-Lead (300-Mil) Molded SOJ		
	CY7C109-12ZC	Z32	32-Lead TSOP Type I		
15	CY7C109-15VC	V33	32-Lead (400-Mil) Molded SOJ		
	CY7C1009-15VC	V32	32-Lead (300-Mil) Molded SOJ		
	CY7C1009L-15VC	V32	32-Lead (300-Mil) Molded SOJ		
	CY7C109-15ZC	Z32	32-Lead TSOP Type I		
20	CY7C109-20VC	V33	32-Lead (400-Mil) Molded SOJ		Commercial
	CY7C1009-20VC	V32	32-Lead (300-Mil) Molded SOJ		
	CY7C109-20VI	V33	32-Lead (400-Mil) Molded SOJ	Industrial	
	CY7C109-20ZC	Z32	32-Lead TSOP Type I	Commercial	
	CY7C109-20ZI	Z32	32-Lead TSOP Type I	Industrial	
25	CY7C109-25VC	V33	32-Lead (400-Mil) Molded SOJ	Commercial	
	CY7C1009-25VC	V32	32-Lead (300-Mil) Molded SOJ		
	CY7C109-25VI	V33	32-Lead (400-Mil) Molded SOJ	Industrial	
	CY7C109-25ZC	Z32	32-Lead TSOP Type I	Commercial	
	CY7C109-25ZI	Z32	32-Lead TSOP Type I	Industrial	
35	CY7C109-35VC	V33	32-Lead (400-Mil) Molded SOJ	Commercial	
	CY7C1009-35VC	V32	32-Lead (300-Mil) Molded SOJ		
	CY7C109-35VI	V33	32-Lead (400-Mil) Molded SOJ	Industrial	

Shaded areas contain preliminary information.

Package Diagrams

32-Lead (300-Mil) Molded SOJ V32

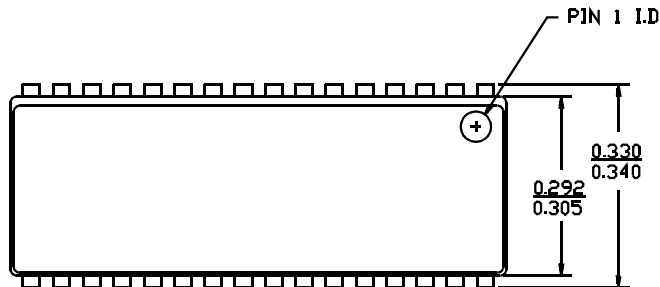

DIMENSIONS IN INCHES MIN.
MAX.

LEAD COPLANARITY 0.004 MAX.

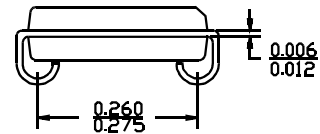
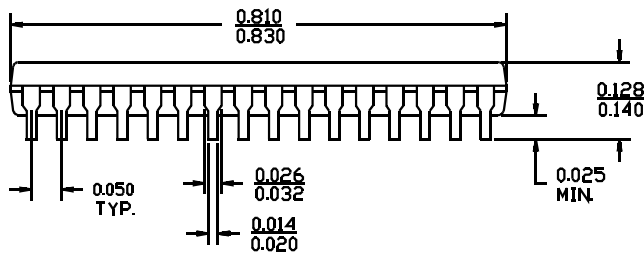

51-85041-A

32-Lead (400-Mil) Molded SOJ V33

DIMENSIONS IN INCHES MIN.
MAX.

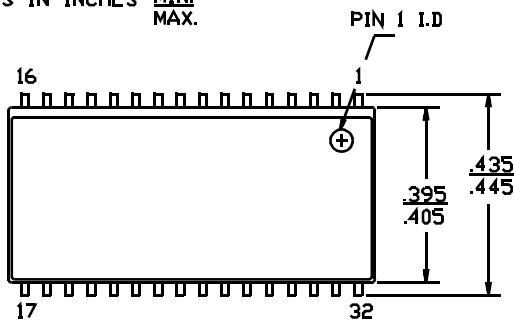

DETAIL A
EXTERNAL LEAD DESIGN

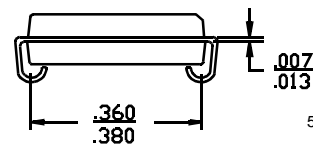
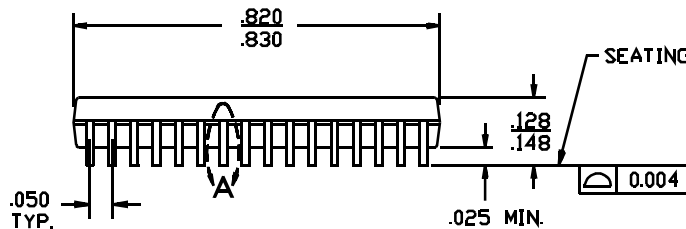
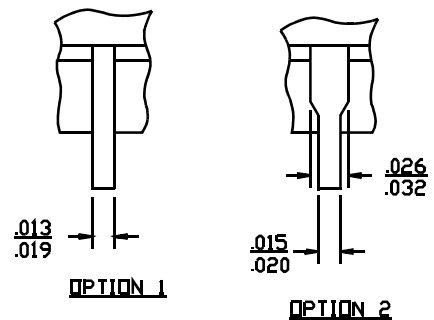

51-85033-A

Package Diagrams (continued)

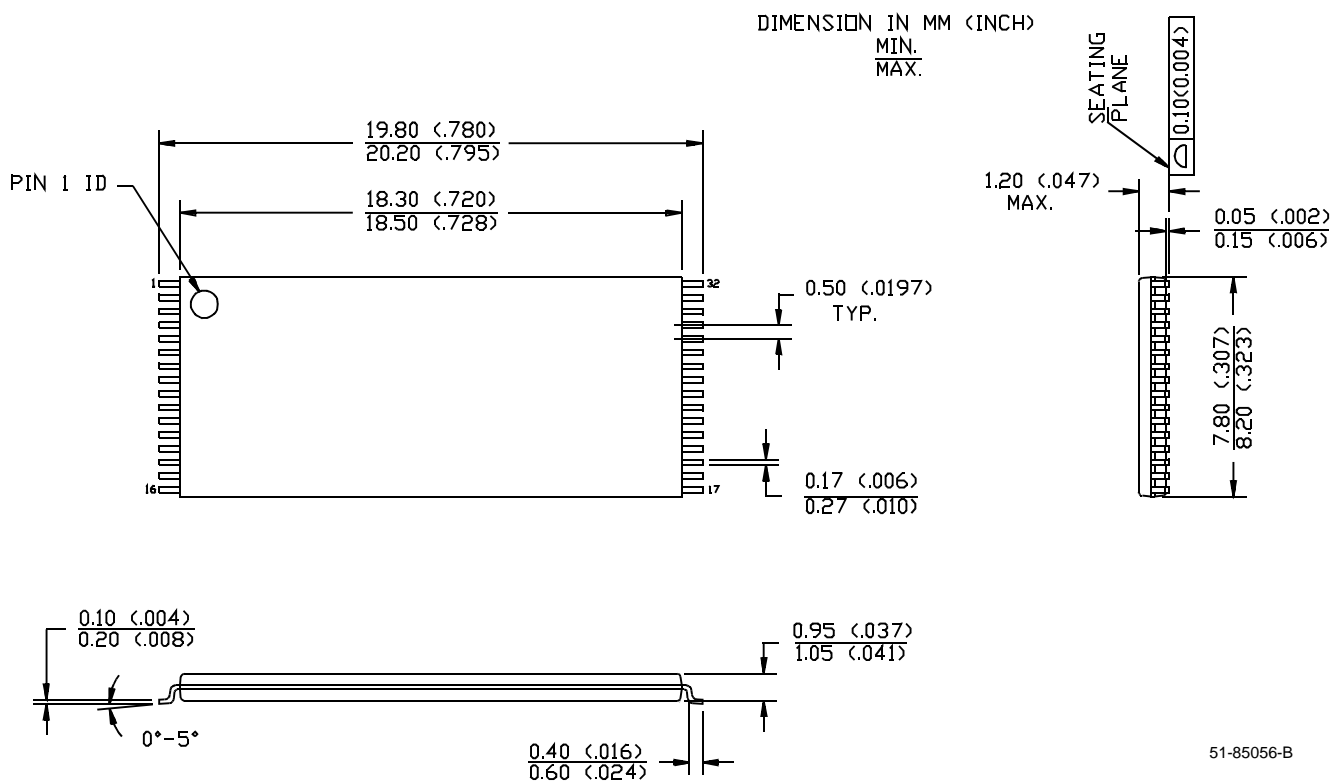
32-Lead Thin Small Outline Package Z32

51-85056-B

Document Title: CY7C109, CY7C1009 128K x 8 Static RAM
Document Number: 38-05032

REV.	ECN NO.	Issue Date	Orig. of Change	Description of Change
**	106826	09/15/01	SZV	Change from Spec number: 38-00140 to 38-05032