

BIPOLAR ANALOG INTEGRATED CIRCUIT

μ PC37M31, 37M32

TWO-OUTPUT POSITIVE VOLTAGE REGULATORS

DESCRIPTION

The μ PC37M31 and 37M32 are series regulators with two outputs, OUTPUT₁: 1 A and OUTPUT₂: 0.5 A, built in a single package. OUTPUT₁ outputs 3.3 V and OUTPUT₂ outputs 1.8 V and 2.5 V. These regulators can be used to realize set miniaturization and component reduction due to the use of on MP-3 or MP-3Z package.

FEATURES

- Two outputs, 3.3 V and 1.8 V or 2.5 V, built in a single package
- Output voltage accuracy: $\pm 2\%$
- Peak output current: OUTPUT₁: 1 A, OUTPUT₂: 0.5 A
- On-chip saturation protector at low input voltage
- On-chip overcurrent limiter
- On-chip thermal protection

PIN CONFIGURATION (Marking Side)

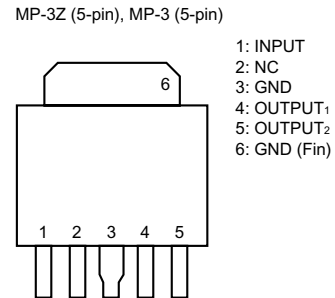

ORDERING INFORMATION

Part Number	Package	Marking	Packing Type
μ PC37MxxTJ	5-pin MP-3Z (SC-98)	37Mxx	• Bag stuffing
μ PC37MxxTJ-E1	5-pin MP-3Z (SC-98)	37Mxx	• Embossed-type taping (16 mm tape) • Pin 1 on drawout side • 2000 pcs/reel
μ PC37MxxTJ-E2	5-pin MP-3Z (SC-98)	37Mxx	• Embossed-type taping (16 mm tape) • Pin 1 on take up side • 2000 pcs/reel
μ PC37MxxHB	5-pin MP-3 (SC-99)	37Mxx	• Bag stuffing

"xx" in the part number and marking columns indicates the following.

Example

Output Voltage		Part Number	Marking
OUTPUT ₁	OUTPUT ₂		
3.3 V	1.8 V	μ PC37M31TJ	37M31
3.3 V	2.5 V	μ PC37M32TJ	37M32

The information in this document is subject to change without notice. Before using this document, please confirm that this is the latest version.

Not all products and/or types are available in every country. Please check with NEC Electronics sales representative for availability and additional information.

ABSOLUTE MAXIMUM RATINGS (T_A = 25°C, unless otherwise specified)

Parameter	Symbol	Rating	Unit
Input Voltage	V _{IN}	-0.3 to +8	V
Internal Power Dissipation (T _c = 25°C)	P _T	10 ^{Note}	W
Operating Ambient Temperature	T _A	-40 to +85	°C
Operating Junction Temperature	T _J	-40 to +150	°C
Storage Temperature	T _{stg}	-55 to +150	°C
Thermal Resistance (junction to case)	R _{th (J-C)}	12.5	°C/W
Thermal Resistance (junction to ambient)	R _{th (J-A)}	125	°C/W

Note Internally limited. When the operating junction temperature rises over 150°C, the internal circuit shuts down the output voltage.

Caution Product quality may suffer if the absolute maximum rating is exceeded even momentarily for any parameter. That is, the absolute maximum ratings are rated values at which the product is on the verge of suffering physical damage, and therefore the product must be used under conditions that ensure that the absolute maximum ratings are not exceeded.

TYPICAL CONNECTION

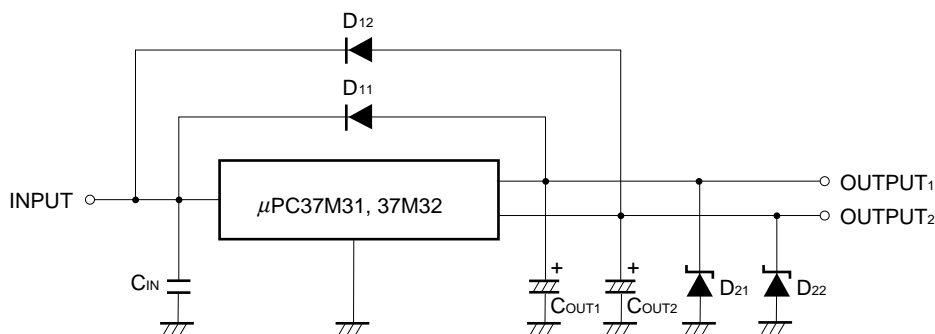

C_{IN}: 0.1 μF or higher. Set this value according to the length of the line between the regulator and INPUT pin. Be sure to connect C_{IN} to prevent parasitic oscillation. Use of a film capacitor or other capacitor with excellent voltage and temperature characteristics is recommended. If using a laminated ceramic capacitor, it is necessary to ensure that C_{IN} is 0.1 μF or higher for the voltage and temperature range to be used.

C_{OUT1}, C_{OUT2}: 10 μF or higher. Be sure to connect C_{OUT1} and C_{OUT2} to prevent oscillation and improve excessive load regulation. Place C_{IN}, C_{OUT1} and C_{OUT2} as close as possible to the IC pins (within 2 cm). Also, use an electrolytic capacitor with low impedance characteristics if considering use at sub-zero temperatures.

D₁₁, D₁₂: If the OUTPUT₁ pin or OUTPUT₂ pin has a higher voltage than the INPUT pin, connect a diode.

D₂₁, D₂₂: If the OUTPUT₁ pin or OUTPUT₂ pin has a lower voltage than the GND pin, connect a Schottky barrier diode.

Caution Make sure that no voltage is applied to the OUTPUT₁ pin or OUTPUT₂ pin from external.

RECOMMENDED OPERATING CONDITIONS

Parameter	Symbol	MIN.	TYP.	MAX.	Unit
Input Voltage	V _{IN}	4.5		6.0	V
Output Current 1	I _{O1}	0		0.5	A
Output Current 2	I _{O2}	0		0.3	A
Operating Ambient Temperature	T _A	-40		+85	°C
Operating Junction Temperature	T _J	-40		+125	°C

Caution Use of conditions other than the above-listed recommended operating conditions is not a problem as long as the absolute maximum ratings are not exceeded. However, since the use of such conditions diminishes the margin of safety, careful evaluation is required before such conditions are used. Moreover, using the MAX. value for all the recommended operating conditions is not guaranteed to be safe.

ELECTRICAL CHARACTERISTICS

μPC37M31 (T_J = 25°C, V_{IN} = 5 V, I_{O1} = 0.5 A, I_{O2} = 0.3 A, unless otherwise specified)

	Parameter	Symbol	Conditions	MIN.	TYP.	MAX.	Unit
OUTPUT ₁ (3.3 V)	Output Voltage 1	V _{O1}		3.234	3.3	3.366	V
	Line Regulation 1	REG _{IN1}	4.5 V ≤ V _{IN} ≤ 6.0 V	-	2	9	mV
	Load Regulation 1	REG _{L1}	5 mA ≤ I _O ≤ 1 A	-	20	66	mV
	Output Noise Voltage 1	V _{n1}	10 Hz ≤ I _O ≤ 100 kHz	-	76	-	μVr.m.s.
	Ripple Rejection 1	R•R ₁	f = 120 Hz, 4.5 V ≤ V _{IN} ≤ 6.0 V	-	57	-	dB
	Short Circuit Current 1	I _{Oshort1}	V _{IN} = 6.0 V	-	0.5	-	A
	Peak Output Current 1	I _{Opeak1}	V _{IN} = 5.0 V	1.0	1.4	-	A
	Temperature Coefficient of Output Voltage 1	ΔV _{O1} /ΔT	I _O = 5 mA, 0°C ≤ T _J ≤ 125°C	-	-0.4	-	mV/°C
OUTPUT ₂ (1.8 V)	Output Voltage 2	V _{O2}		1.764	1.8	1.836	V
	Line Regulation 2	REG _{IN2}	4.5 V ≤ V _{IN} ≤ 6.0 V	-	2	9	mV
	Load Regulation 2	REG _{L2}	5 mA ≤ I _O ≤ 0.5 A	-	17	50	mV
	Output Noise Voltage 2	V _{n2}	10 Hz ≤ I _O ≤ 100 kHz	-	60	-	μVr.m.s.
	Ripple Rejection 2	R•R ₂	f = 120 Hz, 4.5 V ≤ V _{IN} ≤ 6.0 V	-	60	-	dB
	Short Circuit Current 2	I _{Oshort2}	V _{IN} = 6.0 V	-	0.3	-	A
	Peak Output Current 2	I _{Opeak2}	V _{IN} = 5.0 V	0.5	0.8	-	A
	Temperature Coefficient of Output Voltage 2	ΔV _{O2} /ΔT	I _O = 5 mA, 0°C ≤ T _J ≤ 125°C	-	-0.4	-	mV/°C
Total	Quiescent Current	I _{BIAS}	I _{O1} = 0 A, I _{O2} = 0 A	-	4	8	mA
	Startup Quiescent Current	I _{BIAS(S)}	V _{IN} = 1.7 V, I _{O1} = 0 A, I _{O2} = 0 A	-	7	40	mA
	Dropout Voltage (INPUT to OUTPUT ₁)	V _{DIF1}	I _{O1} = 0.5 A	-	0.6	1.0	V

μPC37M32 (T_J = 25°C, V_{IN} = 5 V, I_{O1} = 0.5 A, I_{O2} = 0.3 A, unless otherwise specified)

	Parameter	Symbol	Conditions	MIN.	TYP.	MAX.	Unit
OUTPUT ₁ (3.3 V)	Output Voltage 1	V _{O1}		3.234	3.3	3.366	V
	Line Regulation 1	REG _{IN1}	4.5 V ≤ V _{IN} ≤ 6.0 V	–	2	9	mV
	Load Regulation 1	REG _{L1}	5 mA ≤ I _O ≤ 1 A	–	20	66	mV
	Output Noise Voltage 1	V _{n1}	10 Hz ≤ I _O ≤ 100 kHz	–	76	–	μVr.m.s.
	Ripple Rejection 1	R•R ₁	f = 120 Hz, 4.5 V ≤ V _{IN} ≤ 6.0 V	–	57	–	dB
	Short Circuit Current 1	I _{Oshort1}	V _{IN} = 6.0 V	–	0.5	–	A
	Peak Output Current 1	I _{Opeak1}	V _{IN} = 5.0 V	1.0	1.4	–	A
	Temperature Coefficient of Output Voltage 1	ΔV _{O1} /ΔT	I _O = 5 mA, 0°C ≤ T _J ≤ 125°C	–	–0.4	–	mV/°C
OUTPUT ₂ (2.5 V)	Output Voltage 2	V _{O2}		2.45	2.5	2.55	V
	Line Regulation 2	REG _{IN2}	4.5 V ≤ V _{IN} ≤ 6.0 V	–	2	9	mV
	Load Regulation 2	REG _{L2}	5 mA ≤ I _O ≤ 0.5 A	–	17	50	mV
	Output Noise Voltage 2	V _{n2}	10 Hz ≤ I _O ≤ 100 kHz	–	60	–	μVr.m.s.
	Ripple Rejection 2	R•R ₂	f = 120 Hz, 4.5 V ≤ V _{IN} ≤ 6.0 V	–	60	–	dB
	Short Circuit Current 2	I _{Oshort2}	V _{IN} = 6.0 V	–	0.3	–	A
	Peak Output Current 2	I _{Opeak2}	V _{IN} = 5.0 V	0.5	0.8	–	A
	Temperature Coefficient of Output Voltage 2	ΔV _{O2} /ΔT	I _O = 5 mA, 0°C ≤ T _J ≤ 125°C	–	–0.4	–	mV/°C
Total	Quiescent Current	I _{BIAS}	I _{O1} = 0 A, I _{O2} = 0 A	–	4	8	mA
	Startup Quiescent Current	I _{BIAS (S)}	V _{IN} = 2.4 V, I _{O1} = 0 A, I _{O2} = 0 A	–	7	40	mA
	Dropout Voltage (INPUT to OUTPUT ₁)	V _{DIF1}	I _{O1} = 0.5 A	–	0.6	1.0	V

TYPICAL CHARACTERISTICS (Reference Values)

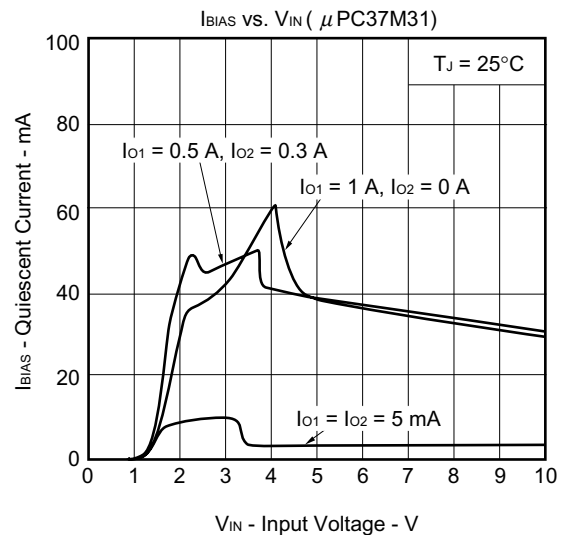
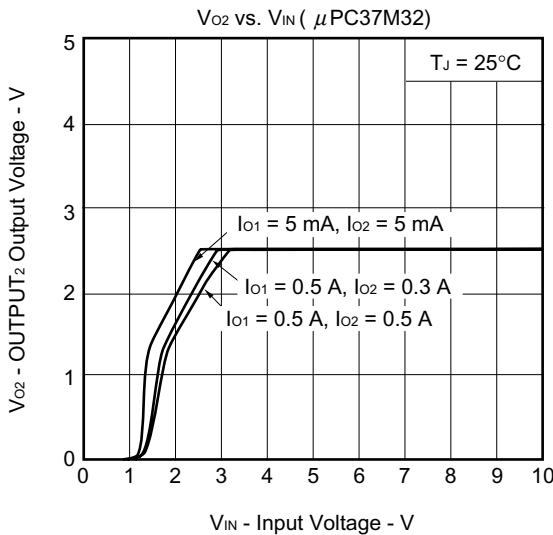
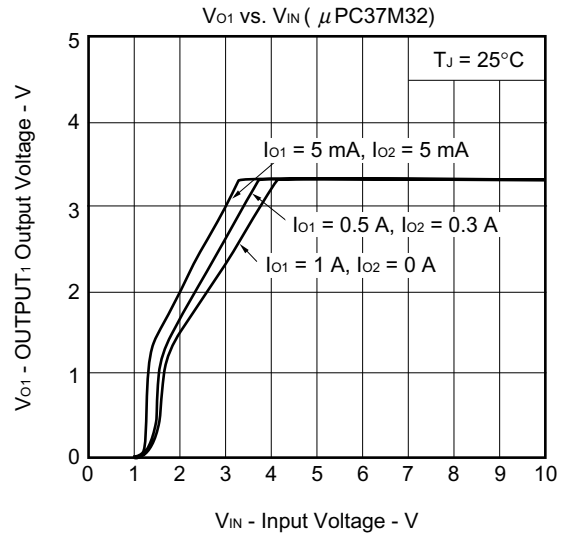
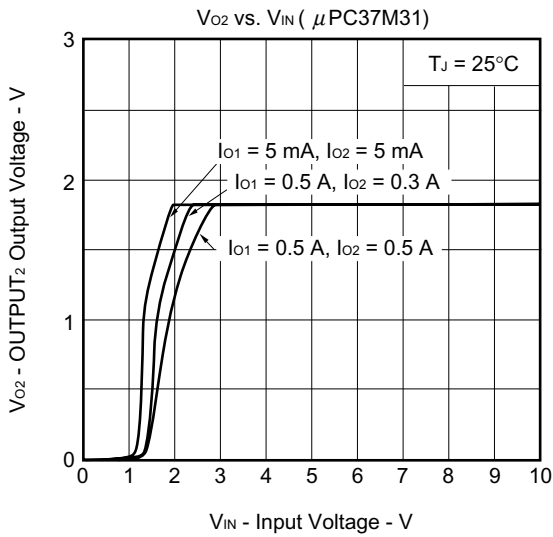
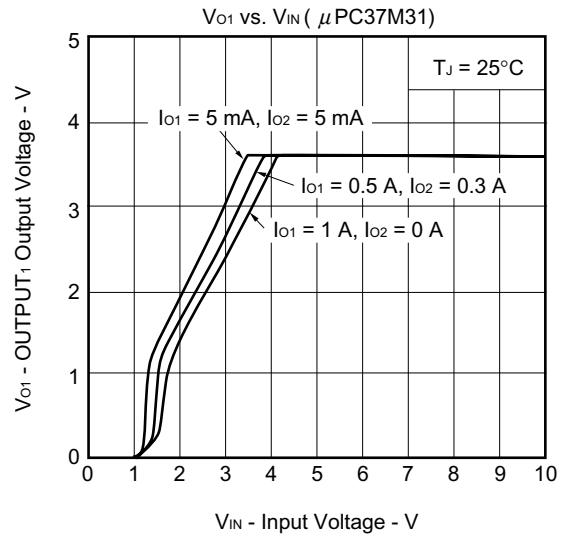
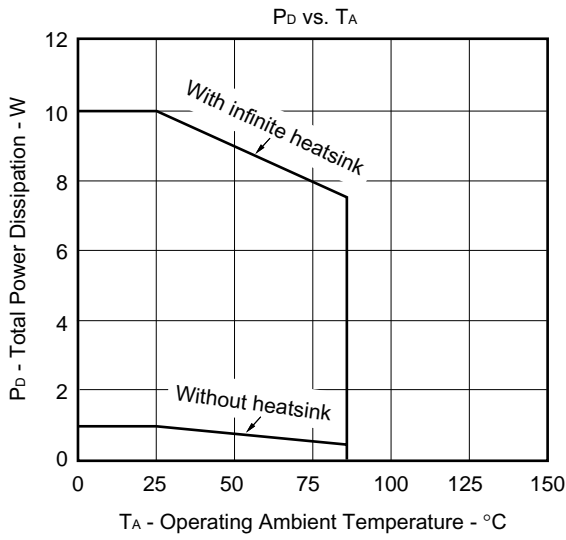

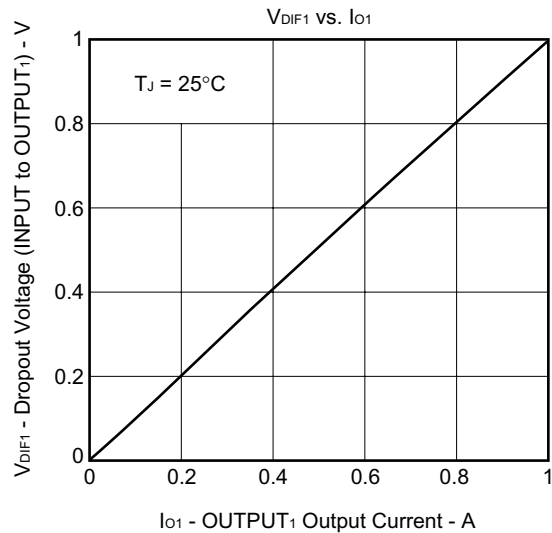
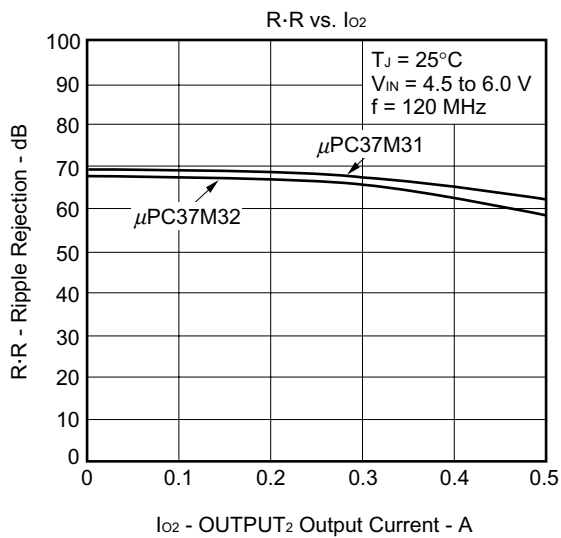
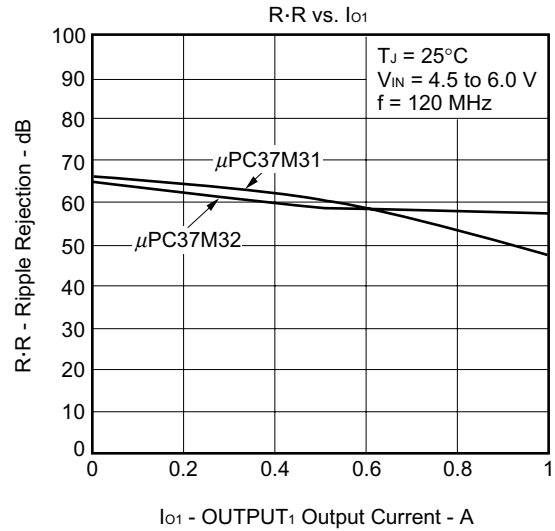
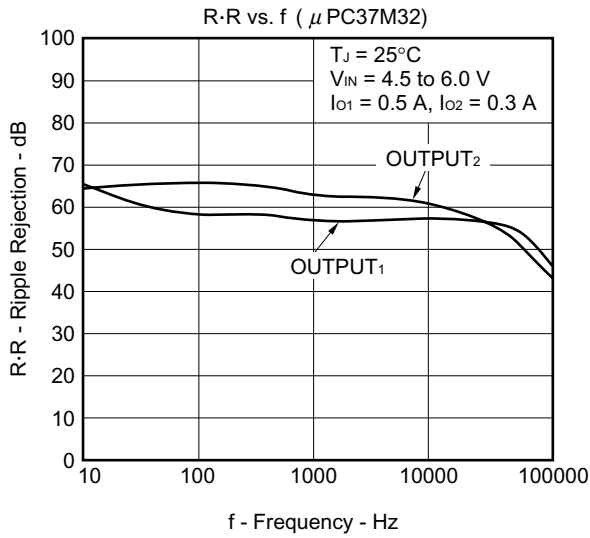
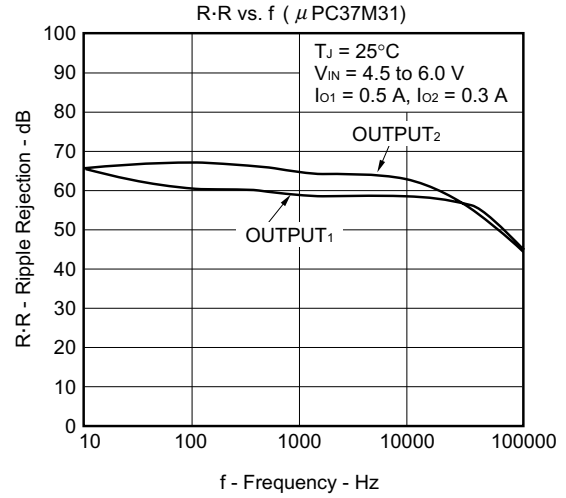
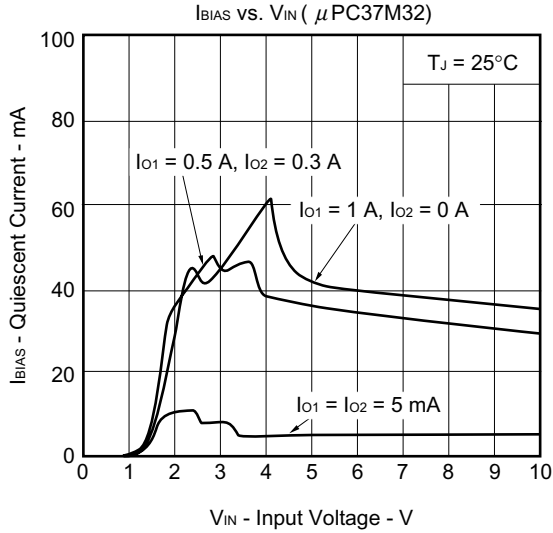

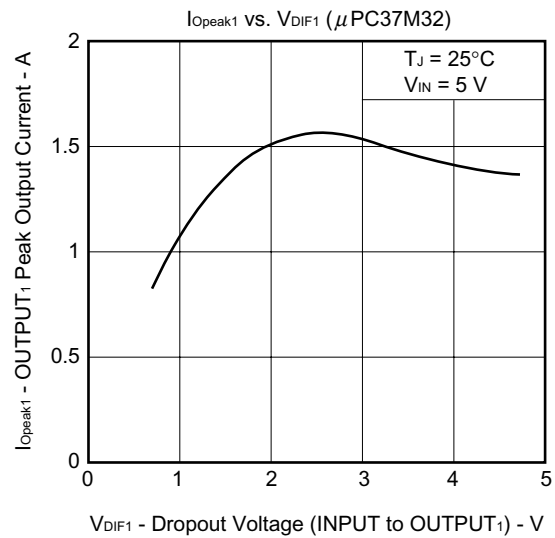
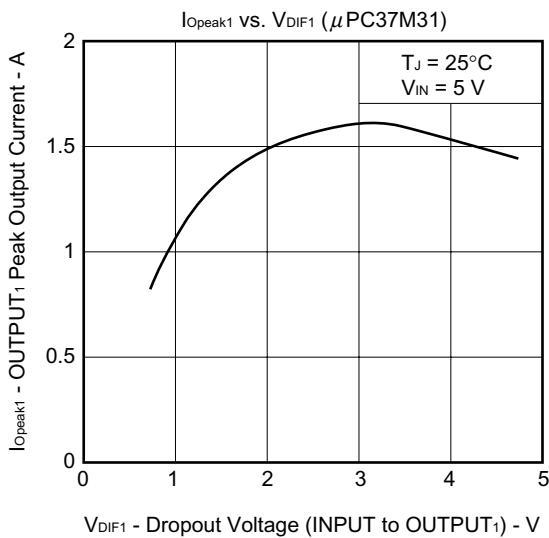
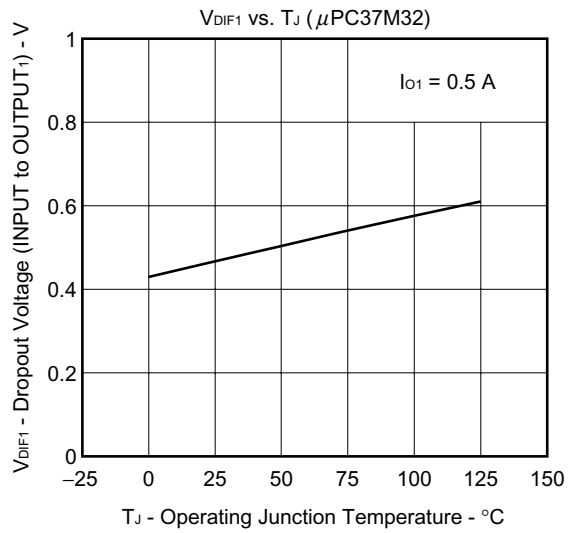
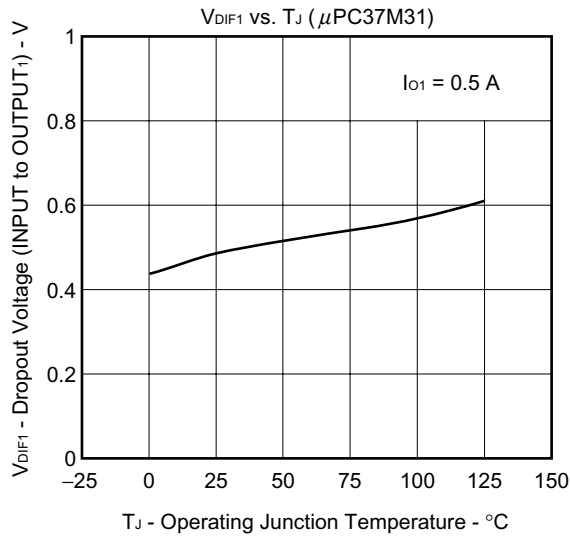
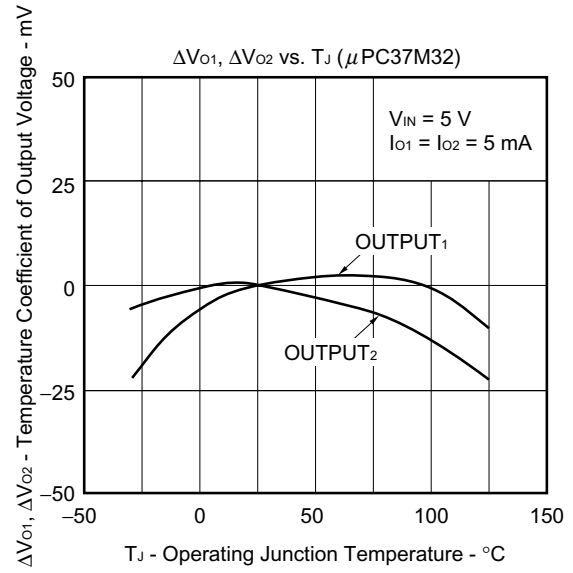
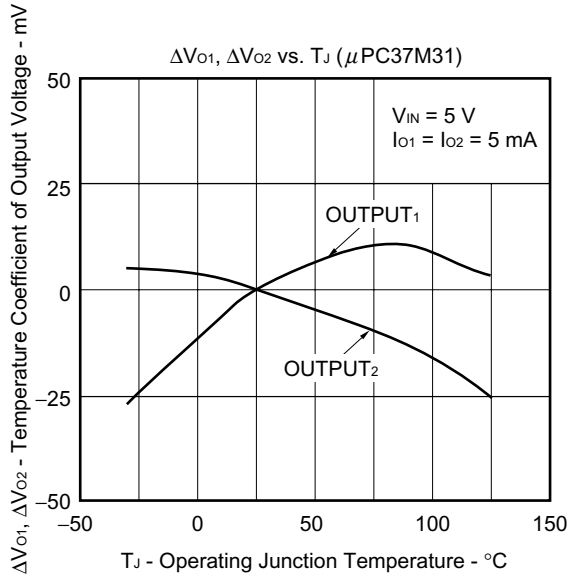

PACKAGE DRAWINGS (Unit: mm)

MP-3Z (5-pin)

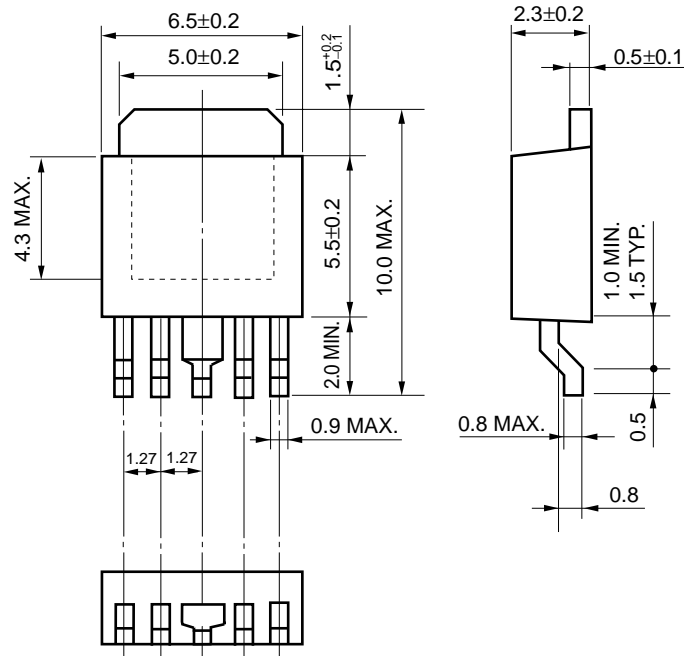

MP-3 (5-pin)

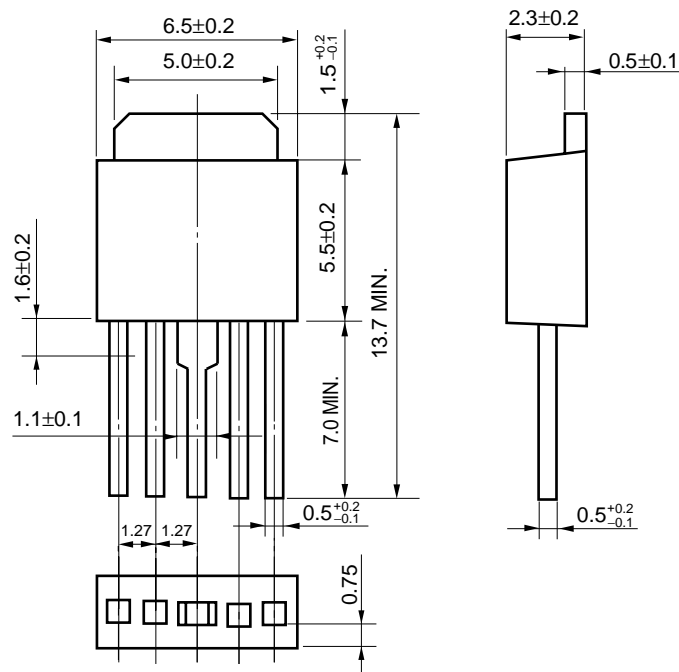

RECOMMENDED MOUNTING CONDITIONS

The following conditions must be met for mounting conditions of the μPC37M31 and 37M32.

For more details, refer to the **Semiconductor Device Mounting Technology Manual (C10535E)**.

Please consult with our sales offices in case other mounting process is used, or in case the mounting is done under different conditions.

Type of Surface Mount Device

μ PC37M31TJ, μ PC37M32TJ: MP-3Z (5-pin)

Process	Conditions	Symbol
Infrared Ray Reflow	Peak temperature: 235°C or below (Package surface temperature), Reflow time: 30 seconds or less (at 210°C or higher), Maximum number of reflows processes: 3 times or less.	IR35-00-3
Vapor Phase Soldering	Peak temperature: 215°C or below (Package surface temperature), Reflow time: 40 seconds or less (at 200°C or higher), Maximum number of reflows processes: 3 times or less.	VP15-00-3
Wave Soldering	Solder temperature: 260°C or below, Flow time: 10 seconds or less, Maximum number of flow processes: 1 time, Pre-heating temperature: 120°C or below (Package surface temperature).	WS60-00-1
Partial Heating Method	Pin temperature: 300°C or below, Heat time: 3 seconds or less (Per each side of the device).	-

Caution Apply only one kind of soldering condition to a device, except for "partial heating method", or the device will be damaged by heat stress.

Type of Through-hole Device

μ PC37M31HB, μ PC37M32HB: MP-3 (5-pin)

Process	Conditions
Wave Soldering (only to leads)	Solder temperature: 260°C or below, Flow time: 10 seconds or less
Partial Heating Method	Pin temperature: 300°C or below, Heat time: 3 seconds or less (Per each pin).

Caution For through-hole device, the wave soldering process must be applied only to leads, and make sure that the package body does not get jet soldered.

CAUTION ON USE

When the μPC37M31 and 37M32 are used with an input voltage that is lower than the value indicated in the recommended operating conditions, a large quiescent current flows through the device due to saturation of the transistor of the output stage. (Refer to the I_{BIAS} (I_{BIAS(S)}) vs. V_{IN} curves in TYPICAL CHARACTERISTICS).

These products have saturation protector, but a current of up to 70 mA MAX. may flow through the device. Thus, the power supply on the input side must have sufficient capacity to allow this quiescent current to pass when the device starts up.

REFERENCE DOCUMENTS

Document Name		Document No.
Usage of Three-Terminal Regulators	User's Manual	G12702E
Voltage Regulator of SMD	Information	G11872E
Semiconductor Device Mounting Technology Manual	Information	C10535E
SEMICONDUCTOR SELECTION GUIDE - Products and Packages-		X13769X

- **The information in this document is current as of November, 2002. The information is subject to change without notice. For actual design-in, refer to the latest publications of NEC Electronics data sheets or data books, etc., for the most up-to-date specifications of NEC Electronics products. Not all products and/or types are available in every country. Please check with NEC Electronics sales representative for availability and additional information.**
- No part of this document may be copied or reproduced in any form or by any means without prior written consent of NEC Electronics. NEC Electronics assumes no responsibility for any errors that may appear in this document.
- NEC Electronics does not assume any liability for infringement of patents, copyrights or other intellectual property rights of third parties by or arising from the use of NEC Electronics products listed in this document or any other liability arising from the use of such NEC Electronics products. No license, express, implied or otherwise, is granted under any patents, copyrights or other intellectual property rights of NEC Electronics or others.
- Descriptions of circuits, software and other related information in this document are provided for illustrative purposes in semiconductor product operation and application examples. The incorporation of these circuits, software and information in the design of customer's equipment shall be done under the full responsibility of customer. NEC Electronics assumes no responsibility for any losses incurred by customers or third parties arising from the use of these circuits, software and information.
- While NEC Electronics endeavors to enhance the quality, reliability and safety of NEC Electronics products, customers agree and acknowledge that the possibility of defects thereof cannot be eliminated entirely. To minimize risks of damage to property or injury (including death) to persons arising from defects in NEC Electronics products, customers must incorporate sufficient safety measures in their design, such as redundancy, fire-containment and anti-failure features.
- NEC Electronics products are classified into the following three quality grades: "Standard", "Special" and "Specific".

The "Specific" quality grade applies only to NEC Electronics products developed based on a customer-designated "quality assurance program" for a specific application. The recommended applications of NEC Electronics product depend on its quality grade, as indicated below. Customers must check the quality grade of each NEC Electronics product before using it in a particular application.

"Standard": Computers, office equipment, communications equipment, test and measurement equipment, audio and visual equipment, home electronic appliances, machine tools, personal electronic equipment and industrial robots.

"Special": Transportation equipment (automobiles, trains, ships, etc.), traffic control systems, anti-disaster systems, anti-crime systems, safety equipment and medical equipment (not specifically designed for life support).

"Specific": Aircraft, aerospace equipment, submersible repeaters, nuclear reactor control systems, life support systems and medical equipment for life support, etc.

The quality grade of NEC Electronics products is "Standard" unless otherwise expressly specified in NEC Electronics data sheets or data books, etc. If customers wish to use NEC Electronics products in applications not intended by NEC Electronics, they must contact NEC Electronics sales representative in advance to determine NEC Electronics's willingness to support a given application.

(Note)

- (1) "NEC Electronics" as used in this statement means NEC Electronics Corporation and also includes its majority-owned subsidiaries.
- (2) "NEC Electronics products" means any product developed or manufactured by or for NEC Electronics (as defined above).