

5 V, SILICON GERMANIUM MMIC MEDIUM OUTPUT POWER AMPLIFIER

DESCRIPTION

The μ PC3225TB is a silicon germanium (SiGe) monolithic integrated circuits designed as IF amplifier for DBS tuners. This IC is manufactured using our 50 GHz f_{max} UHS2 (Ultra High Speed Process) SiGe bipolar process.

FEATURES

- Wideband response : $f_u = 2.8$ GHz TYP. @ 3 dB bandwidth
- Low current : $I_{CC} = 24.5$ mA TYP.
- Medium output power : $P_{O(sat)} = +15.5$ dBm TYP. @ $f = 0.95$ GHz
: $P_{O(sat)} = +12.5$ dBm TYP. @ $f = 2.15$ GHz
- High linearity : $P_{O(1dB)} = +9.0$ dBm TYP. @ $f = 0.95$ GHz
: $P_{O(1dB)} = +7.0$ dBm TYP. @ $f = 2.15$ GHz
- Power gain : $G_P = 32.5$ dB TYP. @ $f = 0.95$ GHz
: $G_P = 33.5$ dB TYP. @ $f = 2.15$ GHz
- Noise Figure : $NF = 3.7$ dB TYP. @ $f = 0.95$ GHz
: $NF = 3.7$ dB TYP. @ $f = 2.15$ GHz
- Supply voltage : $V_{CC} = 4.5$ to 5.5 V
- Port impedance : input/output 50Ω

APPLICATIONS

- IF amplifiers in LNB for DBS converters etc.

ORDERING INFORMATION

Part Number	Order Number	Package	Marking	Supplying Form
μ PC3225TB-E3	μ PC3225TB-E3-A	6-pin super minimold (Pb-Free) ^{Note}	C3M	Embossed tape 8 mm wide. 1, 2, 3 pins face the perforation side of the tape. Qty 3 kpcs/reel.

Note With regards to terminal solder (the solder contains lead) plated products (conventionally plated), contact your nearby sales office.

Remark To order evaluation samples, please contact your nearby sales office
Part number for sample order: μ PC3225TB.

Caution Observe precautions when handling because these devices are sensitive to electrostatic discharge.

The information in this document is subject to change without notice. Before using this document, please confirm that this is the latest version.
Not all devices/types available in every country. Please check with local NEC Compound Semiconductor Devices representative for availability and additional information.

PIN CONNECTIONS

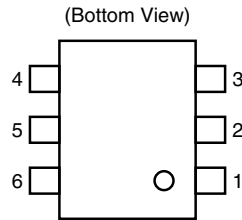
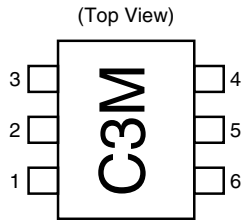

Pin No.	Pin Name
1	OUTPUT
2	GND
3	V _{CC}
4	INPUT
5	GND
6	GND

PRODUCT LINE-UP OF 5 V-BIAS SILICON MMIC MEDIUM OUTPUT POWER AMPLIFIER
 (T_A = +25°C, f = 1 GHz, V_{CC} = V_{out} = 5.0 V, Z_s = Z_L = 50 Ω)

Part No.	f _u (GHz)	P _{O (sat)} (dBm)	G _P (dB)	NF (dB)	I _{CC} (mA)	Package	Marking
μPC2708TB	2.9	+10.0	15	6.5	26	6-pin super minimold	C1D
μPC2709TB	2.3	+11.5	23	5.0	25		C1E
μPC2710TB	1.0	+13.5	33	3.5	22		C1F
μPC2776TB	2.7	+8.5	23	6.0	25		C2L
μPC3223TB	3.2	+12.0	23	4.5	19		C3J
μPC3225TB	2.8	+15.5 ^{Note}	32.5 ^{Note}	3.7 ^{Note}	24.5		C3M

Note f = 0.95 GHz

Remark Typical performance. Please refer to **ELECTRICAL CHARACTERISTICS** in detail.

PIN EXPLANATION

Pin No.	Pin Name	Applied Voltage (V)	Pin Voltage (V) ^{Note}	Function and Applications
4	INPUT	–	0.98	Signal input pin. A internal matching circuit, configured with resistors, enables 50 Ω connection over a wide band. A multi-feedback circuit is designed to cancel the deviations of h_{FE} and resistance. This pin must be coupled to signal source with capacitor for DC cut.
1	OUTPUT	Voltage as same as V_{CC} through external inductor	–	Signal output pin. The inductor must be attached between V_{CC} and output pins to supply current to the internal output transistors.
3	V_{CC}	4.5 to 5.5	–	Power supply pin. Which biases the internal input transistor. This pin should be externally equipped with bypass capacitor to minimize its impedance.
2 5 6	GND	0	–	Ground pin. This pin should be connected to system ground with minimum inductance. Ground pattern on the board should be formed as wide as possible. All the ground pins must be connected together with wide ground pattern to decrease impedance difference.

Note Pin voltage is measured at $V_{CC} = 5.0\text{ V}$

ABSOLUTE MAXIMUM RATINGS

Parameter	Symbol	Conditions	Ratings	Unit
Supply Voltage	V _{CC}	T _A = +25°C, Pin 1 and 3	6	V
Total Circuit Current	I _{CC}	T _A = +25°C	45	mA
Power Dissipation	P _D	T _A = +85°C Note	270	mW
Operating Ambient Temperature	T _A		-40 to +85	°C
Storage Temperature	T _{stg}		-55 to +150	°C
Input Power	P _{in}	T _A = +25°C	0	dBm

Note Mounted on double-sided copper-clad 50 × 50 × 1.6 mm epoxy glass PWB

RECOMMENDED OPERATING RANGE

Parameter	Symbol	Conditions	MIN.	TYP.	MAX.	Unit
Supply Voltage	V _{CC}	The same voltage should be applied to pin 1 and 3.	4.5	5.0	5.5	V
Operating Ambient Temperature	T _A		-40	+25	+85	°C

ELECTRICAL CHARACTERISTICS (T_A = +25°C, V_{CC} = V_{out} = 5.0 V, Z_s = Z_L = 50 Ω)

Parameter	Symbol	Test Conditions	MIN.	TYP.	MAX.	Unit
Circuit Current	I _{CC}	No input signal	20.0	24.5	31.0	mA
Power Gain	G _P	f = 0.95 GHz, P _{in} = -35.0 dBm	30.0	32.5	35.0	dB
		f = 2.15 GHz, P _{in} = -35.0 dBm	30.5	33.5	36.0	
Saturated Output Power	P _{O(sat)}	f = 0.95 GHz, P _{in} = -5.0 dBm	+13.5	+15.5	-	dBm
		f = 2.15 GHz, P _{in} = -5.0 dBm	+10.5	+12.5	-	
Gain 1 dB Compression Output Power	P _{O(1 dB)}	f = 0.95 GHz	+7.0	+9.0	-	dBm
		f = 2.15 GHz	+5.0	+7.0	-	
Noise Figure	NF	f = 0.95 GHz	-	3.7	4.5	dB
		f = 2.15 GHz	-	3.7	4.5	
Upper Limit Operating Frequency	f _u	3 dB down below flat gain at f = 0.95 GHz	-	2.8	-	GHz
Isolation	ISL	f = 0.95 GHz, P _{in} = -35.0 dBm	36.0	41.0	-	dB
		f = 2.15 GHz, P _{in} = -35.0 dBm	36.0	45.0	-	
Input Return Loss	RL _{in}	f = 0.95 GHz, P _{in} = -35.0 dBm	7.0	8.5	-	dB
		f = 2.15 GHz, P _{in} = -35.0 dBm	8.0	11.0	-	
Output Return Loss	RL _{out}	f = 0.95 GHz, P _{in} = -35.0 dBm	7.0	10.5	-	dB
		f = 2.15 GHz, P _{in} = -35.0 dBm	9.5	13.0	-	
Gain Flatness	ΔG _P	f = 0.95 to 2.15 GHz	-	2.5	4.0	dB

OTHER CHARACTERISTICS, FOR REFERENCE PURPOSES ONLY**(T_A = +25°C, V_{CC} = V_{out} = 5.0 V, Z_S = Z_L = 50 Ω)**

Parameter	Symbol	Test Conditions	Reference Value	Unit
Output intercept point	OIP ₃	f = 0.95 GHz	21.0	dBm
		f = 2.15 GHz	16.0	

TEST CIRCUIT

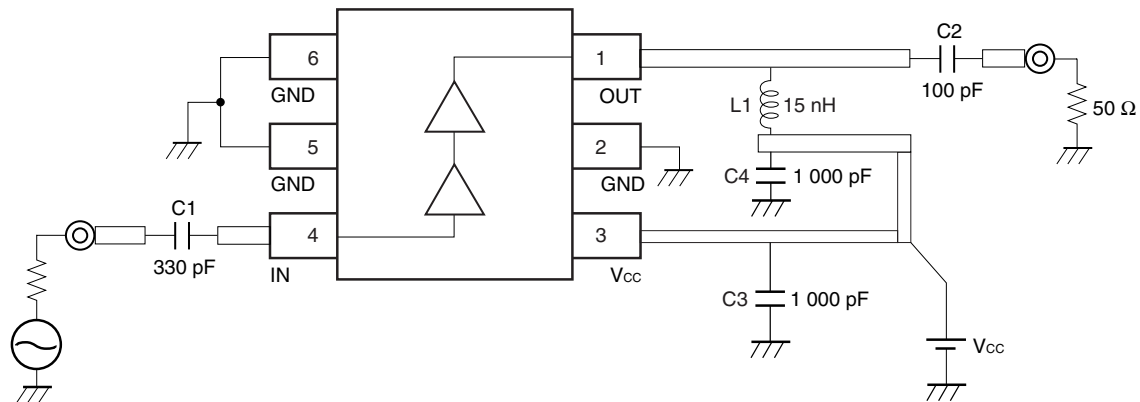

The application circuits and their parameters are for reference only and are not intended for use in actual design-ins.

COMPONENTS OF TEST CIRCUIT FOR MEASURING ELECTRICAL CHARACTERISTICS

	Value	Maker	Type code
C1	330 pF	Murata	GMR36CH
C2	100 pF	Murata	GMR36CH
C3	1 000 pF	Murata	GMR39CH
C4	1 000 pF	Murata	GMR36B
L1	15 nH	Susumu	TFL0816

INDUCTOR FOR THE OUTPUT PIN

The internal output transistor of this IC consumes 24.5 mA, to output medium power. To supply current for output transistor, connect an inductor between the Vcc pin (pin 3) and output pin (pin 1). Select inductance, as the value listed above.

The inductor has both DC and AC effects. In terms of DC, the inductor biases the output transistor with minimum voltage drop to output enable high level. In terms of AC, the inductor makes output-port impedance higher to get enough gain. In this case, large inductance and Q is suitable.

CAPACITORS FOR THE Vcc, INPUT AND OUTPUT PINS

Capacitors of 1 000 pF are recommendable as the bypass capacitor for the Vcc pin. Capacitors of 330 pF for the input pin and 100 pF for the output pin are recommendable as the coupling capacitors.

The bypass capacitor connected to the Vcc pin is used to minimize ground impedance of Vcc pin. So, stable bias can be supplied against Vcc fluctuation.

The coupling capacitors, connected to the input and output pins, are used to cut the DC and minimize RF serial impedance. Their capacitances are therefore selected as lower impedance against a 50 Ω load. The capacitors thus perform as high pass filters, suppressing low frequencies to DC.

ILLUSTRATION OF THE TEST CIRCUIT ASSEMBLED ON EVALUATION BOARD

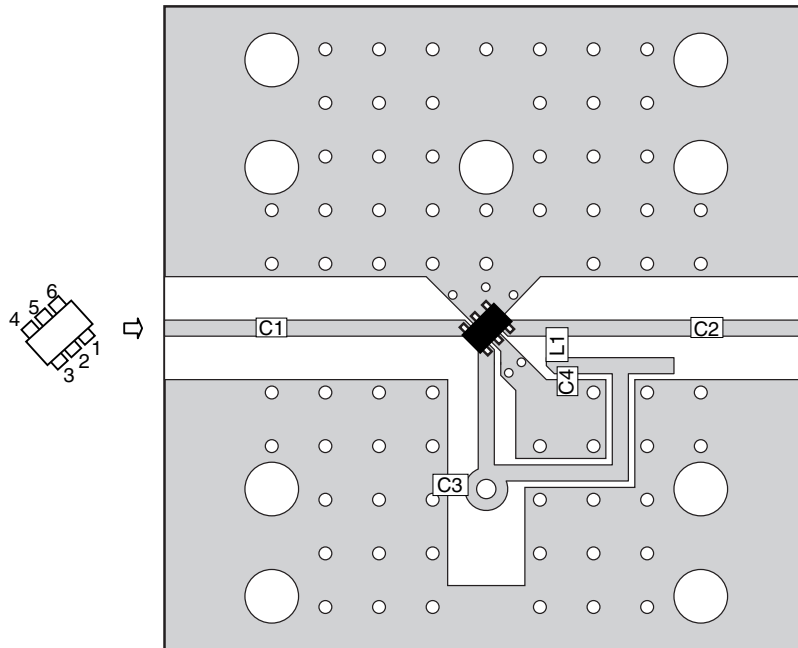

COMPONENT LIST

	Value
C1	330 pF
C2	100 pF
C3, C4	1 000 pF
L1	15 nH

Notes

1. 30 × 30 × 0.4 mm double sided copper clad polyimide board.
2. Back side: GND pattern
3. Solder plated on pattern
4. ○○: Through holes

TYPICAL CHARACTERISTICS ($V_{CC} = 5.0\text{ V}$, $T_A = +25^\circ\text{C}$, unless otherwise specified)

CIRCUIT CURRENT vs. SUPPLY VOLTAGE

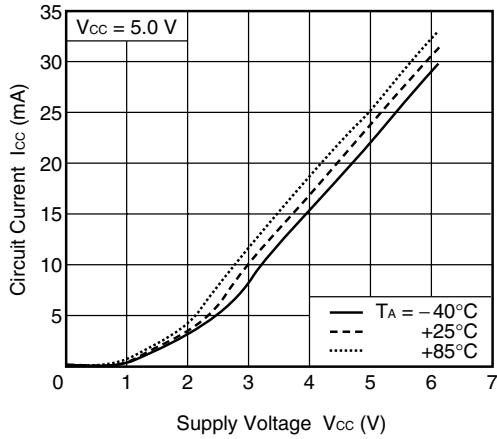

CIRCUIT CURRENT vs. OPERATING AMBIENT TEMPERATURE

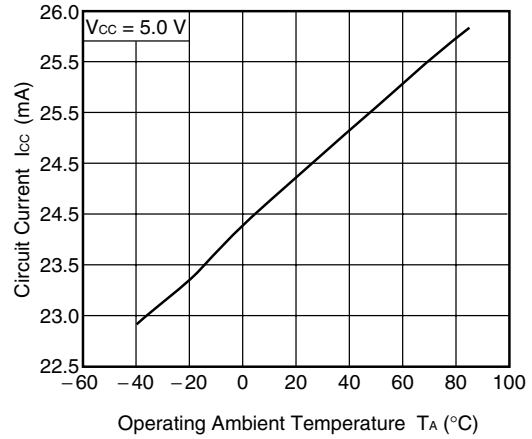

POWER GAIN vs. FREQUENCY

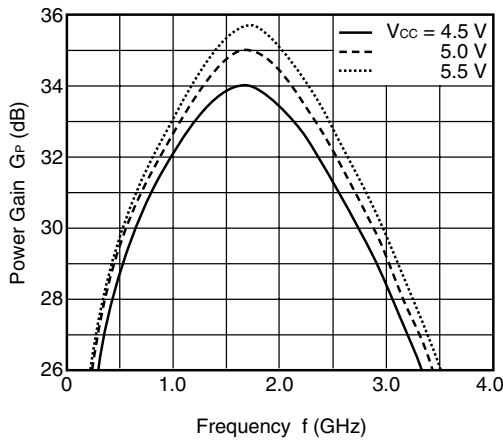

POWER GAIN vs. FREQUENCY

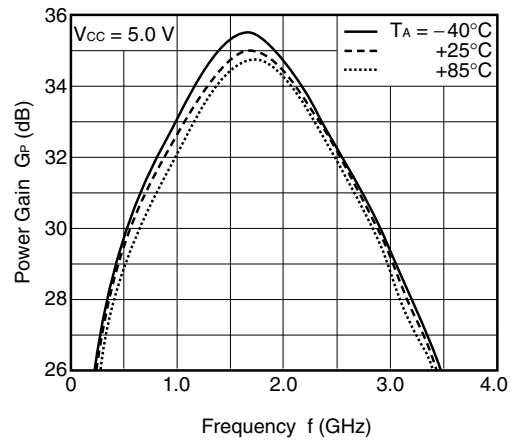

ISOLATION vs. FREQUENCY

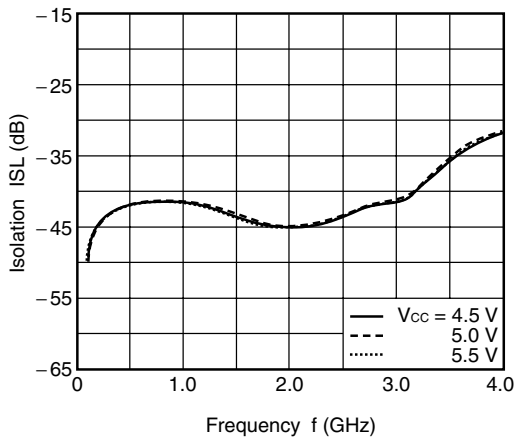

ISOLATION vs. FREQUENCY

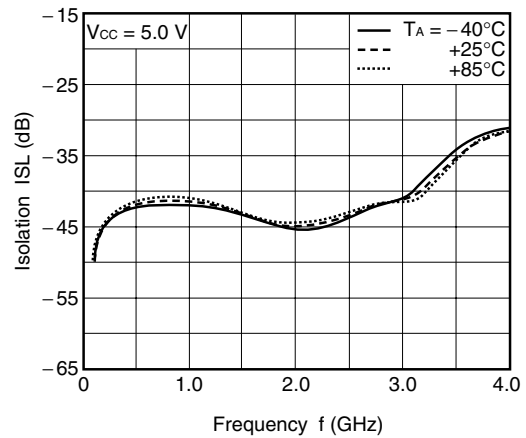

Remark The graphs indicate nominal characteristics.

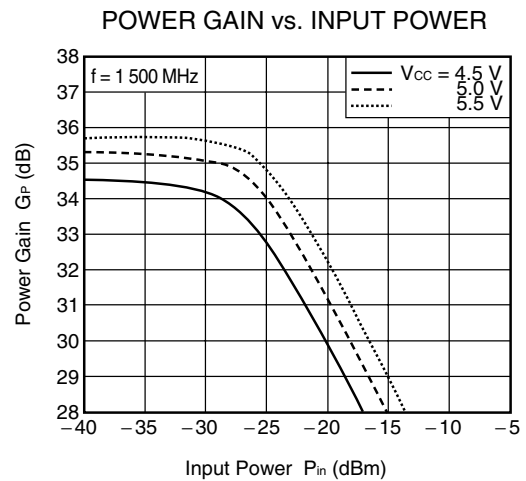
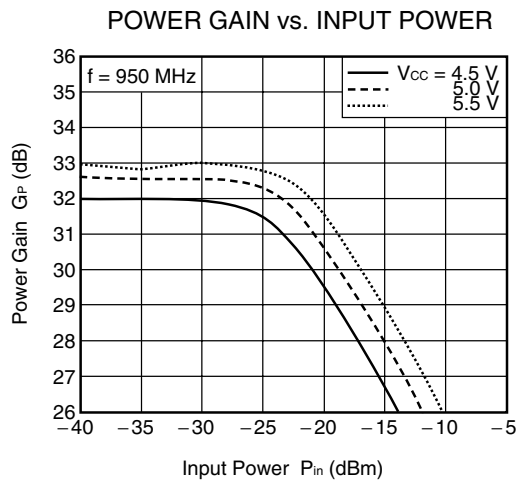
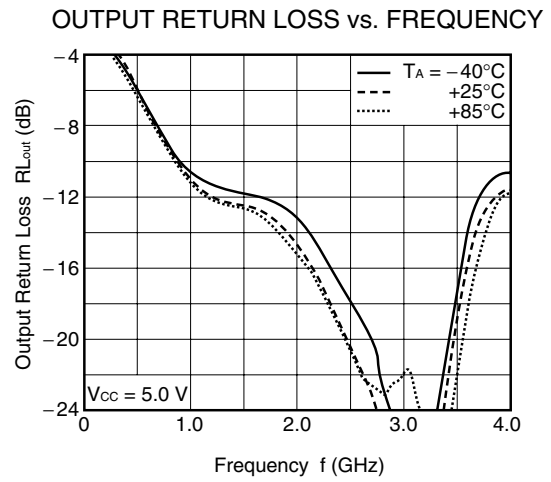
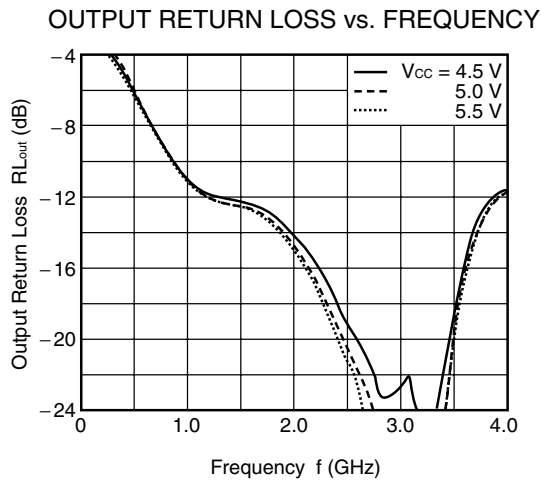
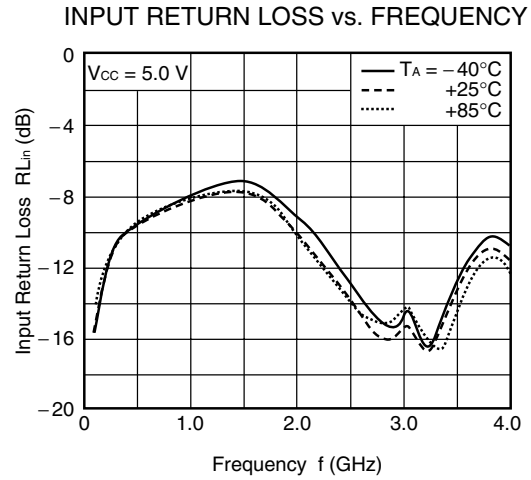
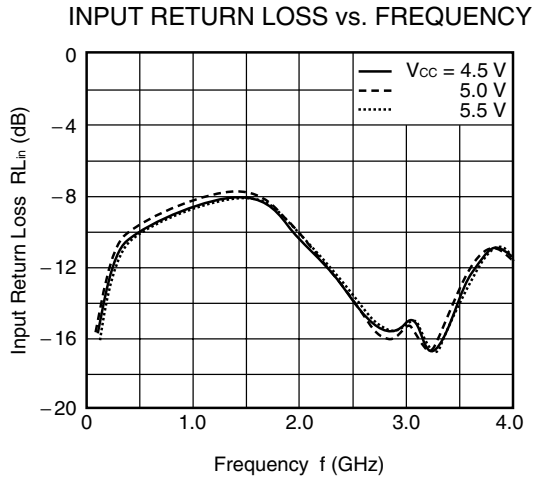

Remark The graphs indicate nominal characteristics.

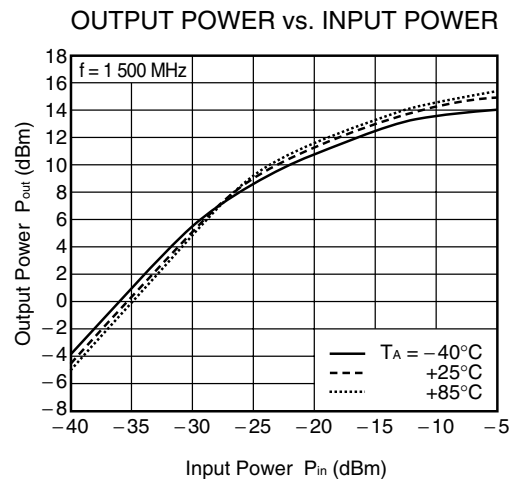
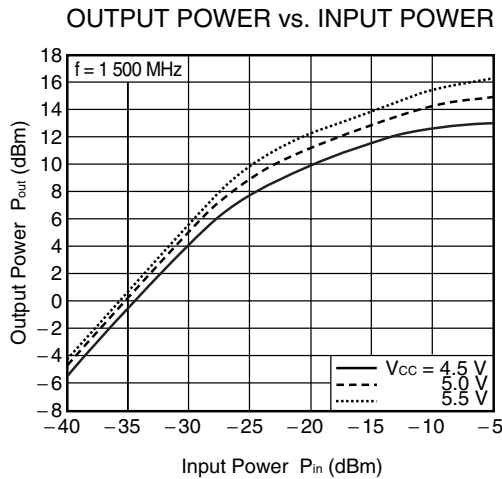
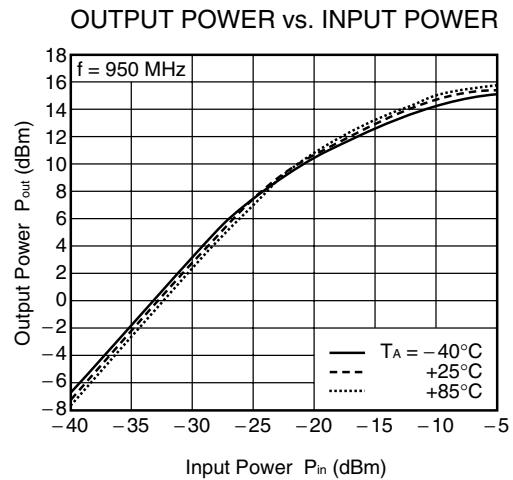
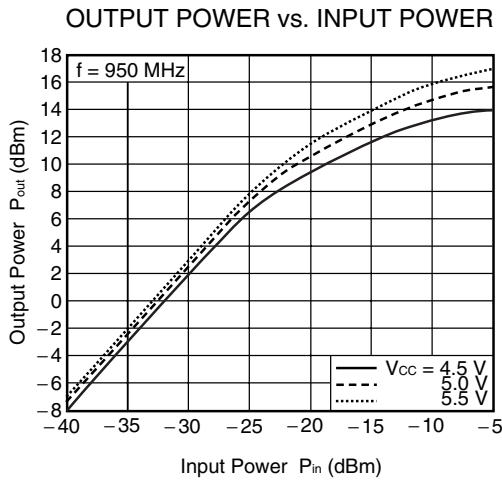
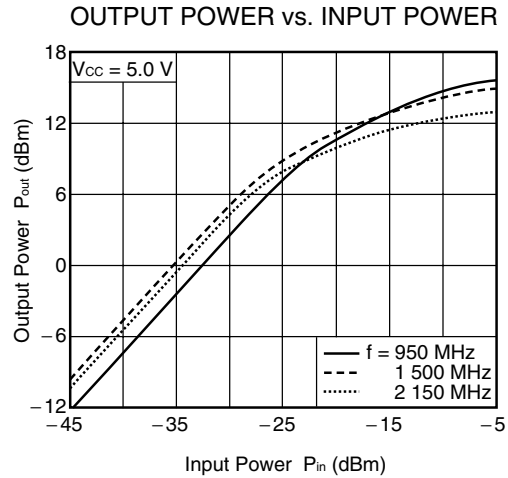
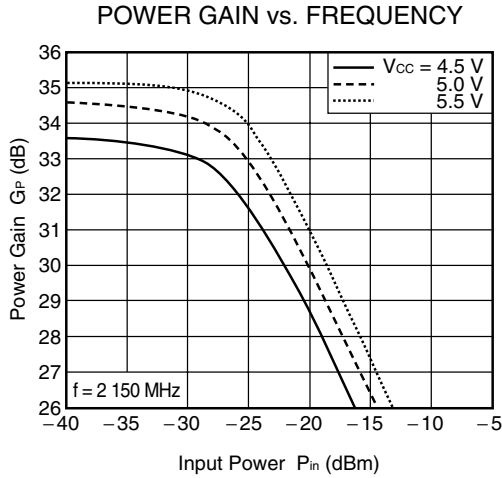

Remark The graphs indicate nominal characteristics.

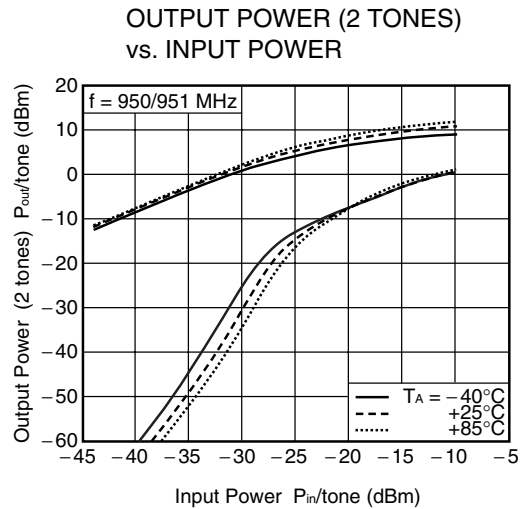
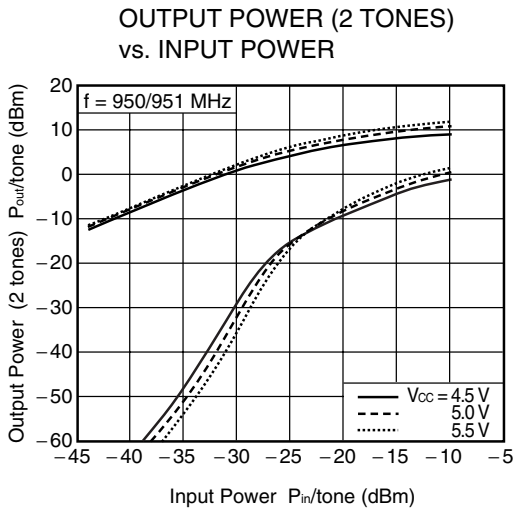
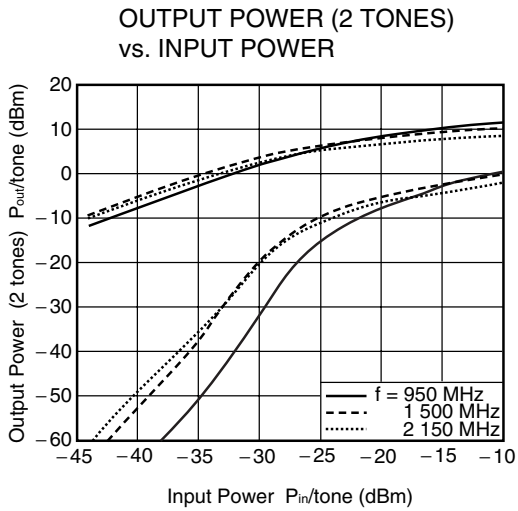
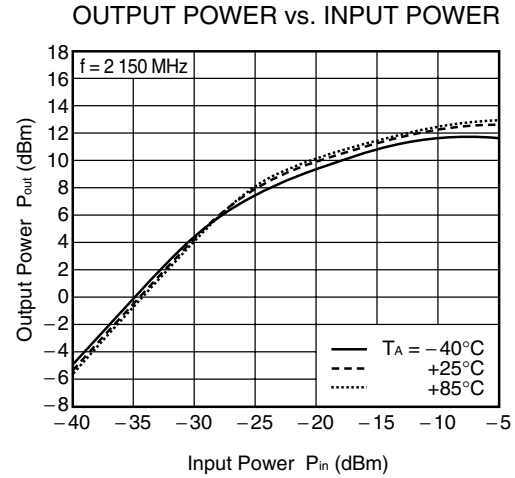
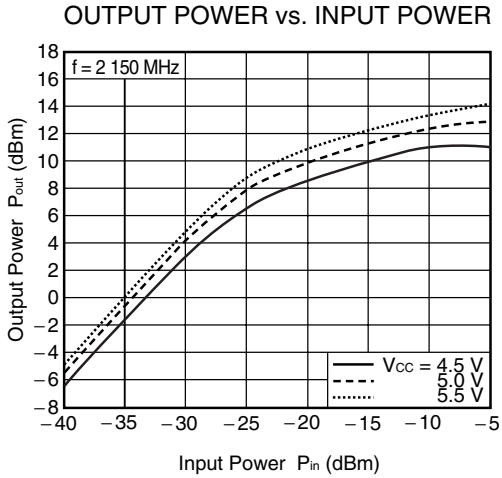

Remark The graphs indicate nominal characteristics.

OUTPUT POWER (2 TONES)
vs. INPUT POWER

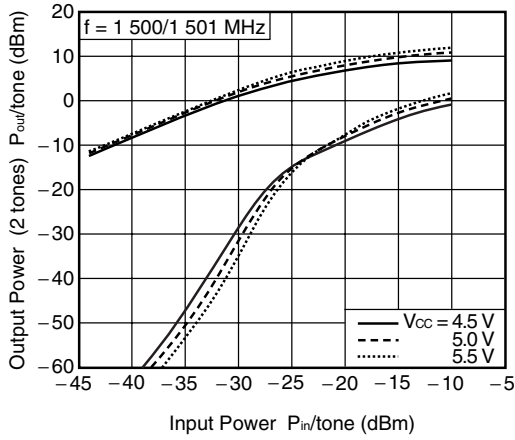

OUTPUT POWER (2 TONES)
vs. INPUT POWER

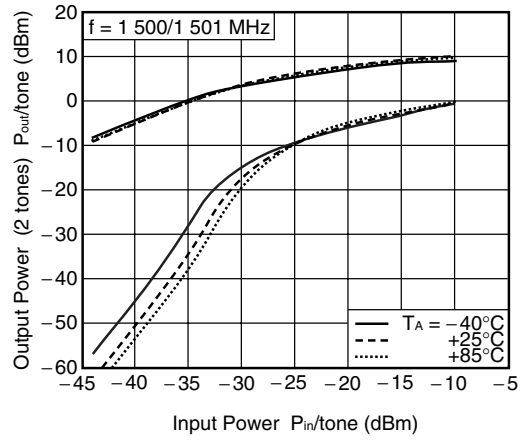

OUTPUT POWER (2 TONES)
vs. INPUT POWER

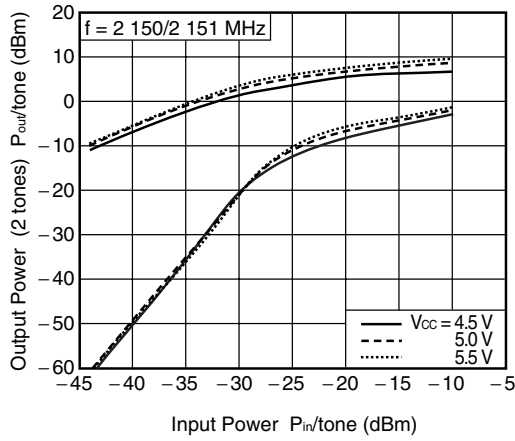

OUTPUT POWER (2 TONES)
vs. INPUT POWER

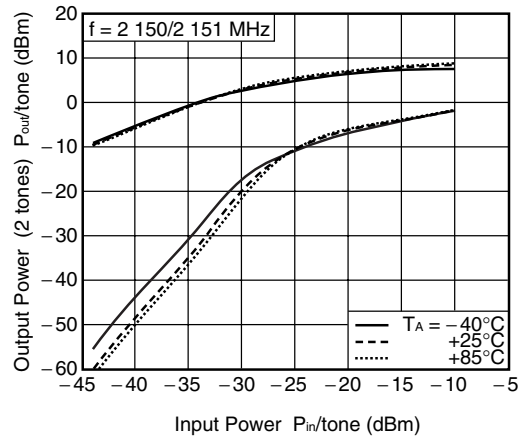

NOISE FIGURE vs. FREQUENCY

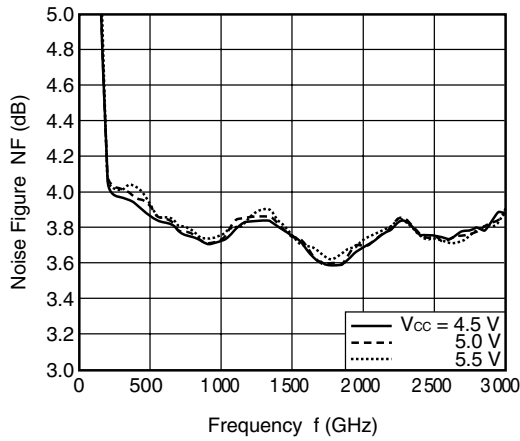

Remark The graphs indicate nominal characteristics.

S-PARAMETERS (T_A = +25°C, V_{CC} = V_{out} = 5.0 V)

S₁₁-FREQUENCY

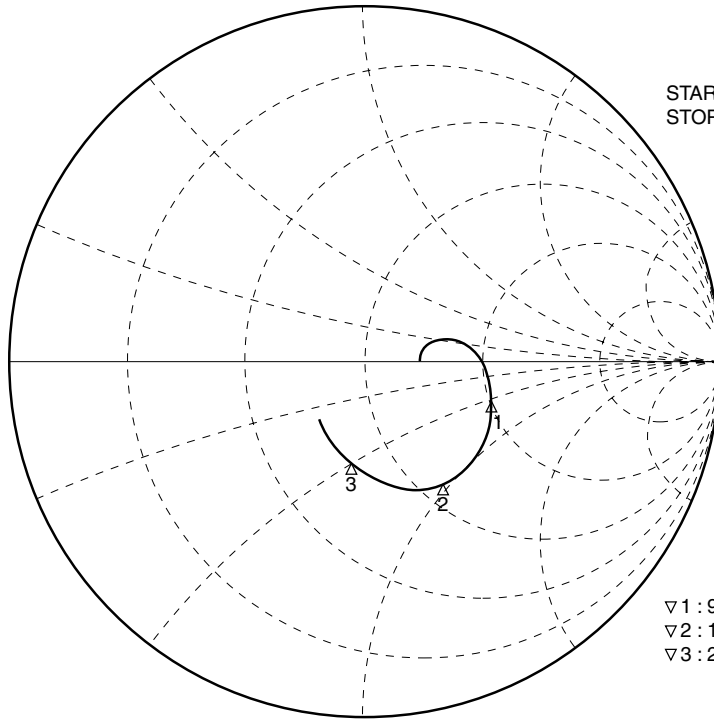

START : 100.000 000 MHz
STOP : 3 000.000 000 MHz

▽1 : 950 MHz	100.41 Ω	-31.537 Ω	5.3124 pF
▽2 : 1 600 MHz	58.686 Ω	-47.725 Ω	2.0843 pF
▽3 : 2 150 MHz	39.938 Ω	-24.401 Ω	3.0338 pF

S₂₂-FREQUENCY

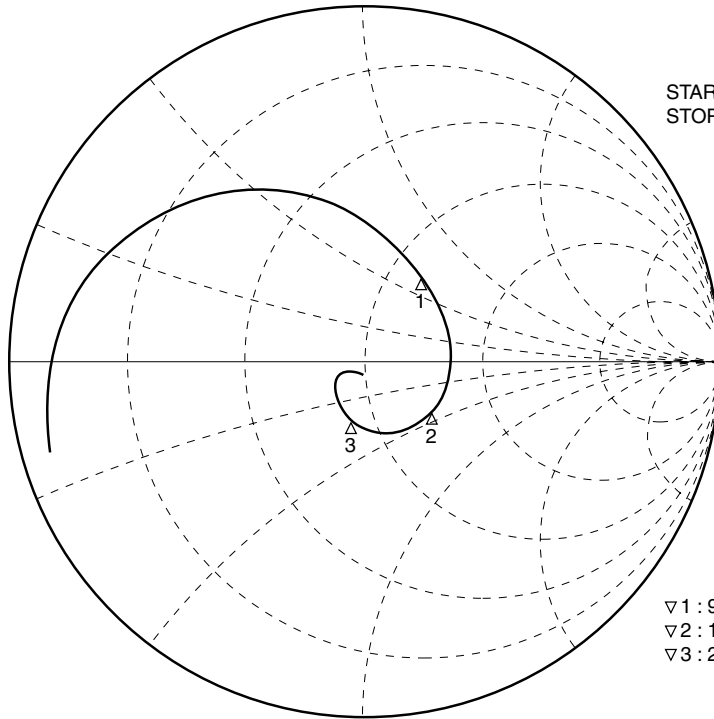

START : 100.000 000 MHz
STOP : 3 000.000 000 MHz

▽1 : 950 MHz	60.637 Ω	32.730 Ω	5.4835 nH
▽2 : 1 600 MHz	70.195 Ω	-20.405 Ω	4.8754 pF
▽3 : 2 150 MHz	44.370 Ω	-14.407 Ω	5.1383 pF

PACKAGE DIMENSIONS

6-PIN SUPER MINIMOLD (UNIT: mm)

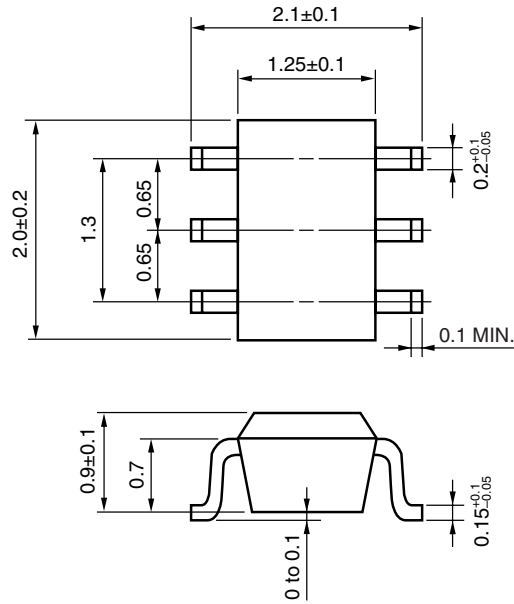

NOTES ON CORRECT USE

- (1) Observe precautions for handling because of electro-static sensitive devices.
- (2) Form a ground pattern as widely as possible to minimize ground impedance (to prevent undesired oscillation).
All the ground pins must be connected together with wide ground pattern to decrease impedance difference.
- (3) The bypass capacitor should be attached to the V_{CC} pin.
- (4) The inductor (L) must be attached between V_{CC} and output pins. The inductance value should be determined in accordance with desired frequency.
- (5) The DC cut capacitor must be attached to input and output pin.

RECOMMENDED SOLDERING CONDITIONS

This product should be soldered and mounted under the following recommended conditions. For soldering methods and conditions other than those recommended below, contact your nearby sales office.

Soldering Method	Soldering Conditions	Condition Symbol
Infrared Reflow	Peak temperature (package surface temperature) : 260°C or below Time at peak temperature : 10 seconds or less Time at temperature of 220°C or higher : 60 seconds or less Preheating time at 120 to 180°C : 120±30 seconds Maximum number of reflow processes : 3 times Maximum chlorine content of rosin flux (% mass) : 0.2%(Wt.) or below	IR260
Wave Soldering	Peak temperature (molten solder temperature) : 260°C or below Time at peak temperature : 10 seconds or less Preheating temperature (package surface temperature) : 120°C or below Maximum number of flow processes : 1 time Maximum chlorine content of rosin flux (% mass) : 0.2%(Wt.) or below	WS260
Partial Heating	Peak temperature (terminal temperature) : 350°C or below Soldering time (per side of device) : 3 seconds or less Maximum chlorine content of rosin flux (% mass) : 0.2%(Wt.) or below	HS350

Caution Do not use different soldering methods together (except for partial heating).

- **The information in this document is current as of December, 2004. The information is subject to change without notice. For actual design-in, refer to the latest publications of NEC's data sheets or data books, etc., for the most up-to-date specifications of NEC semiconductor products. Not all products and/or types are available in every country. Please check with an NEC sales representative for availability and additional information.**
 - No part of this document may be copied or reproduced in any form or by any means without prior written consent of NEC. NEC assumes no responsibility for any errors that may appear in this document.
 - NEC does not assume any liability for infringement of patents, copyrights or other intellectual property rights of third parties by or arising from the use of NEC semiconductor products listed in this document or any other liability arising from the use of such products. No license, express, implied or otherwise, is granted under any patents, copyrights or other intellectual property rights of NEC or others.
 - Descriptions of circuits, software and other related information in this document are provided for illustrative purposes in semiconductor product operation and application examples. The incorporation of these circuits, software and information in the design of customer's equipment shall be done under the full responsibility of customer. NEC assumes no responsibility for any losses incurred by customers or third parties arising from the use of these circuits, software and information.
 - While NEC endeavours to enhance the quality, reliability and safety of NEC semiconductor products, customers agree and acknowledge that the possibility of defects thereof cannot be eliminated entirely. To minimize risks of damage to property or injury (including death) to persons arising from defects in NEC semiconductor products, customers must incorporate sufficient safety measures in their design, such as redundancy, fire-containment, and anti-failure features.
 - NEC semiconductor products are classified into the following three quality grades:
"Standard", "Special" and "Specific". The "Specific" quality grade applies only to semiconductor products developed based on a customer-designated "quality assurance program" for a specific application. The recommended applications of a semiconductor product depend on its quality grade, as indicated below. Customers must check the quality grade of each semiconductor product before using it in a particular application.
 - "Standard": Computers, office equipment, communications equipment, test and measurement equipment, audio and visual equipment, home electronic appliances, machine tools, personal electronic equipment and industrial robots
 - "Special": Transportation equipment (automobiles, trains, ships, etc.), traffic control systems, anti-disaster systems, anti-crime systems, safety equipment and medical equipment (not specifically designed for life support)
 - "Specific": Aircraft, aerospace equipment, submersible repeaters, nuclear reactor control systems, life support systems and medical equipment for life support, etc.
- The quality grade of NEC semiconductor products is "Standard" unless otherwise expressly specified in NEC's data sheets or data books, etc. If customers wish to use NEC semiconductor products in applications not intended by NEC, they must contact an NEC sales representative in advance to determine NEC's willingness to support a given application.
- (Note)
- (1) "NEC" as used in this statement means NEC Corporation, NEC Compound Semiconductor Devices, Ltd. and also includes its majority-owned subsidiaries.
 - (2) "NEC semiconductor products" means any semiconductor product developed or manufactured by or for NEC (as defined above).

M8E 00.4-0110

► For further information, please contact

NEC Compound Semiconductor Devices, Ltd. <http://www.ncsd.necel.com/>

E-mail: salesinfo@ml.ncsd.necel.com (sales and general)

techinfo@ml.ncsd.necel.com (technical)

Sales Division TEL: +81-44-435-1588 FAX: +81-44-435-1579

NEC Compound Semiconductor Devices Hong Kong Limited

E-mail: ncsd-hk@elhk.nec.com.hk (sales, technical and general)

Hong Kong Head Office TEL: +852-3107-7303 FAX: +852-3107-7309

Taipei Branch Office TEL: +886-2-8712-0478 FAX: +886-2-2545-3859

Korea Branch Office TEL: +82-2-558-2120 FAX: +82-2-558-5209

NEC Electronics (Europe) GmbH <http://www.ee.nec.de/>

TEL: +49-211-6503-0 FAX: +49-211-6503-1327

California Eastern Laboratories, Inc. <http://www.cel.com/>

TEL: +1-408-988-3500 FAX: +1-408-988-0279

0406