

### FEATURES

- **2.8 dB NOISE FIGURE**
- **LOW VOLTAGE - LOW CURRENT:** 6 mA at 3 V
- **LOW POWER CONSUMPTION:** 18 mW TYP
- **SUPER SMALL PACKAGE**
- **TAPE AND REEL PACKAGING OPTION AVAILABLE**

### DESCRIPTION

The UPC2748T is a Silicon Monolithic integrated circuit which is manufactured using the NESAT III process. The NESAT III process produces transistors with  $f_T$  approaching 20 GHz. This amplifier was designed for 900 MHz receivers in cellular and cordless telephone applications. Operating on a 3 volt supply (1.8 volt minimum) this IC is ideally suited for hand-held, portable designs.

NEC's stringent quality assurance and test procedures ensure the highest reliability and performance.

**NOISE FIGURE AND GAIN vs. FREQUENCY**  
 $V_{CC} = 3.0 \text{ V}$ ,  $I_{CC} = 6 \text{ mA}$

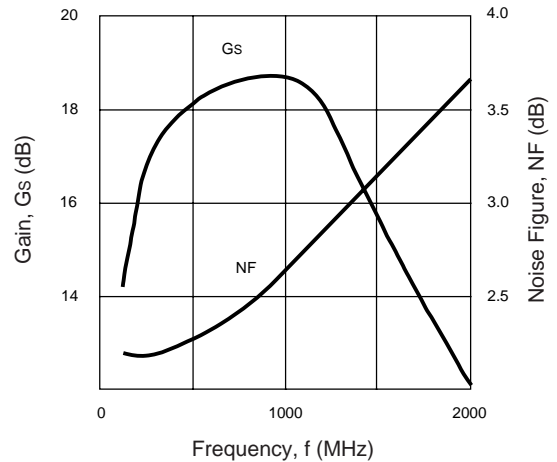

### ELECTRICAL CHARACTERISTICS ( $T_A = 25^\circ\text{C}$ , $Z_L = Z_S = 50 \Omega$ )

PART NUMBER PACKAGE OUTLINE			UPC2748T TO6		
SYMBOLS	PARAMETERS AND CONDITIONS	UNITS	MIN	TYP	MAX
$I_{CC}$	Circuit Current (no signal) $V_{CC} = 3.0 \text{ V}$ $V_{CC} = 1.8 \text{ V}$	mA mA	4.5	6.0 3.5	8.0
$G_s$	Small Signal Gain, $f = 900 \text{ MHz}$ , $V_{CC} = 3.0 \text{ V}$ $f = 900 \text{ MHz}$ , $V_{CC} = 1.8 \text{ V}$	dB dB	16	19 11.5	21
$f_{L1}$	Lower Limit Operating Frequency, $V_{CC} = 3.0 \text{ V}$ $V_{CC} = 1.8 \text{ V}$	GHz GHz		0.2 0.2	0.4
$f_{U2}$	Upper Limit Operating Frequency, $V_{CC} = 3.0 \text{ V}$ $V_{CC} = 1.8 \text{ V}$	GHz GHz	1.2	1.5 1.5	
$P_{SAT}$	Saturated Output Power, $f = 900 \text{ MHz}$ , $V_{CC} = 3.0 \text{ V}$ $f = 900 \text{ MHz}$ , $V_{CC} = 1.8 \text{ V}$	dBm dBm	-6	-3.5 -10	
NF	Noise Figure, $f = 900 \text{ MHz}$ , $V_{CC} = 3.0 \text{ V}$ $f = 900 \text{ MHz}$ , $V_{CC} = 1.8 \text{ V}$	dB dB		2.8 4.5	4.0
$R_{LIN}$	Input Return Loss, $f = 900 \text{ MHz}$ , $V_{CC} = 3.0 \text{ V}$ $f = 900 \text{ MHz}$ , $V_{CC} = 1.8 \text{ V}$	dB dB	8.5	11.5 10	
$R_{LOUT}$	Output Return Loss, $f = 900 \text{ MHz}$ , $V_{CC} = 3.0 \text{ V}$ $f = 900 \text{ MHz}$ , $V_{CC} = 1.8 \text{ V}$	dB dB	5.5	8.5 12	
ISOL	Isolation, $f = 900 \text{ MHz}$ , $V_{CC} = 3.0 \text{ V}$ $f = 900 \text{ MHz}$ , $V_{CC} = 1.8 \text{ V}$	dB dB	35	40 34	
OIP3	SSB Output Third Order Intercept, $f_1 = 500 \text{ MHz}$ , $f_2 = 510 \text{ MHz}$ , $V_{CC} = 3.0 \text{ V}$ $f_1 = 900 \text{ MHz}$ , $f_2 = 902 \text{ MHz}$ , $V_{CC} = 3.0 \text{ V}$ $f_1 = 1000 \text{ MHz}$ , $f_2 = 1010 \text{ MHz}$ , $V_{CC} = 3.0 \text{ V}$ $f_1 = 900 \text{ MHz}$ , $f_2 = 902 \text{ MHz}$ , $V_{CC} = 1.8 \text{ V}$	dBm dBm dBm dBm		-1 -2 -2 -6	
$R_{TH} (J-A)$	Thermal Resistance (Junction to Ambient) Free Air Mounted on a 50 x 50 x 1.6 mm epoxy glass PWB	$^\circ\text{C/W}$ $^\circ\text{C/W}$			620 230

Notes:

1. The gain at  $f_L$  is 3 dB down from the gain at 900 MHz.
2. The gain at  $f_U$  is 3 dB down from the gain at 900 MHz.

**ABSOLUTE MAXIMUM RATINGS<sup>1</sup>** (T<sub>A</sub> = 25°C)

SYMBOLS	PARAMETERS	UNITS	RATINGS
V <sub>CC</sub>	Supply Voltage	V	4.0
I <sub>CC</sub>	Total Supply Current	mA	15
P <sub>IN</sub>	Input Power	dBm	0
P <sub>T</sub>	Total Power Dissipation <sup>2</sup>	mW	280
T <sub>OP</sub>	Operating Temperature	°C	-40 to +85
T <sub>STG</sub>	Storage Temperature	°C	-55 to +150

Notes:

1. Operation in excess of any one of these parameters may result in permanent damage.
2. Mounted on a 50 x 50 x 1.6 mm epoxy glass PWB (T<sub>A</sub> = 85°C).

**RECOMMENDED OPERATING CONDITIONS**

SYMBOLS	PARAMETERS	UNITS	MIN	TYP	MAX
V <sub>CC</sub>	Supply Voltage	V	1.8	3	3.3
T <sub>OP</sub>	Operating Temperature	°C	-40	25	85

**TEST CIRCUIT**

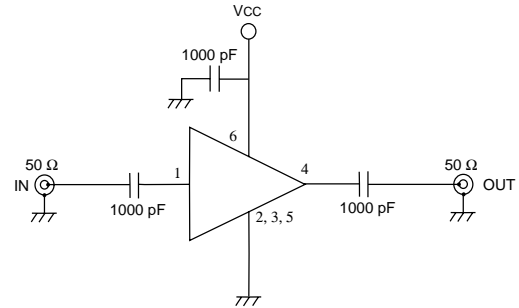

**TYPICAL PERFORMANCE CURVES** (T<sub>A</sub> = 25°C)

**CURRENT vs. SUPPLY VOLTAGE**

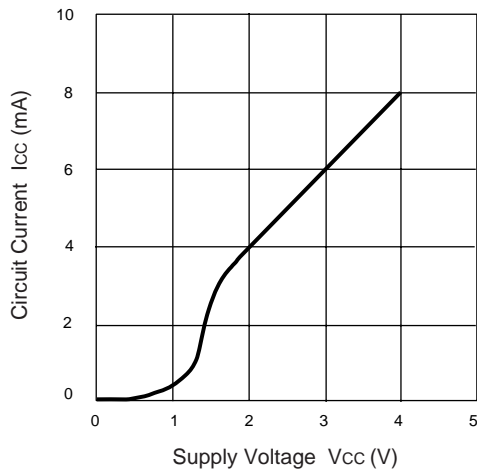

**CURRENT vs. TEMPERATURE**

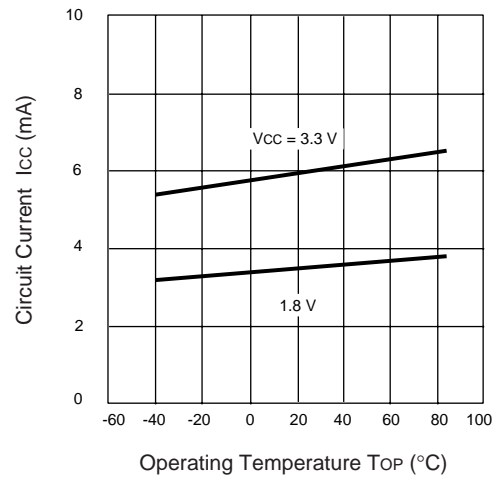

**GAIN vs. FREQUENCY AND TEMPERATURE**

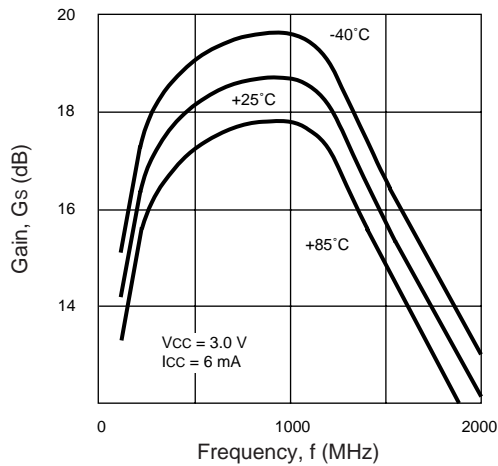

**NOISE FIGURE vs. FREQUENCY**

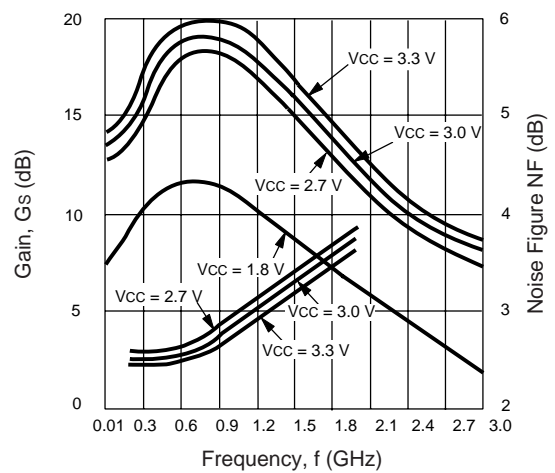

TYPICAL PERFORMANCE CURVES (TA = 25°C)

ISOLATION vs. FREQUENCY

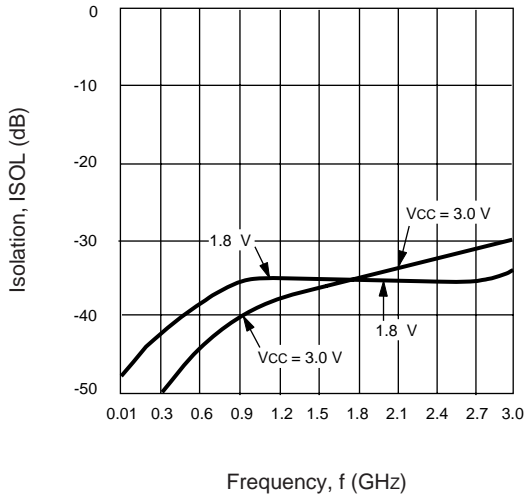

RETURN LOSS vs. FREQUENCY

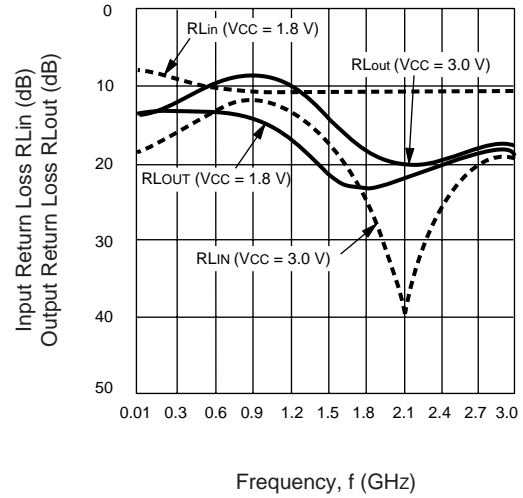

POWER vs. FREQUENCY

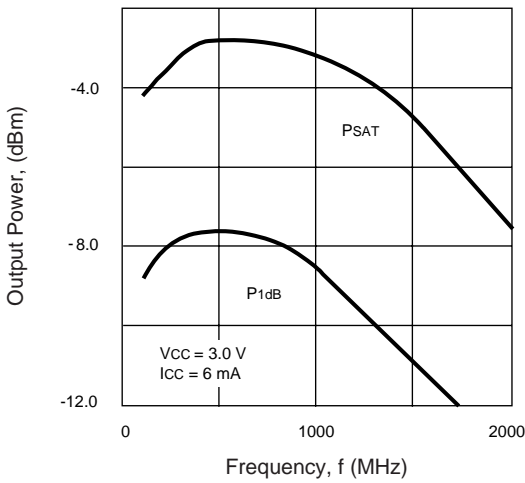

POWER vs. FREQUENCY

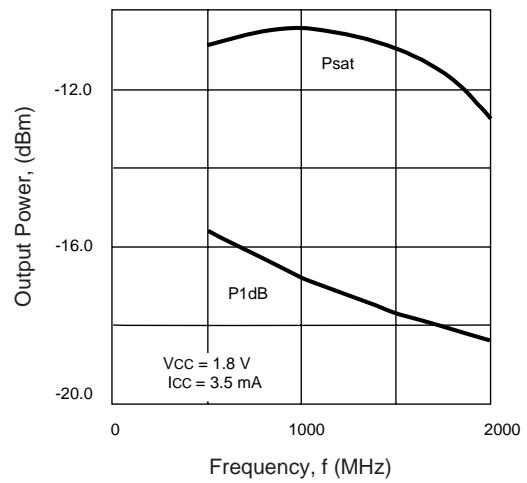

OUTPUT POWER vs. INPUT POWER AND VOLTAGE

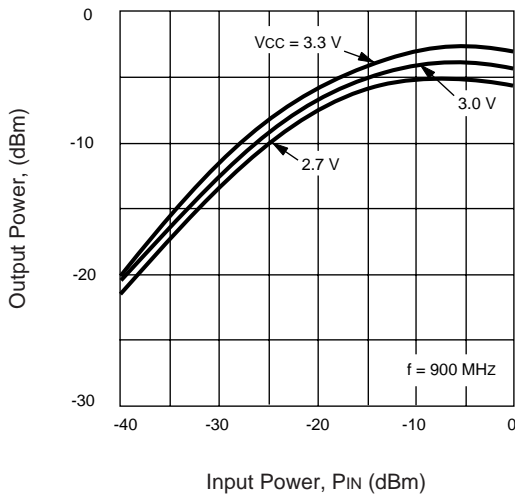

OUTPUT POWER vs. INPUT POWER AND TEMPERATURE

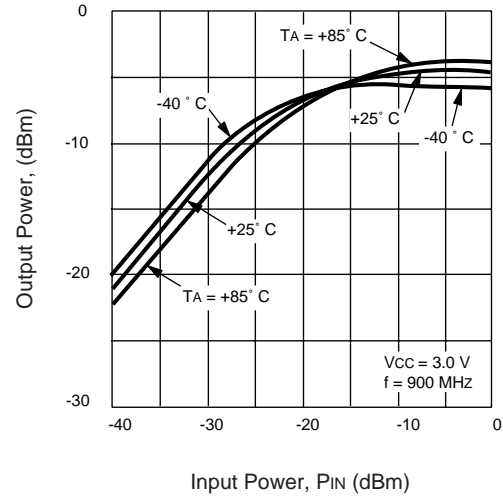

**TYPICAL SCATTERING PARAMETERS** (TA = 25°C)

VCC = 3.0 V, ICC = 6.0 mA

FREQUENCY (GHz)	S11		S21		S12		S22		K1	S21 (dB)
	MAG	ANG	MAG	ANG	MAG	ANG	MAG	ANG		
0.1	0.102	177.8	5.33	5.9	0.001	82.0	0.294	-0.1	84.81	14.5
0.2	0.115	-176.8	6.45	1.0	0.001	98.6	0.310	-4.3	69.14	16.2
0.3	0.138	-177.8	7.11	-10.1	0.002	103.8	0.318	-5.8	31.01	17.0
0.4	0.166	174.7	7.75	-21.3	0.002	110.7	0.325	-7.6	28.05	17.8
0.5	0.185	164.2	8.10	-32.3	0.003	117.3	0.338	-10.1	17.59	18.2
0.6	0.199	150.2	8.44	-44.1	0.004	117.2	0.352	-13.4	12.45	18.5
0.7	0.211	141.1	8.50	-54.4	0.005	115.5	0.364	-17.0	9.74	18.6
0.8	0.207	128.8	8.57	-67.4	0.006	114.4	0.376	-22.7	7.98	18.7
0.9	0.201	111.9	8.64	-79.6	0.008	108.2	0.387	-28.1	5.89	18.7
1.0	0.181	93.4	8.63	-94.0	0.009	101.8	0.392	-36.3	5.26	18.7
1.1	0.166	81.7	8.38	-104.5	0.011	95.2	0.382	-44.3	4.51	18.5
1.2	0.161	71.9	7.71	-115.6	0.011	90.2	0.364	-49.9	4.99	17.7
1.3	0.147	57.4	7.30	-126.6	0.011	88.2	0.344	-57.0	5.37	17.3
1.4	0.131	47.7	6.67	-137.3	0.012	83.9	0.316	-62.4	5.53	16.5
1.5	0.121	37.1	6.21	-146.9	0.011	78.5	0.289	-67.9	6.62	15.9
1.6	0.104	26.8	5.70	-156.0	0.011	79.4	0.262	-72.0	7.36	15.1
1.7	0.096	21.9	5.19	-163.7	0.012	83.7	0.232	-74.6	7.54	14.3
1.8	0.092	16.0	4.74	-171.1	0.013	87.9	0.207	-74.4	7.71	13.5
1.9	0.085	12.7	4.21	-179.0	0.014	90.1	0.176	-71.4	8.18	12.5
2.0	0.060	7.0	3.99	175.3	0.014	89.4	0.159	-65.0	8.71	12.0

VCC = 1.8 V, ICC = 3.5 mA

FREQUENCY (GHz)	S11		S21		S12		S22		K1	S21 (dB)
	MAG	ANG	MAG	ANG	MAG	ANG	MAG	ANG		
0.1	0.497	-9.3	1.99	5.3	0.005	81.3	0.309	-4.1	34.26	6.0
0.2	0.489	-16.0	2.44	-0.8	0.005	77.1	0.315	-9.1	28.13	7.7
0.3	0.470	-23.8	2.81	-13.1	0.006	73.0	0.318	-14.6	20.80	9.0
0.4	0.439	-29.7	3.06	-26.8	0.008	68.9	0.316	-18.9	14.86	9.7
0.5	0.420	-34.3	3.18	-41.1	0.010	64.8	0.316	-24.7	11.66	10.0
0.6	0.412	-37.8	3.21	-55.1	0.012	60.7	0.310	-30.5	9.73	10.1
0.7	0.406	-43.0	3.19	-68.3	0.013	56.5	0.297	-36.8	9.16	10.1
0.8	0.413	-47.3	3.07	-81.7	0.015	52.4	0.280	-41.5	8.26	9.7
0.9	0.422	-53.1	2.91	-94.1	0.016	48.3	0.265	-48.4	8.17	9.3
1.0	0.427	-59.0	2.75	-108.1	0.016	43.8	0.240	-53.5	8.71	8.8
1.1	0.431	-66.8	2.58	-119.0	0.017	39.4	0.224	-58.3	8.77	8.2
1.2	0.432	-72.3	2.45	-127.0	0.017	34.9	0.207	-59.0	9.30	7.8
1.3	0.429	-79.5	2.30	-136.2	0.018	30.4	0.191	-63.6	9.45	7.2
1.4	0.423	-85.8	2.17	-145.4	0.018	28.5	0.171	-63.2	10.16	6.7
1.5	0.415	-91.2	2.01	-153.4	0.018	26.7	0.158	-65.8	11.12	6.1
1.6	0.406	-97.7	1.89	-161.5	0.017	24.8	0.142	-64.3	12.70	5.5
1.7	0.393	-103.9	1.78	-169.5	0.016	23.0	0.125	-61.1	14.58	5.0
1.8	0.379	-110.1	1.65	-174.4	0.014	21.1	0.112	-56.9	18.27	4.4
1.9	0.364	-115.7	1.53	178.2	0.013	19.3	0.101	-50.0	21.56	3.7
2.0	0.349	-122.2	1.40	170.8	0.012	17.5	0.093	-45.9	25.89	2.9

Note:

1. K Factor Calculation:

$$K = \frac{1 + |\Delta|^2 - |S_{11}|^2 - |S_{22}|^2}{2 |S_{12} S_{21}|}, \Delta = S_{11} S_{22} - S_{21} S_{12}$$

**OUTLINE DIMENSIONS** (Units in mm)

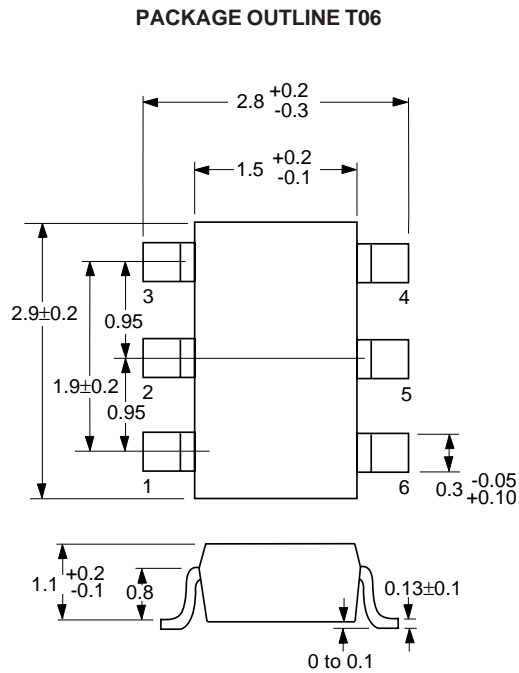

Note:  
All dimensions are typical unless otherwise specified.

**LEAD CONNECTIONS**

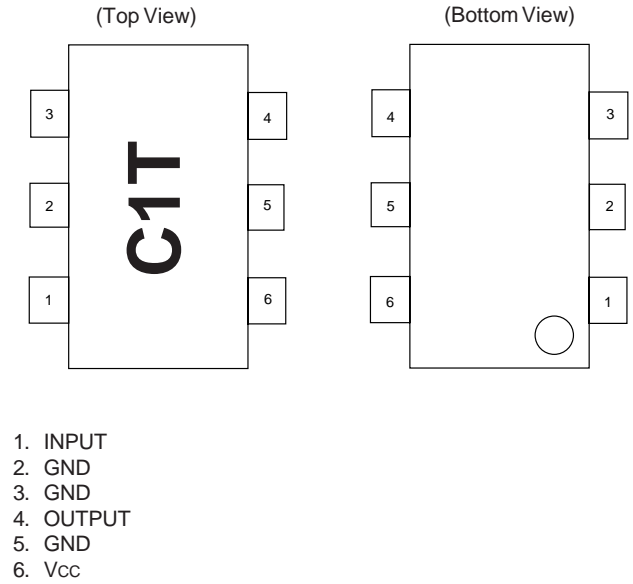

**EQUIVALENT CIRCUIT**

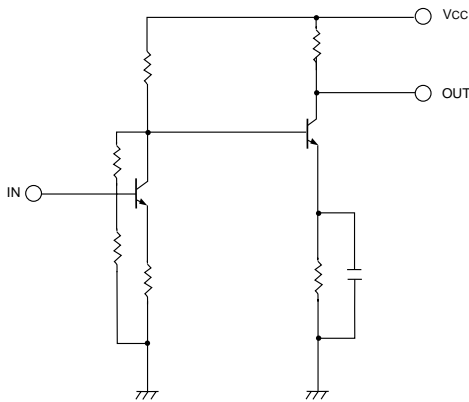

**ORDERING INFORMATION**

PART NUMBER	QTY
UPC2748T-E3	3K/Reel

Note:  
Embossed Tape, 8 mm wide.

**RECOMMENDED P.C.B. LAYOUT** (Units in mm)

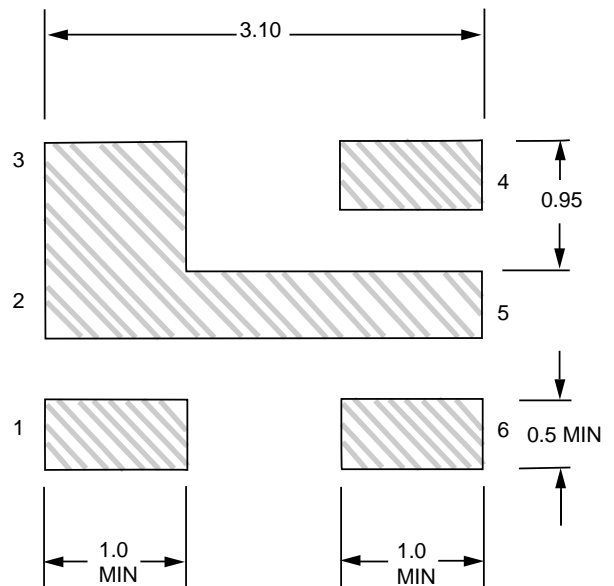

EXCLUSIVE NORTH AMERICAN AGENT FOR **NEC** RF, MICROWAVE & OPTOELECTRONIC SEMICONDUCTORS

**CEL** CALIFORNIA EASTERN LABORATORIES • Headquarters • 4590 Patrick Henry Drive • Santa Clara, CA 95054-1817 • (408) 988-3500 • Telex 34-6393 • FAX (408) 988-0279  
24-Hour Fax-On-Demand: 800-390-3232 (U.S. and Canada only) • Internet: <http://WWW.CEL.COM>

DATA SUBJECT TO CHANGE WITHOUT NOTICE

PRINTED IN USA ON RECYCLED PAPER -11/97