

# BIPOLAR ANALOG INTEGRATED CIRCUITS

# $\mu$ PC2711TB, $\mu$ PC2712TB

## 5 V, SUPER MINIMOLD SILICON MMIC WIDEBAND AMPLIFIER

### DESCRIPTION

The  $\mu$ PC2711TB and  $\mu$ PC2712TB are silicon monolithic integrated circuits designed as buffer amplifier for DBS tuners. These ICs are packaged in super minimold package which is smaller than conventional minimold.

The  $\mu$ PC2711TB and  $\mu$ PC2712TB have each compatible pin connections and performance to  $\mu$ PC2711T/ $\mu$ PC2712T of conventional minimold version. So, in the case of reducing your system size,  $\mu$ PC2711TB/ $\mu$ PC2712TB are suitable to replace from  $\mu$ PC2711T/ $\mu$ PC2712T.

These ICs are manufactured using NEC's 20 GHz fr NESAT™III silicon bipolar process. This process uses silicon nitride passivation film and gold electrodes. These materials can protect chip surface from external pollution and prevent corrosion/migration. Thus, these IC have excellent performance, uniformity and reliability.

### FEATURES

- High-density surface mounting : 6-pin super minimold package (2.0 × 1.25 × 0.9 mm)
- Supply voltage :  $V_{CC} = 4.5$  to  $5.5$  V
- Wideband response :  $f_u = 2.9$  GHz TYP. @ $\mu$ PC2711TB  
 $f_u = 2.6$  GHz TYP. @ $\mu$ PC2712TB
- Power gain variation :  $G_P = 13$  dB TYP. @ $\mu$ PC2711TB  
 $G_P = 20$  dB TYP. @ $\mu$ PC2712TB

### APPLICATIONS

- Local buffer in DBS tuners, etc. :  $\mu$ PC2711TB
- RF stage buffer in DBS tuners, etc. :  $\mu$ PC2712TB

### ORDERING INFORMATION

Part Number	Package	Marking	Supplying Form
$\mu$ PC2711TB-E3	6-pin super minimold	C1G	Embossed tape 8 mm wide. 1, 2, 3 pins face the perforation side of the tape. Qty 3 kpcs/reel.
$\mu$ PC2712TB-E3		C1H	

**Remark** To order evaluation samples, please contact your local NEC sales office (Part number for sample order:  $\mu$ PC2711TB,  $\mu$ PC2712TB).

### Caution Electro-static sensitive devices

The information in this document is subject to change without notice. Before using this document, please confirm that this is the latest version.  
 Not all devices/types available in every country. Please check with local NEC representative for availability and additional information.

**PIN CONNECTIONS**

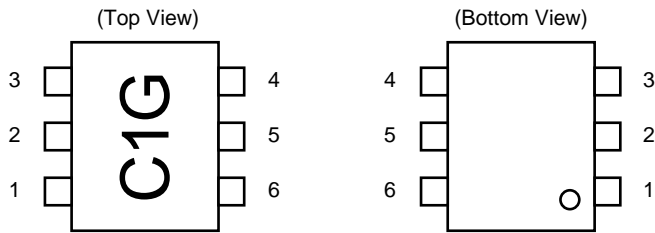

Marking is an example of  $\mu$ PC2711TB

Pin No.	Pin Name
1	INPUT
2	GND
3	GND
4	OUTPUT
5	GND
6	V <sub>CC</sub>

★ **PRODUCT LINE-UP OF 5V-BIAS SILICON MMIC WIDEBAND AMPLIFIERS**

(T<sub>A</sub> = +25°C, V<sub>CC</sub> = 5.0 V, Z<sub>S</sub> = Z<sub>L</sub> = 50 Ω)

Part No.	f <sub>u</sub> (GHz)	P <sub>O(sat)</sub> (dBm)	G <sub>P</sub> (dB)	NF (dB)	I <sub>CC</sub> (mA)	Package	Marking
$\mu$ PC2711T	2.9	+1	13	5.0	12	6-pin minimold	C1G
$\mu$ PC2711TB						6-pin super minimold	
$\mu$ PC2712T	2.6	+3	20	4.5	12	6-pin minimold	C1H
$\mu$ PC2712TB						6-pin super minimold	
$\mu$ PC2713T	1.2	+7.0	29	3.2 @f = 0.5 GHz	12	6-pin minimold	C1J
$\mu$ PC2791TB	1.9	+4.0	12	5.5 @f = 0.5 GHz	17	6-pin super minimold	C2S
$\mu$ PC2792TB	1.2	+5.0	20	3.5 @f = 0.5 GHz	19		C2T
$\mu$ PC3215TB	2.9	+3.5	20.5	2.3 @f = 1.5 GHz	14		C3H

**Remark** Typical performance. Please refer to ELECTRICAL CHARACTERISTICS in detail.

**Caution** The package size distinguish between minimold and super minimold.

**SYSTEM APPLICATION EXAMPLE**

**RF unit block of DBS tuners**

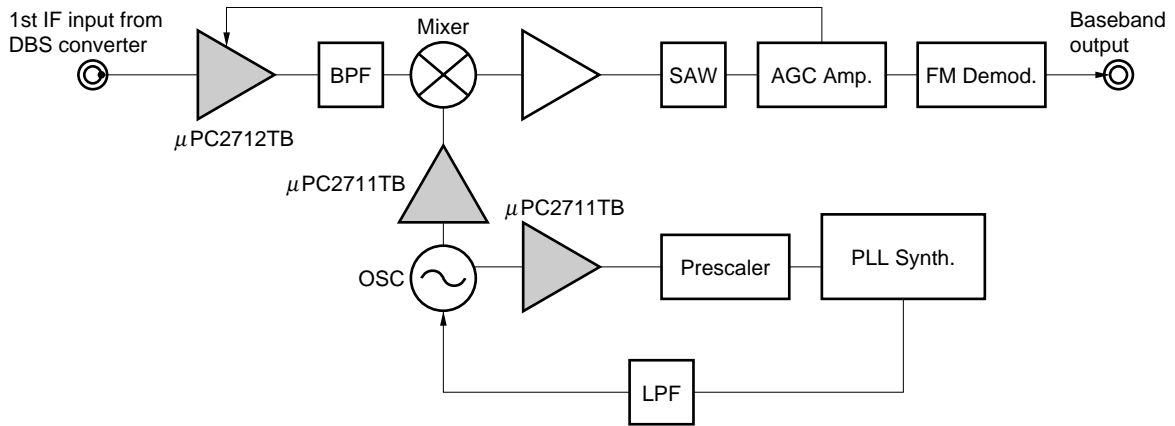

**PIN EXPLANATIONS**

Pin No.	Pin Name	Applied Voltage (V)	Pin Voltage (V) <sup>Note</sup>	Function and Applications	Internal Equivalent Circuit
1	INPUT	—	1.00	Signal input pin. A internal matching circuit, configured with resistors, enables 50 Ω connection over a wide band. A multi-feedback circuit is designed to cancel the deviations of h <sub>FE</sub> and resistance. This pin must be coupled to signal source with capacitor for DC cut.	
			0.97		
4	OUTPUT	—	4.40	Signal output pin. A internal matching circuit, configured with resistors, enables 50 Ω connection over a wide band. This pin must be coupled to next stage with capacitor for DC cut.	
			4.12		
6	V <sub>cc</sub>	4.5 to 5.5	—	Power supply pin. This pin should be externally equipped with bypass capacitor to minimize ground impedance.	
2	GND	0	—	Ground pin. This pin should be connected to system ground with minimum inductance. Ground pattern on the board should be formed as wide as possible. All the ground pins must be connected together with wide ground pattern to decrease impedance difference.	
3					
5					

**Note** Pin voltage is measured at V<sub>cc</sub> = 5.0 V, Above:  $\mu$ PC2711TB, Below:  $\mu$ PC2712TB

**ABSOLUTE MAXIMUM RATINGS**

Parameter	Symbol	Conditions	Ratings	Unit
Supply Voltage	V <sub>CC</sub>	T <sub>A</sub> = +25°C	6	V
Total Circuit Current	I <sub>CC</sub>	T <sub>A</sub> = +25°C	30	mA
★ Power Dissipation	P <sub>D</sub>	Mounted on double sided copper clad 50 × 50 × 1.6 mm epoxy glass PWB (T <sub>A</sub> = +85°C)	270	mW
Operating Ambient Temperature	T <sub>A</sub>		-40 to +85	°C
Storage Temperature	T <sub>stg</sub>		-55 to +150	°C
Input Power	P <sub>in</sub>	T <sub>A</sub> = +25°C	+10	dBm

**RECOMMENDED OPERATING RANGE**

Parameter	Symbol	MIN.	TYP.	MAX.	Unit
Supply Voltage	V <sub>CC</sub>	4.5	5.0	5.5	V
Operating Ambient Temperature	T <sub>A</sub>	-40	+25	+85	°C

**ELECTRICAL CHARACTERISTICS (T<sub>A</sub> = +25°C, V<sub>CC</sub> = 5.0 V, Z<sub>S</sub> = Z<sub>L</sub> = 50 Ω)**

Parameter	Symbol	Test Conditions	$\mu$ PC2711TB			$\mu$ PC2712TB			Unit
			MIN.	TYP.	MAX.	MIN.	TYP.	MAX.	
Circuit Current	I <sub>CC</sub>	No signal	9	12	15	9	12	15	mA
Power Gain	G <sub>P</sub>	f = 1 GHz	11	13	16.5	18	20	23.5	dB
Saturated Output Power	P <sub>O(sat)</sub>	f = 1 GHz, P <sub>in</sub> = 0 dBm	-2	+1	—	0	+3	—	dBm
Noise Figure	NF	f = 1 GHz	—	5	6.5	—	4.5	6	dB
Upper Limit Operating Frequency	f <sub>u</sub>	3 dB down below from gain at f = 0.1 GHz	2.7	2.9	—	2.2	2.6	—	GHz
Isolation	ISL	f = 1 GHz	25	30	—	28	33	—	dB
Input Return Loss	RL <sub>in</sub>	f = 1 GHz	20	25	—	9	12	—	dB
Output Return Loss	RL <sub>out</sub>	f = 1 GHz	9	12	—	10	13	—	dB
★ Gain Flatness	ΔG <sub>P</sub>	f = 0.1 to 2.5 GHz @ $\mu$ PC2711TB f = 0.1 to 2.0 GHz @ $\mu$ PC2712TB	—	±0.8	—	—	±0.8	—	dB

TEST CIRCUIT

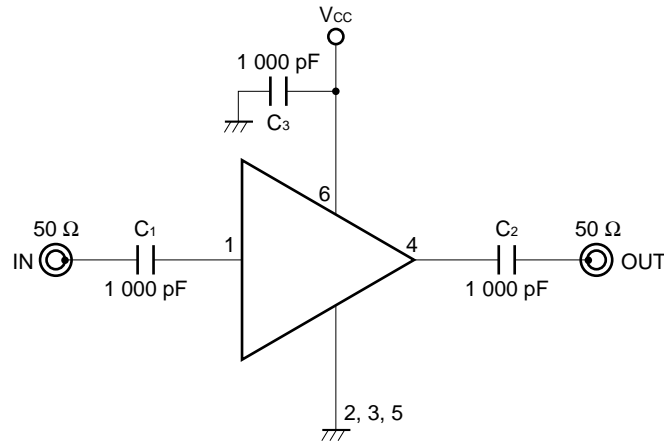

EXAMPLE OF APPLICATION CIRCUIT

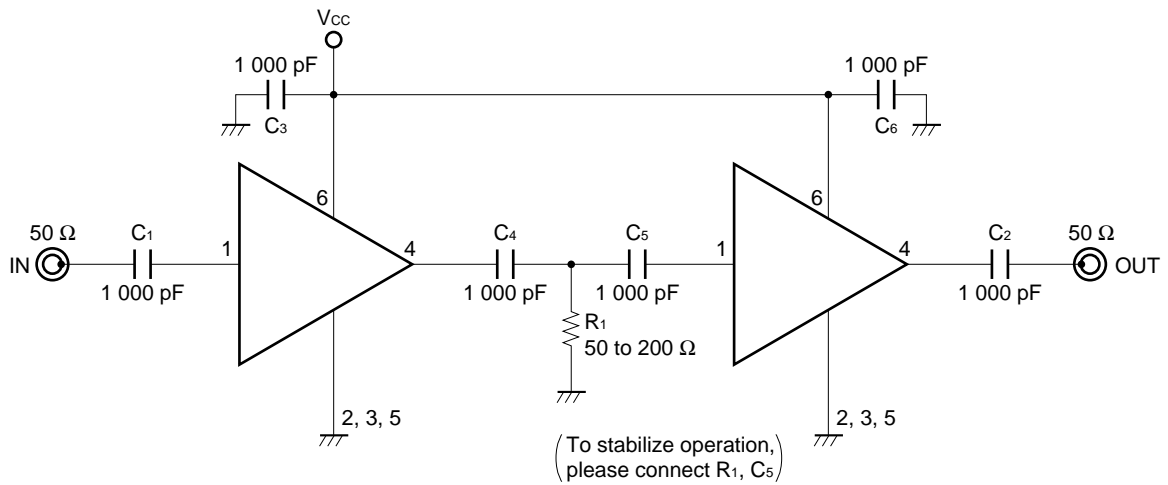

The application circuits and their parameters are for references only and are not intended for use in actual design-ins.

CAPACITORS FOR V<sub>CC</sub>, INPUT AND OUTPUT PINS

1 000 pF capacitors are recommendable as bypass capacitor for V<sub>CC</sub> pin and coupling capacitors for input/output pins.

Bypass capacitor for V<sub>CC</sub> pin is intended to minimize V<sub>CC</sub> pin's ground impedance. Therefore, stable bias can be supplied against V<sub>CC</sub> fluctuation.

Coupling capacitors for input/output pins are intended to minimize RF serial impedance and cut DC.

To get flat gain from 100 MHz up, 1 000 pF capacitors are assembled on the test circuit. [Actually, 1 000 pF capacitors give flat gain at least 10 MHz. In the case of under 10 MHz operation, increase the value of coupling capacitor such as 2 200 pF. Because the coupling capacitors are determined by the equation of  $C = 1/(2 \pi fZ_s)$ .]

ILLUSTRATION OF THE TEST CIRCUIT ASSEMBLED ON EVALUATION BOARD

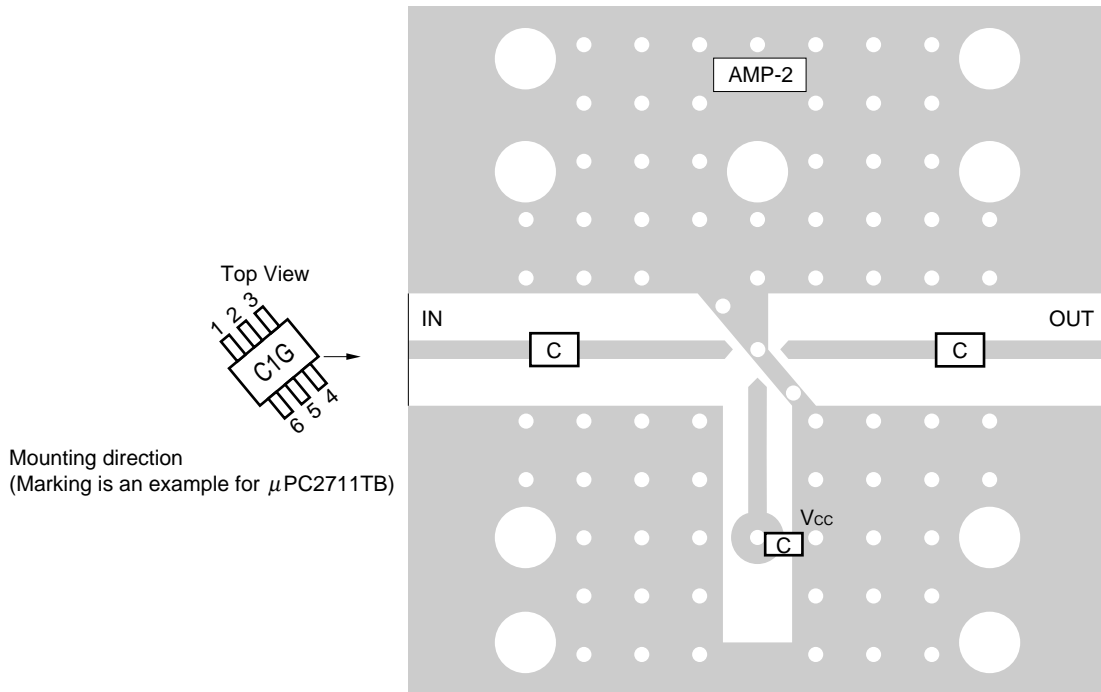

COMPONENT LIST

	Value
C	1 000 pF

Notes

1. 30 × 30 × 0.4 mm double sided copper clad polyimide board.
2. Back side: GND pattern
3. Solder plated on pattern
4. ○: Through holes

For more information on the use of this IC, refer to the following application note: **USAGE AND APPLICATIONS OF 6-PIN MINI-MOLD, 6-PIN SUPER MINI-MOLD SILICON HIGH-FREQUENCY WIDEBAND AMPLIFIER MMIC (P11976E).**

TYPICAL CHARACTERISTICS (Unless otherwise specified,  $T_A = +25^\circ\text{C}$ )

—  $\mu$ PC2711TB —

CIRCUIT CURRENT vs. SUPPLY VOLTAGE

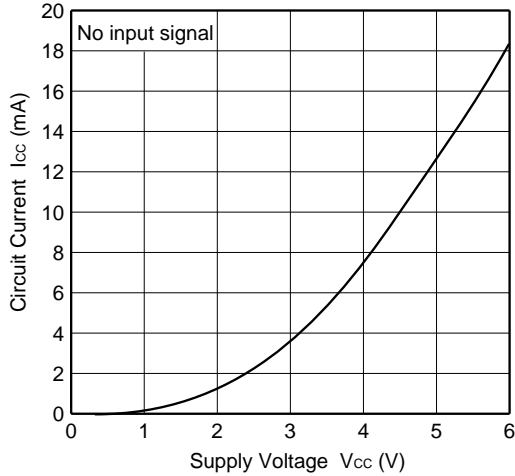

CIRCUIT CURRENT vs. OPERATING AMBIENT TEMPERATURE

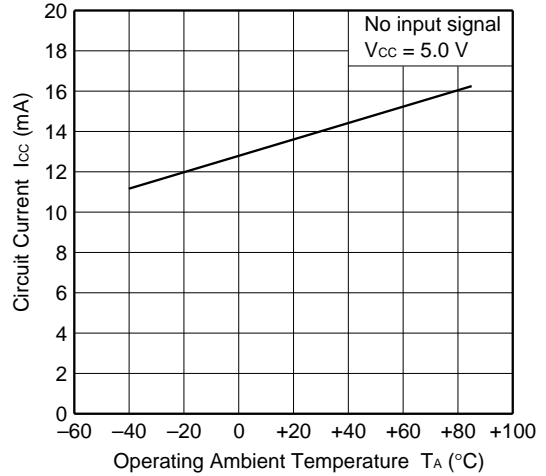

NOISE FIGURE, POWER GAIN vs. FREQUENCY

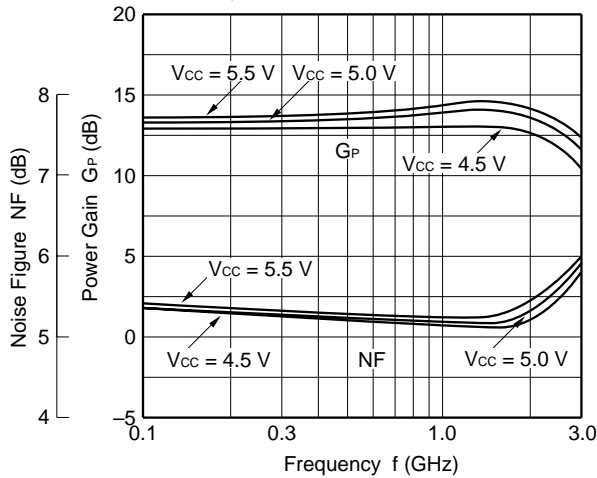

POWER GAIN vs. FREQUENCY

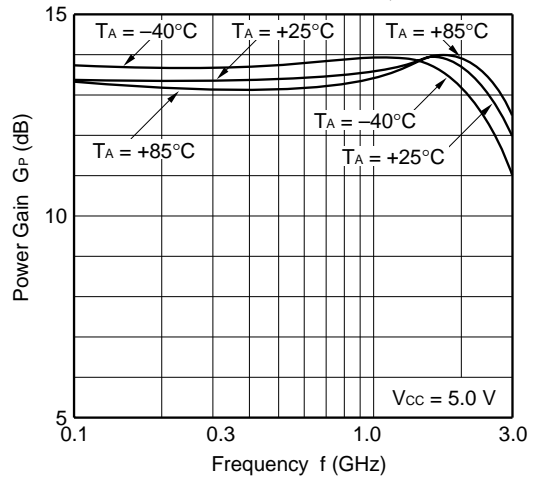

ISOLATION vs. FREQUENCY

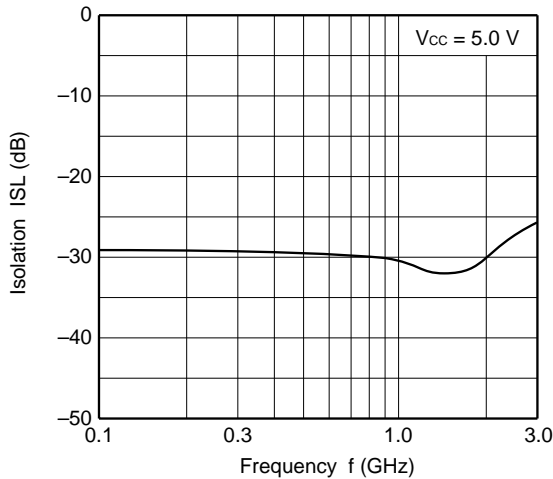

INPUT RETURN LOSS, OUTPUT RETURN LOSS vs. FREQUENCY

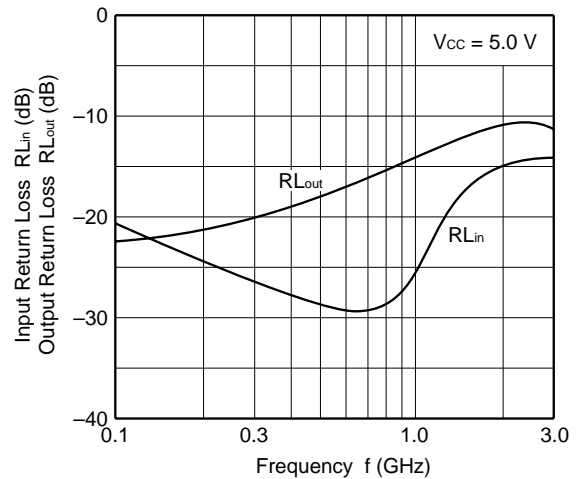

—  $\mu$ PC2711TB —

OUTPUT POWER vs. INPUT POWER

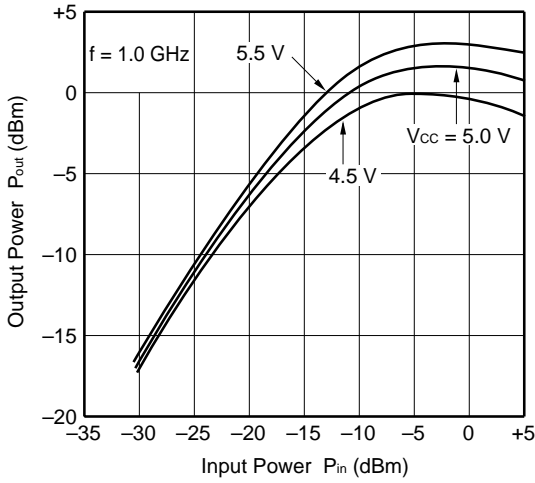

OUTPUT POWER vs. INPUT POWER

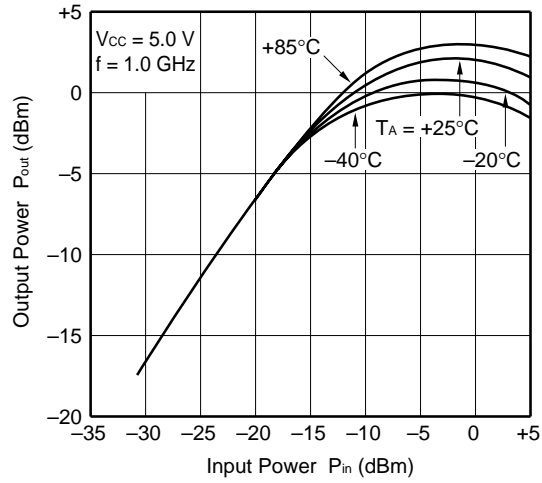

OUTPUT POWER vs. INPUT POWER

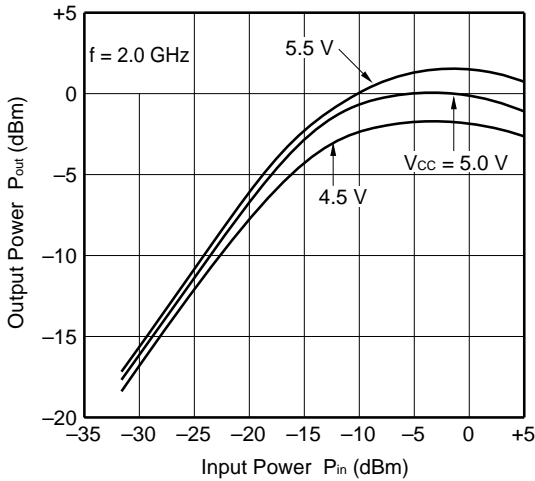

OUTPUT POWER vs. INPUT POWER

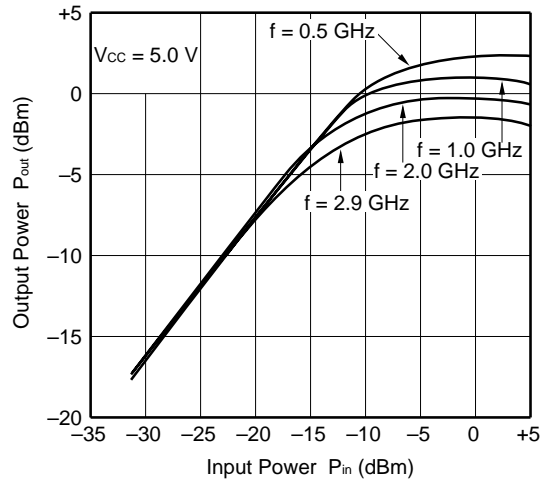

SATURATED OUTPUT POWER vs. FREQUENCY

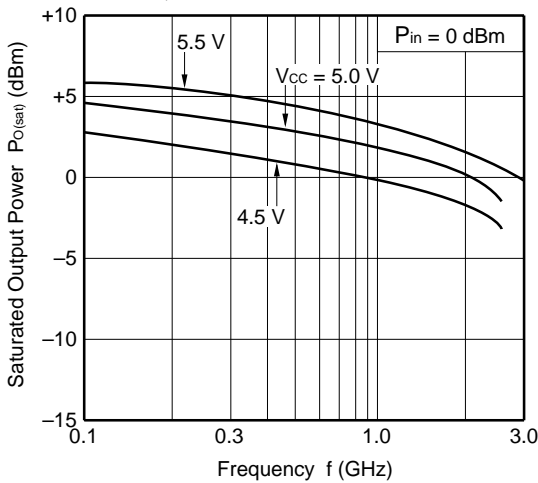

3RD ORDER INTERMODULATION DISTORTION vs. OUTPUT POWER OF EACH TONE

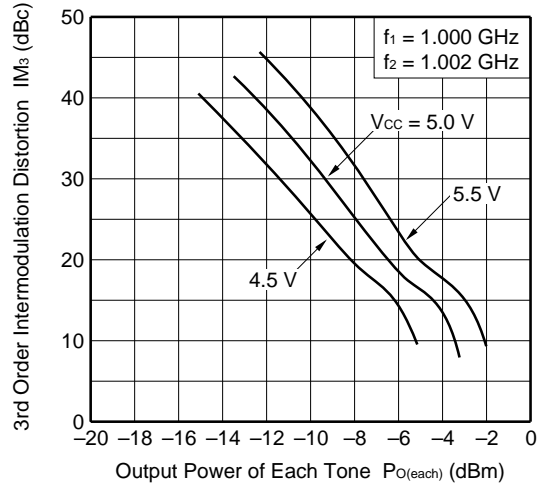

**Remark** The graphs indicate nominal characteristics.



S-PARAMETERS ( $T_A = +25^\circ\text{C}$ ,  $V_{CC} = 5.0\text{ V}$ )

—  $\mu$ PC2711TB —

S<sub>11</sub>-FREQUENCY

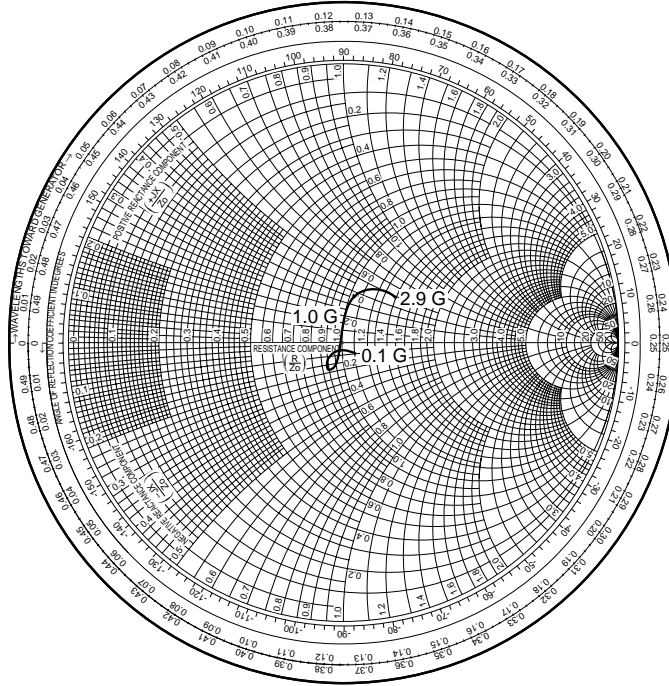

S<sub>22</sub>-FREQUENCY

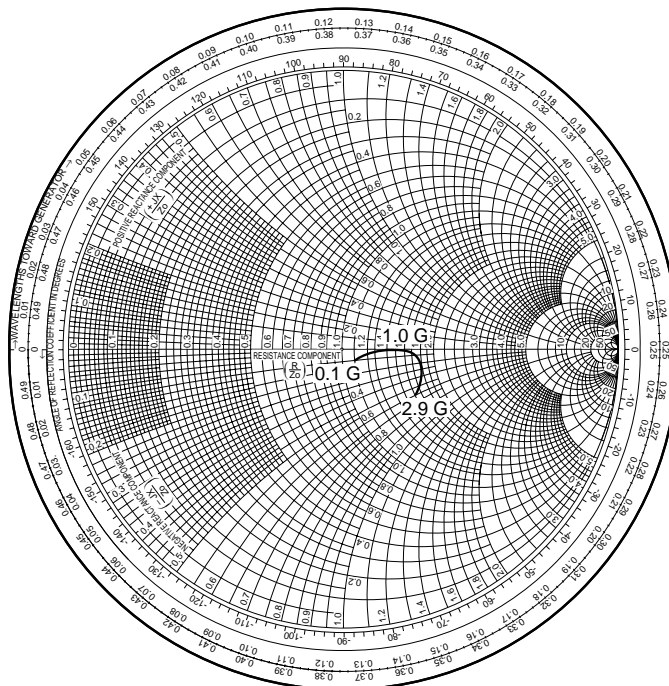

TYPICAL S-PARAMETER VALUES (T<sub>A</sub> = +25°C)

μPC2711TB

V<sub>CC</sub> = 5.0 V, I<sub>CC</sub> = 13.8 mA

FREQUENCY MHz	S <sub>11</sub>		S <sub>21</sub>		S <sub>12</sub>		S <sub>22</sub>		K
	MAG.	ANG.	MAG.	ANG.	MAG.	ANG.	MAG.	ANG.	
100.0000	0.085	-22.4	4.447	-14.9	0.035	-12.7	0.113	-3.1	3.18
200.0000	0.086	-25.0	4.468	-30.1	0.035	-23.0	0.119	1.2	3.21
300.0000	0.098	-29.2	4.491	-44.9	0.034	-32.1	0.136	1.6	3.23
400.0000	0.081	-29.4	4.510	-60.3	0.033	-42.5	0.142	6.5	3.34
500.0000	0.066	-33.9	4.540	-74.9	0.033	-50.1	0.156	10.1	3.32
600.0000	0.041	-54.5	4.572	-90.2	0.033	-59.6	0.161	12.7	3.34
700.0000	0.053	-104.3	4.624	-105.3	0.032	-69.3	0.161	8.8	3.33
800.0000	0.070	-119.7	4.664	-120.7	0.031	-78.4	0.176	6.2	3.36
900.0000	0.098	-121.9	4.729	-136.1	0.032	-86.6	0.192	1.9	3.27
1000.0000	0.101	-112.5	4.781	-152.0	0.031	-94.9	0.228	0.1	3.29
1100.0000	0.090	-108.5	4.843	-167.9	0.031	-103.9	0.256	-0.6	3.15
1200.0000	0.060	-95.6	4.945	175.8	0.029	-111.0	0.290	-1.1	3.24
1300.0000	0.019	-79.2	4.999	159.5	0.029	-120.2	0.308	-0.3	3.16
1400.0000	0.023	54.8	5.062	143.0	0.028	-128.9	0.322	-1.4	3.18
1500.0000	0.062	80.7	5.114	126.4	0.029	-133.1	0.327	-2.2	3.08
1600.0000	0.087	80.4	5.142	109.5	0.029	-140.9	0.333	-4.8	3.07
1700.0000	0.113	78.7	5.160	92.7	0.029	-146.2	0.344	-7.0	3.02
1800.0000	0.126	72.0	5.146	75.4	0.030	-151.4	0.356	-9.7	2.88
1900.0000	0.154	63.5	5.123	58.0	0.032	-159.7	0.371	-11.1	2.70
2000.0000	0.178	59.0	5.113	41.3	0.035	-168.3	0.378	-12.0	2.51
2100.0000	0.212	54.2	5.063	24.0	0.036	-175.7	0.383	-12.8	2.39
2200.0000	0.232	55.2	5.006	6.9	0.038	175.2	0.378	-13.6	2.27
2300.0000	0.246	53.8	4.954	-10.4	0.041	165.2	0.367	-16.1	2.13
2400.0000	0.248	53.6	4.865	-27.7	0.045	155.3	0.359	-18.0	1.99
2500.0000	0.240	49.2	4.783	-45.0	0.048	143.6	0.356	-21.1	1.88
2600.0000	0.238	43.7	4.664	-62.3	0.049	131.2	0.359	-23.6	1.85
2700.0000	0.240	36.2	4.529	-79.6	0.052	119.8	0.366	-26.2	1.76
2800.0000	0.262	31.7	4.384	-96.6	0.054	108.7	0.374	-28.6	1.72
2900.0000	0.285	28.8	4.255	-113.1	0.056	95.5	0.372	-31.1	1.68
3000.0000	0.316	29.7	4.117	-129.6	0.057	83.6	0.361	-35.0	1.69

TYPICAL CHARACTERISTICS (Unless otherwise specified,  $T_A = +25^\circ\text{C}$ )

—  $\mu$ PC2712TB —

CIRCUIT CURRENT vs. SUPPLY VOLTAGE

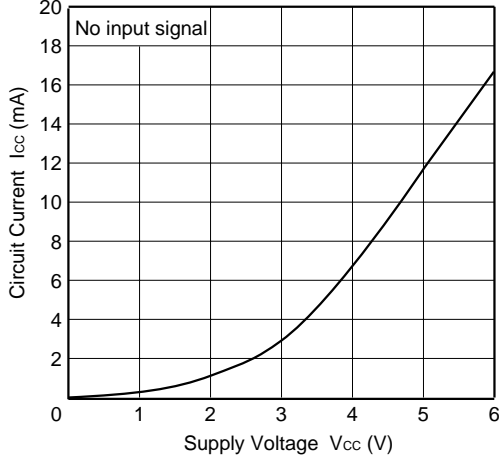

CIRCUIT CURRENT vs. OPERATING AMBIENT TEMPERATURE

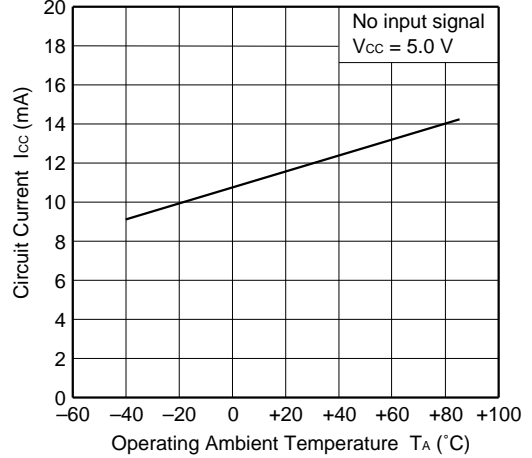

NOISE FIGURE, POWER GAIN vs. FREQUENCY

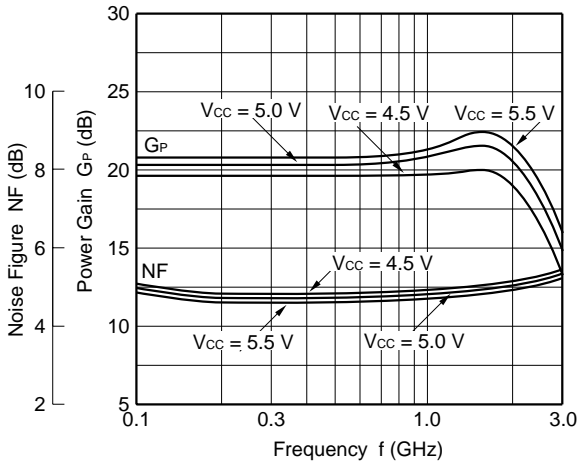

POWER GAIN vs. FREQUENCY

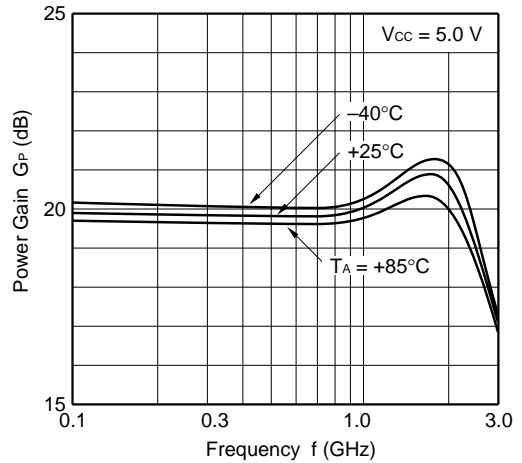

ISOLATION vs. FREQUENCY

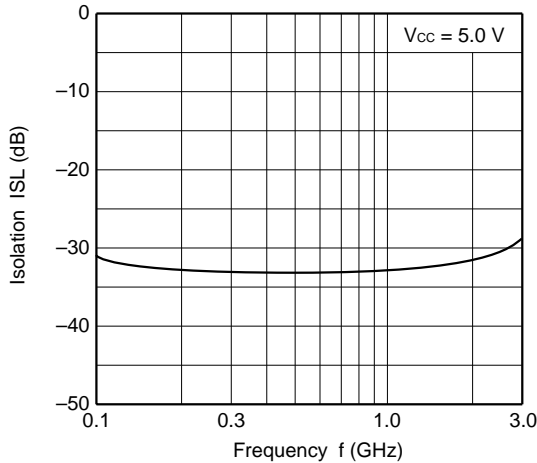

INPUT RETURN LOSS, OUTPUT RETURN LOSS vs. FREQUENCY

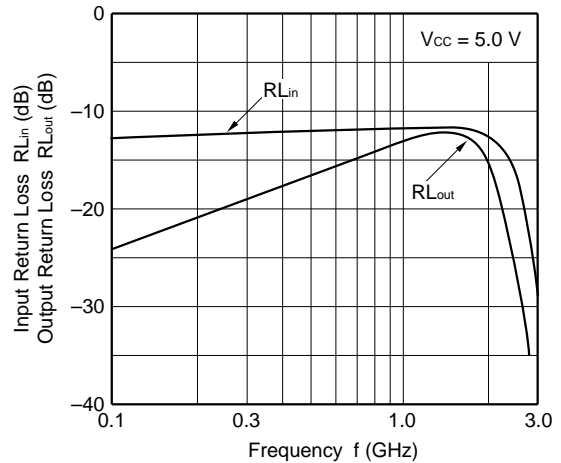

—  $\mu$ PC2712TB —

OUTPUT POWER vs. INPUT POWER

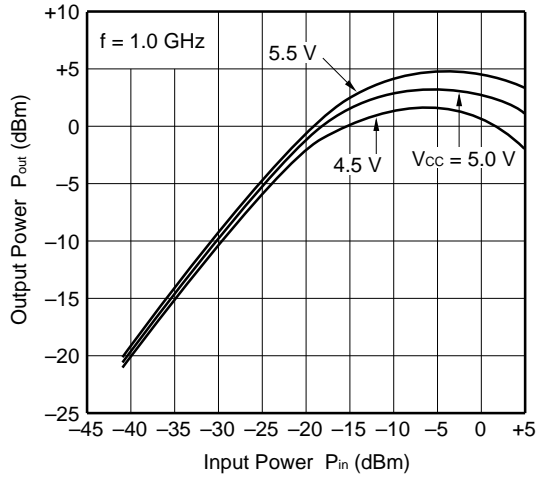

OUTPUT POWER vs. INPUT POWER

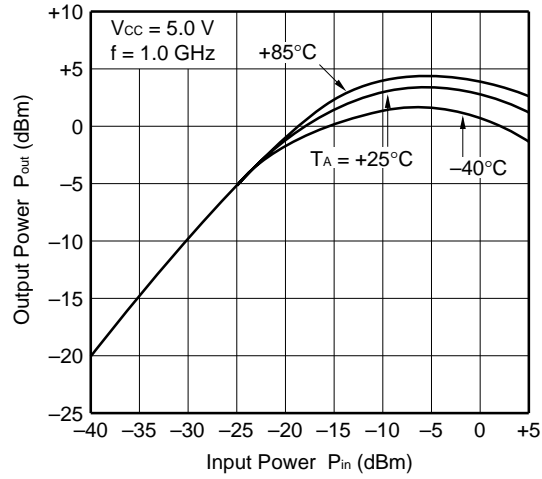

OUTPUT POWER vs. INPUT POWER

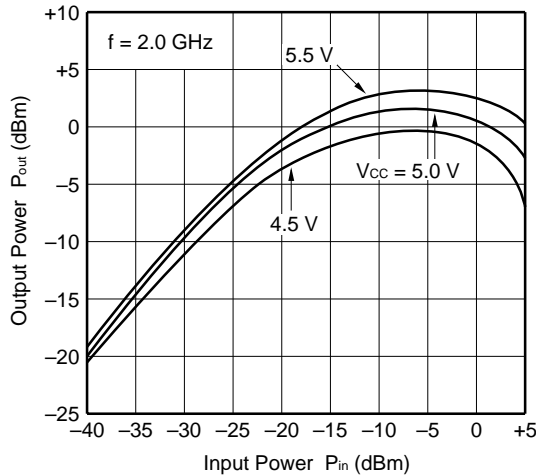

OUTPUT POWER vs. INPUT POWER

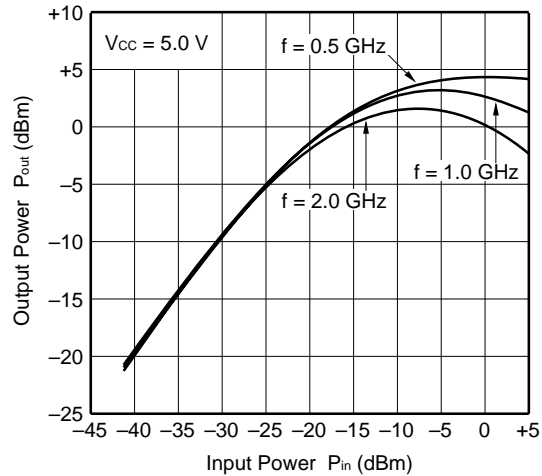

SATURATED OUTPUT POWER vs. FREQUENCY

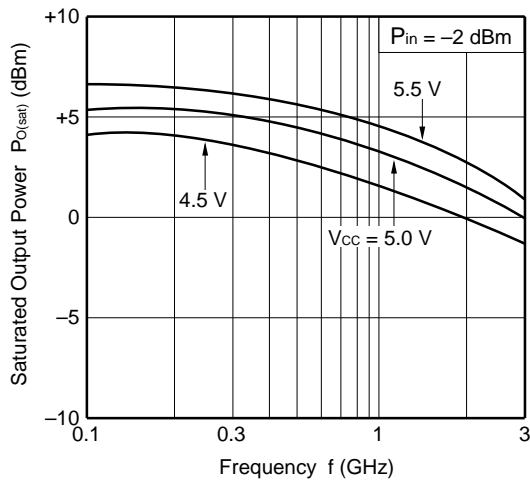

3RD ORDER INTERMODULATION DISTORTION vs. OUTPUT POWER OF EACH TONE

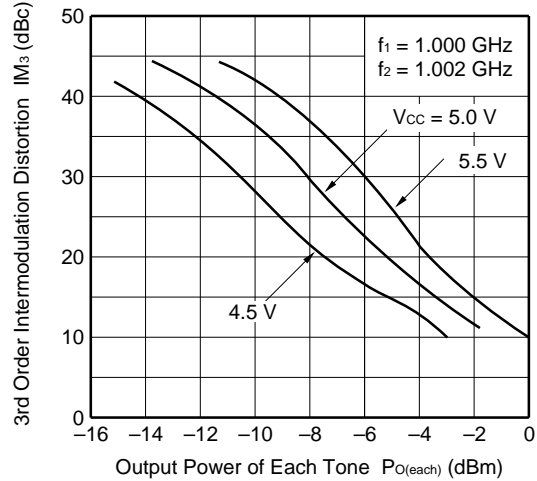

**Remark** The graphs indicate nominal characteristics.

S-PARAMETERS ( $T_A = +25^\circ\text{C}$ ,  $V_{CC} = 5.0\text{ V}$ )

—  $\mu$ PC2712TB —

S<sub>11</sub>-FREQUENCY

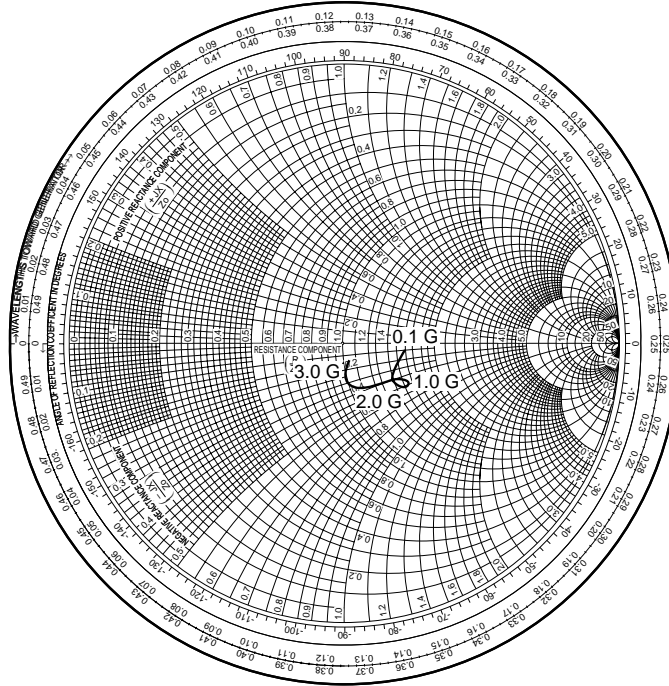

S<sub>22</sub>-FREQUENCY

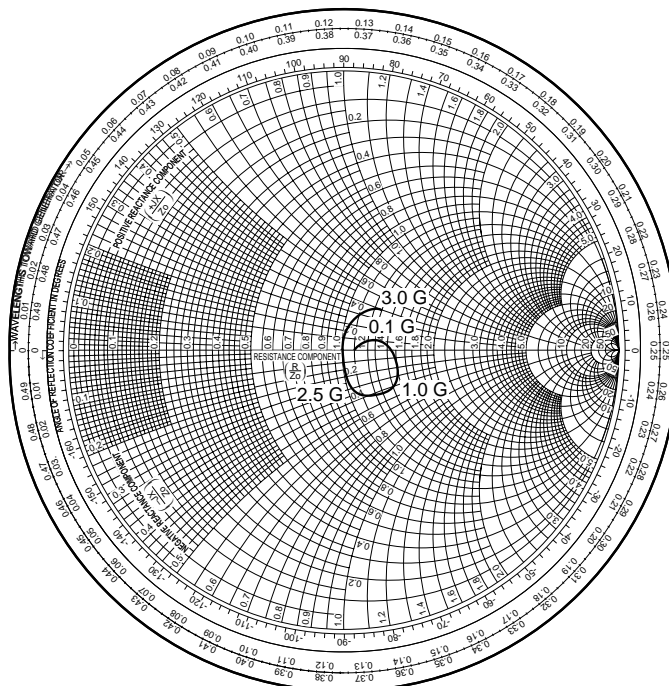

TYPICAL S-PARAMETER VALUES (T<sub>A</sub> = +25°C)

μPC2712TB

V<sub>CC</sub> = 5.0 V, I<sub>CC</sub> = 13.9 mA

FREQUENCY MHz	S <sub>11</sub>		S <sub>21</sub>		S <sub>12</sub>		S <sub>22</sub>		K
	MAG.	ANG.	MAG.	ANG.	MAG.	ANG.	MAG.	ANG.	
100.0000	0.303	-8.1	8.864	-16.7	0.023	-11.4	0.043	2.3	2.32
200.0000	0.291	-10.1	8.827	-33.5	0.023	-19.2	0.055	11.5	2.35
300.0000	0.295	-11.8	8.936	-49.5	0.022	-25.5	0.078	8.5	2.38
400.0000	0.276	-11.3	9.044	-67.6	0.023	-34.6	0.095	13.4	2.33
500.0000	0.265	-11.0	9.051	-82.2	0.023	-42.8	0.112	13.6	2.37
600.0000	0.243	-12.3	9.096	-98.8	0.023	-50.0	0.120	11.1	2.35
700.0000	0.222	-20.3	9.089	-115.2	0.023	-59.8	0.120	1.7	2.37
800.0000	0.219	-25.4	9.080	-131.5	0.023	-66.2	0.136	-6.0	2.38
900.0000	0.230	-33.9	9.096	-147.6	0.023	-73.0	0.155	-14.4	2.39
1000.0000	0.267	-35.5	9.044	-164.2	0.024	-82.9	0.189	-17.5	2.26
1100.0000	0.290	-35.5	9.197	179.5	0.024	-89.5	0.212	-19.9	2.12
1200.0000	0.316	-33.2	9.421	162.4	0.024	-98.4	0.240	-21.4	2.02
1300.0000	0.317	-30.6	9.524	144.9	0.024	-107.0	0.245	-23.2	1.94
1400.0000	0.314	-29.4	9.512	126.6	0.026	-115.7	0.248	-27.1	1.82
1500.0000	0.296	-28.1	9.574	109.1	0.026	-122.3	0.236	-31.8	1.78
1600.0000	0.290	-29.4	9.598	91.1	0.027	-133.2	0.231	-38.0	1.74
1700.0000	0.278	-31.1	9.480	72.9	0.028	-139.4	0.221	-43.8	1.72
1800.0000	0.282	-34.9	9.372	54.3	0.029	-148.1	0.215	-49.8	1.69
1900.0000	0.284	-35.5	9.193	35.6	0.030	-157.6	0.199	-53.0	1.70
2000.0000	0.280	-36.6	9.198	18.4	0.031	-167.4	0.170	-55.3	1.69
2100.0000	0.273	-36.0	9.011	0.1	0.033	-175.1	0.134	-56.2	1.68
2200.0000	0.244	-38.2	8.784	-17.9	0.033	176.5	0.090	-55.2	1.74
2300.0000	0.222	-40.0	8.717	-35.1	0.034	164.8	0.050	-53.7	1.74
2400.0000	0.189	-45.7	8.388	-52.9	0.036	154.8	0.025	1.8	1.75
2500.0000	0.177	-52.9	8.217	-70.1	0.037	143.5	0.039	33.4	1.74
2600.0000	0.164	-57.4	7.890	-87.4	0.039	133.3	0.071	39.3	1.72
2700.0000	0.158	-59.6	7.597	-104.6	0.041	123.8	0.099	34.3	1.70
2800.0000	0.143	-53.9	7.313	-121.4	0.041	114.0	0.131	26.0	1.72
2900.0000	0.128	-44.3	7.078	-138.4	0.043	101.4	0.149	22.8	1.70
3000.0000	0.111	-22.2	6.806	-154.9	0.046	90.2	0.157	19.4	1.70

★ PACKAGE DIMENSIONS

6-PIN SUPER MINIMOLD (UNIT : mm)

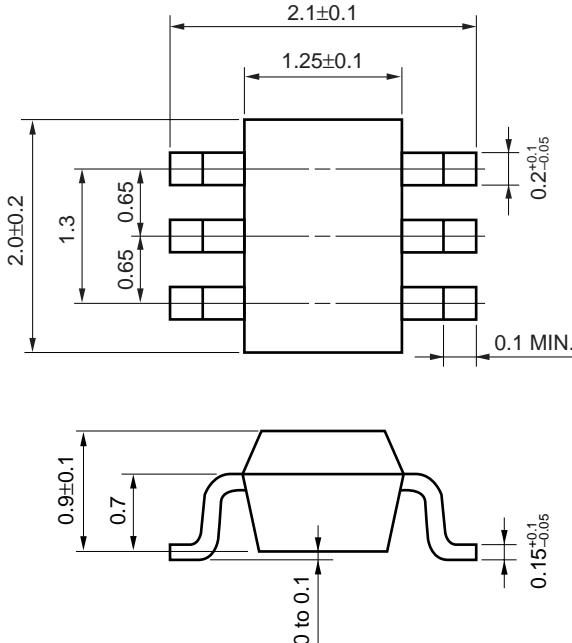

**NOTES ON CORRECT USE**

- (1) Observe precautions for handling because of electro-static sensitive devices.
- (2) Form a ground pattern as wide as possible to minimize ground impedance (to prevent undesired oscillation).  
All the ground pins must be connected together with wide ground pattern to decrease impedance difference.
- (3) The bypass capacitor should be attached to Vcc line.
- (4) The DC cut capacitor must be each attached to input and output pin.

**RECOMMENDED SOLDERING CONDITIONS**

This product should be soldered in the following recommended conditions. Other soldering methods and conditions than the recommended conditions are to be consulted with our sales representatives.

Soldering Method	Soldering Conditions	Recommended Condition Symbol
Infrared Reflow	Package peak temperature: 235°C or below Time: 30 seconds or less (at 210°C) Count: 3, Exposure limit <sup>Note</sup> : None	IR35-00-3
VPS	Package peak temperature: 215°C or below Time: 40 seconds or less (at 200°C) Count: 3, Exposure limit <sup>Note</sup> : None	VP15-00-3
Wave Soldering	Soldering bath temperature: 260°C or below Time: 10 seconds or less Count: 1, Exposure limit <sup>Note</sup> : None	WS60-00-1
Partial Heating	Pin temperature: 300°C Time: 3 seconds or less (per side of device) Exposure limit <sup>Note</sup> : None	-

**Note** After opening the dry pack, keep it in a place below 25°C and 65% RH for the allowable storage period.

**Caution** Do not use different soldering methods together (except for partial heating).

For details of recommended soldering conditions for surface mounting, refer to information document **SEMICONDUCTOR DEVICE MOUNTING TECHNOLOGY MANUAL (C10535E)**.



[MEMO]

[MEMO]

[MEMO]



## ATTENTION

OBSERVE PRECAUTIONS  
FOR HANDLING  
ELECTROSTATIC  
SENSITIVE  
DEVICES

NESAT (NEC Silicon Advanced Technology) is a trademark of NEC Corporation.

• **The information in this document is current as of November, 2000. The information is subject to change without notice. For actual design-in, refer to the latest publications of NEC's data sheets or data books, etc., for the most up-to-date specifications of NEC semiconductor products. Not all products and/or types are available in every country. Please check with an NEC sales representative for availability and additional information.**

- No part of this document may be copied or reproduced in any form or by any means without prior written consent of NEC. NEC assumes no responsibility for any errors that may appear in this document.
- NEC does not assume any liability for infringement of patents, copyrights or other intellectual property rights of third parties by or arising from the use of NEC semiconductor products listed in this document or any other liability arising from the use of such products. No license, express, implied or otherwise, is granted under any patents, copyrights or other intellectual property rights of NEC or others.
- Descriptions of circuits, software and other related information in this document are provided for illustrative purposes in semiconductor product operation and application examples. The incorporation of these circuits, software and information in the design of customer's equipment shall be done under the full responsibility of customer. NEC assumes no responsibility for any losses incurred by customers or third parties arising from the use of these circuits, software and information.
- While NEC endeavours to enhance the quality, reliability and safety of NEC semiconductor products, customers agree and acknowledge that the possibility of defects thereof cannot be eliminated entirely. To minimize risks of damage to property or injury (including death) to persons arising from defects in NEC semiconductor products, customers must incorporate sufficient safety measures in their design, such as redundancy, fire-containment, and anti-failure features.
- NEC semiconductor products are classified into the following three quality grades:  
"Standard", "Special" and "Specific". The "Specific" quality grade applies only to semiconductor products developed based on a customer-designated "quality assurance program" for a specific application. The recommended applications of a semiconductor product depend on its quality grade, as indicated below. Customers must check the quality grade of each semiconductor product before using it in a particular application.

"Standard": Computers, office equipment, communications equipment, test and measurement equipment, audio and visual equipment, home electronic appliances, machine tools, personal electronic equipment and industrial robots

"Special": Transportation equipment (automobiles, trains, ships, etc.), traffic control systems, anti-disaster systems, anti-crime systems, safety equipment and medical equipment (not specifically designed for life support)

"Specific": Aircraft, aerospace equipment, submersible repeaters, nuclear reactor control systems, life support systems and medical equipment for life support, etc.

The quality grade of NEC semiconductor products is "Standard" unless otherwise expressly specified in NEC's data sheets or data books, etc. If customers wish to use NEC semiconductor products in applications not intended by NEC, they must contact an NEC sales representative in advance to determine NEC's willingness to support a given application.

(Note)

- (1) "NEC" as used in this statement means NEC Corporation and also includes its majority-owned subsidiaries.
- (2) "NEC semiconductor products" means any semiconductor product developed or manufactured by or for NEC (as defined above).

M8E 00.4