

# Low Power Dual Operational Amplifier

**IL358**

The IL358 contains two independent high gain operational amplifiers with internal frequency compensation. The two op-amps operate over a wide voltage range from a single power supply. Also use a split power supply. The device has low power supply current drain, regardless of the power supply voltage. The low power drain also makes the IL358 a good choice for battery operation.

When your project calls for a traditional op-amp function, now you can streamline your design with a simple single power supply. Use ordinary +5VDC common to practically any digital system or personal computer application, without requiring an extra 15V power supply just to have the interface electronics you need.

The IL358 is a versatile, rugged workhorse with a thousand-and-one uses, from amplifying signals from a variety of transducers to dc gain blocks, or any op-amp function. The attached pages offer some recipes that will have your project cooking in no time.

- Internally frequency compensated for unity gain
- Large DC voltage gain: 100dB
- Wide power supply range:  
3V ~ 32V (or  $\pm 1.5V \sim \pm 16V$ )
- Input common-mode voltage range includes ground
- Large output voltage swing: 0V DC to  $V_{CC}-1.5V$  DC
- Power drain suitable for battery operation
- Low input offset voltage and offset current
- Differential input voltage range equal to the power supply voltage
- Possible to exchange the position of Pin9 for Pin1 because of Pin Connection being symmetric (IL358S only)

**N SUFFIX PLASTIC**

**D SUFFIX SOIC**

**SIP-9**

**SIP-8**

**ORDERING INFORMATION**  
 IL358N Plastic  
 IL358D SOIC  
 IL358S-9 SIP-9  
 IL358S SIP-8  
 $T_A = -40^\circ$  to  $85^\circ C$   
 for all packages.

## LOGIC DIAGRAM

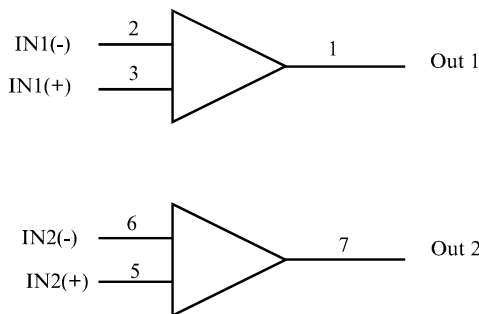

PIN 4 = GND  
 PIN 8 =  $V_{CC}$

## PIN ASSIGNMENT

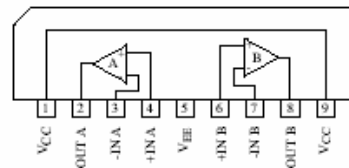
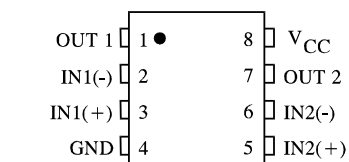

**MAXIMUM RATINGS\***

Symbol	Parameter	Value	Unit
V <sub>CC</sub>	Power Supply Voltages		
	Single Supply Split Supplies	32 ±16	V
V <sub>IDR</sub>	Input Differential Voltage Range (1)	±32	V
V <sub>ICR</sub>	Input Common Mode Voltage Range	-0.3 to 32	V
I <sub>SC</sub>	Output Short Circuit Duration	Continuous	
T <sub>J</sub>	Junction Temperature		
	Plastic Packages	150	°C
T <sub>stg</sub>	Storage Temperature		
	Plastic Packages	-55 to +125	°C
I <sub>IN</sub>	Input Current, per pin (2)	50	mA
T <sub>L</sub>	Lead Temperature, 1mm from Case for 10 Seconds	260	°C

\*Maximum Ratings are those values beyond which damage to the device may occur. Functional operation should be restricted to the Recommended Operating Conditions.

+Derating - Plastic DIP: - 10 mW/°C from 65° to 125°C

SOIC Package: - 7 mW/°C from 65° to 125°C

Notes:

1. Split Power Supplies.
2. V<sub>IN</sub><-0.3V. This input current will only exist when voltage at any of the input leads is driven negative.

**RECOMMENDED OPERATING CONDITIONS**

Symbol	Parameter	Min	Max	Unit
V <sub>CC</sub>	DC Supply Voltage	±2.5 or 5.0	±15 or 30	V
T <sub>A</sub>	Operating Temperature, All Package Types	-40	+85	°C

This device contains protection circuitry to guard against damage due to high static voltages or electric fields. However, precautions must be taken to avoid applications of any voltage higher than maximum rated voltages to this high-impedance circuit. For proper operation, V<sub>IN</sub> and V<sub>OUT</sub> should be constrained to the range GND ≤ (V<sub>IN</sub> or V<sub>OUT</sub>) ≤ V<sub>CC</sub>.

Unused inputs must always be tied to an appropriate logic voltage level (e.g., either GND or V<sub>CC</sub>). Unused outputs must be left open.

DC ELECTRICAL CHARACTERISTICS (T<sub>A</sub>=-40 to +85°C)

Symbol	Parameter	Test Conditions	Guaranteed Limit			Unit
			Min	Typ	Max	
V <sub>IO</sub>	Maximum Input Offset Voltage	V <sub>O</sub> =1.4V V <sub>CC</sub> =5.0-30V;R <sub>S</sub> =0Ω V <sub>ICM</sub> =0V to V <sub>CC</sub> -1.7V			9.0 5.0*	mV
ΔV <sub>IO</sub> /ΔT	Input Offset Voltage Drift	R <sub>S</sub> =0Ω, V <sub>CC</sub> =30V		7.0		μV/°C
I <sub>IO</sub>	Maximum Input Offset Current	V <sub>CC</sub> =5.0V			150 50*	nA
ΔI <sub>IO</sub> /ΔT	Input Offset Current Drift	R <sub>S</sub> =0Ω, V <sub>CC</sub> =30V		10		pA/°C
I <sub>IB</sub>	Maximum Input Bias Current	V <sub>CC</sub> =5.0V			500 250*	nA
V <sub>ICR</sub>	Input Common Mode Voltage Range	V <sub>CC</sub> =30V	0		28	V
I <sub>CC</sub>	Maximum Power Supply Current	R <sub>L</sub> =∞, V <sub>CC</sub> =30V, V <sub>O</sub> =0V R <sub>L</sub> =∞, V <sub>CC</sub> =5V, V <sub>O</sub> =0V			3 1.2	mA
A <sub>VOL</sub>	Minimum Large Signal Open-Loop Voltage Gain	V <sub>CC</sub> =15V, R <sub>L</sub> ≥2KΩ	15 25*			V/mV
V <sub>OH</sub>	Minimum Output High-Level Voltage Swing	V <sub>CC</sub> =30V, R <sub>L</sub> =2KΩ V <sub>CC</sub> =30V, R <sub>L</sub> =10KΩ	26 27			V
V <sub>OL</sub>	Maximum Output Low-Level Voltage Swing	V <sub>CC</sub> =5V, R <sub>L</sub> =10KΩ			20	mV
CMR	Common Mode Rejection	V <sub>CC</sub> =30V, R <sub>S</sub> =10KΩ	65*			dB
PSR	Power Supply Rejection	V <sub>CC</sub> =30V	65*			dB
CS	Channel Separation	f=1KHz to 20KHz, V <sub>CC</sub> =30V	-120*			dB
I <sub>SC</sub>	Maximum Output Short Circuit to GND	V <sub>CC</sub> =5.0V V <sub>O</sub> =0V			60*	mA
I <sub>source</sub>	Minimum Source Output Current	V <sub>IN+</sub> =1V, V <sub>IN-</sub> =0V, V <sub>CC</sub> =15V, V <sub>O</sub> =2V	10			mA
I <sub>sink</sub>	Minimum Output Sink Current	V <sub>IN+</sub> =0V, V <sub>IN-</sub> =1V, V <sub>CC</sub> =15V, V <sub>O</sub> =2V V <sub>IN+</sub> =0V, V <sub>IN-</sub> =1V, V <sub>CC</sub> =15V, V <sub>O</sub> =0.2V	5 10* 12*			mA μA
V <sub>IDR</sub>	Differential Input Voltage Range	All V <sub>IN</sub> ≥GND or V-Supply (if used)			V <sub>CC</sub> *	V

\*=@25°C

TYPICAL PERFORMANCE CHARACTERISTICS

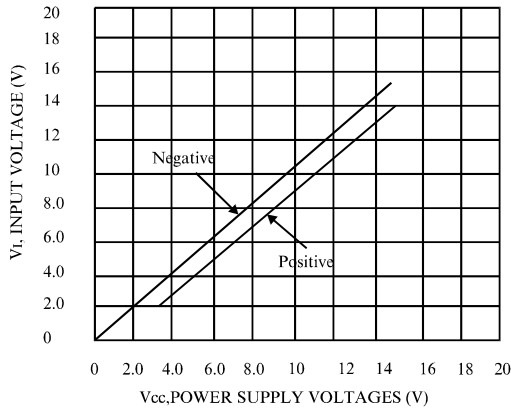

Figure 1. Input Voltage Range

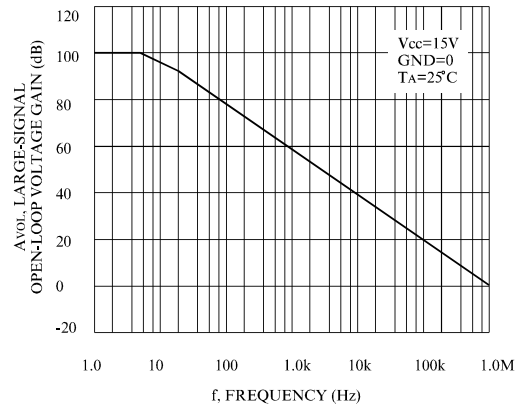

Figure 2. Open-Loop Frequency

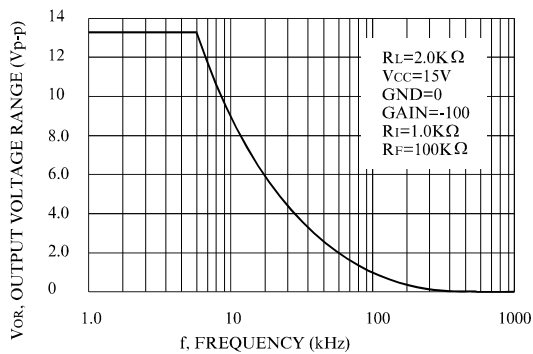

Figure 3. Large-Signal Frequency Response

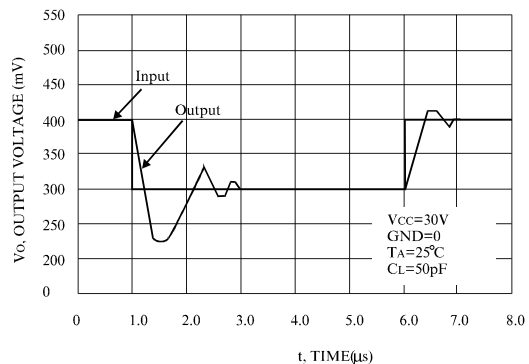

Figure 4. Small-Signal Voltage Follower Pulse Response (Noninverting)

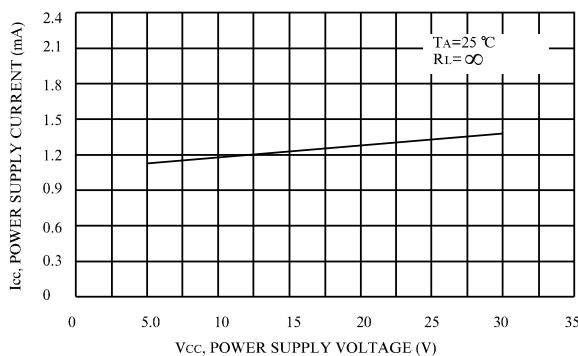

Figure 5. Power Supply Current versus Power Supply Voltage

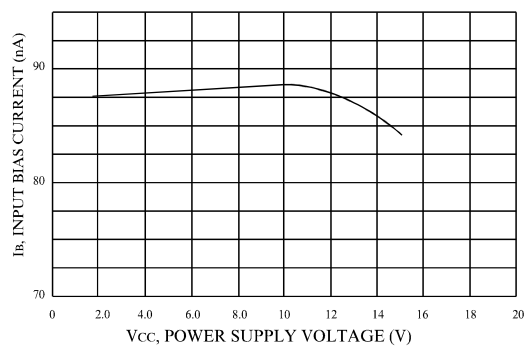
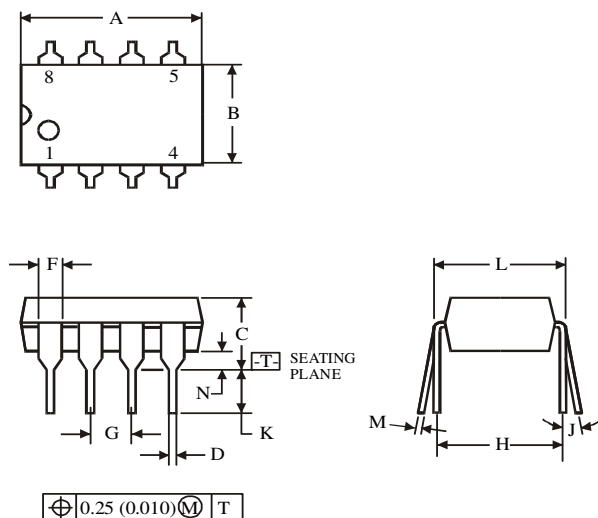
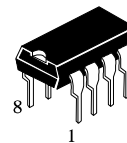

Figure 6. Input Bias Current versus Power Supply Voltage

PACKAGE DIMENSIONS

N SUFFIX PLASTIC DIP  
(MS - 001BA)



Symbol	Dimension, mm	
	MIN	MAX
A	8.51	10.16
B	6.1	7.11
C		5.33
D	0.36	0.56
F	1.14	1.78
G	2.54	
H	7.62	
J	0°	10°
K	2.92	3.81
L	7.62	8.26
M	0.2	0.36
N	0.38	

NOTES:

- Dimensions "A", "B" do not include mold flash or protrusions.  
Maximum mold flash or protrusions 0.25 mm (0.010) per side.

D SUFFIX SOIC  
(MS - 012AA)

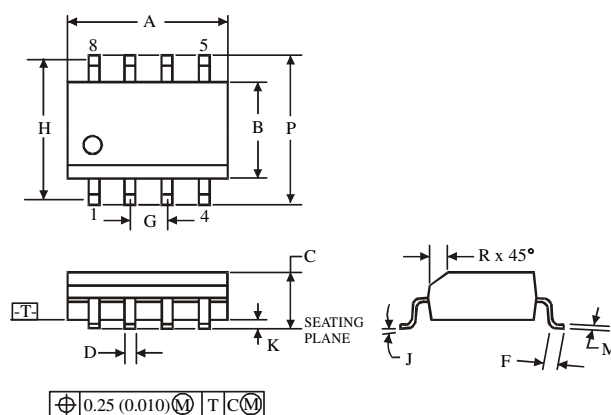
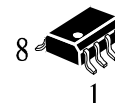

Symbol	Dimension, mm	
	MIN	MAX
A	4.8	5
B	3.8	4
C	1.35	1.75
D	0.33	0.51
F	0.4	1.27
G	1.27	
H	5.72	
J	0°	8°
K	0.1	0.25
M	0.19	0.25
P	5.8	6.2
R	0.25	0.5

NOTES:

- Dimensions A and B do not include mold flash or protrusion.
- Maximum mold flash or protrusion 0.15 mm (0.006) per side  
for A; for B - 0.25 mm (0.010) per side.

SIP-9

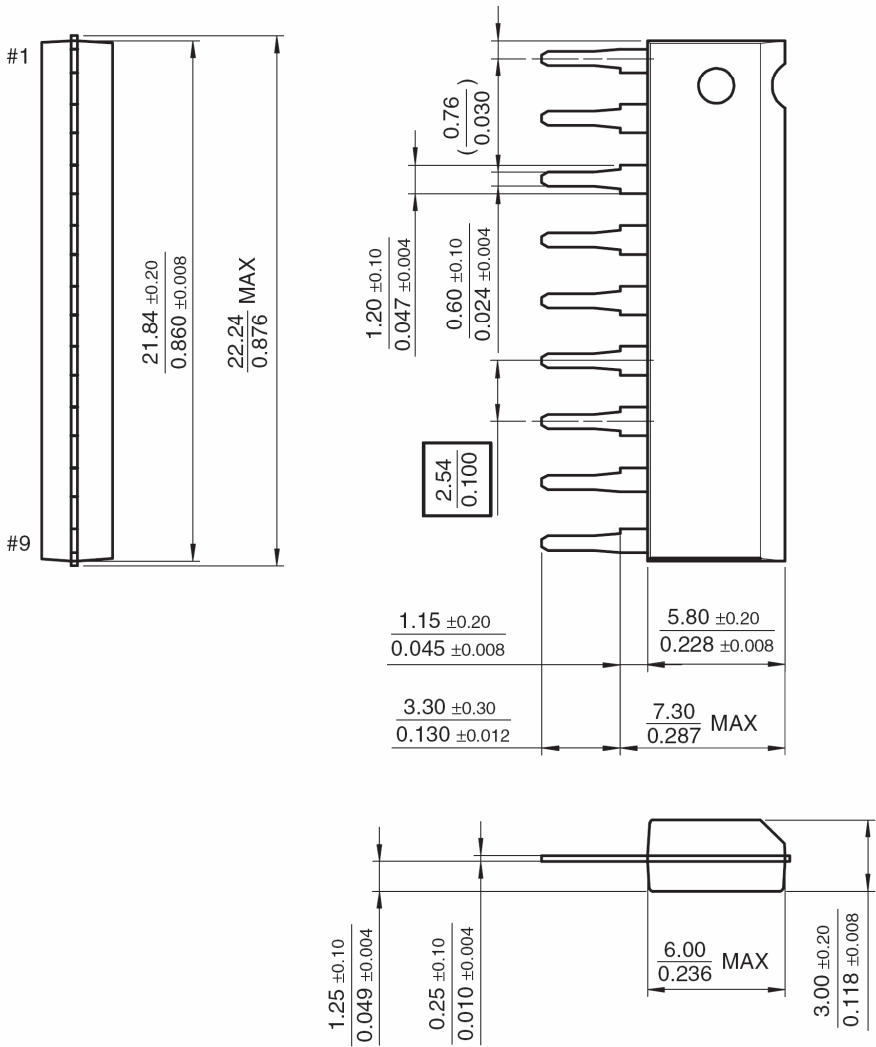
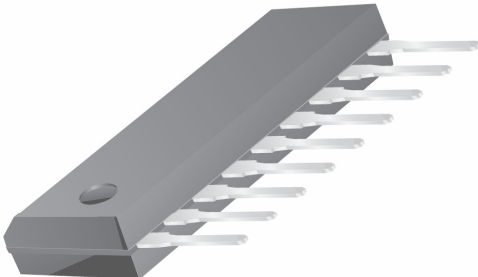

SIP-8

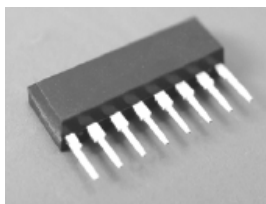

Lead Pitch	2.54mm(100mil)
Pad Size	102mil×102mil
Unit	mm(inch)

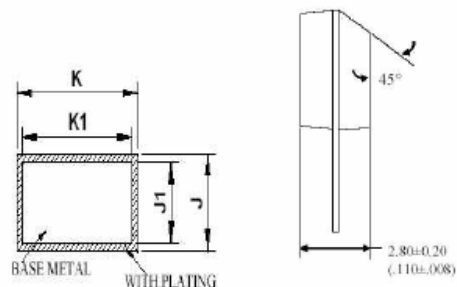
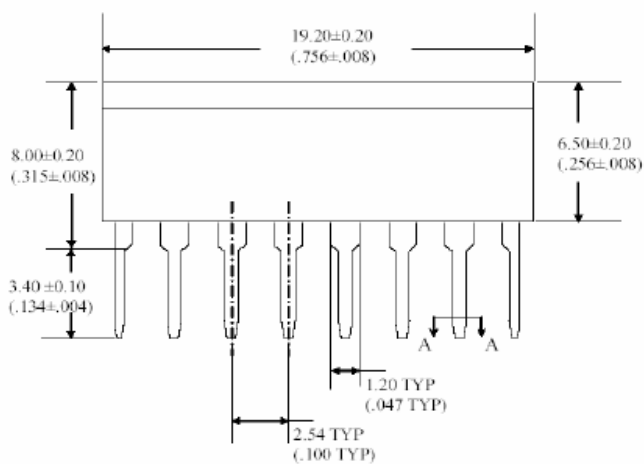

SECTION A-A

DIM	MILLIMETERS		INCHES	
	MIN	MAX	MIN	MAX
J	0.219	0.339	.0086	.0133
J1	0.219	0.289	.0086	.0114
K	0.500	0.650	.0197	.0256
K1	0.500	0.550	.0197	.0217