

T-1^{3/4} (5 mm), T-1 (3 mm), High Performance, Tinted, Diffused, AlInGaP, and TS AlGaAs Red LED Lamps

Technical Data

HLMA-DX05 Series
HLMA-KX05 Series
HLMP-D1XX Series
HLMP-J100/J150 Series

Features

- High Light Output Over a Wide Range of Currents
- Popular T-1 and T-1^{3/4} Packages
- Choice of Three Colors
 Amber
 Reddish-Orange
 Deep Red
- Wide Viewing Angles
- Long Life: Solid State Technology
- Available on Tape and Reel

Applications

- Outdoor Message Boards
- Automotive Lighting
- Portable Equipment
- Medical Equipment
- Changeable Message Signs

Description

The HLMA-D/KXXX series tinted, diffused, solid state lamps utilize the newly developed aluminum indium gallium phosphide (AlInGaP) LED technology. This technology has a very high luminous efficiency, capable of producing high light output over a wide range of drive currents. These LED lamps are available with a choice of two colors, 592

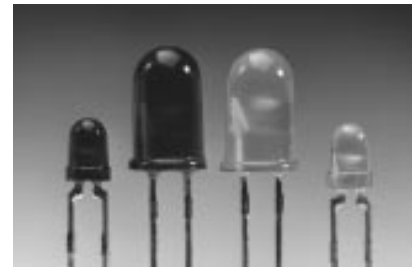

nm amber and 615 nm reddish-orange, and with two viewing angles, 65° and 60°.

The HLMP-D/JXXX series tinted, diffused solid state lamps utilize the highly optimized transparent substrate aluminum gallium arsenide (TS AlGaAs) LED technology. This technology has a very high luminous efficiency,

Device Selection Guide

Package Description	Viewing Angle 2θ ^{1/2}	Amber λ _d = 592 nm	Reddish-Orange λ _d = 615 nm	Deep Red λ _d = 644 nm	Package Outline
T-1 ^{3/4} (5 mm), Tinted, Diffused, Standard Current	65°	HLMA-DL05	HLMA-DH05		A
T-1 (3 mm), Tinted, Diffused, Standard Current	60°	HLMA-KL05	HLMA-KH05		B
T-1 ^{3/4} (5 mm), Tinted, Diffused, Standard Current	40°			HLMP-D115	A
T-1 ^{3/4} (5 mm), Tinted, Diffused, Standard Current	25°			HLMP-D120	A
T-1 (3 mm), Tinted, Diffused, Standard Current	55°			HLMP-J100	C
T-1 (3 mm), Tinted, Diffused, Diffused, Low Current	55°			HLMP-J150	C

capable of producing high light output over the wide range of drive currents from 500 μ A to 50 mA. The color is deep red at a

dominant wavelength of 644 nm. TS AlGaAs is a flip-chip LED technology, die attached to the anode lead and wire bonded to

the cathode lead. Available viewing angles are 25°, 40°, and 55°.

Package Dimensions

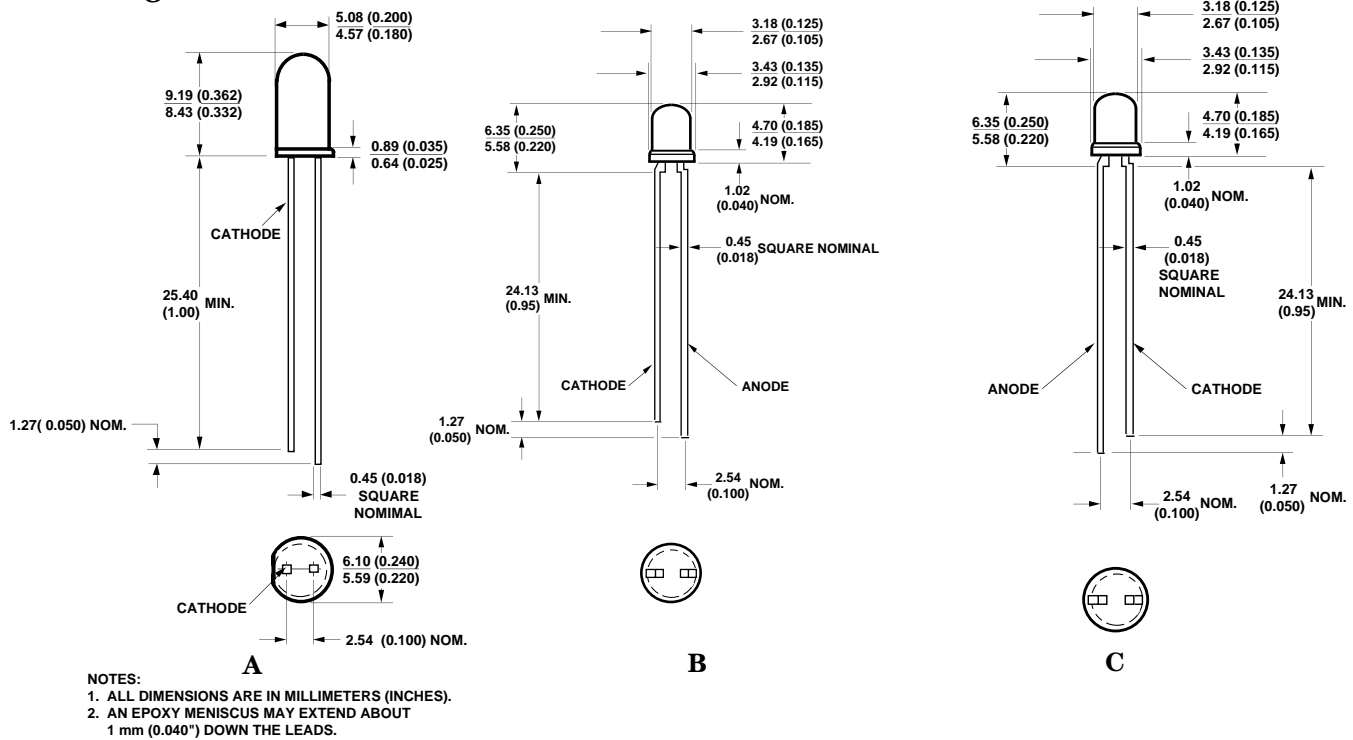

HLMA-DL05/DH05/KL05/KH05 AlInGaP Lamps Absolute Maximum Ratings at $T_A = 25^\circ\text{C}$

Parameter	HLMA-DL05	HLMA-DH05	HLMA-KL05	HLMA-KH05	Units
DC Forward Current ^[1,3,4]	50	50	50	50	mA
Peak Forward Current ^[2]	200	200	200	200	mA
Average Input Power ^[2]	103	103	103	103	mW
Reverse Voltage ($I_R = 100 \mu\text{A}$)	5	5	5	5	V
Operating Temperature Range	-40 to +100	-40 to +100	-40 to +100	-40 to +100	$^\circ\text{C}$
Storage Temperature Range	-55 to +100	-55 to +100	-55 to +100	-55 to +100	$^\circ\text{C}$
Junction Temperature	110				$^\circ\text{C}$
Soldering Temperature [1.59 mm (0.06 in.) below seating plane]	260 $^\circ\text{C}$ for 5 second				

Notes:

- Derate linearly as shown in Figure 4.
- Any pulsed operation cannot exceed the Absolute Max Peak Forward current as specified in Figure 5.
- Drive currents between 10 mA and 30 mA are recommended for best long term performance.
- Operation at currents below 10 mA is not recommended, please contact your Hewlett-Packard sales representative.

Optical Characteristics at $T_A = 25^\circ\text{C}$

Part Number HLMA-	Luminous Intensity I_V (mcd) @ 20 mA ^[1]		Peak Wavelength λ_{peak} (nm) Typ.	Color, Dominant Wavelength λ_d ^[2] (nm) Typ.	Viewing Angle $2\theta^{1/2}$ Degrees ^[3] Typ.	Luminous Efficacy η_V (lm/w)
	Min.	Typ.				
DL05	35	100	594	592	65	480
DH05	35	100	621	615	65	263
KL05	35	100	594	592	60	480
KH05	35	100	621	615	60	263

Notes:

- ϕ_V is the total luminous flux output as measured with an integrating sphere.
- The dominant wavelength, λ_d , is derived from the CIE Chromaticity Diagram and represents the color of the device.
- $\theta^{1/2}$ is the off-axis angle where the luminous intensity is 1/2 the peak intensity.

Electrical Characteristics at $T_A = 25^\circ\text{C}$

Part Number HLMA-	Forward Voltage V_F (Volts) @ $I_F = 20$ mA		Reverse Breakdown V_R (Volts) @ $I_R = 100$ μA		Capacitance C (pF) $V_F = 0$, $f = 1$ mHz Typ.	Thermal Resistance $R_{\theta_{J-PIN}}$ ($^\circ\text{C}/\text{W}$)	Speed of Response τ_s (ns) Time Constant e^{-t/τ_s} Typ.
	Typ.	Max.	Min.	Typ.			
DL05	1.9	2.4	5	25	60	260	13
DH05	1.9	2.4	5	25	60	260	13
KL05	1.9	2.4	5	25	60	290	13
KH05	1.9	2.4	5	25	60	290	13

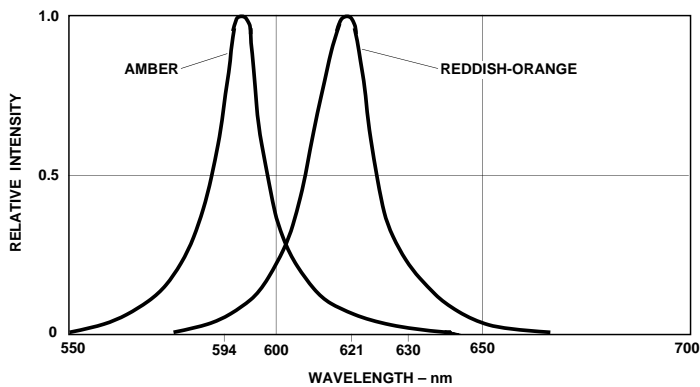

Figure 1. Relative Intensity vs. Wavelength.

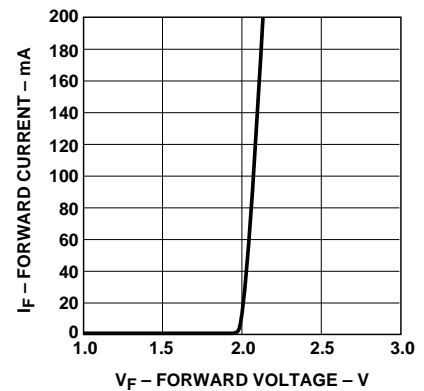

Figure 2. Forward Current vs. Forward Voltage.

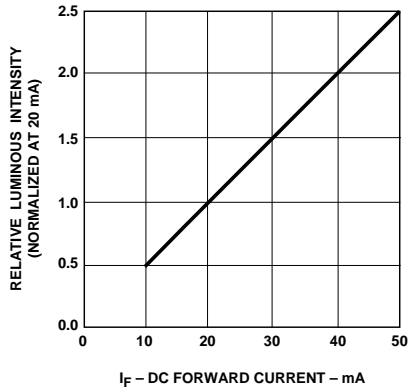

Figure 3. Relative Luminous Intensity vs. Forward Current.

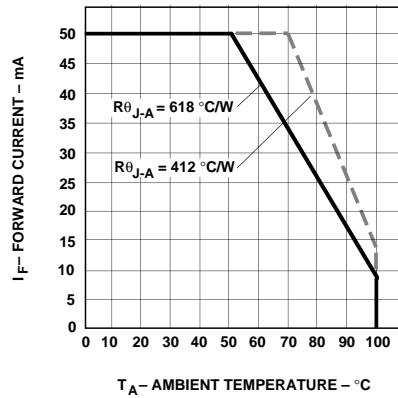

Figure 4. Maximum Forward Current vs. Ambient Temperature. Derating Based on T_j Max = 110°C.

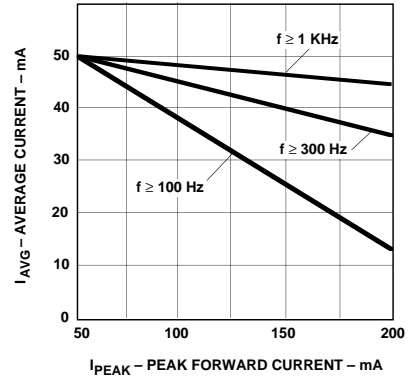

Figure 5. Maximum Average Current vs. Peak Forward Current.

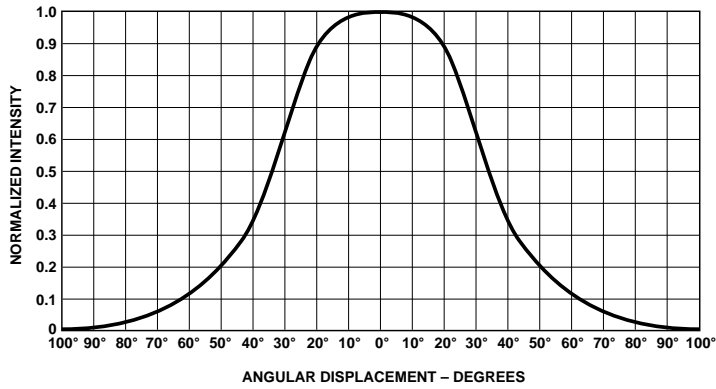

Figure 6. Spatial Radiation Pattern for HLMA-DL05/DH05 65° Lamps.

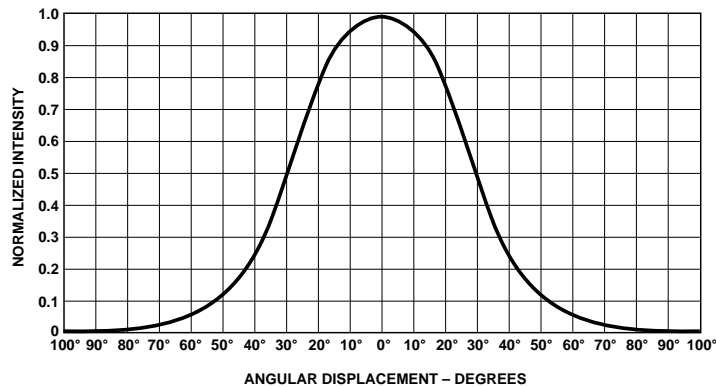

Figure 7. Spatial Radiation Pattern for HLMA-KL05/KH05 60° Lamps.

HLMP-D115/D120/J100/J150 TS AlGaAs Red Lamps

Absolute Maximum Ratings at $T_A = 25^\circ\text{C}$

Parameter	HLMP-D115	HLMP-D120	HLMP-J100	HLMP-J150	Units
DC Forward Current ^[1]	50	50	50	50	mA
Peak Forward Current ^[2]	300	300	300	300	mA
Average Input Power ^[2]	100	100	100	100	mW
Reverse Voltage ($I_R = 100 \mu\text{A}$)	5	5	5	5	V
Operating Temperature Range	-55 to +100	-55 to +100	-55 to +100	-55 to +100	$^\circ\text{C}$
Storage Temperature Range	-55 to +100	-55 to +100	-55 to +100	-55 to +100	$^\circ\text{C}$
Junction Temperature	110				$^\circ\text{C}$
Soldering Temperature [1.59 mm (0.06 in.) below seating plane]	260 $^\circ\text{C}$ for 5 second				

Notes:

- Derate linearly as shown in Figure 12.
- Any pulsed operation cannot exceed the Absolute Max Peak Forward current as specified in Figure 13.

Optical Characteristics at $T_A = 25^\circ\text{C}$

Part Number HLMP-	Luminous Intensity I_V (mcd) @ 20 mA ^[1]		Peak Wavelength λ_{peak} (nm) Typ.	Color, Dominant Wavelength λ_d ^[2] (nm) Typ.	Viewing Angle 2 $\theta_{1/2}$ Degrees ^[3] Typ.	Luminous Efficacy η_V (lm/w)
	Min.	Typ.				
D115	138	250	654	644	40	85
D120	138	350	654	644	25	85
J100	39	175	654	644	55	85
J150	1.3	3.0	654	644	55	85

Notes:

- ϕ_V is the total luminous flux output as measured with an integrating sphere.
- The dominant wavelength, λ_d , is derived from the CIE Chromaticity Diagram and represents the color of the device.
- $\theta_{1/2}$ is the off-axis angle where the luminous intensity is 1/2 the peak intensity.

Electrical Characteristics at $T_A = 25^\circ\text{C}$

Part Number HLMP-	Forward Voltage V_F (Volts) @ $I_F = 20 \text{ mA}$		Reverse Breakdown V_R (Volts) @ $I_R = 100 \mu\text{A}$		Capacitance C (pF) $V_F = 0$ $f = 1 \text{ MHz}$ Typ.	Thermal Resistance $R_{\theta_{J-PIN}}$ ($^\circ\text{C}/\text{W}$)	Speed of Response τ_s (ns) Time Constant e^{-t/τ_s} Typ.
	Min.	Typ.	Min.	Typ.			
D115	1.85	2.4	5	20	20	260	45
D120	1.85	2.4	5	20	20	260	45
J100	1.85	2.4	5	20	20	290	45
J150	1.6	1.9	5	20	20	290	45

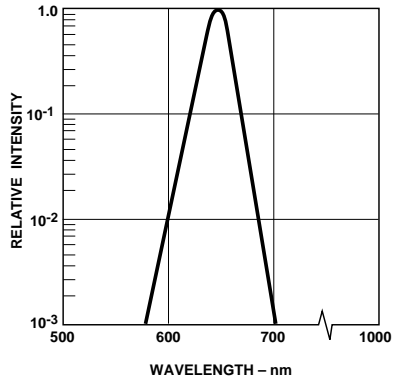

Figure 8. Relative Intensity vs. Wavelength.

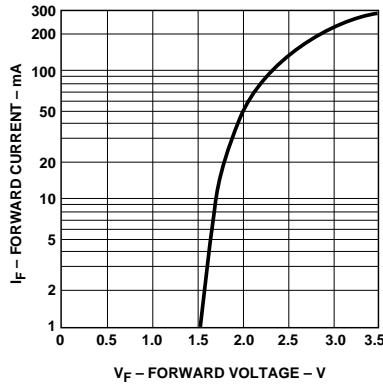

Figure 9. Forward Current vs. Forward Voltage.

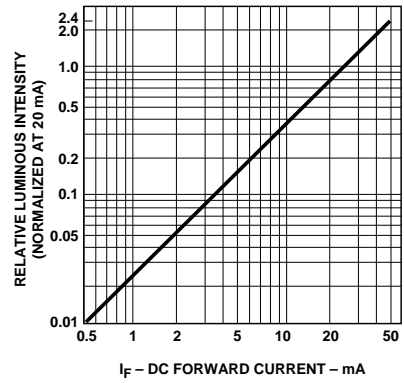

Figure 10. Relative Luminous Intensity vs. DC Forward Current.

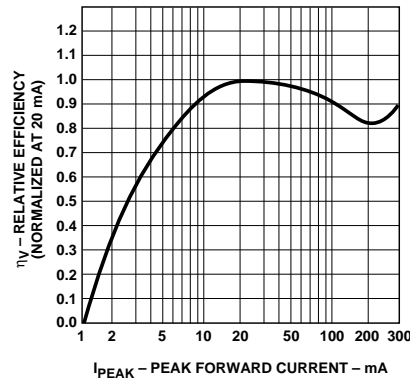

Figure 11. Relative Efficiency vs. Peak Forward Current.

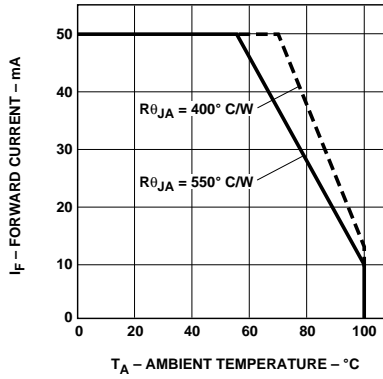

Figure 12. Maximum Forward Current vs. Ambient Temperature. Derating Based on T_J Max = 110°C.

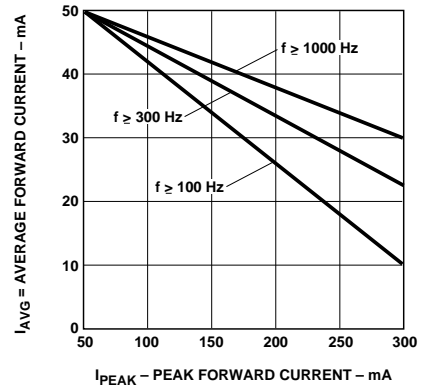

Figure 13. Maximum Average Current vs. Peak Forward Current.

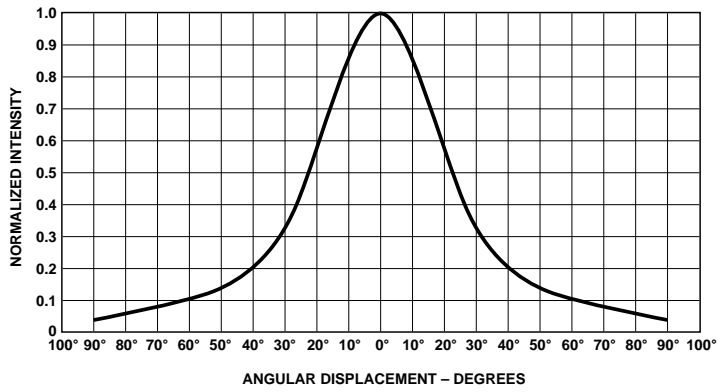

Figure 14. Spatial Radiation Pattern for 40° HLMP-D115 Lamp.

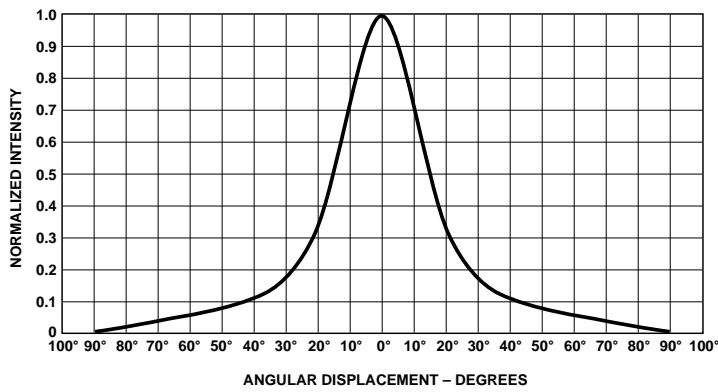

Figure 15. Spatial Radiation Pattern for 25° HLMP-D120 Lamp.

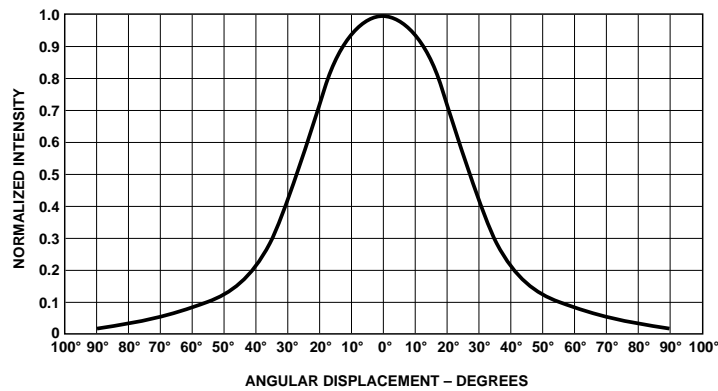

Figure 16. Spatial Radiation Pattern for 55° HLMP-J100-J150 Lamps.