

Descriptions

The S1117 series of positive adjustable and fixed regulators are designed to provide 1A with high efficiency. All internal circuitry is designed to operate down to 1.3V input to output differential. On-chip trimming adjusts reference voltage to 2%.

Features

- Adjustable or fixed output
- Output current of 1A
- Low dropout, 1.3V maximum at 1A output current
- Thermal shutdown protection

Ordering Information

Type NO.	Marking	Package Code
S1117AD/S1117xxD	S1117□□D/ S1117□□□D	D-PAK
□□: Voltage Code (Aj : 1.25V, 15:1.5V,:18: 1.8V, 25:2.5V, 33:3.3V, 50:5.0V) □□□: Voltage Code (285:2.85V)		

Outline Dimensions (Unit : mm)

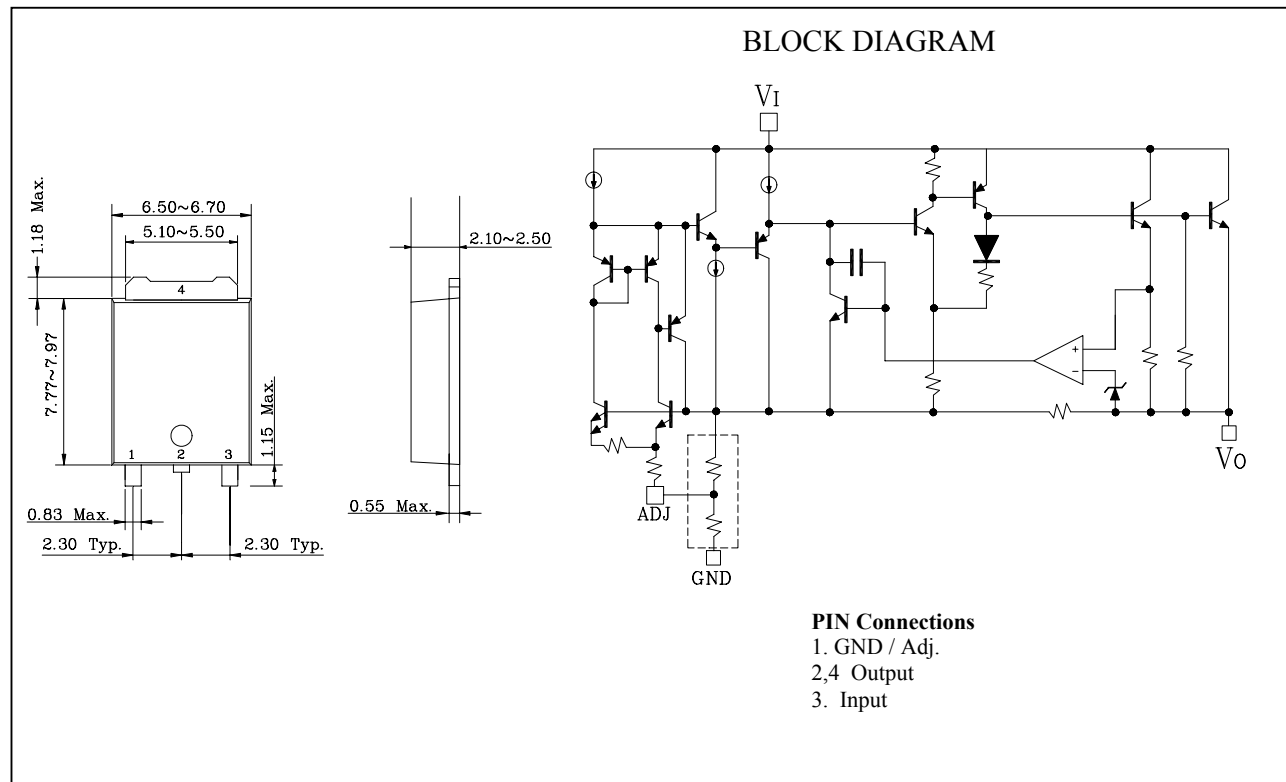

Absolute Maximum Ratings

[Ta=25°C]

Characteristic	Symbol	Rating	Unit
Input voltage	V_I	16	V
Power Dissipation	P_{D1} (Note1)	4.5	W
	P_{D2} (Note2)	1.5	
Junction Temperature	T_J	150	°C
Operating temperature range	T_{opr}	0 ~ +125	°C
Storage temperature range	T_{stg}	-55 ~ +150	°C

Note 1 : Mounted on a glass epoxy circuit board of 50.8 × 50.8mm. (at 1oz copper area)

Note 2 : No Heat sink

Recommended operating conditions

Characteristic	Symbol	Min.	Max.	Unit
Input voltage	V_I	$V_O+1.5V$	V_O+7V	V
Output current	I_O	1	1000	mA

Device Selection Guide

Device	Output Voltage
S1117AD	Adjustable
S1117-15D	1.50V
S1117-18D	1.80V
S1117-25D	2.50V
S1117-285D	2.85V
S1117-33D	3.30V
S1117-50D	5.00V

Note 3 : Other fixed versions are available $V_O=1.5V \sim 5V$

Electrical Characteristics

(Electrical Characteristics at $0^{\circ}\text{C} \leq T_a \leq 125^{\circ}\text{C}$ and $V_I = (V_O + 1.5\text{V})$, $I_O = 10\text{mA}$, $C_O = 10\mu\text{F}$, unless otherwise specified.)

Characteristic	Symbol	Device	Test Condition	Min	Typ	Max	Unit	
Output voltage	V_O	S1117A		*	1.23	1.28	V	
			$V_I = (V_O + 1.5\text{V})$ to 7V $I_O = 0$ to 1000mA		1.20	1.30		
		S1117-15		*	1.47	1.53		
			$V_I = (V_O + 1.5\text{V})$ to 7V $I_O = 0$ to 1000mA		1.44	1.56		
		S1117-18		*	1.76	1.84		
			$V_I = (V_O + 1.5\text{V})$ to 7V $I_O = 0$ to 1000mA		1.73	1.87		
		S1117-25		*	2.45	2.55		
			$V_I = (V_O + 1.5\text{V})$ to 7V $I_O = 0$ to 1000mA		2.40	2.60		
		S1117-285		*	2.79	2.91		
			$V_I = (V_O + 1.5\text{V})$ to 7V $I_O = 0$ to 1000mA		2.74	2.96		
S1117-33		*	3.23	3.37				
	$V_I = (V_O + 1.5\text{V})$ to 7V $I_O = 0$ to 1000mA		3.17	3.43				
S1117-50		*	4.90	5.10				
	$V_I = (V_O + 1.5\text{V})$ to 7V $I_O = 0$ to 1000mA		4.80	5.20				
Line regulation (Note4)	$ \Delta V_{O(\Delta V_I)} $	All	$1.5\text{V} \leq V_I - V_O \leq 7\text{V}$ $I_O = 10\text{mA}$	*	-	5	10	mV
Load regulation (Note4)	$ \Delta V_{O(\Delta I_L)} $	All	$1.5\text{V} \leq V_I - V_O \leq 7\text{V}$ $I_O = 10\text{mA} \sim 1000\text{mA}$	*	-	10	30	mV
Quiescent current	I_{QC}	All	$I_O = 0$		-	7	13	mA
Minimum load current	$I_{L(\text{MIN})}$	S1117A	$V_{\text{Adj}} = 0\text{V}$			3	7	mA
Adjust pin current	I_{ADJ}	S1117A	$V_I = (V_O + 1.5\text{V})$ to 7V $I_O = 100\text{mA}$			55	90	μA
Adjust pin current change	$ \Delta I_{\text{ADJ}} $	S1117A	$1.5\text{V} \leq V_I - V_O \leq 7\text{V}$ $I_O = 10\text{mA} \sim 1000\text{mA}$			1	5	μA
Dropout voltage	V_{DROP}	All	$I_O = 1000\text{mA}$	*	-	1.2	1.3	V
Ripple rejection ratio	RR	All	$I_O = 1000\text{mA}$ $V_{\text{Ripple}} = 1\text{V}_{\text{P-P}}$, $f = 120\text{Hz}$	*	60	72	-	dB
Current limit	I_{LIMIT}	All	$I_O \geq 1000\text{mA}$	*	1.1			A

[*] $T_a = 25^{\circ}\text{C}$

Note 4: Low duty pulse testing with Kelvin connections required.

■ Typical Applications

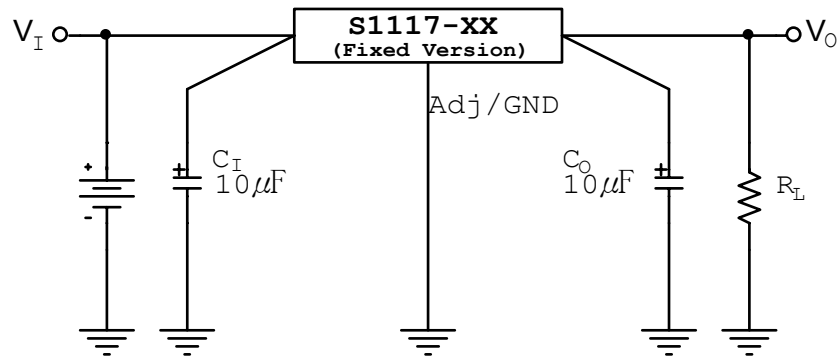
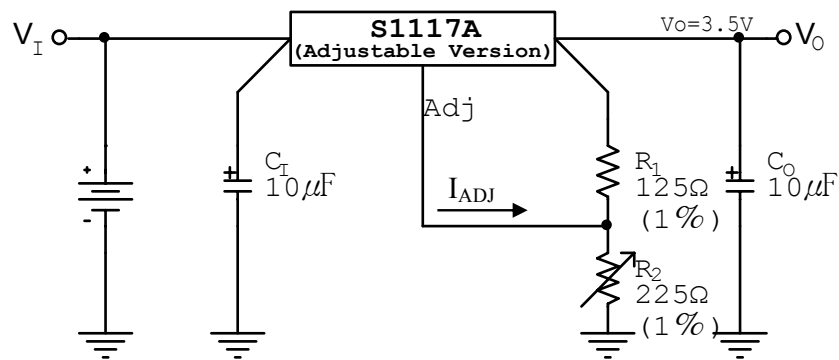

Fig. 1 Fixed Voltage Regulator



$$V_O = V_{ADJ} \times \left(1 + \frac{R_2}{R_1}\right) + I_{ADJ} \times R_2$$

Fig. 2 Adjustable Voltage Regulator

Notes 5:

- 1) C_I needed if device is far from filter capacitors
- 2) C_O minimum value required for stability

Electrical Characteristic Curves

Fig.3 V_{DROP} vs I_O

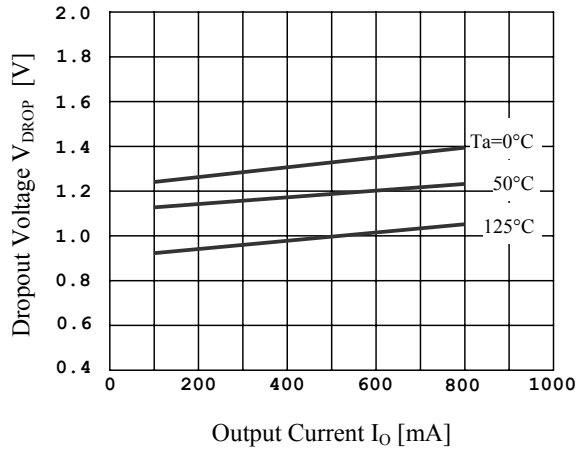

Fig.4 V_O vs T_a

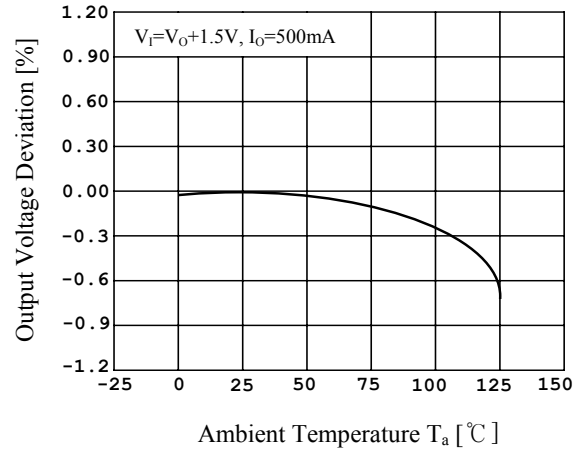

Fig.5 $I_{L(\text{MIN})}$ vs $V_I - V_O$

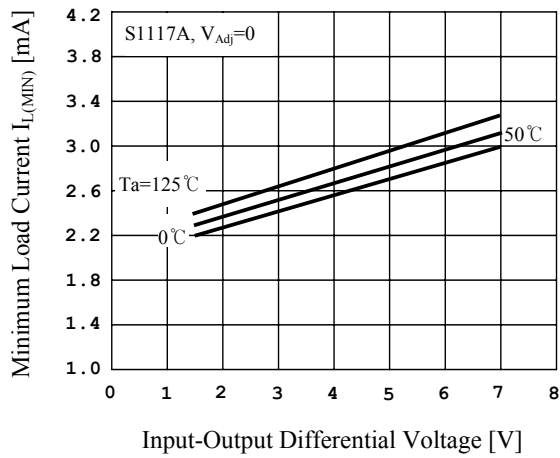

Fig.6 I_{Adj} vs T_a

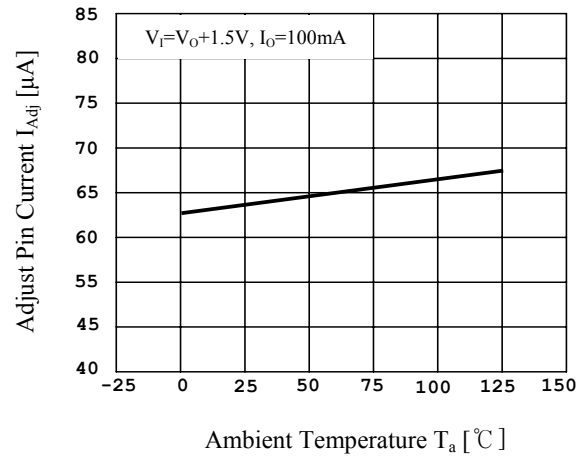
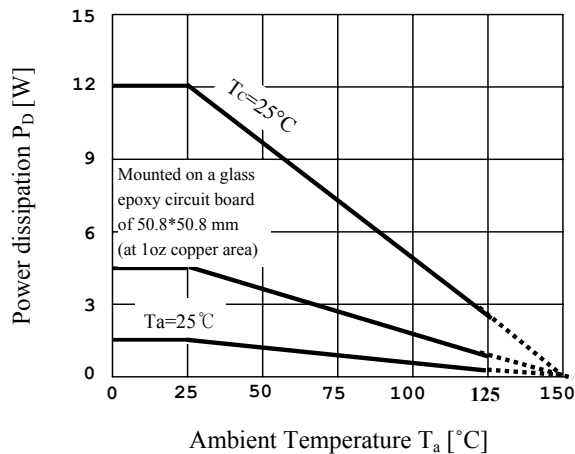

Fig.7 P_D vs T_a



The AUK Corp. products are intended for the use as components in general electronic equipment (Office and communication equipment, measuring equipment, home appliance, etc.).

Please make sure that you consult with us before you use these AUK Corp. products in equipments which require high quality and / or reliability, and in equipments which could have major impact to the welfare of human life(atomic energy control, airplane, spaceship, transportation, combustion control, all types of safety device, etc.). AUK Corp. cannot accept liability to any damage which may occur in case these AUK Corp. products were used in the mentioned equipments without prior consultation with AUK Corp..

Specifications mentioned in this publication are subject to change without notice.