

FEATURES

- RF Power Amplifier Control in ThinSOT™ Package
- Internal Schottky Diode Detector with >45dB Range
- Wide Input Frequency Range:
 300MHz to 2.7GHz (LTC4400-1)
 300MHz to 2GHz (LTC4400-2)
- Autozero Loop Cancels Offset Errors and Temperature Dependent Offsets
- Wide V_{CC} Range: 2.7V to 6V
- Automatic Bandwidth Control Improves Low Power Ramp Response
- Allows Direct Connection to Battery
- RF Output Power Set by External DAC
- Internal Frequency Compensation
- Rail-to-Rail Power Control Output
- Power Control Signal Overvoltage Protection
- Low Operating Current: 1mA
- Low Shutdown Current: 10µA
- Two Pole PCTL Input Filtering
- Low Profile (1mm) ThinSOT (LTC4400-1) and 8-Pin MSOP (LTC4400-2) Packages

APPLICATIONS

- GSM/GPRS Cellular Telephones
- PCS Devices
- Wireless Data Modems
- U.S. TDMA Cellular Phones

DESCRIPTION

The LTC® 4400-1 is a SOT-23 RF power controller for fast turn-on RF power amplifiers operating in the 300MHz to 2.7GHz range. Examples include the Hitachi PF08109B, PF08122B, PF08123B, PF08107B and RF Micro Devices RF3108. For slow turn-on RF power amplifiers refer to the LTC4401-1/LTC4401-2.

RF power is controlled by driving the RF amplifier power control pin and sensing the resultant RF output power via a directional coupler or capacitive tap. The RF input voltage is peak detected using an on-chip Schottky diode. This detected voltage is compared to the DAC voltage at the PCTL pin to control the output power. The RF power amplifier is protected against high power control pin voltages.

Internal and external offsets are cancelled over temperature by an autozero control loop, allowing accurate low power programming. The shutdown feature disables the part and reduces the supply current to <10µA.

A dual control channel version (LTC4400-2) is also available in an 8-pin MSOP package.

LT, LTC and LT are registered trademarks of Linear Technology Corporation. ThinSOT is a trademark of Linear Technology Corporation.

TYPICAL APPLICATION

LTC4400-1 Dual Band Cellular Telephone Transmitter

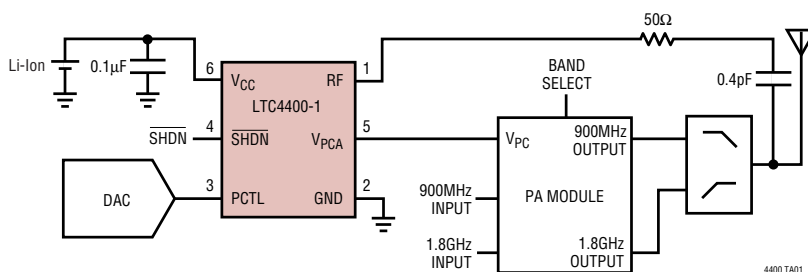

LTC4400-1 Detector Characteristics at 900MHz and 1800MHz

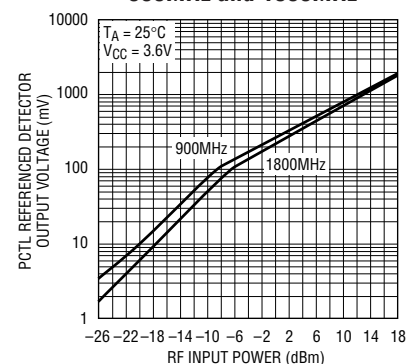

4400 TA04

sn4400 4400fas

LTC4400-1/LTC4400-2

ABSOLUTE MAXIMUM RATINGS (Note 1)

V_{CC} to GND	-0.3V to 6.5V	$I_{V_{PCA/B}}$	10mA
$V_{PCA/B}$ Voltage to GND	-0.3V to 3.2V	Operating Temperature Range (Note 2) ..	-40°C to 85°C
PCTL Voltage to GND	-0.3V to ($V_{CC} + 0.3V$)	Storage Temperature Range	-65°C to 150°C
RF Voltage to GND	($V_{CC} - 2.6V$) to 7V	Maximum Junction Temperature	125°C
BSEL, SHDN Voltage to GND	-0.3V to ($V_{CC} + 0.3V$)	Lead Temperature (Soldering, 10 sec).....	300°C

PACKAGE/ORDER INFORMATION

	ORDER PART NUMBER		ORDER PART NUMBER
	LTC4400-1ES6		LTC4400-2EMS8
	S6 PART MARKING		MS8 PART MARKING
	LTWZ		LTXB

Consult LTC Marketing for parts specified with wider operating temperature ranges.

ELECTRICAL CHARACTERISTICS

The ● denotes specifications which apply over the full operating temperature range, otherwise specifications are at $T_A = 25^\circ\text{C}$, $V_{CC} = 3.6\text{V}$, $\text{SHDN} = \text{HI}$, unless otherwise noted.

PARAMETER	CONDITIONS	MIN	TYP	MAX	UNITS	
V_{CC} Operating Voltage		● 2.7		6	V	
$I_{V_{CC}}$ Shutdown Current	$\overline{\text{SHDN}} = 0\text{V}$	●	10	20	μA	
$I_{V_{CC}}$ Operating Current	$\overline{\text{SHDN}} = \text{HI}$, $I_{V_{PCA/B}} = 0\text{mA}$	●	1.2	1.9	mA	
$V_{PCA/B} V_{OL}$	$R_{LOAD} = 400\Omega$, Enabled	● 0		0.05	V	
$V_{PCA/B}$ Dropout Voltage	$I_{LOAD} = 6\text{mA}$, $V_{CC} = 2.7\text{V}$	●		$V_{CC} - 0.25$	V	
$V_{PCA/B}$ Voltage Clamp	PCTL = 1V	● 2.7	2.9	3.1	V	
$V_{PCA/B}$ Output Current	$V_{PCA/B} = 2.4\text{V}$, $V_{CC} = 3\text{V}$	● 7	10		mA	
$V_{PCA/B}$ Enable Time	$\overline{\text{SHDN}} = V_{CC}$ (Note 5)	●	9	10.2	μs	
$V_{PCA/B}$ Bandwidth	$C_{LOAD} = 100\text{pF}$, $R_{LOAD} = 400\Omega$ (Note 8)	●	350	450 230	kHz kHz	
$V_{PCA/B}$ Load Capacitance		●		100	pF	
$V_{PCA/B}$ Slew Rate	$V_{PCTL} = 2\text{V Step}$, $C_{LOAD} = 100\text{pF}$, $R_{LOAD} = 400\Omega$ (Note 3)	●	1.8	2.5	3	V/ μs
$V_{PCA/B}$ Droop			1		$\mu\text{V/ms}$	
$V_{PCA/B}$ Start Voltage	Open Loop (Note 9)	● 270	450	550	mV	
BSEL, SHDN Input Threshold	$V_{CC} = 2.7\text{V to } 6\text{V}$	● 0.35		1.4	V	
BSEL, SHDN Input Current	$\overline{\text{BSEL}} = \overline{\text{SHDN}} = 3.6\text{V}$	● 16	24	36	μA	
PCTL Input Voltage Range	(Note 7)	● 0		2.4	V	
PCTL Input Resistance		● 60	90	120	k Ω	
PCTL Input Filter			270		kHz	
Autozero Range	(Note 4)	●		400	mV	

sn4400 4400fas

ELECTRICAL CHARACTERISTICS The ● denotes specifications which apply over the full operating temperature range, otherwise specifications are at $T_A = 25^\circ\text{C}$. $V_{CC} = 3.6\text{V}$, $\overline{\text{SHDN}} = \text{HI}$, unless otherwise noted.

PARAMETER	CONDITIONS	MIN	TYP	MAX	UNITS
RF Input Frequency Range	LTC4400-1 (Note 6) LTC4400-2 (Note 6)	300 300		2700 2000	MHz MHz
RF Input Power Range (LTC4400-1)	RF Frequency = 900MHz (Note 6) RF Frequency = 1800MHz (Note 6) RF Frequency = 2400MHz (Note 6) RF Frequency = 2700MHz (Note 6)	-28 -26 -24 -22		18 18 16 16	dBm dBm dBm dBm
RF Input Power Range (LTC4400-2)	RF Frequency = 900MHz (Note 6) RF Frequency = 2000MHz (Note 6)	-28 -26		18 18	dBm dBm
RF Input Resistance	Referenced to V_{CC}	● 150	250	350	Ω

Note 1: Absolute Maximum Ratings are those values beyond which the life of a device may be impaired.

Note 2: Specifications over the -40°C to 85°C operating temperature range are assured by design, characterization and correlation with statistical process controls.

Note 3: Slew rate is measured open loop. The slew time at $V_{P_{CA/B}}$ is measured between 1V and 2V.

Note 4: Maximum DAC zero-scale offset voltage that can be applied to PCTL.

Note 5: This is the time from $\overline{\text{SHDN}}$ rising edge 50% switch point to $V_{P_{CA}} = 0.25\text{V}$.

Note 6: Guaranteed by design. This parameter is not production tested.

Note 7: Includes maximum DAC offset voltage and maximum control voltage.

Note 8: Bandwidth is calculated using the 10% to 90% rise time:

$$BW = 0.35/\text{rise time}$$

Note 9: Measured 12 μs after $\overline{\text{SHDN}} = \text{HI}$.

TYPICAL PERFORMANCE CHARACTERISTICS

LTC4400-1 Detector Characteristics at 900MHz

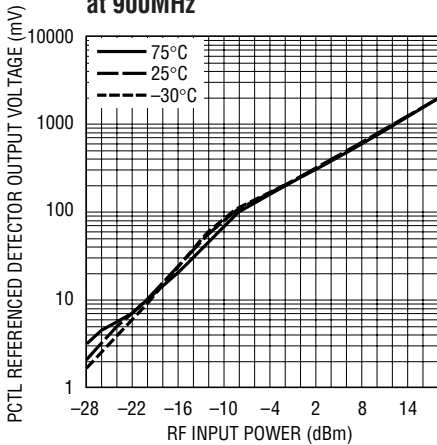

4401 G01

LTC4400-1 Detector Characteristics at 1800MHz

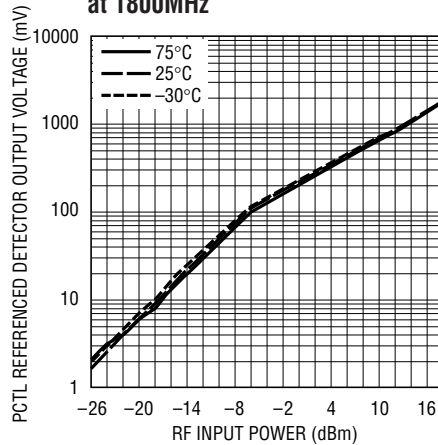

4401 G02

LTC4400-1 Detector Characteristics at 2400MHz

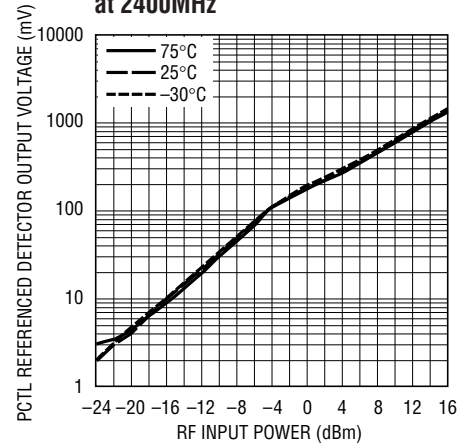

4401 G03

TYPICAL PERFORMANCE CHARACTERISTICS

LTC4400-1 Detector Characteristics at 2700MHz

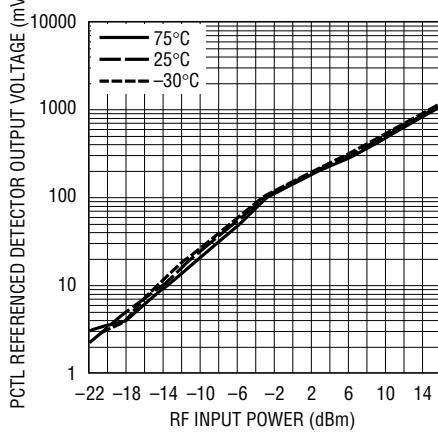

4401 G04

LTC4400-2 Detector Characteristics at 900MHz

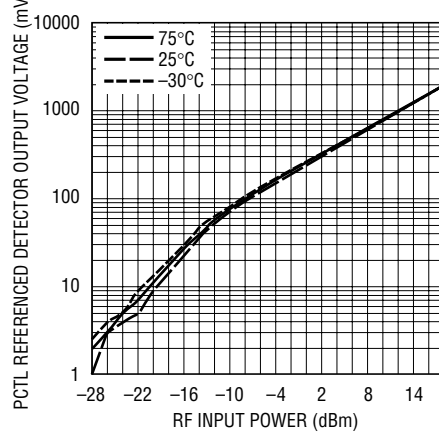

4400 G05

LTC4400-2 Detector Characteristics at 1800MHz

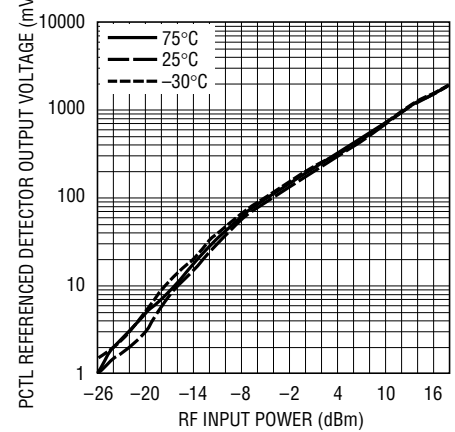

4400 G06

PIN FUNCTIONS (LTC4400-1/LTC4400-2)

RF (Pins 1/8): RF Feedback Voltage. This input is referenced to V_{CC} . The frequency range is 300MHz to 2700MHz for the LTC4400-1 and 300MHz to 2000MHz for the LTC4400-2. This pin has an internal 250Ω termination, an internal Schottky diode detector and peak detector capacitor.

GND (Pins 2/4): System Ground.

PCTL (Pins 3/5): Analog Input. The external power control DAC drives this input. The amplifier servos the RF power until the RF detected signal equals the DAC signal. The input impedance is typically $90k\Omega$.

V_{PCB} (Pin 3): (LTC4400-2 Only) Power Control Voltage Output. This pin drives an external RF power amplifier power control pin. The maximum load capacitance is $100pF$.

\overline{SHDN} (Pins 4/6): Shutdown Input. A logic low on the \overline{SHDN} pin places the part in shutdown mode. A logic high places the part in enable mode. \overline{SHDN} has an internal $150k$ pull-down resistor to ensure that the part is in shutdown when the drivers are in a three-state condition.

V_{PCA} (Pins 5/2): Power Control Voltage Output. This pin drives an external RF power amplifier power control pin. The maximum load capacitance is $100pF$.

V_{CC} (Pins 6/1): Input Supply Voltage, 2.7V to 6V. V_{CC} should be bypassed with $0.1\mu F$ and $100pF$ ceramic capacitors. Used as return for RF 250Ω termination.

BSEL (Pin 7): (LTC4400-2 Only) Selects V_{PCA} when Low and V_{PCB} when High. This input has an internal $150k$ resistor to ground.

BLOCK DIAGRAM (LTC4400-2)

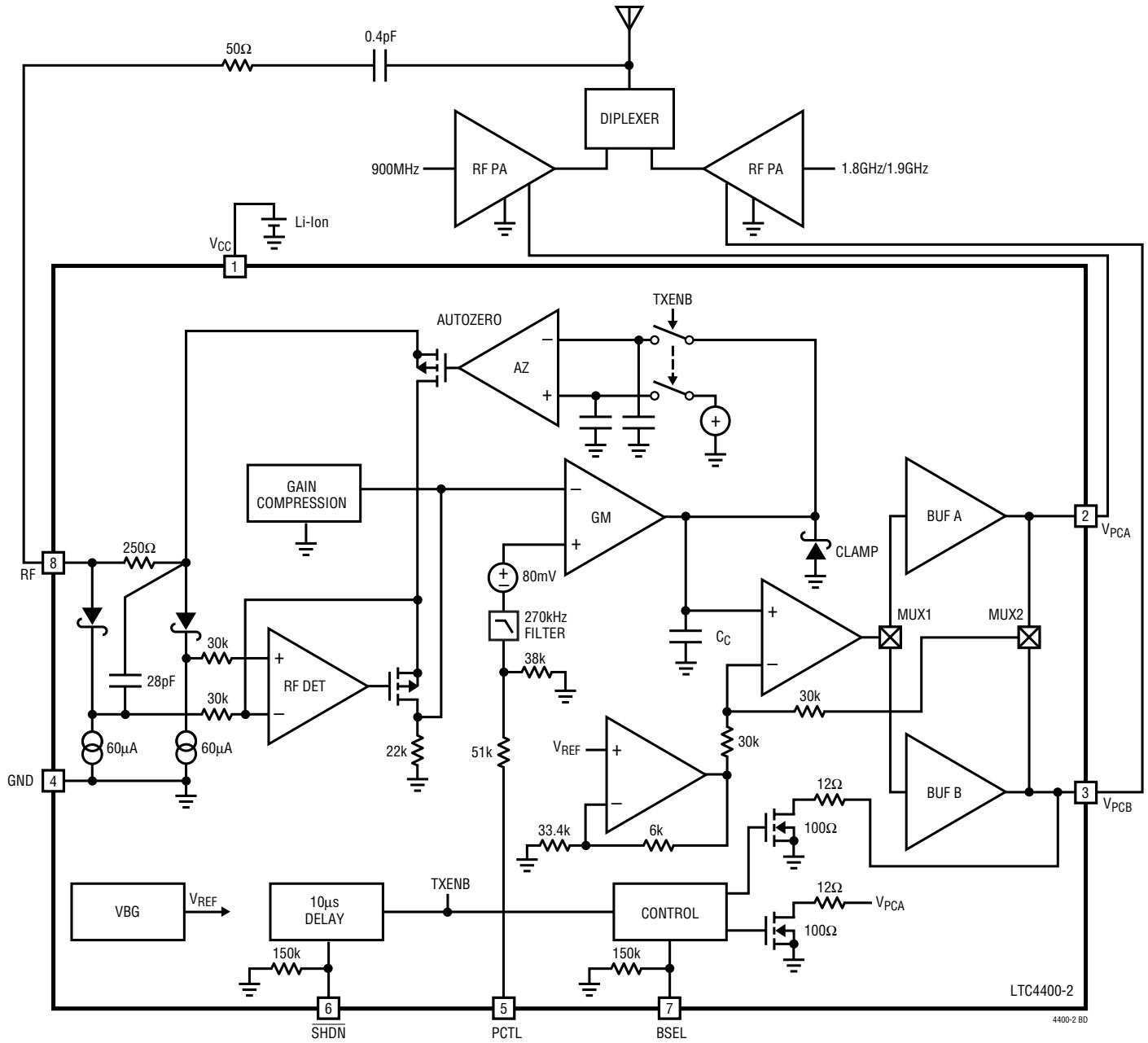

APPLICATIONS INFORMATION

Operation

The LTC4400-X RF power control amplifier integrates several functions to provide RF power control over frequencies ranging from 300MHz to 2.7GHz. This product is well suited to control RF power amplifiers that exhibit fast turn-on times. The device also prevents damage to the RF power amplifier due to overvoltage conditions. These functions include an internally compensated power control amplifier to control the RF output power, an autozero section to cancel internal and external voltage offsets, an RF Schottky diode peak detector and amplifier to convert the RF feedback signal to DC, a $V_{PCA/B}$ overvoltage clamp, compression and a bandgap reference.

Band Selection

The LTC4400-2 is designed to drive two separate power control lines. The BSEL pin will select V_{PCA} when low and V_{PCB} when high. BSEL must be established prior to SHDN being asserted high.

Control Amplifier

The control amplifier supplies the power control voltage to the RF power amplifier. A portion (typically -19dB for low frequencies and -14dB for high frequencies) of the RF output voltage is sampled, via a directional coupler or capacitive tap, to close the gain control loop. When a DAC voltage is applied to PCTL, the amplifier quickly servos $V_{PCA/B}$ positive until the detected feedback voltage applied to the RF pin matches the voltage at PCTL. This feedback loop provides accurate RF power control. $V_{PCA/B}$ is capable of driving a 6mA load current and 100pF load capacitor.

Control Amplifier Compression

The gain compression breakpoints are at PCTL = 80mV and PCTL = 160mV. Above 160mV the gain does not change. The compression changes the feedback attenuation these by reducing the loop gain.

RF Detector

The internal RF Schottky diode peak detector and amplifier converts the RF feedback voltage to a low frequency voltage. This voltage is compared to the DAC voltage at the PCTL pin by the control amplifier to close the RF

power control loop. The RF pin input resistance is typically 250Ω and the frequency range of this pin is 300MHz to 2700MHz for the LTC4400-1 and 300MHz to 2000MHz for the LTC4400-2. The detector demonstrates excellent efficiency over a wide range of input power. The Schottky detector is biased at about $60\mu\text{A}$ and drives an on-chip peak detector capacitor of 28pF.

Autozero

An autozero system is included to improve power programming accuracy over temperature. This section cancels internal offsets associated with the Schottky diode detector and control amplifier. External offsets associated with the DAC driving the PCTL pin are also cancelled. Offset drift due to temperature is cancelled between each burst. The maximum offset voltage allowed at the DAC output is limited to 400mV. Autozeroing is performed during a $10\mu\text{s}$ period after SHDN is asserted high. An internal timer enables the $V_{PCA/B}$ output after $10\mu\text{s}$. The autozero capacitors are held and the $V_{PCA/B}$ pin is connected to the control amplifier output. The hold droop voltage of typically $<1\mu\text{V/ms}$ provides for accurate offset cancellation. The part should be shut down between bursts or after multiple consecutive bursts.

Filter

There is a 270kHz two pole filter included in the PCTL path to remove DAC noise.

Protection Features

The RF power amplifier control voltage pin is overvoltage protected. The $V_{PCA/B}$ overvoltage clamp regulates $V_{PCA/B}$ to 2.9V when the gain and PCTL input combination attempts to exceed this voltage.

Modes of Operation

Shutdown: The part is in shutdown mode when $\overline{\text{SHDN}}$ is low. $V_{PCA/B}$ is held at ground and the power supply current is typically $10\mu\text{A}$.

Enable: When $\overline{\text{SHDN}}$ is asserted high the part will automatically calibrate out all offsets. This takes $<10\mu\text{s}$ and is controlled by an internal delay circuit. After $10\mu\text{s}$ $V_{PCA/B}$ will step up to the starting voltage of 450mV. The user can

APPLICATIONS INFORMATION

then apply the ramp signal. The user should wait $12\mu\text{s}$ after $\overline{\text{SHDN}}$ has been asserted high before applying the ramp. The DAC should be settled $2\mu\text{s}$ after asserting $\overline{\text{SHDN}}$ high.

LTC4400-X Timing Diagram

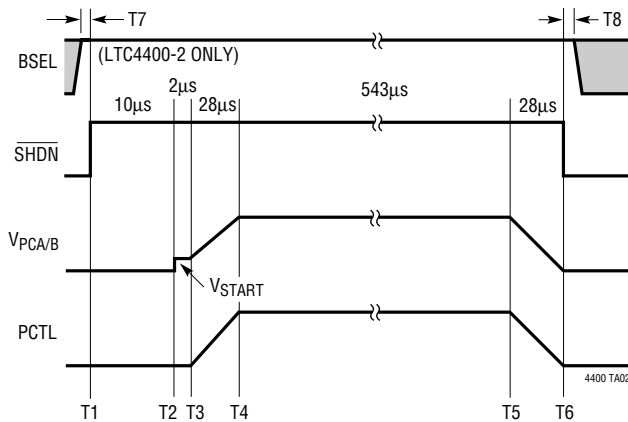

- T1: LTC4400-X COMES OUT OF SHUTDOWN $12\mu\text{s}$ PRIOR TO BURST
 T2: INTERNAL TIMER COMPLETES AUTOZERO CORRECTION, $<10\mu\text{s}$
 T3: BASEBAND CONTROLLER STARTS RF POWER RAMP UP AT $12\mu\text{s}$ AFTER $\overline{\text{SHDN}}$ IS ASSERTED HIGH
 T4: BASEBAND CONTROLLER COMPLETES RAMP UP
 T5: BASEBAND CONTROLLER STARTS RF POWER RAMP DOWN AT END OF BURST
 T6: LTC4400-X RETURNS TO SHUTDOWN MODE BETWEEN BURSTS
 T7: BSEL CHANGE PRIOR TO $\overline{\text{SHDN}}$, 0ns TYPICAL (LTC4400-2 ONLY)
 T8: BSEL CHANGE AFTER TO $\overline{\text{SHDN}}$, 0ns TYPICAL (LTC4400-2 ONLY)

General Layout Considerations

The LTC4400-X should be placed near the coupling components. The feedback signal line to the RF pin should be a 50Ω transmission line with optional termination or a short line.

External Termination

The LTC4400-X has an internal 250Ω termination resistor at the RF pin. If a directional coupler is used, it is recommended that an external 68Ω termination resistor be connected between the RF coupling capacitor (33pF), and ground at the side connected to the directional coupler. Termination components should be placed adjacent to the LTC4400-X. An alternative method couples RF from the power amplifier to the power controller through a $0.4\text{pF} \pm 0.05\text{pF}$ capacitor and 50Ω series resistor, completely eliminating the directional coupler.

Power Ramp Profiles

The external voltage gain associated with the RF channel can vary significantly between RF power amplifier types. The LTC4400-X frequency compensation has been optimized to be stable with several different power amplifiers and manufacturers. This frequency compensation generally defines the loop dynamics that impact the power/time response and possibly (slow loops) the power ramp sidebands. The LTC4400-X operates open loop until an RF voltage appears at the RF pin, at which time the loop closes and the output power follows the DAC profile. The RF power amplifier will require a certain control voltage level (threshold) before an RF output signal is produced. The LTC4400-X $V_{\text{PCA/B}}$ output must quickly rise to this threshold voltage in order to meet the power/time profile. To reduce this time, the LTC4400-X starts at 450mV . However, at very low power levels the PCTL input signal is small, and the $V_{\text{PCA/B}}$ output may take several microseconds to reach the RF power amplifier threshold voltage. To reduce this time, it may be necessary to apply a positive pulse at the start of the ramp to quickly bring the $V_{\text{PCA/B}}$ output to the threshold voltage. This can generally be achieved with DAC programming. The magnitude of the pulse is dependent on the RF amplifier characteristics.

Power ramp sidebands and power/time are also a factor when ramping to zero power. When the power is ramped down the loop will eventually open at power levels below the LTC4400-X detector threshold. The LTC4400-X will then go open loop and the output voltage at $V_{\text{PCA/B}}$ will stop falling. If this voltage is high enough to produce RF output power, the power/time or power ramp sidebands may not meet specification. This problem can be avoided by starting the DAC ramp from 100mV (Figure 1). At the end of the cycle, the DAC can be ramped down to 0mV . This applies a negative signal to the LTC4400-X thereby ensuring that the $V_{\text{PCA/B}}$ output will ramp to 0V . The 100mV ramp step must be applied $<2\mu\text{s}$ after $\overline{\text{SHDN}}$ is asserted high to allow the autozero to cancel the step. Slow DAC rise times will extend this time by the additional RC time constants which may require that the DAC is enabled and settled prior to $\overline{\text{SHDN}}$ asserted high.

APPLICATIONS INFORMATION

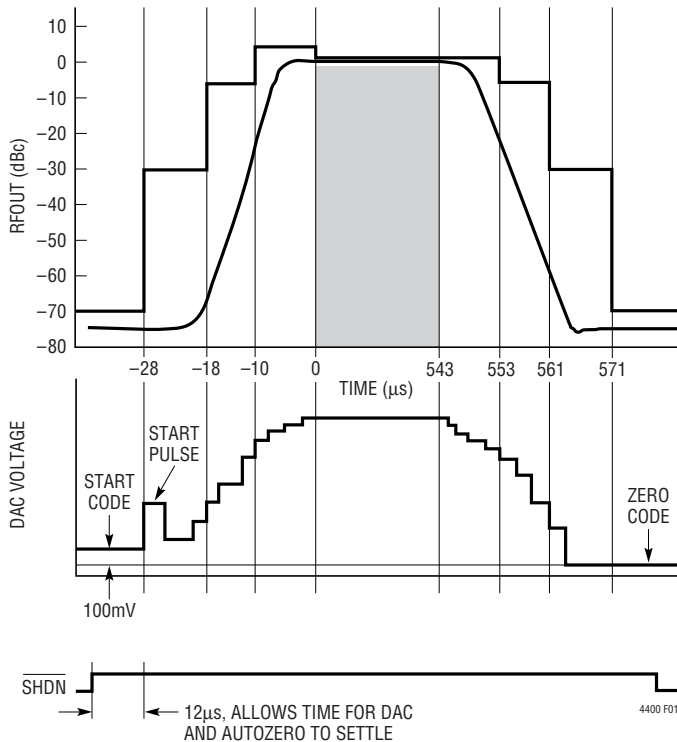

Figure 1. LTC4400-X Ramp Timing

Demo Board

The LTC4400-X demo board is available upon request. The demo board has a 900MHz and an 1800MHz RF channel controlled by the LTC4400-X. Timing signals for $\overline{\text{SHDN}}$ are generated on the board using a 13MHz crystal reference. The PCTL power control pin is driven by a 10-bit DAC and the DAC profile can be loaded via a serial port. The serial port data is stored in a flash memory which is capable of storing eight ramp profiles. The board is supplied preloaded with four GSM power profiles and four DCS power profiles covering the entire power range. External timing signals can be used in place of the internal crystal controlled timing. A variety of RF power amplifiers as well as ramp generation software are available.

LTC4400-X Control Loop Stability

The LTC4400-X provides a stable control loop for several RF power amplifier models from different manufacturers over a wide range of frequencies, output power levels and V_{SWR} conditions. However, there are several factors that can improve or degrade loop frequency stability.

1) The additional voltage gain supplied by the RF power amplifier increases the loop gain raising poles normally below the 0dB axis. The extra voltage gain can vary significantly over input/output power ranges, frequency, power supply, temperature and manufacturer. RF power amplifier gain control transfer functions are often not available and must be generated by the user. Loop oscillations are most likely to occur in the midpower range where the external voltage gain associated with the RF power amplifier typically peaks. It is useful to measure the oscillation or ringing frequency to determine whether it corresponds to the expected loop bandwidth and thus is due to high gain bandwidth.

2) Loop voltage losses supplied by the RF feedback coupler will improve phase margin. The larger the loss, the more stable the loop will become. However, larger losses reduce the RF signal to the LTC4400-X and detector performance may be degraded at low power levels. (See RF Detector Characteristics.)

3) Additional poles within the loop due to filtering or the turn-on response of the RF power amplifier can degrade the phase margin if these pole frequencies are near the effective loop bandwidth frequency. Generally loops using RF power amplifiers with fast turn-on times have more phase margin. Extra filtering below 16MHz should never be placed within the control loop, as this will only degrade phase margin.

4) Control loop instability can also be due to open-loop issues. RF power amplifiers should first be characterized in an open-loop configuration to ensure self oscillation is not present. Self-oscillation is often related to poor power supply decoupling, ground loops, coupling due to poor layout and extreme V_{SWR} conditions. The oscillation frequency is generally in the 100kHz to 10MHz range. Power supply related oscillation suppression requires large value ceramic decoupling capacitors placed close to the RF power amp supply pins. The range of decoupling capacitor values is typically 1nF to 3.3 μ F.

5) Poor layout techniques associated with the RF coupling components may result in high frequency signals bypassing the coupler. This could result in stability problems due to the reduction in the coupler loss.

APPLICATIONS INFORMATION

Determining External Loop Gain and Bandwidth

The external loop voltage gain contributed by the RF channel and RF feedback coupling network should be measured in a closed-loop configuration. A voltage step is applied to PCTL and the change in $V_{PCA/B}$ is measured. The detected voltage is $K \cdot PCTL$, where K is the internal gain between PCTL and the RF pin, and the external voltage gain contributed by the RF power amplifier and RF feedback coupling network is $K \cdot \Delta V_{PCTL} / \Delta V_{VPC}$. Measuring voltage gain in the closed-loop configuration accounts for the nonlinear detector gain that is dependent on RF input voltage and frequency.

The LTC4400-X unity gain bandwidth specified in the data sheet assumes that the net voltage gain contributed by the RF power amplifier and RF feedback coupler is unity. The bandwidth is calculated by measuring the rise time between 10% and 90% of the voltage change at $V_{PCA/B}$ for a small step in voltage applied to PCTL.

$$BW1 = 0.35/\text{rise time}$$

The LTC4400-X control amplifier unity gain bandwidth (BW1) is typically 450kHz below a PCTL voltage of 80mV.

For PCTL voltages <80mV, the RF detected voltage is 0.6PCTL. For PCTL voltages >160mV, RF detected voltage is $1.22PCTL - 0.1$. This change in gain is due to an internal compression circuit designed to extend the detector range.

For example, to determine the external RF channel loop voltage gain with the loop closed, apply a 100mV step to PCTL from 300mV to 400mV. $V_{PCA/B}$ will increase to

supply enough feedback voltage to the RF pin to cancel this 100mV step which would be the required detected voltage step of 122mV. $V_{PCA/B}$ changed from 1.5V to 1.561V to create the RF output power change required. The net external voltage gain contributed by the RF power amplifier and RF feedback coupling network can be calculated by dividing the 122mV change at the RF pin by the 61mV change at the $V_{PCA/B}$ pin. The net external voltage gain would then be approximately 2. The loop bandwidth extends to $2 \cdot BW1$. If BW1 is 230kHz, the loop bandwidth increases to approximately 460kHz. The phase margin can be determined from Figures 2 and 3. Repeat the above voltage gain measurement over the full power and frequency range.

External pole frequencies within the loop will further reduce phase margin. The phase margin degradation, due to external and internal pole combinations, is difficult to determine since complex poles are present. Gain peaking may occur, resulting in higher bandwidth and lower phase margin than predicted from the open-loop Bode plot. A low frequency AC SPICE model of the LTC4400-X power controller is included to better determine pole and zero interactions. The user can apply external gains and poles to determine bandwidth and phase margin. DC, transient and RF information cannot be extracted from the present model. The model is suitable for external gain evaluations up to $6 \times$. The 270kHz PCTL input filter limits the bandwidth, therefore, use the RF input as demonstrated in the model. Gain compression is not modeled.

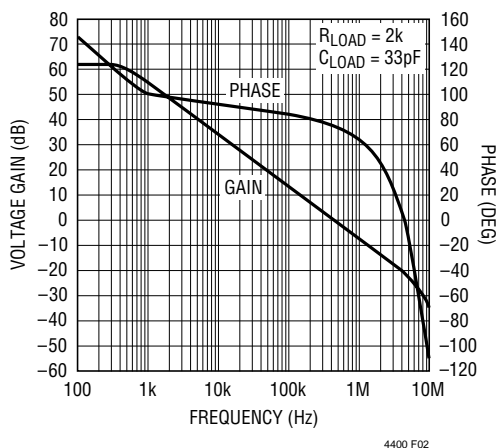

Figure 2. Measured Open-Loop Gain and Phase, PCTL < 80mV

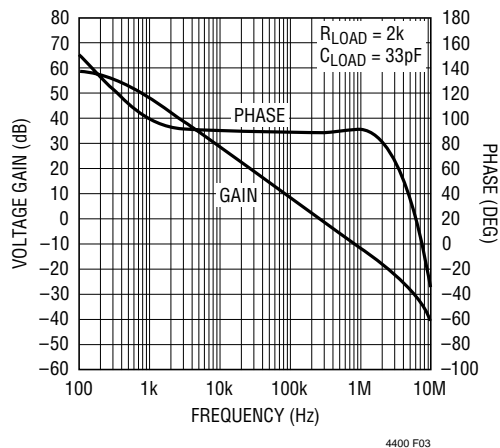

Figure 3. Measured Open-Loop Gain and Phase, PCTL > 160mV

sn4400 4400fas

APPLICATIONS INFORMATION

This model (Figure 6) is being supplied to LTC users as an aid to circuit designs. While the model reflects reasonably close similarity to corresponding devices in low frequency AC performance terms, its use is not suggested as a replacement for breadboarding. Simulation should be used as a forerunner or a supplement to traditional lab testing.

Users should note very carefully the following factors regarding this model: Model performance in general will reflect typical baseline specs for a given device, and certain aspects of performance may not be modeled fully. While reasonable care has been taken in the preparation, we cannot be responsible for correct application on any and all computer systems. Model users are hereby notified that these models are supplied “as is”, with no direct or implied responsibility on the part of LTC for their operation within a customer circuit or system. Further, Linear Technology Corporation reserves the right to change these models without prior notice.

In all cases, the current data sheet information is your final design guideline, and is the only performance guarantee. For further technical information, refer to individual device data sheets. Your feedback and suggestions on this model is appreciated.

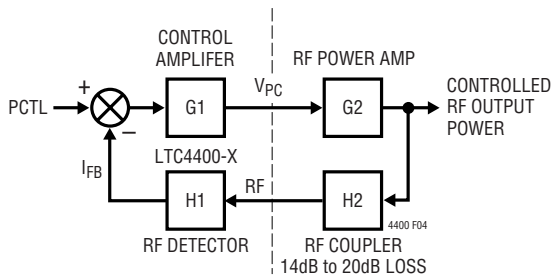

Figure 4. Closed-Loop Block Diagram

Linear Technology Corporation hereby grants the users of this model a nonexclusive, nontransferable license to use this model under the following conditions:

The user agrees that this model is licensed from Linear Technology and agrees that the model may be used, loaned, given away or included in other model libraries as long as this notice and the model in its entirety and unchanged is included. No right to make derivative works or modifications to the model is granted hereby. All such rights are reserved.

This model is provided as is. Linear Technology makes no warranty, either expressed or implied about the suitability or fitness of this model for any particular purpose. In no event will Linear Technology be liable for special, collateral, incidental or consequential damages in connection with or arising out of the use of this model. It should be remembered that models are a simplification of the actual circuit.

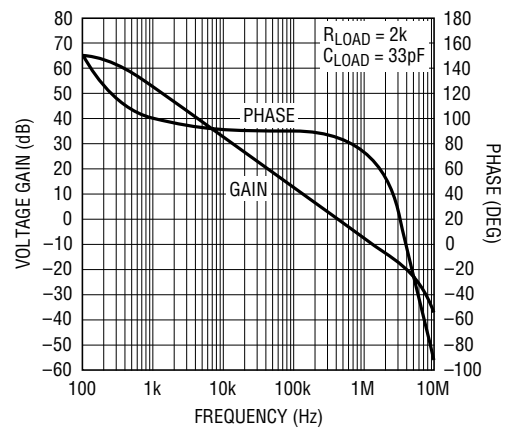

Figure 5. SPICE Model Open-Loop Gain and Phase Characteristics from RF to V_{PCA} , $P_{CTL} < 80mV$

APPLICATIONS INFORMATION

LTC4400-X Low Frequency AC Spice Model

*July 11, 2001

*Main Network Description

GGIN1 ND3 0 ND2 IFB 86E-6

GGXFB IFB 0 0 ND12 33E-6

GGX5 ND11 0 0 ND10 1E-6

GGX6 ND12 0 0 ND11 1E-6

GGX1 ND4 0 0 ND3 1E-6

GGX2 ND6 0 0 ND4 1E-6

GGX3 ND7 0 0 ND6 1E-6

GGX4 ND8 0 0 ND7 1E-6

EEX1 ND9 0 0 ND8 2

CCC1 ND3 0 44E-12

CCPCTL2 ND2 0 7E-12

CCPCTL1 ND1 0 13E-12

CCLint VPCA 0 5E-12

CCLOAD VPCA 0 33E-12

CCFB1 IFB 0 2.4E-12

CCX5 ND11 0 16E-15

CCX6 ND12 0 1.2E-15

CCP ND10 0 28E-12

CCX2 ND6 0 8E-15

CCX3 ND7 0 32E-15

LLX1 ND5 0 80E-3

RR01 ND3 0 20E6

RRFILT ND2 ND1 44E3

RRPCTL1 PCTL ND1 51E3

RRPCTL2 ND1 0 38E3

RR9 VPCA ND9 50

RRLOAD VPCA 0 2E3

RRFB1 IFB 0 22E3

RRT RF 0 250

RRX5 ND11 0 1E6

RRX6 ND12 0 1E6

RRSDRF ND10 500

RRX1 ND4 ND5 1E6

RRX2 ND6 0 1E6

RRX3 ND7 0 1E6

RRX4 ND8 0 1E6

Closed-loop feedback, comment-out VPCTLO, VRF, Adjust EFB gain to reflect external gain, currently set at 3X

*EFB RF 0 VPCA VIN 3

*VIN VIN 0 DC 0 AC 1

*VPCTLO PCTL 0 DC 0

Open-loop connections, comment-out EFB, VIN and VPCTLO***

VPCTLO PCTL 0 DC 0

VRF RF 0 DC 0 AC 1

*****Add AC statement and print statement as required***

.AC DEC 50 100 1E7

*****for PSPICE only*****

.OP

.PROBE

.END

Figure 6. LTC4400-X Low Frequency AC SPICE Model

APPLICATIONS INFORMATION

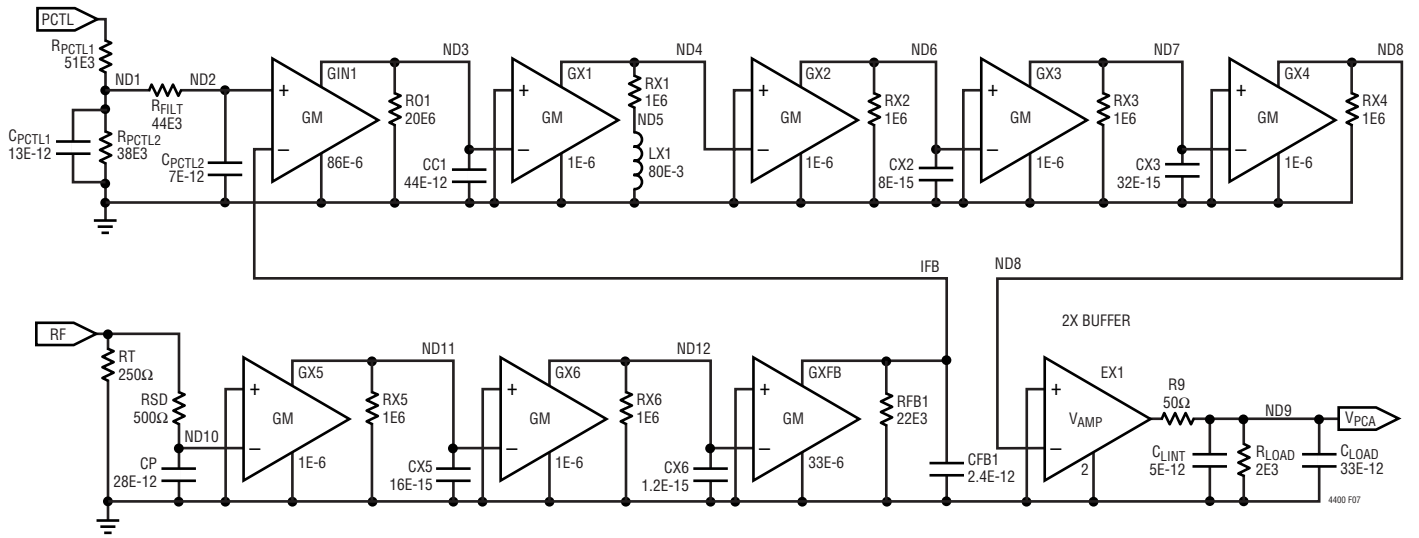
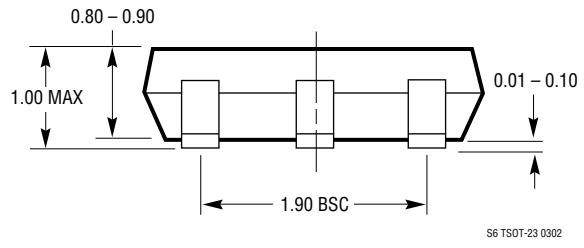
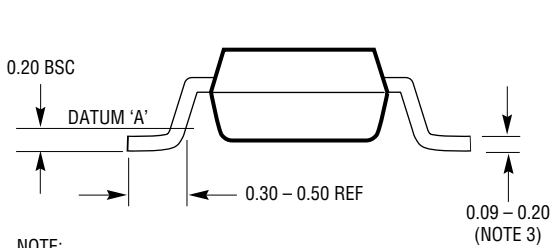
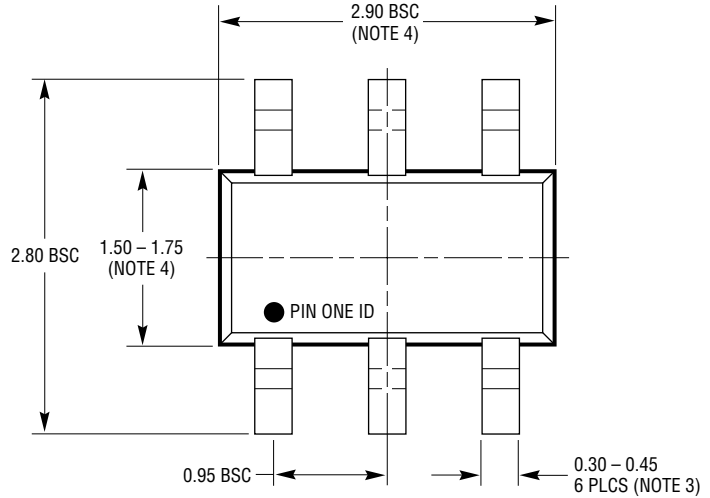
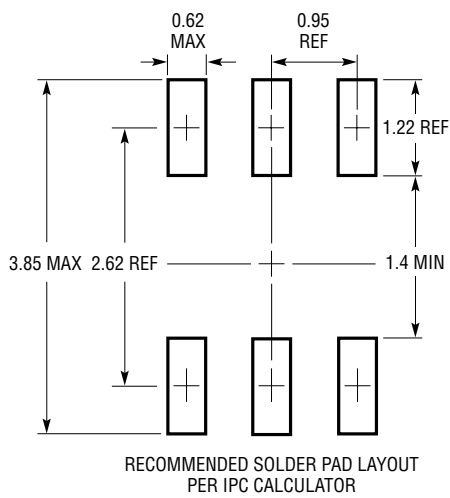

Figure 7. LTC4400-X Low Frequency AC Model

PACKAGE DESCRIPTION

S6 Package
6-Lead Plastic TSOT-23
 (Reference LTC DWG # 05-08-1636)



- NOTE:
1. DIMENSIONS ARE IN MILLIMETERS
 2. DRAWING NOT TO SCALE
 3. DIMENSIONS ARE INCLUSIVE OF PLATING
 4. DIMENSIONS ARE EXCLUSIVE OF MOLD FLASH AND METAL BURR
 5. MOLD FLASH SHALL NOT EXCEED 0.254mm
 6. JEDEC PACKAGE REFERENCE IS MO-193

S6 TSOT-23 0302

PACKAGE DESCRIPTION

MS8 Package
8-Lead Plastic MSOP
 (Reference LTC DWG # 05-08-1660)

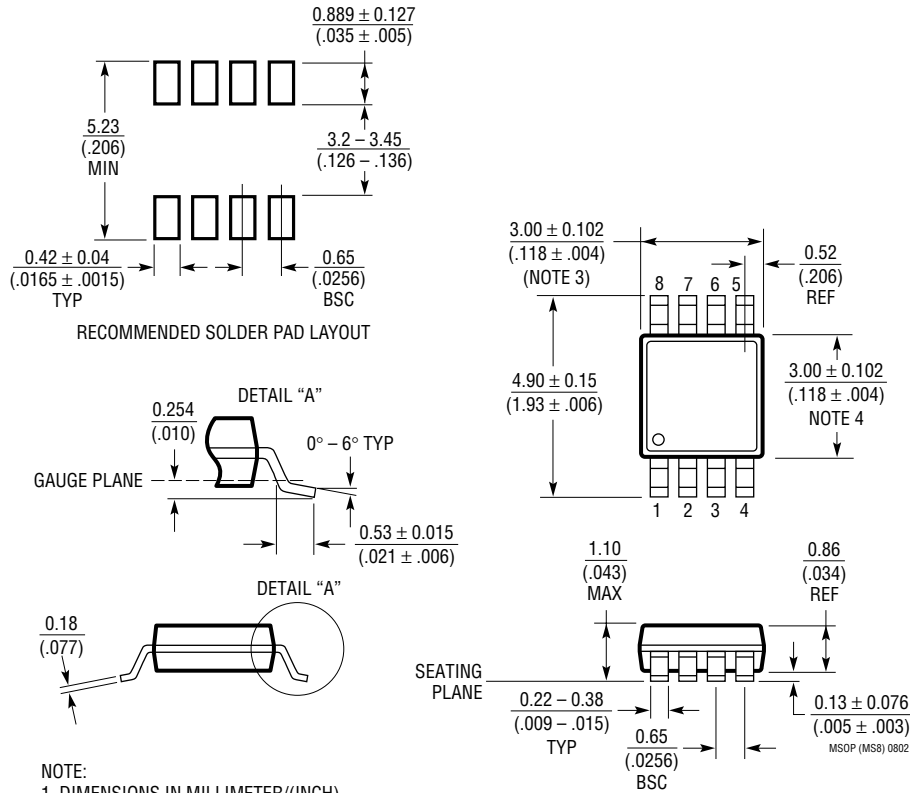

- NOTE:
1. DIMENSIONS IN MILLIMETER/(INCH)
 2. DRAWING NOT TO SCALE
 3. DIMENSION DOES NOT INCLUDE MOLD FLASH, PROTRUSIONS OR GATE BURRS.
MOLD FLASH, PROTRUSIONS OR GATE BURRS SHALL NOT EXCEED 0.152mm (.006") PER SIDE
 4. DIMENSION DOES NOT INCLUDE INTERLEAD FLASH OR PROTRUSIONS.
INTERLEAD FLASH OR PROTRUSIONS SHALL NOT EXCEED 0.152mm (.006") PER SIDE
 5. LEAD COPLANARITY (BOTTOM OF LEADS AFTER FORMING) SHALL BE 0.102mm (.004") MAX

TYPICAL APPLICATION

LTC4400-2 Dual Band Cellular Telephone Transmitter

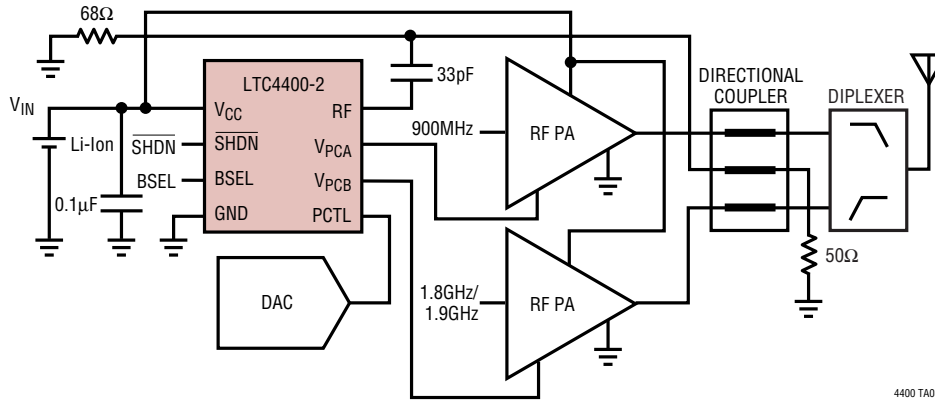

4400 TA03

RELATED PARTS

PART NUMBER	DESCRIPTION	COMMENTS
LTC1261	Regulated Inductorless Voltage Inverter	Regulated $-5V$ from $3V$, REG Pin Indicates Regulation, Up to $15mA$, Micropower
LTC1732	Li-Ion Linear Charger	Complete Linear Charger for 1- and 2-Cell Li-Ion Battery
LTC1734/LTC1734L	ThinSOT Li-Ion Battery Charger	Only Two External Components, No Reverse Current Protection Diode Required, No Sense Resistor Required, PROG Voltage for Charge Termination
LTC1754	ThinSOT Charge Pump	$2V \leq V_{IN} \leq 4V$, $I_{OUT} = 40mA$, No Inductors for White LED Backlight
LTC1757A	RF Power Controller	Single/Dual Band GSM/DCS/GPRS Mobile Phones
LTC1758	RF Power Controller	Single/Dual Band GSM/DCS/GPRS Mobile Phones
LTC1957	RF Power Controller	Single/Dual Band GSM/DCS/GPRS Mobile Phones
LTC4052	Li-Ion Pulse Charger	Complete Pulse Charger for 1-Cell Li-Ion Battery
LTC4401	SOT-23 RF PA Controller	Multiband GSM/DCS/GPRS Phones, $45dB$ Dynamic Range, $250kHz$ Loop BW
LT [®] 5500	1.8GHz to 2.7GHz Receiver Front End	Dual LNA Gain Setting $+13.5dB/-14dB$ at $2.5GHz$, Double-Balanced Mixer, $1.8V \leq V_{SUPPLY} \leq 5.25V$
LT5502	400MHz Quadrature IF Demodulator with RSSI	$70MHz$ to $400MHz$ IF, $1.8V \leq V_{SUPPLY} \leq 5.25V$, $84dBm$ Limiting Gain, $90dB$ RSSI Range
LT5503	1.2GHz to 2.7GHz Direct IQ Modulator with Mixer	Direct IQ Modulator with Integrated 90° Phase Shifter, 4-Step RF Power Control, $1.8V \leq V_{SUPPLY} \leq 5.25V$
LT5504	800MHz to 2.7GHz RF Measuring Receiver	$80dB$ Dynamic Range, Temperature Compensated, $2.7V$ to $5.5V$ Supply
LTC5505	300MHz to 3.5GHz RF Power Detector	$>40dB$ Dynamic Range, Temperature Compensated, $2.7V$ to $6V$ Supply
LTC5507	100kHz to 1GHz RF Power Detector	$40dB$ Dynamic Range, Temperature Compensated, $2.7V$ to $6V$ Supply
LTC5508	300MHz to 7GHz RF Power Detector	$40dB$ Dynamic Range, $2.7V$ to $6V$ Supply, SC70 Package
LT5511	High Signal Level Up Converting Mixer	RF Output to $3GHz$, $17dBm$ IIP3, Integrated LO Buffer
LT5512	High Signal Level Down Converting Mixer	DC- $3GHz$ RF Input, $20dBm$ IIP3, Integrated LO Buffer

sn4400 4400fas