

Optocoupler, Phototransistor Output (Dual, Quad Channel)

Features

- Identical Channel to Channel Footprint
- Dual and Quad Packages Feature:
 - Reduced Board Space
 - Lower Pin and Parts Count
 - Better Channel to Channel CTR Match
 - Improved Common Mode Rejection
- Isolation Test Voltage from Double Molded Package, 5300 V_{RMS}
- Lead-free component
- Component in accordance to RoHS 2002/95/EC and WEEE 2002/96/EC

Agency Approvals

- UL1577, File No. E52744 System Code H or J, Double Protection
- CSA 93751
- BSI IEC60950 IEC60965
- DIN EN 60747-5-2 (VDE0884)
DIN EN 60747-5-5 pending
Available with Option 1

Dual Channel

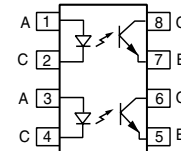
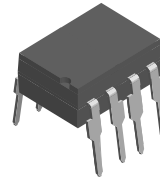

Quad Channel

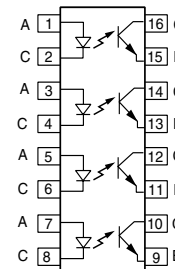
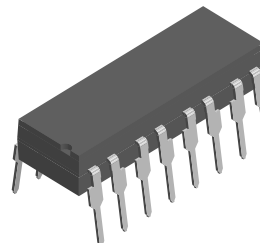

Description

The ILD615/ ILQ615 are multi-channel phototransistor optocouplers that use GaAs IRLED emitters and high gain NPN phototransistors. These devices are constructed using over/under leadframe optical coupling and double molded insulation technology resulting in a withstand test voltage of 7500 V_{AC}_{PEAK} and a working voltage of 1700 V_{RMS}.

The binned min./max. and linear CTR characteristics make these devices well suited for DC or AC voltage detection. Eliminating the phototransistor base connection provides added electrical noise immunity from the transients found in many industrial control environments.

Because of guaranteed maximum non-saturated and saturated switching characteristics, the ILD615/ ILQ615 can be used in medium speed data I/O and control systems. The binned min./max. CTR specification allow easy worst case interface calculations for

both level detection and switching applications. Interfacing with a CMOS logic is enhanced by the guaranteed CTR at I_F = 1.0 mA.

Order Information

Part	Remarks
ILD615-1	CTR 40 - 80 %, Dual Channel, DIP-8
ILD615-2	CTR 63 - 125 %, Dual Channel, DIP-8
ILD615-3	CTR 100 - 200 %, Dual Channel, DIP-8
ILD615-4	CTR 160 - 320 %, Dual Channel, DIP-8
ILQ615-1	CTR 40 - 80 %, Quad Channel, DIP-16
ILQ615-2	CTR 63 - 125 %, Quad Channel, DIP-16
ILQ615-3	CTR 100 - 200 %, Quad Channel, DIP-16
ILQ615-4	CTR 160 - 320 %, Quad Channel, DIP-16
ILD615-1X007	CTR 40 - 80 %, Dual Channel, SMD-8 (option 7)
ILD615-2X006	CTR 63 - 125 %, Dual Channel, DIP-8 400 mil (option 6)
ILD615-2X009	CTR 63 - 125 %, Dual Channel, SMD-8 (option 9)
ILD615-3X006	CTR 100 - 200 %, Dual Channel, DIP-8 400 mil (option 6)
ILD615-3X007	CTR 100 - 200 %, Dual Channel, SMD-8 (option 7)
ILD615-3X009	CTR 100 - 200 %, Dual Channel, SMD-8 (option 9)
ILD615-4X006	CTR 160 - 320 %, Dual Channel, DIP-8 400 mil (option 6)
ILD615-4X009	CTR 160 - 320 %, Dual Channel, SMD-8 (option 9)
ILQ615-1X009	CTR 40 - 80 %, Quad Channel, SMD-16 (option 9)
ILQ615-2X007	CTR 63 - 125 %, Quad Channel, SMD-16 (option 7)
ILQ615-3X006	CTR 100 - 200 %, Quad Channel, DIP-16 400 mil (option 6)
ILQ615-3X009	CTR 100 - 200 %, Quad Channel, SMD-16 (option 9)
ILQ615-4X007	CTR 160 - 320 %, Quad Channel, SMD-16 (option 7)
ILQ615-4X009	CTR 160 - 320 %, Quad Channel, SMD-16 (option 9)

For additional information on the available options refer to
Option Information.



Absolute Maximum Ratings

$T_{amb} = 25\text{ }^{\circ}\text{C}$, unless otherwise specified

Stresses in excess of the absolute Maximum Ratings can cause permanent damage to the device. Functional operation of the device is not implied at these or any other conditions in excess of those given in the operational sections of this document. Exposure to absolute Maximum Rating for extended periods of the time can adversely affect reliability.

Input

Parameter	Test condition	Symbol	Value	Unit
Reverse voltage		V_R	6.0	V
Forward current		I_F	60	mA
Surge current		I_{FSM}	1.5	A
Power dissipation		P_{diss}	100	mW
Derate linearly from 25 °C			1.33	mW/°C

Output

Parameter	Test condition	Symbol	Value	Unit
Collector-emitter breakdown voltage		BV_{CEO}	70	V
Emitter-collector breakdown voltage		BV_{ECO}	7.0	V
Collector current		I_C	50	mA
	$t < 1.0\text{ ms}$	I_C	100	mA
Power dissipation		P_{diss}	150	mW
Derate linearly from 25 °C			2.0	mW/°C

Coupler

Parameter	Test condition	Symbol	Value	Unit
Storage temperature		T_{stg}	- 55 to + 150	°C
Operating temperature		T_{amb}	- 55 to + 100	°C
Junction temperature		T_j	100	°C
Soldering temperature	2.0 mm distance from case bottom	T_{sld}	260	°C
Package power dissipation, ILD615			400	mW
Derate linearly from 25 °C			5.33	mW/°C
Package power dissipation, ILQ615			500	mW
Derate linearly from 25 °C			6.67	mW/°C
Isolation test voltage	$t = 1.0\text{ sec.}$	V_{ISO}	5300	V_{RMS}
Creepage			≥ 7.0	mm
Clearance			≥ 7.0	mm
Isolation resistance	$V_{IO} = 500\text{ V}, T_{amb} = 25\text{ }^{\circ}\text{C}$	R_{IO}	$\geq 10^{12}$	Ω
	$V_{IO} = 500\text{ V}, T_{amb} = 100\text{ }^{\circ}\text{C}$	R_{IO}	$\geq 10^{11}$	Ω

Electrical Characteristics

$T_{amb} = 25\text{ }^{\circ}\text{C}$, unless otherwise specified

Minimum and maximum values are testing requirements. Typical values are characteristics of the device and are the result of engineering evaluation. Typical values are for information only and are not part of the testing requirements.

Input

Parameter	Test condition	Symbol	Min	Typ.	Max	Unit
Forward voltage	$I_F = 10\text{ mA}$	V_F	1.0	1.15	1.3	V
Breakdown voltage	$I_R = 10\text{ }\mu\text{A}$	V_{BR}	6.0	30		V
Reverse current	$V_R = 6.0\text{ V}$	I_R		0.01	10	μA
Capacitance	$V_R = 0\text{ V}$, $f = 1.0\text{ MHz}$	C_O		25		pF
Thermal resistance, junction to lead		R_{THJL}		750		K/W

Output

Parameter	Test condition	Symbol	Min	Typ.	Max	Unit
Collector-emitter capacitance	$V_{CE} = 5.0\text{ V}$, $f = 1.0\text{ MHz}$	C_{CE}		6.8		pF
Collector-emitter leakage current, -1, -2	$V_{CE} = 10\text{ V}$	I_{CEO}		2.0	50	nA
Collector-emitter leakage current, -3, -4	$V_{CE} = 10\text{ V}$	I_{CEO}		5.0	100	nA
Collector-emitter breakdown voltage	$I_{CE} = 0.5\text{ mA}$	BV_{CEO}	70			V
Emitter-collector breakdown voltage	$I_E = 0.1\text{ mA}$	BV_{ECO}	7.0			V
Thermal resistance, junction to lead		R_{THJL}		500		K/W
Package transfer characteristics						
Channel/Channel CTR match	$I_F = 10\text{ mA}$, $V_{CE} = 5.0\text{ V}$	CTR _X / CTR _Y	1 to 1		2 to 1	

Coupler

Parameter	Test condition	Symbol	Min	Typ.	Max	Unit
Capacitance (input-output)	$V_{IO} = 0\text{ V}$, $f = 1.0\text{ MHz}$	C_{IO}		0.8		pF
Insulation resistance	$V_{IO} = 500\text{ V}$, $T_A = 25\text{ }^{\circ}\text{C}$	R_S	10^{12}	10^{14}		Ω
Channel to channel isolation			500			VAC

Current Transfer Ratio

Parameter	Test condition	Part	Symbol	Min	Typ.	Max	Unit
Current Transfer Ratio (collector-emitter saturated)	$I_F = 10\text{ mA}$, $V_{CE} = 0.4\text{ V}$	ILD615-1 ILQ615-1	CTR _{CEsat}		25		%
		ILD615-2 ILQ615-2	CTR _{CEsat}		40		%
		ILD615-3 ILQ615-3	CTR _{CEsat}		60		%
		ILD615-4 ILQ615-4	CTR _{CEsat}		100		%

Parameter	Test condition	Part	Symbol	Min	Typ.	Max	Unit
Current Transfer Ratio (collector-emitter)	$I_F = 10 \text{ mA}, V_{CE} = 5.0 \text{ V}$	ILD615-1 ILQ615-1	CTR_{CE}	40	60	80	%
	$I_F = 1.0 \text{ mA}, V_{CE} = 5.0 \text{ V}$	ILD615-2 ILQ615-2	CTR_{CE}	13	30		%
	$I_F = 10 \text{ mA}, V_{CE} = 5.0 \text{ V}$	ILD615-3 ILQ615-3	CTR_{CE}	63	80	125	%
	$I_F = 1.0 \text{ mA}, V_{CE} = 5.0 \text{ V}$	ILD615-4 ILQ615-4	CTR_{CE}	22	45		%
	$I_F = 10 \text{ mA}, V_{CE} = 5.0 \text{ V}$	ILD615-1 ILQ615-1	CTR_{CE}	100	150	200	%
	$I_F = 1.0 \text{ mA}, V_{CE} = 5.0 \text{ V}$	ILD615-2 ILQ615-2	CTR_{CE}	34	70		%
	$I_F = 10 \text{ mA}, V_{CE} = 5.0 \text{ V}$	ILD615-3 ILQ615-3	CTR_{CE}	160	200	320	%
	$I_F = 1.0 \text{ mA}, V_{CE} = 5.0 \text{ V}$	ILD615-4 ILQ615-4	CTR_{CE}	56	90		%

Switching Non-saturated

Parameter	Current	Turn-on time	Rise time	Turn-off time	Fall time	Propagation H-L	Propagation L-H
Test condition	$V_{CC} = 5.0 \text{ V}, R_L = 75 \Omega, 50 \% \text{ of } V_{PP}$						
Symbol	I_F	t_{on}	t_r	t_{off}	t_f	t_{PHL}	t_{PLH}
Unit	mA	μs	μs	μs	μs	μs	μs
ILD615-1	10	3.0	2.0	2.3	2.0	1.1	2.5

Switching Saturated

Parameter	Current	Turn-on time	Rise time	Turn-off time	Fall time	Propagation H-L	Propagation L-H
Test condition	$V_{CC} = 5.0 \text{ V}, R_L = 1.0 \text{ k}\Omega, V_{TH} = 1.5 \text{ V}$						
Symbol	I_F	t_{on}	t_r	t_{off}	t_f	t_{PHL}	t_{PLH}
Unit	mA	μs	μs	μs	μs	μs	μs
ILD615-1 ILQ615-1	20	3.0	2.0	18	11	1.6	8.6
ILD615-2 ILQ615-2	10	4.3	2.8	25	14	2.6	7.2
ILD615-3 ILQ615-3	10	4.3	2.8	25	14	2.6	7.2
ILD615-4 ILQ615-4	5.0	6.0	4.6	25	15	5.4	7.4

Common Mode Transient Immunity

Parameter	Test condition	Symbol	Min	Typ.	Max	Unit
Common mode rejection output high	$V_{CM} = 50 V_{P-P}, R_L = 1.0 \text{ k}\Omega, I_F = 0 \text{ mA}$	CM_H		5000		V/ μs
Common mode rejection output low	$V_{CM} = 50 V_{P-P}, R_L = 1.0 \text{ k}\Omega, I_F = 10 \text{ mA}$	CM_L		5000		V/ μs
Common mode coupling capacitance		C_{CM}		0.01		pF

Typical Characteristics (Tamb = 25 °C unless otherwise specified)

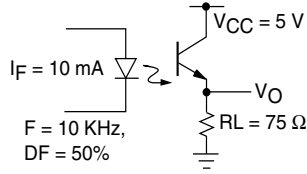

ild615_01

Figure 1. Non-saturated Switching Timing

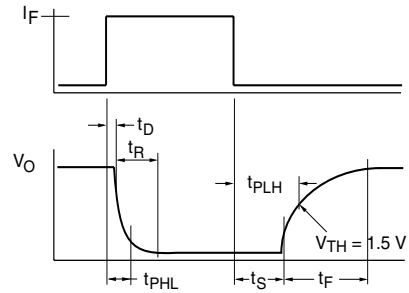

ild615_04

Figure 4. Saturated Switching Timing

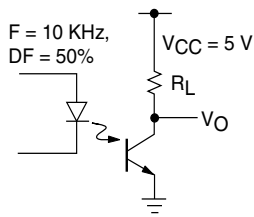

ild615_02

Figure 2. Saturated Switching Timing

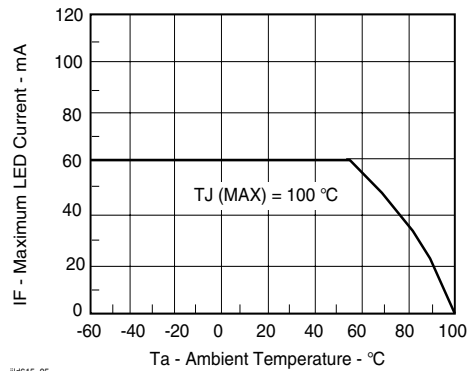

ild615_05

Figure 5. Maximum LED Current vs. Ambient Temperature

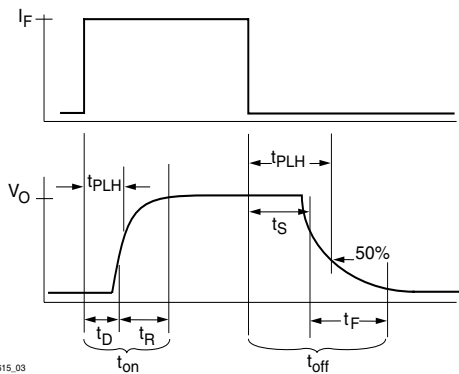

ild615_03

Figure 3. Non-saturated Switching Timing

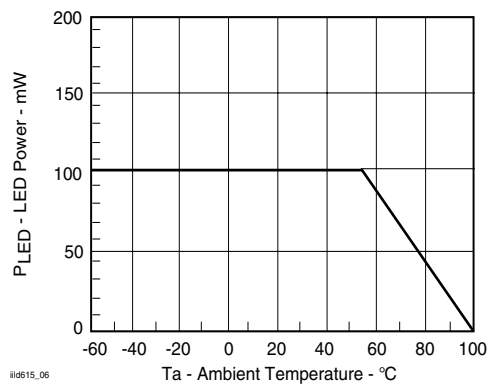

ild615_06

Figure 6. Maximum LED Power Dissipation

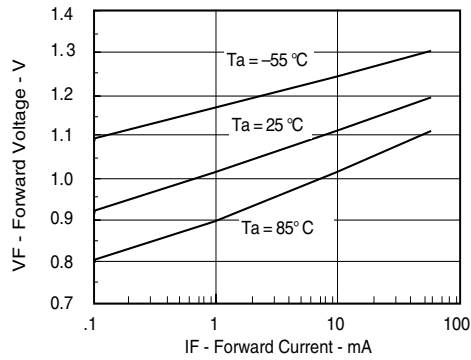

ild615_07

Figure 7. Forward Voltage vs. Forward Current

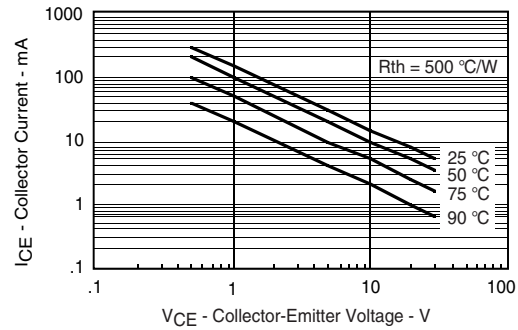

ild615_10

Figure 10. Maximum Collector Current vs. Collector Voltage

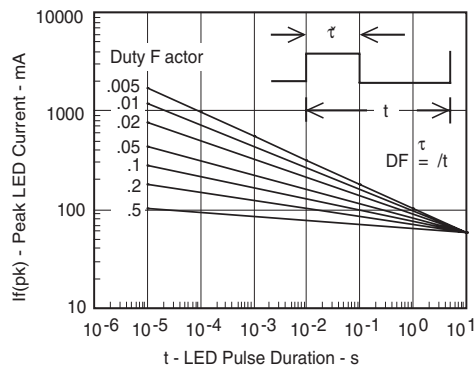

ild615_08

Figure 8. Peak LED Current vs. Pulse Duration, Tau

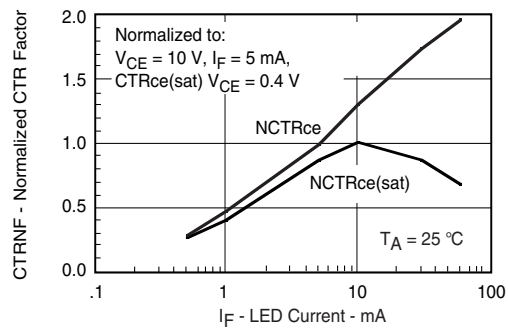

ild615_11

Figure 11. Normalization Factor for Non-saturated and Saturated CTR vs. I_F

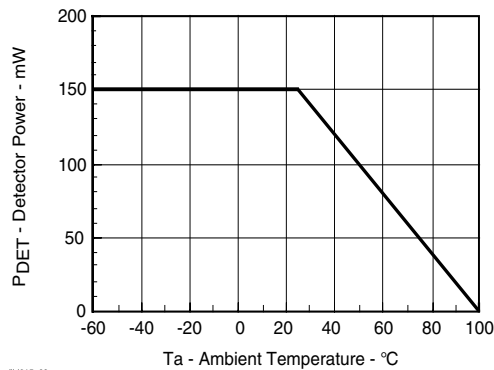

ild615_09

Figure 9. Maximum Detector Power Dissipation

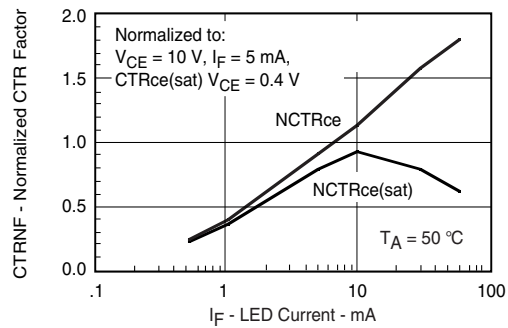

ild615_12

Figure 12. Normalization Factor for Non-saturated and Saturated CTR vs. I_F

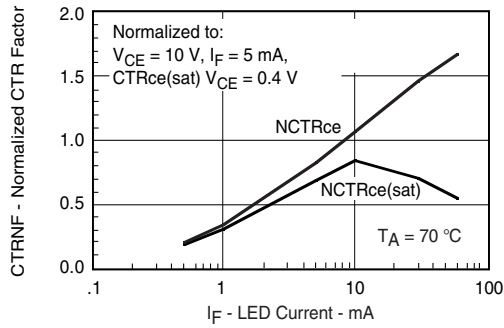

ild615_13

Figure 13. Normalization Factor for Non-saturated and Saturated CTR vs. I_F

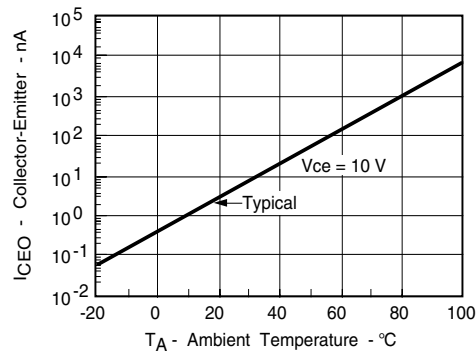

ild615_16

Figure 16. Collector Emitter Leakage vs. Temperature

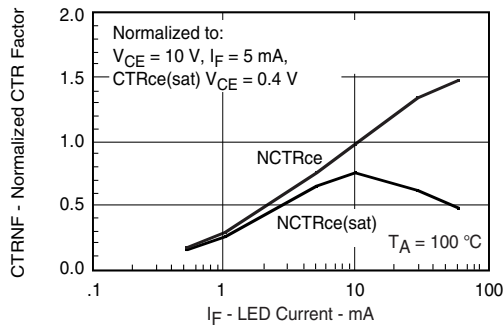

ild615_14

Figure 14. Normalization Factor for Non-saturated and Saturated CTR vs. I_F

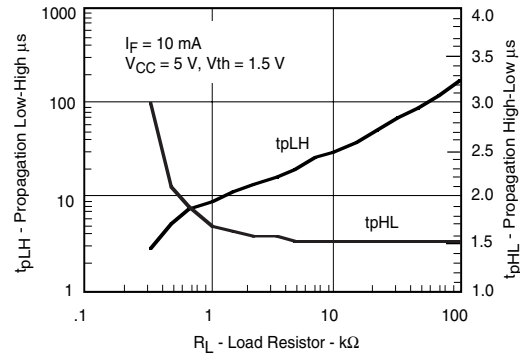

ild615_17

Figure 17. -1, Propagation Delay vs. Collector Load Resistor

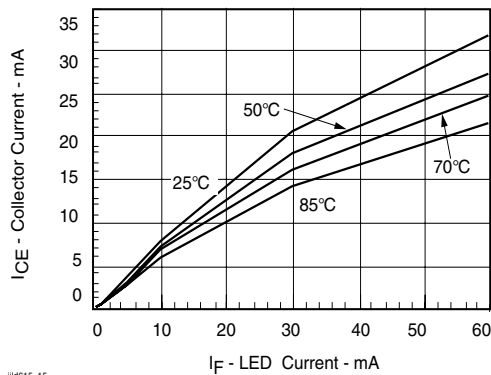

ild615_15

Figure 15. Collector-Emitter Current vs. Temperature and LED Current

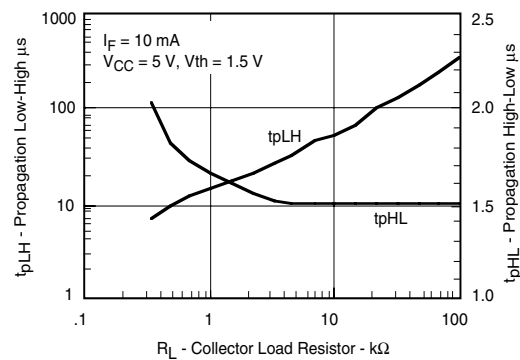

ild615_18

Figure 18. -2, -3, Propagation Delay vs. Collector Load Resistor

Figure 19. -4, Propagation Delay vs. Collector Load Resistor

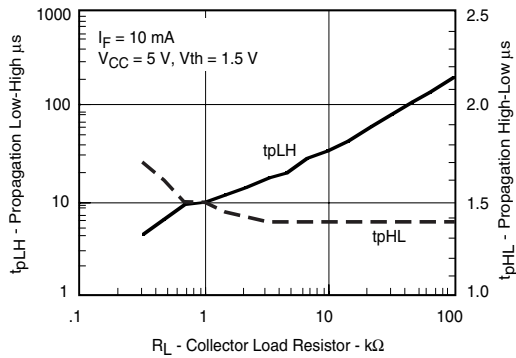

110815_19

Package Dimensions in Inches (mm)

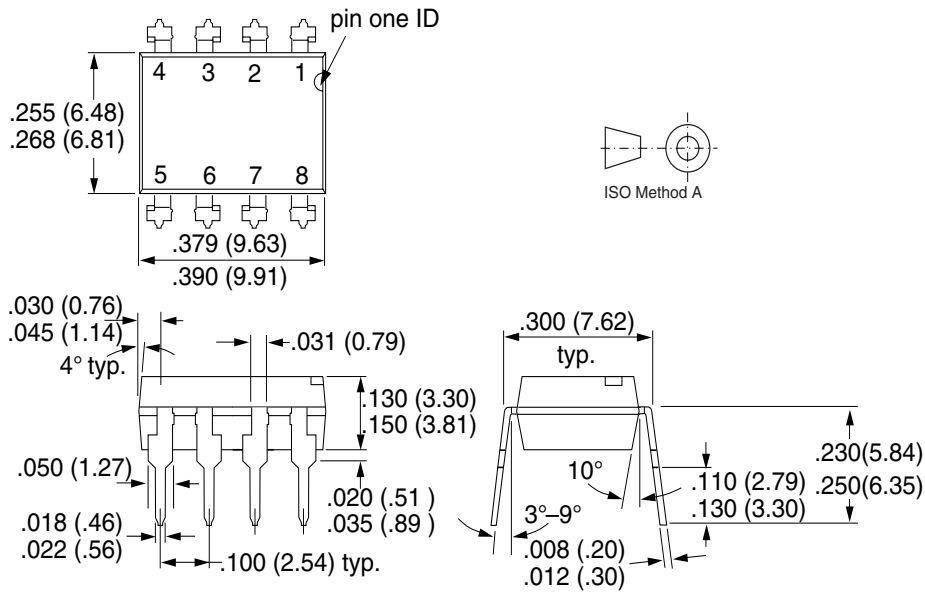

1178006

ILD615/ ILQ615

Vishay Semiconductors



Package Dimensions in Inches (mm)

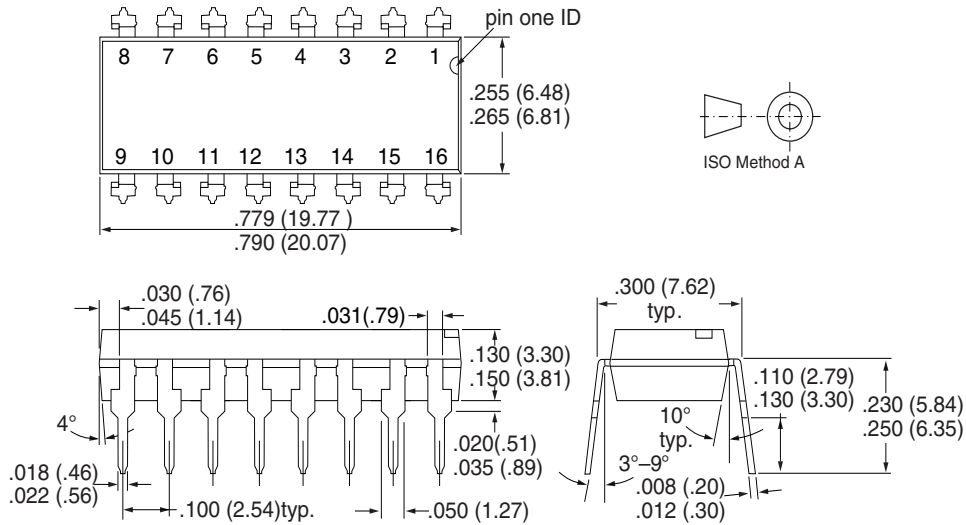

i178007

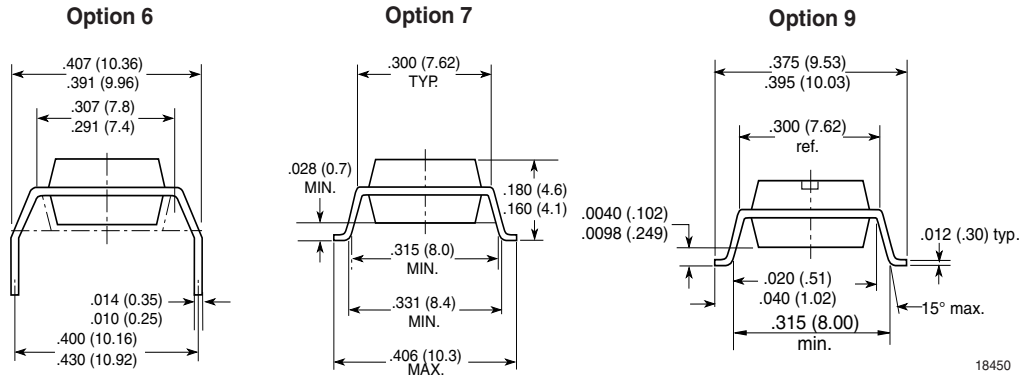

Ozone Depleting Substances Policy Statement

It is the policy of Vishay Semiconductor GmbH to

1. Meet all present and future national and international statutory requirements.
2. Regularly and continuously improve the performance of our products, processes, distribution and operating systems with respect to their impact on the health and safety of our employees and the public, as well as their impact on the environment.

It is particular concern to control or eliminate releases of those substances into the atmosphere which are known as ozone depleting substances (ODSs).

The Montreal Protocol (1987) and its London Amendments (1990) intend to severely restrict the use of ODSs and forbid their use within the next ten years. Various national and international initiatives are pressing for an earlier ban on these substances.

Vishay Semiconductor GmbH has been able to use its policy of continuous improvements to eliminate the use of ODSs listed in the following documents.

1. Annex A, B and list of transitional substances of the Montreal Protocol and the London Amendments respectively
2. Class I and II ozone depleting substances in the Clean Air Act Amendments of 1990 by the Environmental Protection Agency (EPA) in the USA
3. Council Decision 88/540/EEC and 91/690/EEC Annex A, B and C (transitional substances) respectively.

Vishay Semiconductor GmbH can certify that our semiconductors are not manufactured with ozone depleting substances and do not contain such substances.

We reserve the right to make changes to improve technical design and may do so without further notice.

Parameters can vary in different applications. All operating parameters must be validated for each customer application by the customer. Should the buyer use Vishay Semiconductors products for any unintended or unauthorized application, the buyer shall indemnify Vishay Semiconductors against all claims, costs, damages, and expenses, arising out of, directly or indirectly, any claim of personal damage, injury or death associated with such unintended or unauthorized use.

Vishay Semiconductor GmbH, P.O.B. 3535, D-74025 Heilbronn, Germany
Telephone: 49 (0)7131 67 2831, Fax number: 49 (0)7131 67 2423