

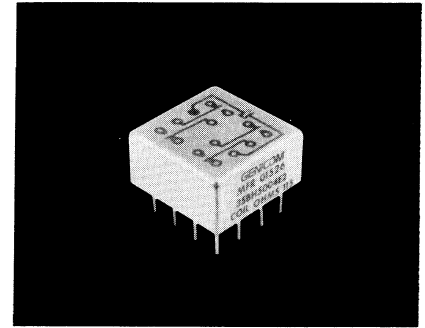

150 Grid-space Micro-miniature Relays



A

Type 3SBH (4PDT)

Features

- Low profile... only 0.32 inch high
- Long life version available
- MIL-R-39016/14

Description

This 150 four pole double throw Grid-space relay is the companion to the two pole 3SBC type shown on page 10. It also features the same .150 inch pin spacing that allows you to insert the relay with no intermediate pin spreaders. There is adequate clearance for conductors to reach all pins. It is a very compact 4 pole double throw 2 ampere relay.

Other Specifications

Contact Ratings:

DC resistive—2 amps at 28 volts
 DC inductive—0.5 amps at 28 volts, 200 mH
 AC resistive—0.5 amps at 115 volts, 400 or 60 Hz (enclosure isolated from ground, or enclosure and movable contact at same potential)
 AC 0.125 amps at 115 volts (enclosure at line potential with respect to movable contact)
 Low level—low-level operation at 50 millivolts, 30 microamps, 33-ohm miss level

Contact Resistance:

0.050 ohms max.; 0.150 ohms after life test

Life:

100,000 operations at rated loads listed; 1,000,000, operations at low-level loads

Operate Time:

4 ms max.

Release Time:

4 ms max.

Bounce:

1.5 millisecond

Dielectric Strength:

500 volts rms at sea level; 350 volts rms at 70,000 feet

Insulation Resistance:

1,000 megohms minimum over temperature range

Vibration:

30G, to 3000 Hz

Shock:

100G at 11 ms

Temperature:

– 65C to +125C

See page 19 for Mounting Forms, Terminals and Circuit Diagrams.

F B

Coil Table (All Values DC)* Type 3SBH, 4 Pole Relay — 250 mW Sensitivity: (Code 1)

SENSITIVITY CODE: 1					
Coil Code Letter	Coil Resistance at 25C ohms	Voltage Calibrated, Code: 5			
		Suggested Source Volts†	Maximum Operate Volts at 25C	Release Voltage Range at 25C	
				Max.	Min.
B	28 ± 10%	4.0- 7.0	2.7	1.6	0.3
D	73 ± 10%	6.0-11.0	4.2	2.5	0.4
E	115 ± 10%	8.0-14.0	5.4	3.2	0.6
G	280 ± 10%	12 -22.0	8.4	5.0	0.8
H	430 ± 10%	15 -26.0	10.3	6.0	1.0
K	720 ± 10%	20 -35.0	13.5	8.1	1.5
N	1040 ± 10%	26 -46.0	17.5	10.5	1.9

* Values listed are Factory test and inspection values. User should allow for meter variations. † Applicable over the operating temperature range in circulating air.

E

ORDERING INSTRUCTIONS

Catalog-selected Relays: The catalog number is derived by choosing the proper CODE for each of the six relay characteristics in the order in which the codes are listed. Use the location guide (letters in vertical red columns) to find each CODE easily.

Example: The relay selected in this example is a 4PDT 150-grid relay, voltage calibrated end bracket mounting, 0.13-inch solder hook header, 720 ohms coil resistance, and 250 mW sensitivity. By choosing the proper code for each of these relay characteristics, the catalog number is identified as 35BH5131K5. The letter R following sensitivity code indicates relay received 5000 operation miss-test. Ex. 35BH5131K5R

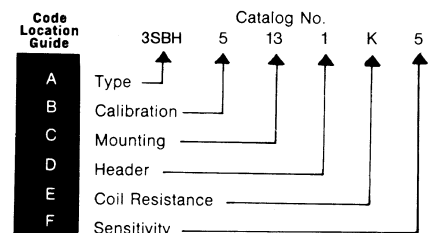

150 Grid-space Hybrid Micro-miniature Relays

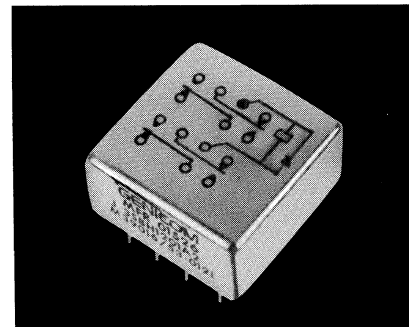

Type 3SBH (4PDT)

Features

- Low profile... only 0.32 inch high
- Long life version available
- MIL-R-39016/53 & 54

Description

The 4PDT .150 Grid-space hybrid relays are advanced designs of the standard high reliability 4PDT .150 Grid-space relays. In the single diode version, the relay coil-back electromotive force is suppressed to prevent circuit/component damage. With the dual diode version, a steering diode is added to the coil circuit, along with the suppression diode. This steering diode prevents operation of the relay by reverse polarity voltages and protects the suppression diode. The single diode version is qualified to MIL-R-39016/53 and the dual diode is qualified to MIL-R-39016/54.

Other Specifications

Contact Ratings:

DC resistive—2 amps at 28 volts
 DC inductive—0.5 amps at 28 volts, 200 mH
 AC resistive—0.5 amps at 115 volts, 400 or 60 Hz (enclosure isolated from ground, or enclosure and movable contact at same potential)
 AC 0.125 amps at 115 volts (enclosure at line potential with respect to movable contact)
 Low-level—50 μ A at 50 mV
 Peak AC or DC

Contact Resistance:

0.050 ohms max.;
 0.150 ohms after life test

Life:

100,000 operations at rated loads listed;
 1,000,000, operations at low-level loads

Operate Time:

4 ms max.

Release Time:

6 ms max.

Bounce:

2.0 millisecond

Dielectric Strength: Note (1)

500 volts rms at sea level;
 350 volts rms at 70,000 feet

Insulation Resistance: Note (1)

1,000 megohms minimum over temperature range

Semiconductor Characteristics at 25C:

Max. Negative Transient: 1 volt
 Breakdown voltage: 100VDC @ 10 μ A Minimum
 Max. Leakage Current: 1 microamp @ 50VDC

Note (1): Tests for dielectric withstanding voltage and insulation resistance should be made with "coil terminals" shorted together to avoid unnecessary electrical stress to semiconductor elements.

See page 19 for Mounting Forms, Terminals and Circuit Diagrams.

Coil Table (All Values DC)* Type 3SBH, 4 Pole Relay — 250 mW Sensitivity: (Code 5 single diode, Code 6 dual diodes)

Single Diode		SENSITIVITY CODE: 5			
Coil Code Letter	Coil Resistance at 25C ohms	Voltage Calibrated, Code: 5			
		Suggested Source Volts†	Maximum Operate Volts at 25C	Release Voltage Range at 25C	
				Max.	Min.
B	28 \pm 10%	4.0- 7.0	2.7	1.6	0.3
D	73 \pm 10%	6.0-11.0	4.2	2.5	0.4
E	115 \pm 10%	8.0-14.0	5.4	3.2	0.6
G	280 \pm 10%	12 -22.0	8.4	5.0	0.8
H	430 \pm 10%	15 -26.0	10.3	6.0	1.0
K	720 \pm 10%	20 -35.0	13.5	8.1	1.5
N	1040 \pm 10%	26 -46.0	17.5	10.5	1.9
Dual Diode		SENSITIVITY CODE: 6			
B	28 \pm 10%	4.0- 7.0	3.7	2.3	0.5
D	73 \pm 10%	6.0-11.0	5.2	3.2	0.6
E	115 \pm 10%	8.0-14.0	6.4	3.9	0.8
G	280 \pm 10%	12.0-22.0	9.4	5.7	1.0
H	430 \pm 10%	15 -26.0	11.3	6.7	1.2
K	720 \pm 10%	20 -35.0	14.5	8.8	1.7
N	1040 \pm 10%	26 -46.0	18.1	11.1	2.1

*Values listed are factory test and inspection values. User should allow for meter variations.

†Applicable over the operating temperature range in circulating air.



Long-life 150 Grid-space Micro-miniature Relays

100,000,000 Operations At Low Levels

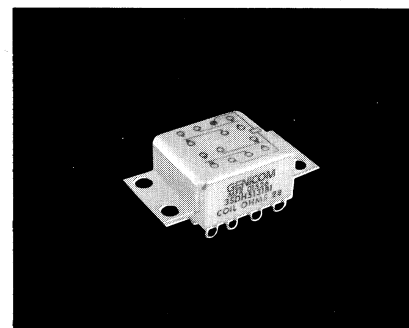

A

Type 3SDH (4PDT)

Features

- Long life at low level or signal loads.
- Low profile... only 0.32 inch high

Description

The 3SDH relay is designed for 100,000,000 operations at low levels. It is a four pole double throw Grid-spaced relay. The 0.150 inch pin spacing allows the user to insert the relay with no intermediate pin spreaders. There is adequate clearance for conductor to reach all pins.

Other Specifications

Contact Ratings:

DC resistive—2 amps at 28 volts,
(DC 100,000 operations)
DC inductive—0.3 amp at 28 volts,
(L/R not greater than 0.008)
AC resistive—0.5 amp at 115 volts, 400
or 60 Hz (enclosure isolated from
ground, or enclosure and movable con-
tact at same potential)
AC resistive 0.125 amps at 115 volts
(enclosure at line potential with respect
to movable contact)
Low-level—50 μ A at 50 mV
Peak AC or DC

Contact Resistance:

0.050 ohms max.; 0.150 ohms after life
tests

Life:

100,000 operations at rated loads lifted;
100,000,000 operations @ low-level loads

Operate Time: @ +25°C
4 ms max.

Release Time: @ +25°C
4 ms max.

Bounce: @ +25°C
1.5 millisecond

Dielectric Strength:
500 volts rms at sea level;
350 volts rms at 70,000 feet

Insulation Resistance:
1,000 megohms minimum over
temperature range

Vibration:
30G, to 3000 Hz

Shock:
100G at 11 ms

Temperature:
–40C to +125C

See page 19 for Mounting Forms,
Terminals and Circuit Diagrams.

F

B

E

Coil Table (All Values DC)*Type 3SDH, 4 Pole Relay—210mW Sensitivity: (Code 1)

SENSITIVITY CODE: 1					
Coil Code Letter	Coil Resistance at 25C ohms	Voltage Calibrated, Code: 5			
		Suggested Source Volts†	Maximum Operate Volts at 25C	Release Voltage Range at 25C	
				Max.	Min.
B	28 \pm 10%	4.0- 7.0	3.0	1.6	0.3
D	73 \pm 10%	6.0-11.0	4.8	2.5	0.4
E	115 \pm 10%	8.0-14.0	5.9	3.2	0.6
G	280 \pm 10%	12 -22.0	9.3	5.0	0.8
H	430 \pm 10%	15 -26.0	11.5	6.0	1.0
K	720 \pm 10%	20 -35.0	14.9	8.1	1.5
N	1040 \pm 10%	26 -46.0	17.9	10.5	1.9

* Values listed are Factory test and inspection values. User should allow for meter variations. † Applicable over the operating temperature range in circulating air.

Mounting Forms (3SBH, 3SDH)

(Vibration note with each form is acceleration from 55 to 3000 Hz)

No Mount

Mounting Code	Vibration*
00	30g

*Assumes relay held securely by potting or other means.

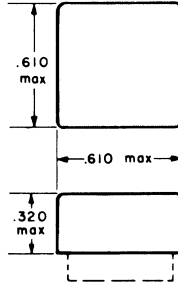

End Bracket

Mounting Code	Vibration
13	30g

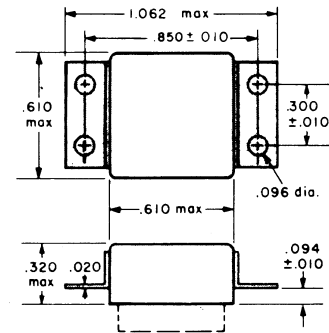

Header Types

Type	Z Dimension	Header Code
Solder hook	0.13	1
Straight pin	0.12	8
Straight pin socket or PCB type	0.19	4
Straight pin	0.25	5

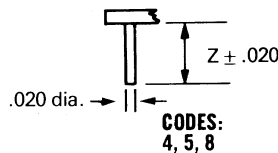
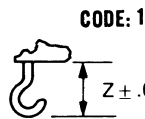

All dimensions in inches

TOLERANCES (Unless otherwise specified)	
Hundredths	±0.020
Thousandths	±0.005

Header and Connection Diagrams

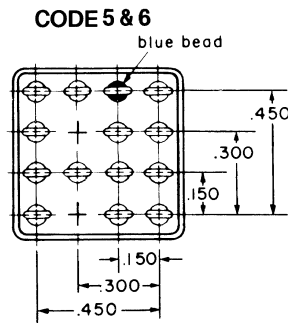
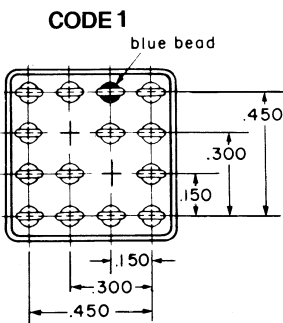
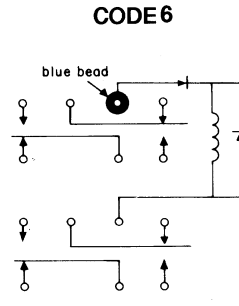
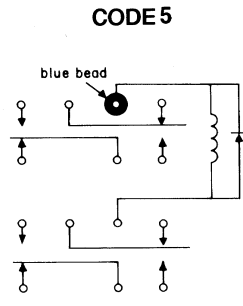
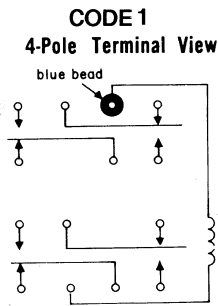

Terminals .020 dia

ORDERING INSTRUCTIONS

Catalog-selected Relays: The catalog number is derived by choosing the proper CODE for each of the six relay characteristics in the order in which the codes are listed. Use the location guide (letters in vertical red columns) to find each CODE easily.

Example: The relay selected in this example is a 4PDT 150-grid relay, voltage calibrated end bracket mounting, 0.13-inch solder hook header, 720 ohms coil resistance, and 250 mW sensitivity. By choosing the proper code for each of these relay characteristics, the catalog number is identified as 35BH5131K5. The letter R following sensitivity code indicates relay received 5000 operation miss-test. Ex. 35BH5131K5R

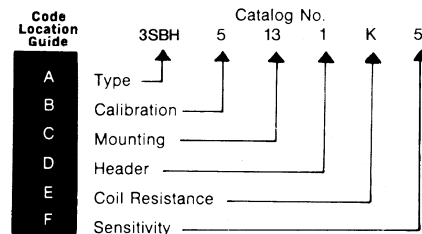

C

D

F