

TOSHIBA MOS DIGITAL INTEGRATED CIRCUIT SILICON GATE CMOS

1,048,576-WORD BY 16-BIT CMOS STATIC RAM

DESCRIPTION

The TC55V16100FTI is a 16,777,216-bit high-speed static random access memory (SRAM) organized as 1,048,576 words by 16 bits. Fabricated using CMOS technology and advanced circuit techniques to provide high speed, it operates from a single 3.3 V power supply. Chip enable (\overline{CE}) can be used to place the device in a low-power mode, and output enable (\overline{OE}) provides fast memory access. Data byte control signals (\overline{LB} , \overline{UB}) provide lower and upper byte access. This device is well suited to cache memory applications where high-speed access and high-speed storage are required. All inputs and outputs are directly LVTTL compatible. It guarantees -40° to 85°C operating temperature so it is suitable for use in wide operating temperature system. The TC55V16100FTI is available in plastic 54-pin TSOP with 400mil width for high density surface assembly.

FEATURES

- Fast access time(the following are maximum values)
 - TC55V16100FTI-12: 12 ns
 - TC55V16100FTI-15: 15 ns
- Low-power dissipation
- Single power supply voltage : $3.3\text{V} \pm 0.3\text{V}$
- Fully static operation
- Operating temperature range : -40° to 85°C
- All inputs and outputs are LVTTL compatible
- Output buffer control using \overline{OE}
- Data byte control using \overline{LB} (I/O1 to I/O8) and \overline{UB} (I/O9 to I/O16)
- Package:
 - TSOP II 54-P-400-0.80B (Weight: 0.55g typ)

Cycle Time	12	15	ns
Operation (max)	420	380	mA

Standby : 4mA(max)

PIN ASSIGNMENT

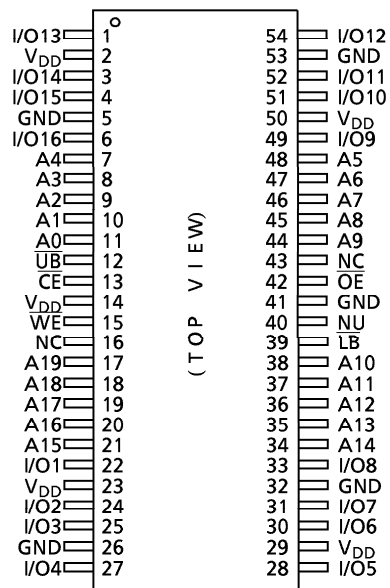

PIN NAMES

A0 to A19	Address Inputs
I/O1 to I/O16	Data Inputs/Outputs
\overline{CE}	Chip Enable Input
\overline{WE}	Write Enable Input
\overline{OE}	Output Enable Input
\overline{LB} , \overline{UB}	Data Byte Control Inputs
V_{DD}	Power (+ 3.3V)
GND	Ground
NC	No Connection
NU	Not Usable

000707EBA2

- TOSHIBA is continually working to improve the quality and reliability of its products. Nevertheless, semiconductor devices in general can malfunction or fail due to their inherent electrical sensitivity and vulnerability to physical stress. It is the responsibility of the buyer, when utilizing TOSHIBA products, to comply with the standards of safety in making a safe design for the entire system, and to avoid situations in which a malfunction or failure of such TOSHIBA products could cause loss of human life, bodily injury or damage to property. In developing your designs, please ensure that TOSHIBA products are used within specified operating ranges as set forth in the most recent TOSHIBA products specifications. Also, please keep in mind the precautions and conditions set forth in the "Handling Guide for Semiconductor Devices," or "TOSHIBA Semiconductor Reliability Handbook" etc..
- The TOSHIBA products listed in this document are intended for usage in general electronics applications (computer, personal equipment, office equipment, measuring equipment, industrial robotics, domestic appliances, etc.). These TOSHIBA products are neither intended nor warranted for usage in equipment that requires extraordinarily high quality and/or reliability or a malfunction or failure of which may cause loss of human life or bodily injury ("Unintended Usage"). Unintended Usage include atomic energy control instruments, airplane or spaceship instruments, transportation instruments, traffic signal instruments, combustion control instruments, medical instruments, all types of safety devices, etc.. Unintended Usage of TOSHIBA products listed in this document shall be made at the customer's own risk.
- The products described in this document are subject to the foreign exchange and foreign trade laws.
- The information contained herein is presented only as a guide for the applications of our products. No responsibility is assumed by TOSHIBA CORPORATION for any infringements of intellectual property or other rights of the third parties which may result from its use. No license is granted by implication or otherwise under any intellectual property or other rights of TOSHIBA CORPORATION or others.
- The information contained herein is subject to change without notice.

BLOCK DIAGRAM

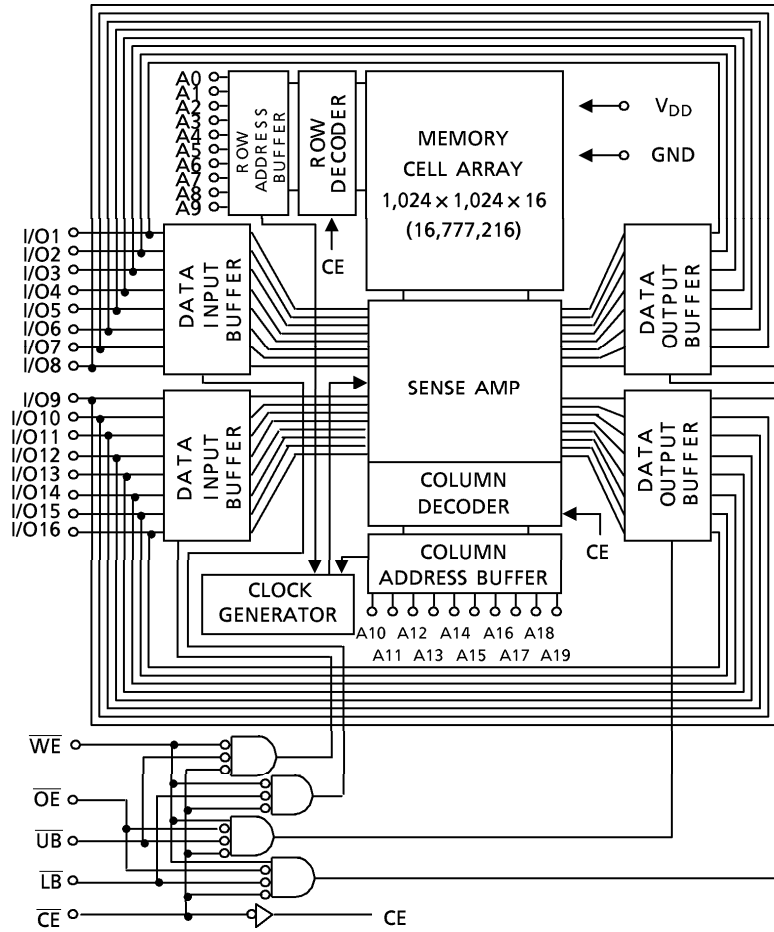

MAXIMUM RATINGS

SYMBOL	RATING	VALUE	UNIT
V _{DD}	Power Supply Voltage	- 0.5 to 4.6	V
V _{IN}	Input Terminal Voltage	- 0.5* to 4.6	V
V _{I/O}	Input/Output Terminal Voltage	- 0.5* to V _{DD} + 0.5**	V
P _D	Power Dissipation	1.8	W
T _{solder}	Soldering Temperature (10 s)	260	°C
T _{strg}	Storage Temperature	- 65 to 150	°C
T _{opr}	Operating Temperature	- 40 to 100	°C

* : -1.5V with a pulse width of 20% · t_{RC} min (4ns max)

** : V_{DD}+1.5V with a pulse width of 20% · t_{RC} min (4ns max)

DC RECOMMENDED OPERATING CONDITIONS (Ta = -40° to 85°C)

SYMBOL	PARAMETER	MIN	TYP	MAX	UNIT
V _{DD}	Power Supply Voltage	3.0	3.3	3.6	V
V _{IH}	Input High Voltage	2.0	-	V _{DD} + 0.3**	V
V _{IL}	Input Low Voltage	- 0.3*	-	0.8	V

* : -1.0V with a pulse width of 20% · t_{RC} min (4ns max)

** : V_{DD}+1.0V with a pulse width of 20% · t_{RC} min (4ns max)

DC CHARACTERISTICS (Ta = -40° to 85°C, V_{DD} = 3.3V ± 0.3V)

SYMBOL	PARAMETER	TEST CONDITION	MIN	TYP	MAX	UNIT	
I _{IL}	Input Leakage Current (Except NU pin)	V _{IN} = 0 to V _{DD}	-1	-	1	μA	
I _{LO}	Output Leakage Current	$\overline{CE} = V_{IH}$ or $\overline{WE} = V_{IL}$ or $\overline{OE} = V_{IH}$ V _{OUT} = 0 to V _{DD}	-1	-	1	μA	
I _{I(NU)}	Input Current (NU pin)	V _{IN} = 0 to 0.8V	-1	-	20	μA	
		V _{IN} = 0 to 0.2V	-1	-	1		
V _{OH}	Output High Voltage	I _{OH} = -2mA	2.4	-	-	V	
		I _{OH} = -100μA	V _{DD} - 0.2	-	-		
V _{OL}	Output Low Voltage	I _{OL} = 2mA	-	-	0.4		
		I _{OL} = 100μA	-	-	0.2		
I _{DDO}	Operating Current	$\overline{CE} = V_{IL}$, I _{out} = 0mA $\overline{OE} = V_{IH}$ Other Inputs = V _{DD} - 0.2V or 0.2V	tcycle = 12ns	-	-	420	mA
			tcycle = 15ns	-	-	380	
I _{DDS1}	Standby Current	$\overline{CE} = V_{IH}$, Other Inputs = V _{IH} or V _{IL}	-	-	105	mA	
I _{DDS2}		$\overline{CE} = V_{DD} - 0.2V$ Other Inputs = V _{DD} - 0.2V or 0.2V	-	-	4		

CAPACITANCE (Ta = 25°C, f = 1.0 MHz)

SYMBOL	PARAMETER	TEST CONDITION	MAX	UNIT
C _{IN}	Input Capacitance	V _{IN} = GND	6	pF
C _{I/O}	Input/Output Capacitance	V _{I/O} = GND	8	pF

Note: This parameter is periodically sampled and is not 100% tested.

OPERATING MODE

MODE	\overline{CE}	\overline{OE}	\overline{WE}	\overline{LB}	\overline{UB}	I/O1 to I/O8	I/O9 to I/O16	POWER
Read	L	L	H	L	L	Output	Output	I _{DDO}
				H	L	High Impedance	Output	I _{DDO}
				L	H	Output	High Impedance	I _{DDO}
Write	L	x	L	L	L	Input	Input	I _{DDO}
				H	L	High Impedance	Input	I _{DDO}
				L	H	Input	High Impedance	I _{DDO}
Outputs Disable	L	H	H	x	x	High Impedance	High Impedance	I _{DDO}
	L	x	x	H	H			
Standby	H	x	x	x	x	High Impedance	High Impedance	I _{DDS}

x: Don't care

Note: The NU pin must be left unconnected or tied to GND or a voltage level of less than 0.8 V.
You must not apply a voltage of more than 0.8 V to the NU.

AC CHARACTERISTICS ($T_a = -40^\circ$ to 85°C (Note 1), $V_{DD} = 3.3\text{V} \pm 0.3\text{V}$)

READ CYCLE

SYMBOL	PARAMETER	TC55V16100FTI-12		TC55V16100FTI-15		UNIT
		MIN	MAX	MIN	MAX	
t_{RC}	Read Cycle Time	12	-	15	-	ns
t_{ACC}	Address Access Time	-	12	-	15	
t_{CO}	Chip Enable Access Time	-	12	-	15	
t_{OE}	Output Enable Access Time	-	6	-	8	
t_{BA}	Upper Byte, Lower Byte Access Time	-	6	-	8	
t_{OH}	Output Data Hold Time from Address Change	3	-	3	-	
t_{COE}	Output Enable Time from Chip Enable	3	-	3	-	
t_{OEE}	Output Enable Time from Output Enable	1	-	1	-	
t_{BE}	Output Enable Time from Upper Byte, Lower Byte	1	-	1	-	
t_{COD}	Output Disable Time from Chip Enable	-	7	-	8	
t_{ODO}	Output Disable Time from Output Enable	-	7	-	8	
t_{BD}	Output Disable Time from Upper Byte, Lower Byte	-	7	-	8	

WRITE CYCLE

SYMBOL	PARAMETER	TC55V16100FTI-12		TC55V16100FTI-15		UNIT
		MIN	MAX	MIN	MAX	
t_{WC}	Write Cycle Time	12	-	15	-	ns
t_{WP}	Write Pulse Width	8	-	10	-	
t_{CW}	Chip Enable to End of Write	9	-	11	-	
t_{BW}	Upper Byte, Lower Byte Enable to End of Write	9	-	11	-	
t_{AW}	Address Valid to End of Write	9	-	11	-	
t_{AS}	Address Setup Time	0	-	0	-	
t_{WR}	Write Recovery Time	0	-	0	-	
t_{DS}	Data Setup Time	7	-	8	-	
t_{DH}	Data Hold Time	0	-	0	-	
t_{OEW}	Output Enable Time from Write Enable	1	-	1	-	
t_{ODW}	Output Disable Time from Write Enable	-	7	-	8	

AC TEST CONDITIONS

Input Pulse Level	3.0V/0.0V
Input Pulse Rise and Fall Time	2ns
Input Timing Measurement Reference Level	1.5V
Output Timing Measurement Reference Level	1.5V
Output Load	Fig. 1

Fig. 1

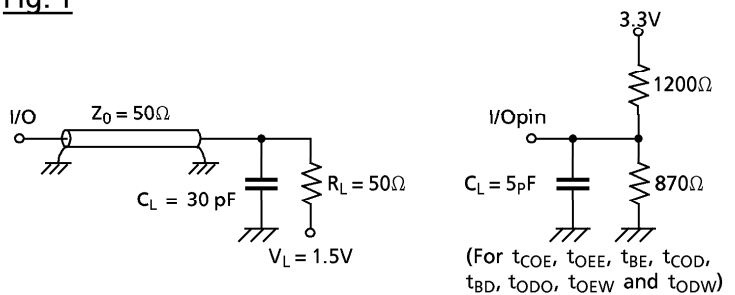

TIMING DIAGRAMS
READ CYCLE (See Note 2)

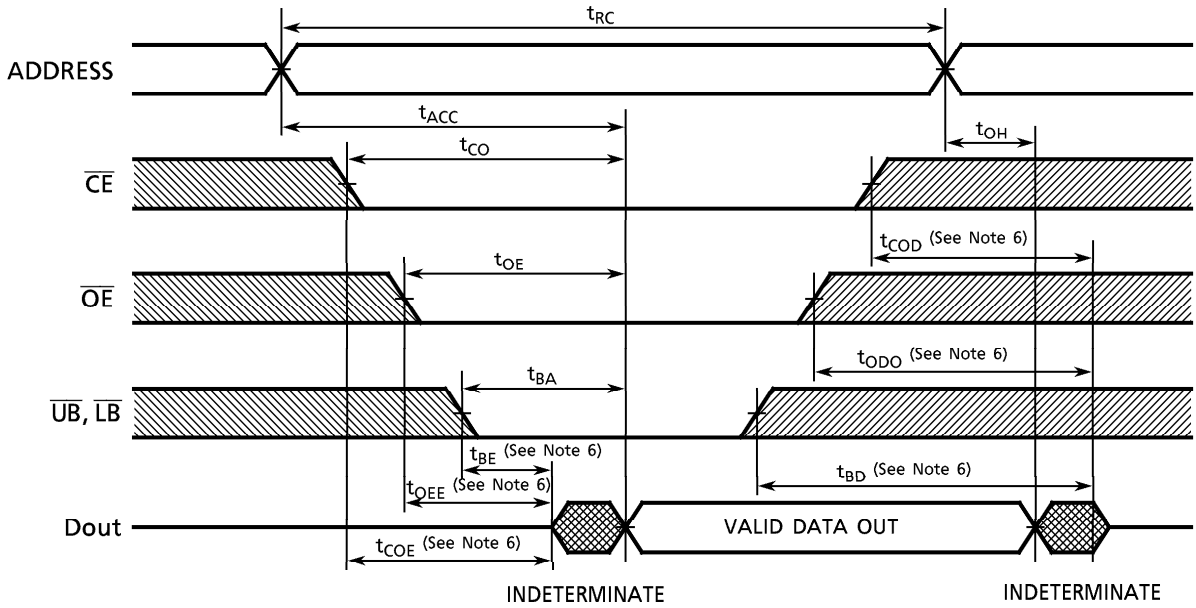

WRITE CYCLE 1 (\overline{WE} CONTROLLED) (See Note 5)

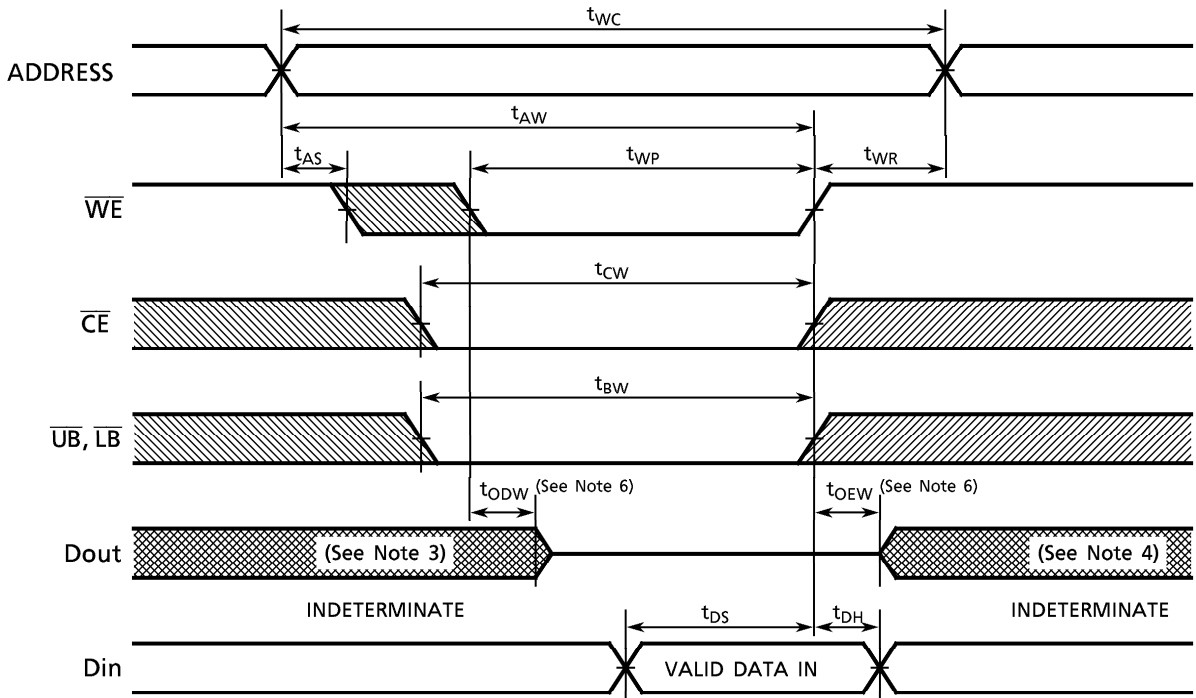

WRITE CYCLE 2 (\overline{CE} CONTROLLED) (See Note 5)

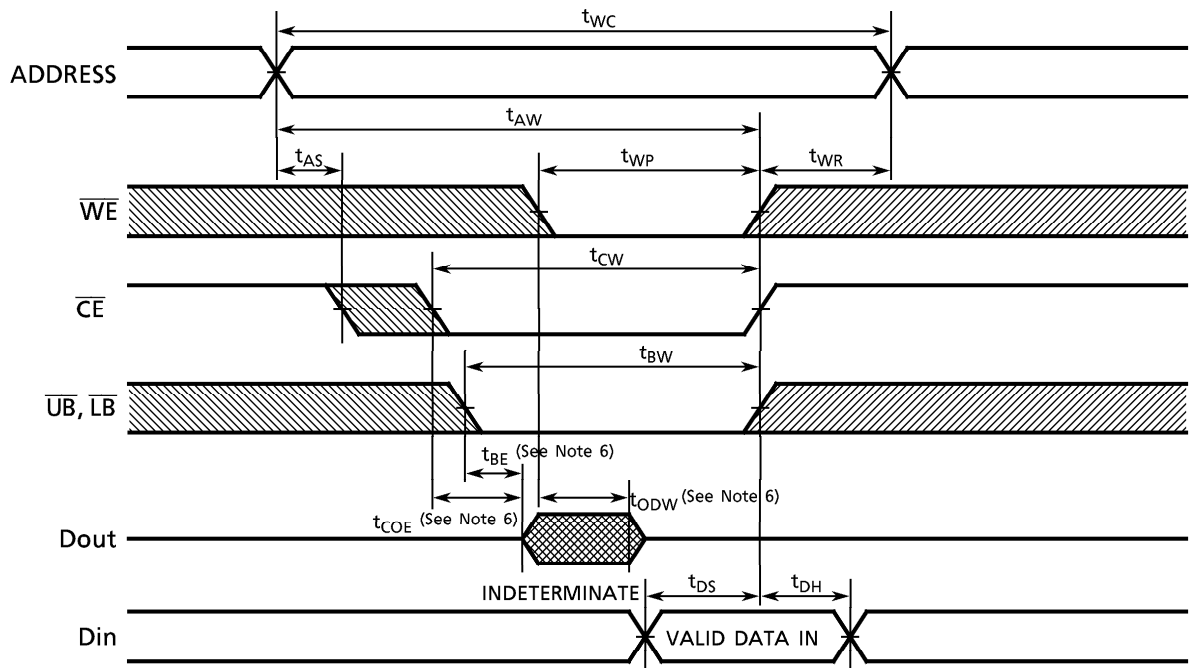

WRITE CYCLE 3 ($\overline{UB}, \overline{LB}$ CONTROLLED) (See Note 5)

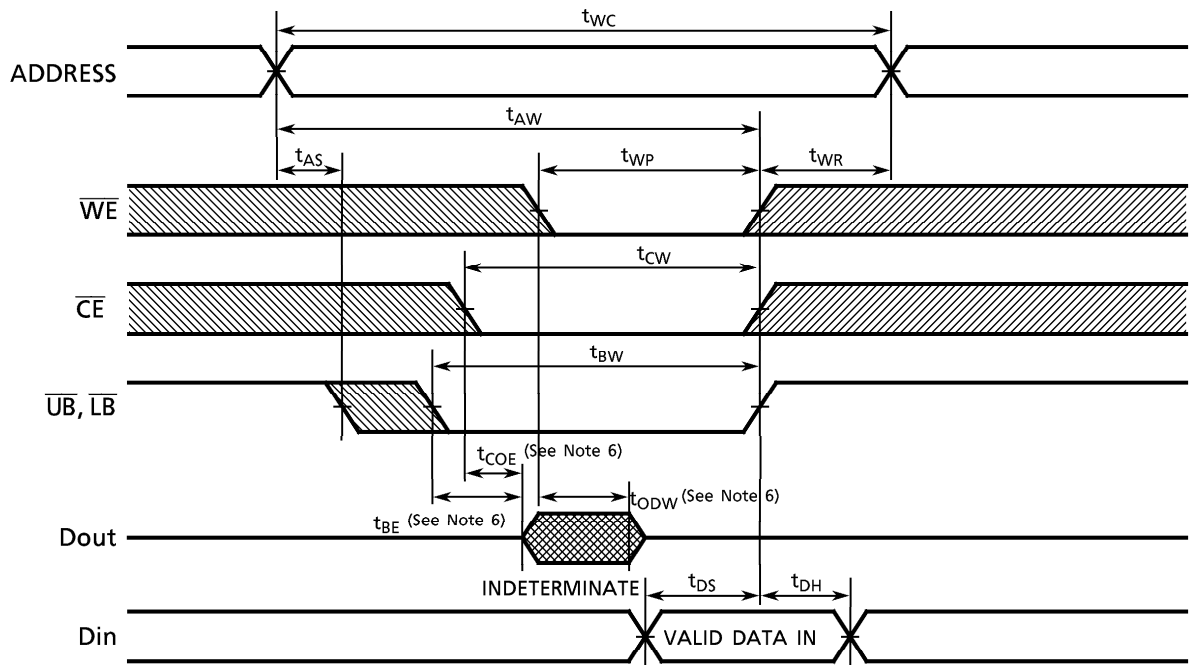

Note: (1) Operating temperature (T_a) is guaranteed for transverse air flow exceeding 400 linear feet per minute.

(2) \overline{WE} remains HIGH for the Read Cycle.

(3) If \overline{CE} goes LOW coincident with or after \overline{WE} goes LOW, the outputs will remain at high impedance.

(4) If \overline{CE} goes HIGH coincident with or before \overline{WE} goes HIGH, the outputs will remain at high impedance.

(5) If \overline{OE} is HIGH during the write cycle, the outputs will remain at high impedance.

(6) The parameters specified below are measured using the load shown in Fig. 1.

(A) $t_{COE}, t_{OEE}, t_{BE}, t_{OEw}$ Output Enable Time

(B) $t_{COD}, t_{ODO}, t_{BD}, t_{ODW}$ Output Disable Time

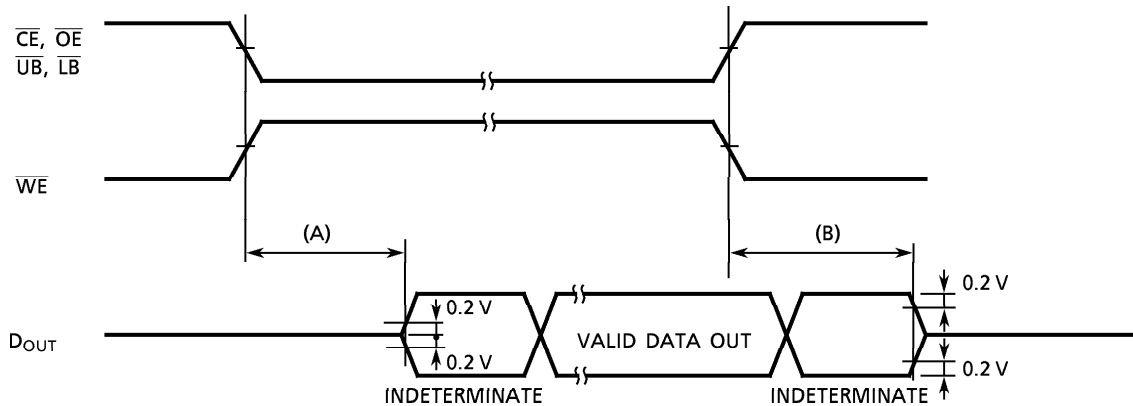

PACKAGE DIMENSIONS

Plastic TSOP (TSOPII 54-P-400-0.80B)

Unit in mm

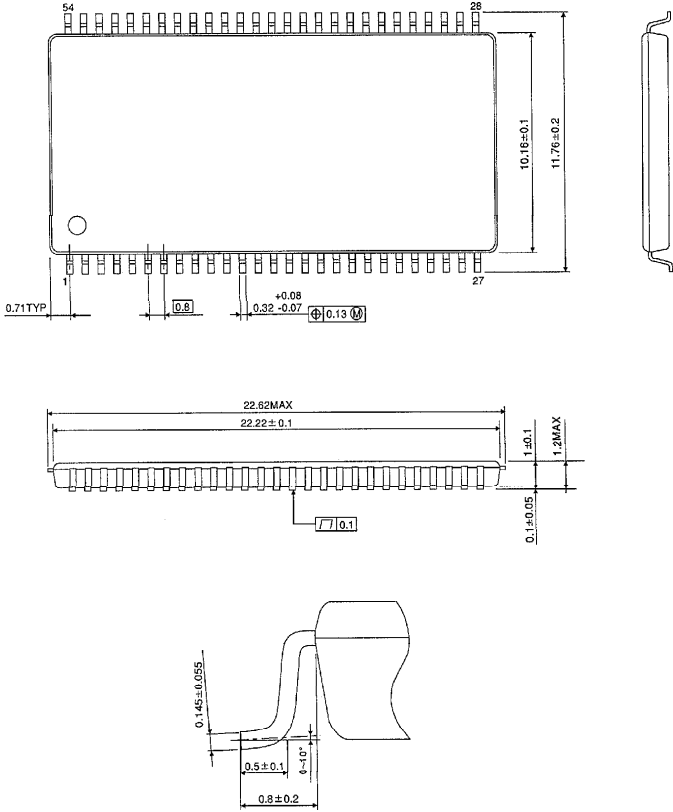

Weight : 0.55g (Typ)