

C-13-DFB2.5-XX-SXXXX/XXX-X-XX

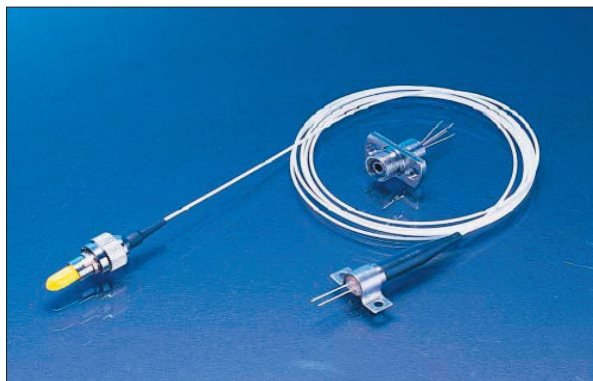

Features

- Un-cooled laser diode with MQW structure
- High temperature operation without active cooling
- Hermetically sealed active component
- Built-in InGaAs monitor photodiode
- Complies with Telcordia Technologies GR-468-CORE
- Single frequency operation with high SMSR

Packaging

- TOSA
- FC/ST/SC receptacle package with 2-hole flange
- Fiber pigtailed with optional FC/ST/SC/MU/LC connector

Application

- Design for 2.5Gbps high speed optics networks
- RoHS Compliant available

Absolute Maximum Ratings (Tc=25°C)

| Parameter | Symbol | Rating | Unit |
|----------------------------|-----------|-------------------------------|------|
| Fiber Output Power L/M/H/2 | P_f | 1(L) / 1.5(M) / 2.5(H) / 3(2) | mW |
| LD Reverse Voltage | V_{RLD} | 2 | V |
| PD Reverse Voltage | V_{RPD} | 10 | V |
| PD Forward Current | I_{FPD} | 2.0 | mA |
| Operating Temperature | T_{opr} | 0 ~+70 | °C |
| Storage Temperature | T_{stg} | -40 ~+85 | °C |

(All optical data refer to a coupled 9/125µm SM fiber)

Optical and Electrical Characteristics (Tc=25°C)

| Parameter | Symbol | Min | Typ | Max | Unit | Test Conditions |
|-----------------------------|--------------------|------|------|------|------|---|
| Threshold Current | I_{th} | - | 10 | 15 | mA | CW |
| Fiber Output Power | L | 0.2 | - | 0.5 | mW | CW, $I_{th}+20mA$, kink free |
| | M | 0.5 | - | 1 | | |
| | H | 1 | 1.6 | - | | |
| | 2 | 2 | 2.5 | - | | |
| Peak Wavelength | λ | 1295 | 1310 | 1325 | nm | Note 3 |
| Side mode Suppression Ratio | Sr | 30 | 35 | - | dB | CW, $P_f = P_f$ (Min), 0~70°C |
| Forward Voltage | V_f | - | 1.2 | 1.5 | V | CW, $P_f = P_f$ (Min) |
| Rise/Fall Time | t_r / t_f | - | - | 150 | ps | $I_{bias} = I_{th}$, 20~80% Lead length=1mm |
| Tracking Error | $\Delta P_f / P_f$ | -1.5 | - | 1.5 | dB | APC, 0~70°C |
| PD Monitor Current | I_m | 100 | - | - | µA | CW, $P_f = P_f$ (Min), $V_{RPD} = 2V$ |
| PD Dark Current | I_{DARK} | - | - | 0.1 | µA | $V_{RPD} = 5V$ |
| PD Capacitance | C_t | - | 6 | 15 | pF | $V_{RPD} = 5V, f = 1MHz$ |

Note: 1.Pin assignment can be customized.

2.Specifications subject to change without notice.

3.Selected wavelength is available for WDM application.

C-13-DFB2.5-XX-SXXXX/XXX-X-XX

LD Pin Assignment

Part Number: C-13-DFB2.5-RX-SXXXX-XX

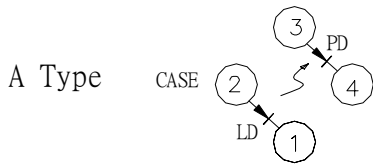

- Pin 1 : Laser Cathode
- Pin 2 : Laser Anode and Case Gnd
- Pin 3 : Monitor Diode Anode
- Pin 4 : Monitor Diode Cathode

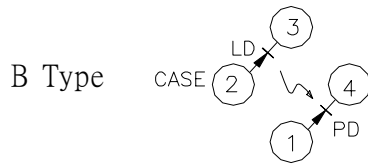

- Pin 1 : Monitor Diode Anode
- Pin 2 : Laser Anode and Case Gnd
- Pin 3 : Laser Cathode
- Pin 4 : Monitor Diode Cathode



- Pin 1 : Laser Anode and Monitor Diode Cathode
- Pin 2 : Case Gnd
- Pin 3 : Laser Cathode
- Pin 4 : Monitor Diode Anode

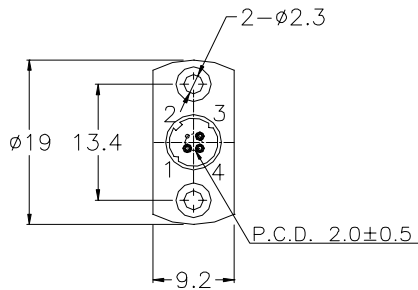

FC Receptacle

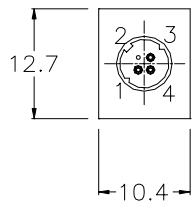
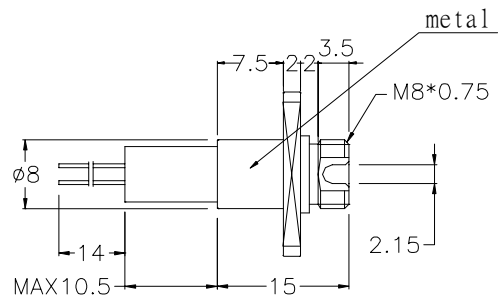

ST Receptacle

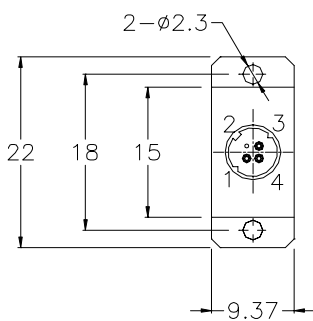
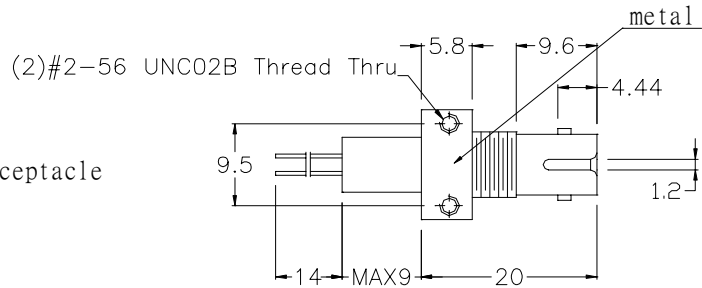

SC Receptacle

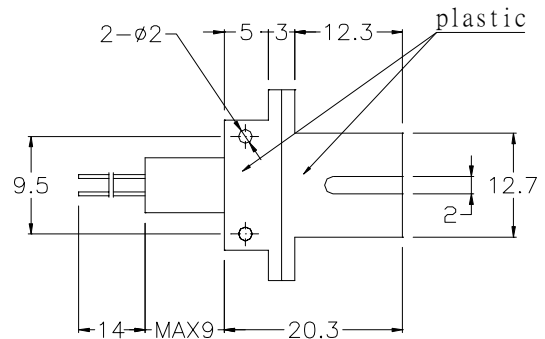

C-13-DFB2.5-XX-SXXXX/XXX-X-XX

Packaging Dimension

Units in mm.

Part Number: C-13-DFB2.5-TX-SSCXX-XX

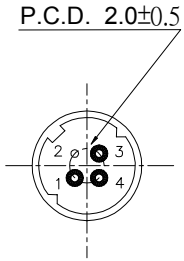

SC TOSA (L&M Power)
C-13-DFB2.5-TX-SSCXX-XX

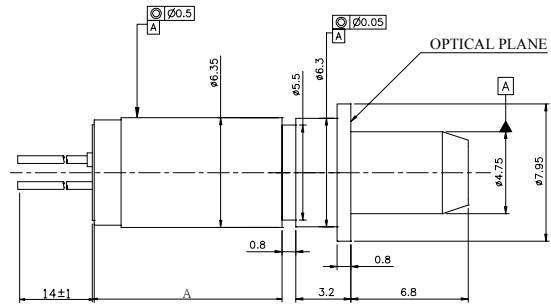

DIMENSION A: 7.77~8.37mm

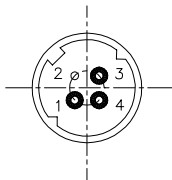

SC TOSA
(L&M Power with Isolator)
C-13-DFB2.5-TX-SSCXI-XX

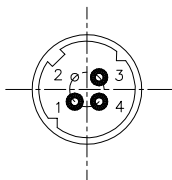
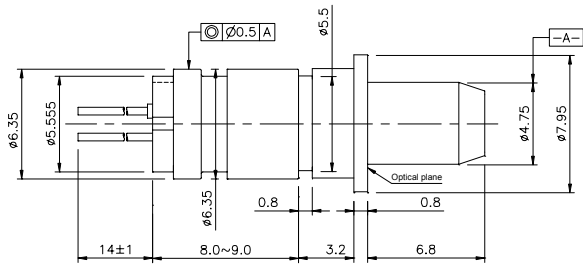

SC TOSA (H&2 Power)
C-13-DFB2.5-TX-SSCXX-XX

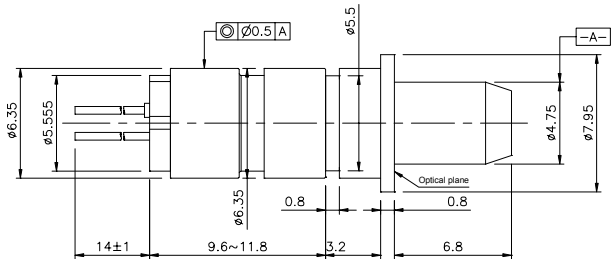

Packaging Dimension

Units in mm.

Part Number: C-13-DFB2.5-TX-SLCXX-XX

P.C.D. 2.0 ± 0.5

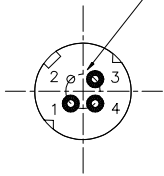

LC TOSA (L&M Power)
C-13-DFB2.5-TX-SLCX-XX

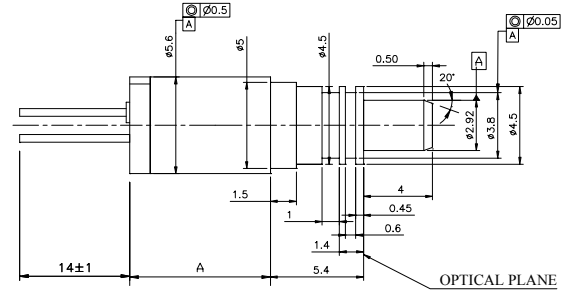

DIMENSION A: 7.77~8.37mm

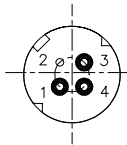

LC TOSA
(L&M Power with Isolator)
C-13-DFB2.5-TX-SLCXI-XX

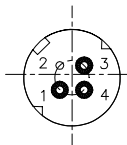
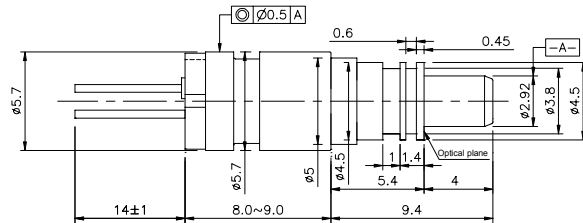

LC TOSA (H&2 Power)
C-13-DFB2.5-TX-SLCXX-XX

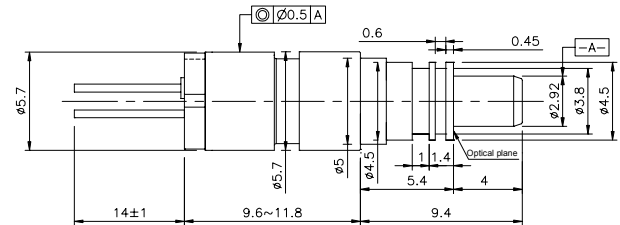

Packaging Dimension

Units in mm.

Part Number: C-15-DFB2.5-PX-SXXXX/XXX-X-XX

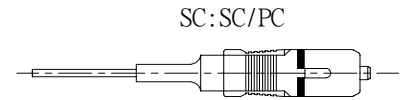
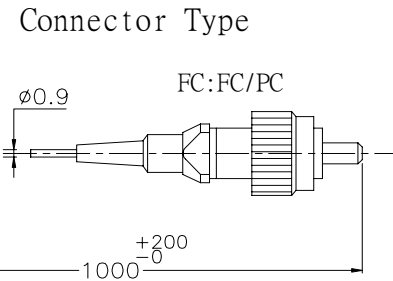
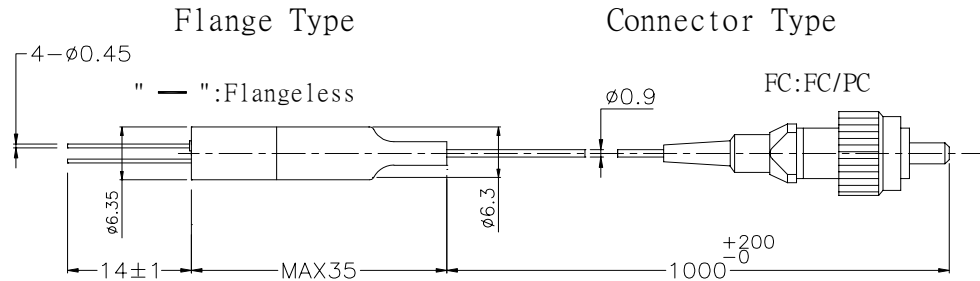
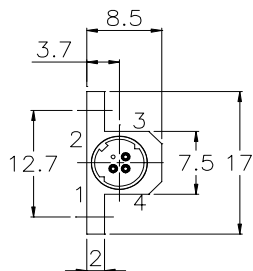
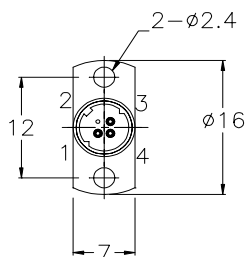
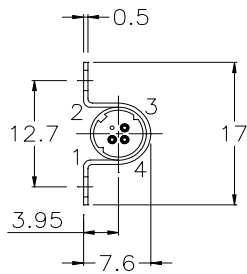
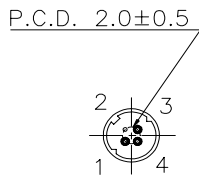

"O": Horizontal (Omega Housing)

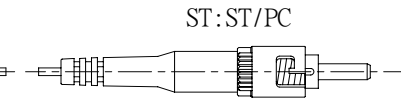
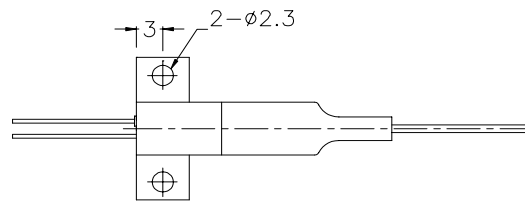

MU:MUJ / PC



"V": Vertical

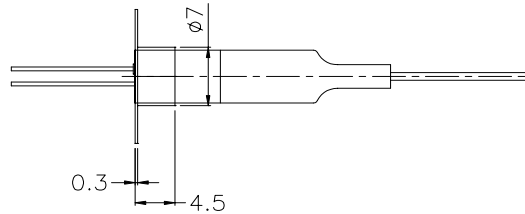

LC:LC/PC

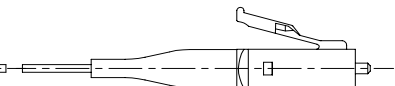

"K": Horizontal (KX Housing)

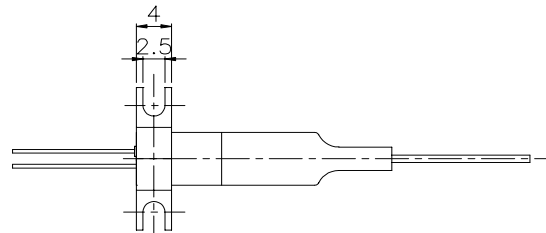

Ordering Information

C-13-DFB2.5-XX-SXXXXX/XXX-X-XX

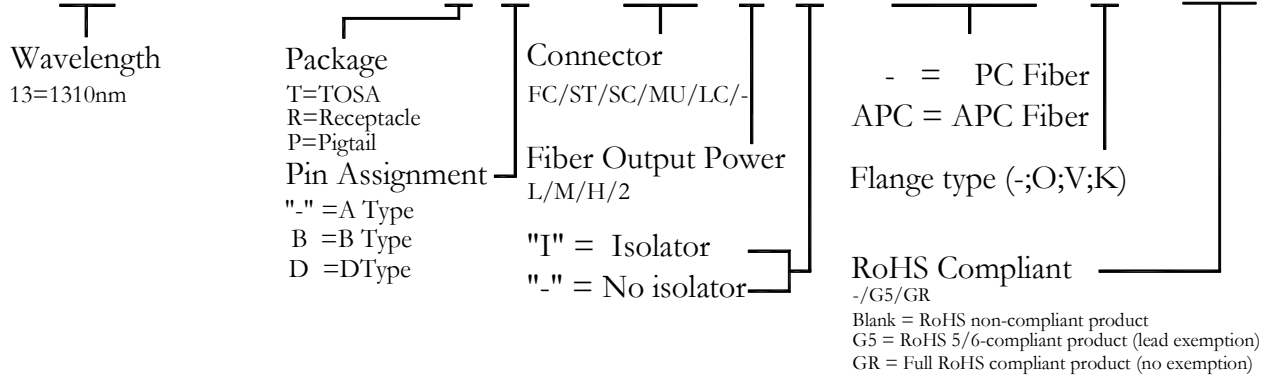

Warnings

Handling Precautions: This device is susceptible to damage as a result of electrostatic discharge (ESD). A static free environment is highly recommended. Follow guidelines according to proper ESD procedures.

Laser Safety: Radiation emitted by laser devices can be dangerous to human eyes. Avoid eye exposure to direct or indirect radiation.

Legal Notice

IMPORTANT NOTICE!

All information contained in this document is subject to change without notice, at LuminentOIC's sole and absolute discretion. LuminentOIC warrants performance of its products to current specifications only in accordance with the company's standard one-year warranty; however, specifications designated as "preliminary" are given to describe components only, and LuminentOIC expressly disclaims any and all warranties for said products, including express, implied, and statutory warranties, warranties of merchantability, fitness for a particular purpose, and non-infringement of proprietary rights. Please refer to the company's Terms and Conditions of Sale for further warranty information.

LuminentOIC assumes no liability for applications assistance, customer product design, software performance, or infringement of patents, services, or intellectual property described herein. No license, either express or implied, is granted under any patent right, copyright, or intellectual property right, and LuminentOIC makes no representations or warranties that the product(s) described herein are free from patent, copyright, or intellectual property rights. Products described in this document are NOT intended for use in implantation or other life support applications where malfunction may result in injury or death to persons. LuminentOIC customers using or selling products for use in such applications do so at their own risk and agree to fully defend and indemnify LuminentOIC for any damages resulting from such use or sale.

THE INFORMATION CONTAINED IN THIS DOCUMENT IS PROVIDED ON AN "AS IS" BASIS. Customer agrees that LuminentOIC is not liable for any actual, consequential, exemplary, or other damages arising directly or indirectly from any use of the information contained in this document. Customer must contact LuminentOIC to obtain the latest version of this publication to verify, before placing any order, that the information contained herein is current.

© LuminentOIC, Inc. 2005
All rights reserved