

ABSOLUTE MAXIMUM RATINGS⁽¹⁾

V_{CC} to V_{SS}	-0.3V to +34V
V_{CC} to AGND	-0.3V to +17V
V_{SS} to AGND	-17V to +0.3V
AGND to DGND	-0.3V to +0.3V
REF_{IN} to AGND	-9V to +11V
V_{DD} to DGND	0V to $V_{CC} - 1.4V$
Digital Input Voltage to DGND	-0.3V to $V_{DD} + 0.3V$
Digital Output Voltage to DGND	-0.3V to $V_{DD} + 0.3V$
Operating Temperature Range	-40°C to +85°C
Storage Temperature Range	-65°C to +150°C
Junction Temperature	+150°C

NOTE: (1) Stresses above those listed under "Absolute Maximum Ratings" may cause permanent damage to the device. Exposure to absolute maximum conditions for extended periods may affect device reliability.



ELECTROSTATIC DISCHARGE SENSITIVITY

This integrated circuit can be damaged by ESD. Texas Instruments recommends that all integrated circuits be handled with appropriate precautions. Failure to observe proper handling and installation procedures can cause damage.

ESD damage can range from subtle performance degradation to complete device failure. Precision integrated circuits may be more susceptible to damage because very small parametric changes could cause the device not to meet its published specifications.

PACKAGE/ORDERING INFORMATION

PRODUCT	LINEARITY ERROR (LSB)	DIFFERENTIAL NONLINEARITY (LSB)	PACKAGE-LEAD	PACKAGE DESIGNATOR ⁽¹⁾	SPECIFIED TEMPERATURE RANGE	ORDERING NUMBER	PACKAGE MARKING	TRANSPORT MEDIA, QUANTITY
DAC7741Y "	±6 "	±4 "	LQFP-48 "	PT "	-40°C to +85°C "	DAC7741Y/250 DAC7741Y/2K	DAC7741Y "	Tape and Reel, 250 Tape and Reel, 2000
DAC7741YB "	±4 "	±2 "	LQFP-48 "	PT "	-40°C to +85°C "	DAC7741YB/250 DAC7741YB/2K	DAC7741YB "	Tape and Reel, 250 Tape and Reel, 2000
DAC7741YC "	±3 "	±1 "	LQFP-48 "	PT "	-40°C to +85°C "	DAC7741YC/250 DAC7741YC/2K	DAC7741YC "	Tape and Reel, 250 Tape and Reel, 2000
DAC7741YL "	±2 "	±1 "	LQFP-48 "	PT "	0°C to +70°C "	DAC7741YL/250 DAC7741YL/2K	DAC7741YL "	Tape and Reel, 250 Tape and Reel, 2000

NOTE: (1) For the most current specifications and package information, refer to our web site at www.ti.com.

ELECTRICAL CHARACTERISTICS

All specifications at $T_A = T_{MIN}$ to T_{MAX} , $V_{CC} = +15V$, $V_{SS} = -15V$, $V_{DD} = +5V$, internal reference enabled, unless otherwise noted.

PARAMETER	CONDITIONS	DAC7741Y			DAC7741YB			UNITS
		MIN	TYP	MAX	MIN	TYP	MAX	
ACCURACY Linearity Error (INL)	$T_A = 25^\circ C$			±6			±4	LSB
Differential Linearity Error (DNL)				±5			±3	LSB
Monotonicity		14		±4	15		±2	LSB
Offset Error				±0.1			*	Bits
Offset Error Drift				±2			*	% of FSR ppm/°C
Gain Error		With Internal REF With External REF			±0.4 ±0.25			±0.25 ±0.1
Gain Error Drift	With Internal REF		±15			±10		ppm/°C
PSRR (V_{CC} or V_{SS})	At Full-Scale		50	200		*	*	ppm/V
ANALOG OUTPUT⁽¹⁾ Voltage Output ⁽²⁾	AGND		+11.4/-4.75 ⁽¹⁾ +11.4/-11.4 ⁽¹⁾ +11.4/-6.4 ⁽¹⁾	0 to 10 ±10 ±5				V V V
Output Current		±5		*				mA
Output Impedance			0.1		*			Ω
Maximum Load Capacitance			200		*			pF
Short-Circuit Current			±15		*			mA
Short-Circuit Duration			Indefinite		*			
REFERENCE Reference Output		Absolute Max Value that can be applied is V_{CC}	9.96	10	10.04	9.975	*	10.025
REF_{OUT} Impedance			400			*		Ω
REF_{OUT} Voltage Drift			±15			±10		ppm/°C
REF_{OUT} Voltage Adjustment ⁽³⁾	±25				*			mV
REF_{IN} Input Range ⁽⁴⁾	4.75			$V_{CC} - 1.4$	*		*	V
REF_{IN} Input Current			10		*		*	nA
REFADJ Input Range	0			10	*		*	V
REFADJ Input Impedance			50		*		*	kΩ
V_{REF} Output Current	-2			+2	*		*	mA
V_{REF} Impedance			1		*		*	Ω

ELECTRICAL CHARACTERISTICS (Cont.)

All specifications at $T_A = T_{MIN}$ to T_{MAX} , $V_{CC} = +15V$, $V_{SS} = -15V$, $V_{DD} = +5V$, internal reference enabled, unless otherwise noted.

PARAMETER	CONDITIONS	DAC7741Y			DAC7741YB			UNITS
		MIN	TYP	MAX	MIN	TYP	MAX	
DYNAMIC PERFORMANCE Settling Time to $\pm 0.003\%$	20V Output Step $R_L = 5k\Omega$, $C_L = 200pF$, with external REF_{OUT} to REF_{IN} filter ⁽⁵⁾		3	5		*	*	μs
Digital Feedthrough Output Noise Voltage	at 10kHz		2 100			*	*	$\frac{nV \cdot s}{nV/\sqrt{Hz}}$
DIGITAL INPUT V_{IH} V_{IL}	$ I_{IH} < 10\mu A$ $ I_{IL} < 10\mu A$	$0.7 \cdot V_{DD}$		$0.3 \cdot V_{DD}$	*		*	V V
DIGITAL OUTPUT V_{OH} V_{OL}	$I_{OH} = -0.8mA$ $I_{OL} = 1.6mA$	3.6		0.4	*		*	V V
POWER SUPPLY V_{DD} V_{CC} V_{SS} I_{DD} I_{CC} I_{SS} Power	Bipolar Operation Unipolar Operation Unloaded Unloaded No Load, Ext. Reference No Load, Int. Reference	+4.75 +11.4 -15.75 -15.75	+5.0 100 4 85 -4 100	+5.25 +15.75 -11.4 -4.75 6 150	* * * * * * * *	* * * * * *	* * * * * * * *	V V V V μA mA mA mW mW
TEMPERATURE RANGE Specified Performance		-40		+85	*		*	$^{\circ}C$

* Specifications same as grade to the left.

NOTES: (1) With minimum V_{CC}/V_{SS} requirements, internal reference enabled.

(2) Please refer to the "Theory of Operation" section for more information with respect to output voltage configurations.

(3) See Figure 7 for gain and offset adjustment connection diagrams when using the internal reference.

(4) The minimum value for REF_{IN} must be equal to the greater of $V_{SS} + 14V$ and $+4.75V$, where $+4.75V$ is the minimum voltage allowed.

(5) Reference low-pass filter values: $100k\Omega$, $1.0\mu F$ (See Figure 10).

ELECTRICAL CHARACTERISTICS

All specifications at $T_A = T_{MIN}$ to T_{MAX} , $V_{CC} = +15V$, $V_{SS} = -15V$, $V_{DD} = +5V$, internal reference enabled, unless otherwise noted.

PARAMETER	CONDITIONS	DAC7741YL			DAC7741YC			UNITS
		MIN	TYP	MAX	MIN	TYP	MAX	
ACCURACY								
Linearity Error (INL)	$T_A = 25^\circ C$		± 1	± 2			± 3	LSB
Differential Linearity Error (DNL)				± 1			± 2	LSB
Monotonicity		16			16		± 1	LSB
Offset Error				± 0.1			*	Bits
Offset Error Drift			± 2			*	*	% of FSR
Gain Error	With Internal REF			± 0.4			± 0.2	ppm/ $^\circ C$
Gain Error Drift	With External REF			± 0.25			± 0.1	% of FSR
PSRR (V_{CC} or V_{SS})	With Internal REF At Full-Scale		± 15 50	200		± 7 *	*	ppm/ $^\circ C$ ppm/V
ANALOG OUTPUT⁽¹⁾								
Voltage Output ⁽²⁾	$+11.4/-4.75^{(1)}$ $+11.4/-11.4^{(1)}$ $+11.4/-6.4^{(1)}$		0 to 10 ± 10 ± 5			*	*	V
Output Current		± 5			*			V
Output Impedance			0.1			*		V
Maximum Load Capacitance			200			*		mA
Short-Circuit Current			± 15			*		Ω
Short-Circuit Duration	AGND		Indefinite			*		pF
								mA
REFERENCE								
Reference Output		9.96	10	10.04	9.975	*	10.025	V
REF _{OUT} Impedance			400			*		Ω
REF _{OUT} Voltage Drift			± 15			± 7		ppm/ $^\circ C$
REF _{OUT} Voltage Adjustment ⁽³⁾		± 25			*			mV
REF _{IN} Input Range ⁽⁴⁾		4.75		$V_{CC} - 1.4$	*		*	V
REF _{IN} Input Current			10			*		nA
REFADJ Input Range	Absolute Max Value that can be applied is V_{CC}	0		10	*		*	V
REFADJ Input Impedance			50			*		k Ω
V_{REF} Output Current		-2		+2	*		*	mA
V_{REF} Impedance			1			*		Ω
DYNAMIC PERFORMANCE								
Settling Time to $\pm 0.003\%$	20V Output Step $R_L = 5k\Omega$, $C_L = 200pF$, with external REF _{OUT} to REF _{IN} filter ⁽⁵⁾		3	5		*	*	μs
Digital Feedthrough			2			*		nV-s
Output Noise Voltage	at 10kHz		100			*		nV/ \sqrt{Hz}
DIGITAL INPUT								
V_{IH}	$ I_H < 10\mu A$	$0.7 \cdot V_{DD}$			*			V
V_{IL}	$ I_L < 10\mu A$			$0.3 \cdot V_{DD}$			*	V
DIGITAL OUTPUT								
V_{OH}	$I_{OH} = -0.8mA$	3.6			*			V
V_{OL}	$I_{OL} = 1.6mA$			0.4			*	V
POWER SUPPLY								
V_{DD}		+4.00	+5.0	+5.25	+4.75	*	*	V
V_{CC}		+11.4		+15.75	*	*	*	V
V_{SS}	Bipolar Operation	-15.75		-11.4	*	*	*	V
	Unipolar Operation	-15.75		-4.75	*	*	*	V
I_{DD}			100			*		μA
I_{CC}	Unloaded		4	6		*	*	mA
I_{SS}	Unloaded	-4	-2.5		*	*	*	mA
Power	No Load, Ext. Reference		85			*	*	mW
	No Load, Int. Reference		100	150		*	*	mW
TEMPERATURE RANGE								
Specified Performance		0		70	-40		+85	$^\circ C$

* Specifications same as grade to the left.

NOTES: (1) With minimum V_{CC}/V_{SS} requirements, internal reference enabled.

(2) Please refer to the "Theory of Operation" section for more information with respect to output voltage configurations.

(3) See Figure 7 for gain and offset adjustment connection diagrams when using the internal reference.

(4) The minimum value for REF_{IN} must be equal to the greater of $V_{SS} + 14V$ and $+4.75V$, where $+4.75V$ is the minimum voltage allowed.

(5) Reference low-pass filter values: 100k Ω , 1.0 μF (See Figure 10).

PIN CONFIGURATION

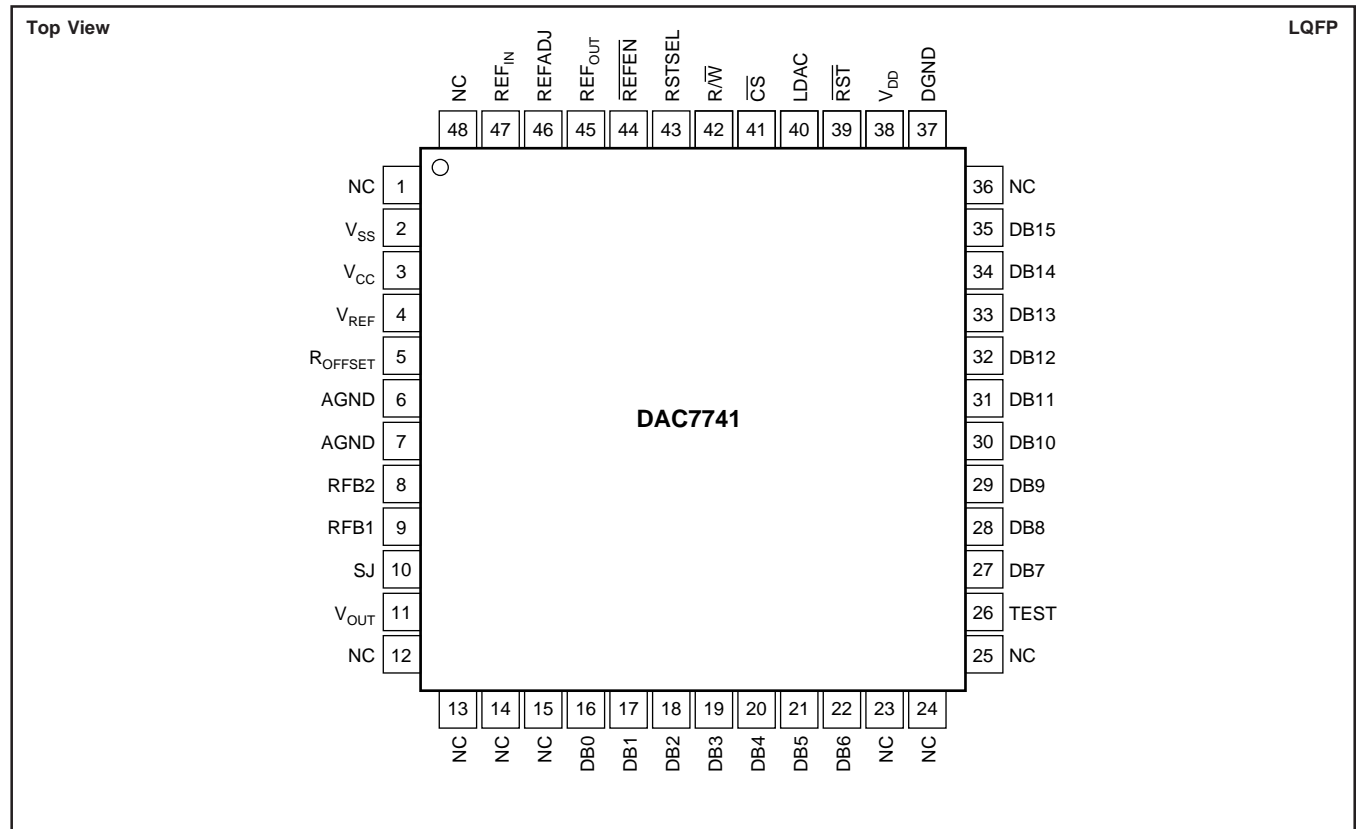

PIN DESCRIPTIONS

PIN	NAME	DESCRIPTION	PIN	NAME	DESCRIPTION
1	NC	No Connection	28	DB8	Data Bit 8
2	V _{SS}	Negative Analog Power Supply.	29	DB9	Data Bit 9
3	V _{CC}	Positive Analog Power Supply.	30	DB10	Data Bit 10
4	V _{REF}	Buffered Output from REF _{IN} , can be used to drive external devices. Internally, this pin directly drives the DAC circuitry.	31	DB11	Data Bit 11
5	R _{OFFSET}	Offsetting Resistor	32	DB12	Data Bit 12
6	AGND	Analog ground (Must be tied to analog ground)	33	DB13	Data Bit 13
7	AGND	Analog ground (Must be tied to analog ground)	34	DB14	Data Bit 14
8	RFB2	Feedback Resistor 2, used to configure DAC output range.	35	DB15	Data Bit 15 (MSB)
9	RFB1	Feedback Resistor 1, used to configure DAC output range.	36	NC	No Connection
10	SJ	Summing Junction of the Output Amplifier	37	DGND	Digital Ground
11	V _{OUT}	DAC Voltage Output	38	V _{DD}	Digital Power Supply
12	NC	No Connection	39	R _{ST}	V _{OUT} reset; active LOW, depending on the state of RSTSEL, the DAC register is either reset to mid-scale or min-scale.
13	NC	No Connection	40	LDAC	DAC register load control, rising edge triggered. Data is loaded from the input register to the DAC register.
14	NC	No Connection	41	CS	Chip Select, active LOW
15	NC	No Connection	42	R/W	Enabled by CS, controls data read (HIGH) and write (LOW) from or to the input register.
16	DB0	Data Bit 0 (LSB)	43	RSTSEL	Reset Select; determines the action of RST. If HIGH, RST will reset the DAC register to mid-scale. If LOW, RST will reset the DAC register to min-scale.
17	DB1	Data Bit 1	44	REFEN	Enables internal +10V reference (REF _{OUT}), active LOW.
18	DB2	Data Bit 2	45	REF _{OUT}	Internal Reference Output
19	DB3	Data Bit 3	46	REFADJ	Internal Reference Trim. (Acts as a gain adjustment input when the internal reference is used.)
20	DB4	Data Bit 4	47	REF _{IN}	Reference Input
21	DB5	Data Bit 5	48	NC	No Connection
22	DB6	Data Bit 6			
23	NC	No Connection			
24	NC	No Connection			
25	NC	No Connection			
26	TEST	Reserved, Connect to DGND			
27	DB7	Data Bit 7			

TIMING CHARACTERISTICS

PARAMETER	DESCRIPTION	DAC7741Y			UNITS
		MIN	TYP	MAX	
t_{RCS}	\overline{CS} LOW for Read	100			ns
t_{RDS}	R/ \overline{W} HIGH to \overline{CS} LOW	10			ns
t_{RDH}	R/ \overline{W} HIGH after \overline{CS} HIGH	10			ns
t_{DZ}	\overline{CS} HIGH to Data Bus High Impedance	10		70	ns
t_{CSD}	\overline{CS} LOW to Data Bus Valid		85	100	ns
t_{WCS}	\overline{CS} LOW for Write	30			ns
t_{WS}	R/ \overline{W} LOW to \overline{CS} LOW	10			ns
t_{WH}	R/ \overline{W} LOW after \overline{CS} HIGH	10			ns
t_{LS}	\overline{CS} LOW to LDAC HIGH	40			ns
t_{LH}	\overline{CS} LOW after LDAC HIGH	0			ns
t_{LX}	LDAC HIGH	30			ns
t_{DS}	Data Valid to \overline{CS} LOW	0			ns
t_{DH}	Data Valid after \overline{CS} HIGH	20			ns
t_{LWD}	LDAC LOW	40			ns
t_{SS}	RSTSEL Valid Before \overline{RST} LOW	0			ns
t_{SH}	RSTSEL Valid After \overline{RST} HIGH	10			ns
t_{RSS}	\overline{RST} LOW	30			ns
t_s	Voltage Output Settling Time			5	μ s

TIMING DIAGRAMS

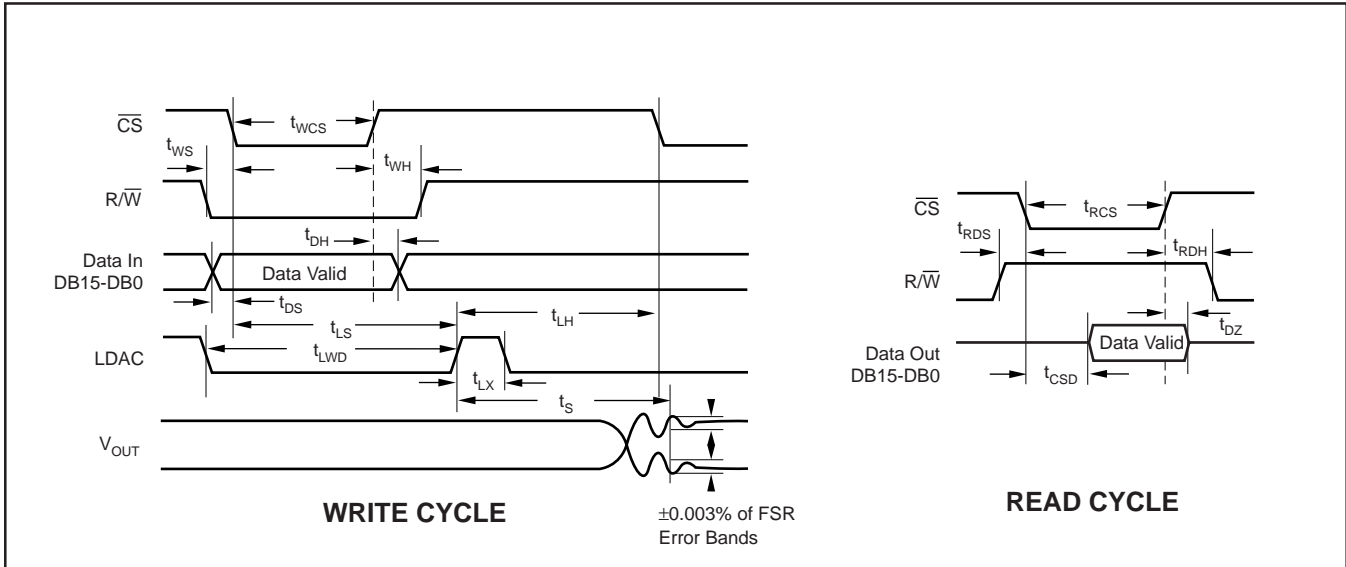

RESET TIMING

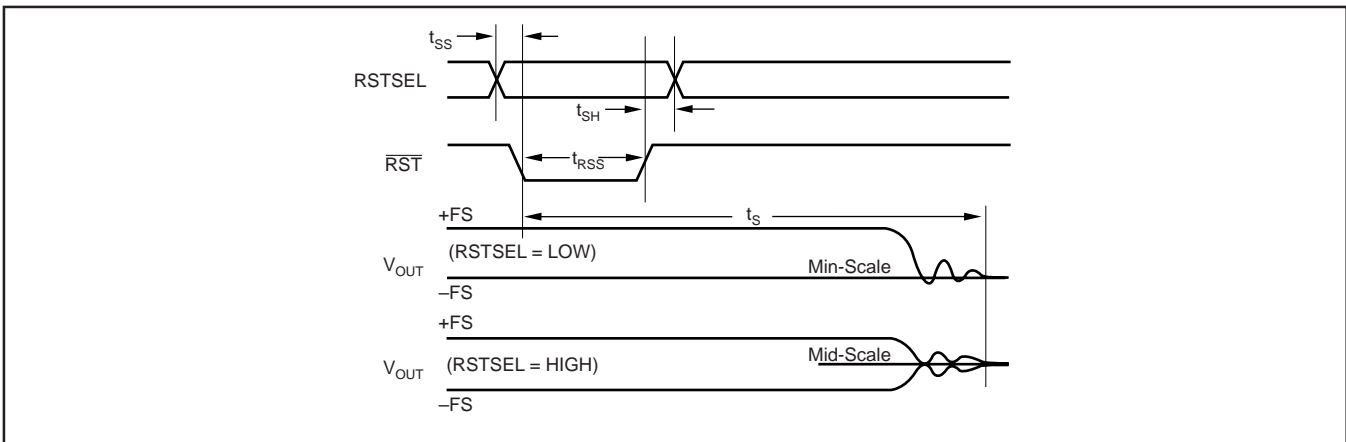

TYPICAL CHARACTERISTICS

$T_A = +25^\circ\text{C}$ (unless otherwise noted)

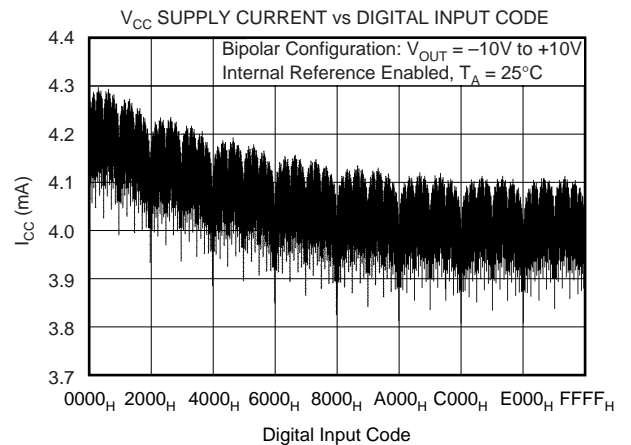
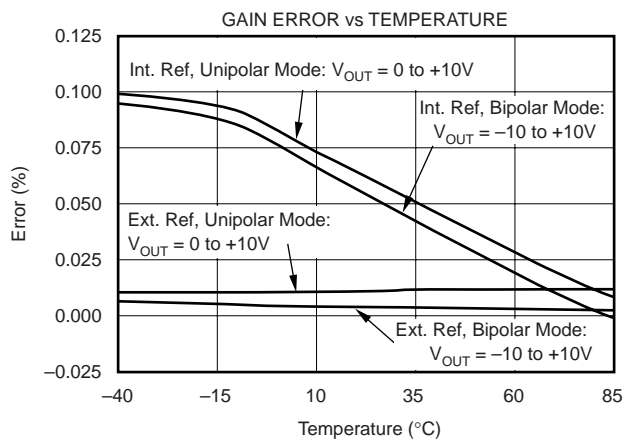
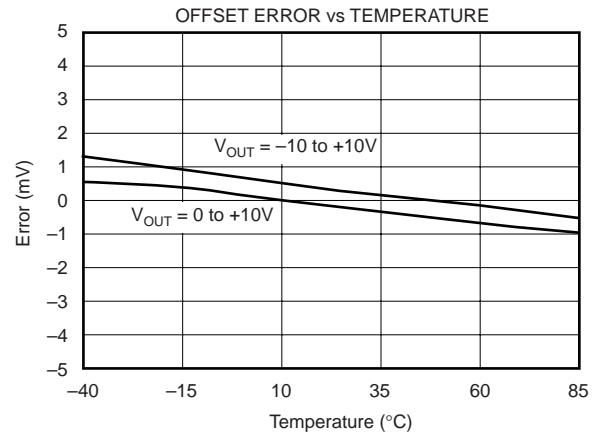
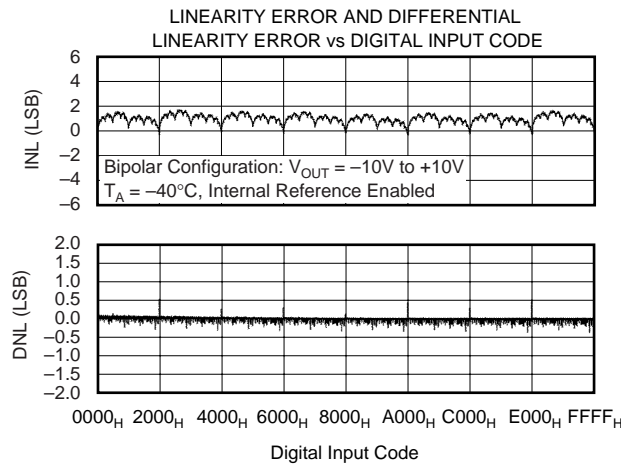
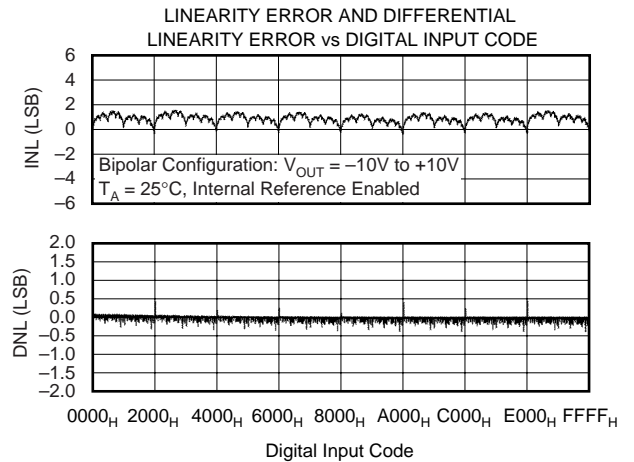
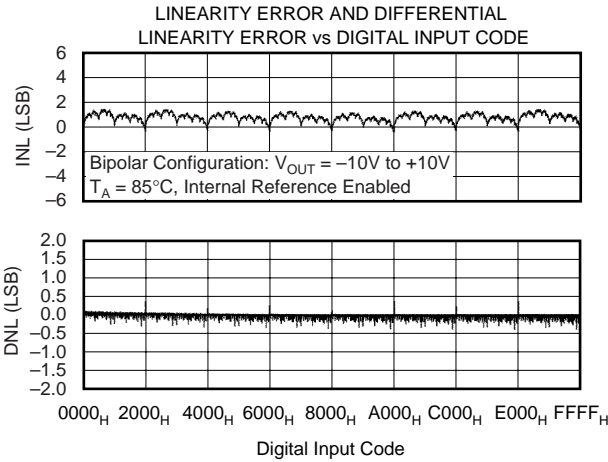

TYPICAL CHARACTERISTICS (Cont.)

$T_A = +25^\circ\text{C}$ (unless otherwise noted)

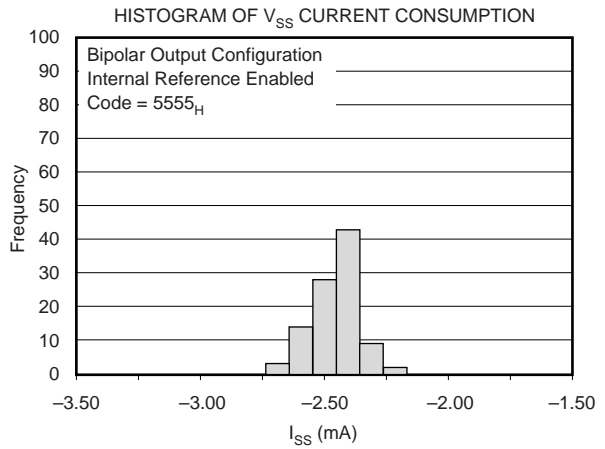
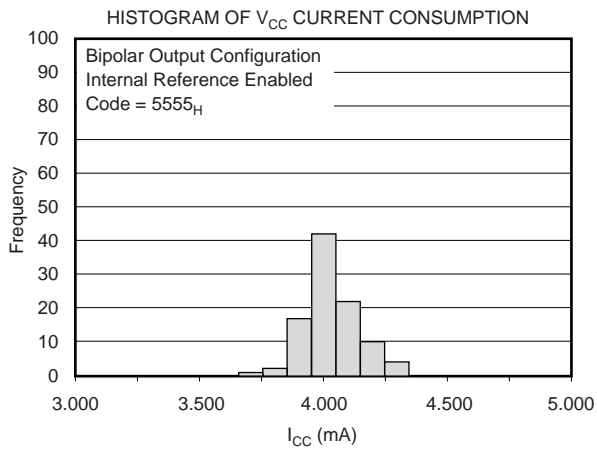
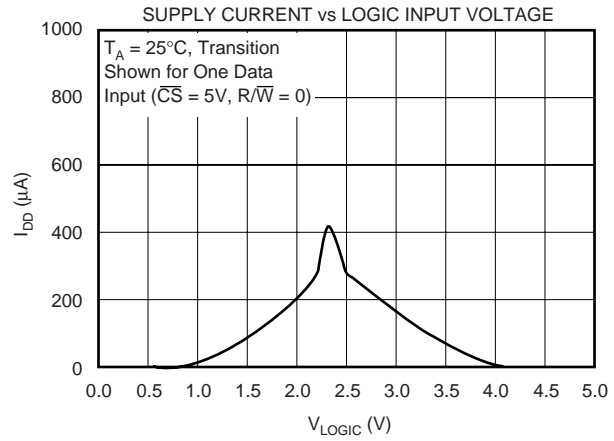
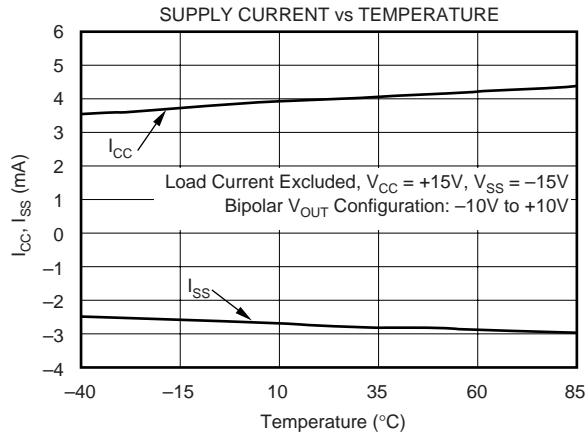
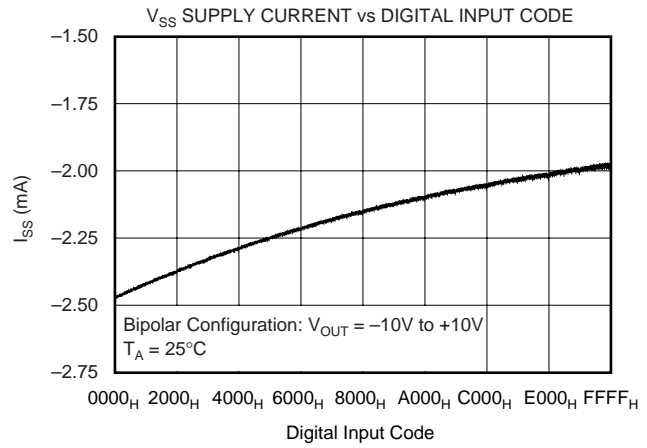
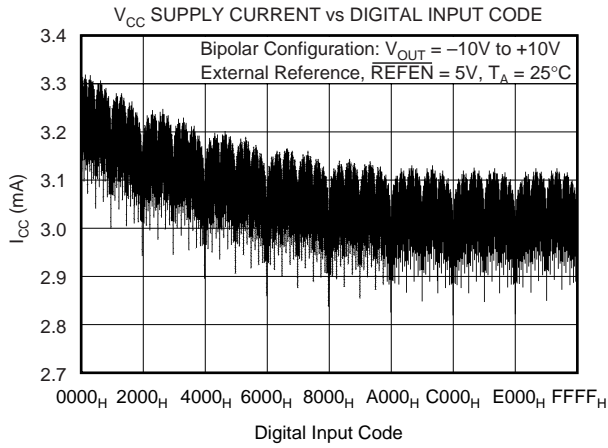

TYPICAL CHARACTERISTICS (Cont.)

T_A = +25°C (unless otherwise noted)

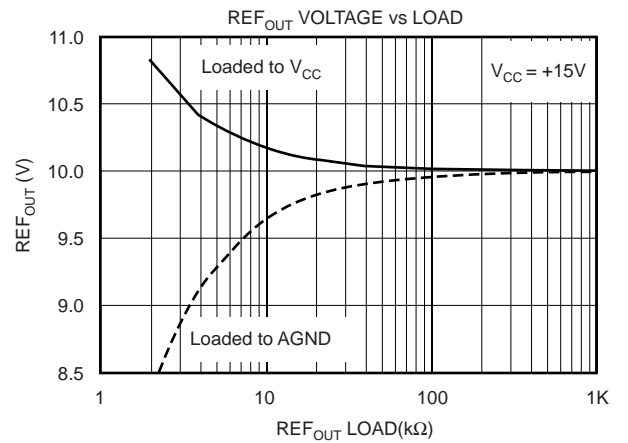
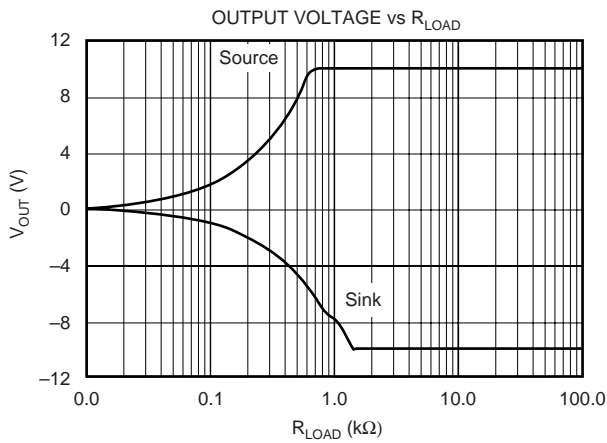
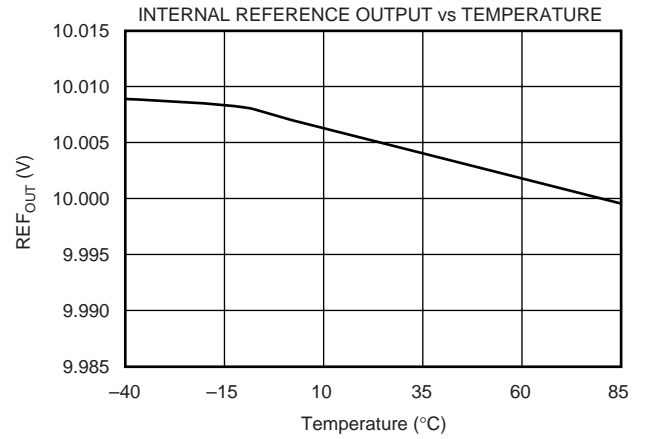
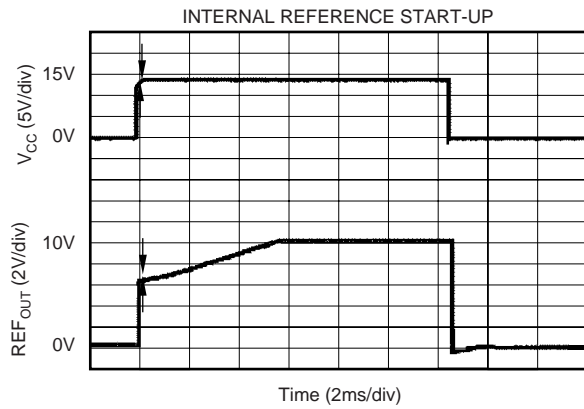
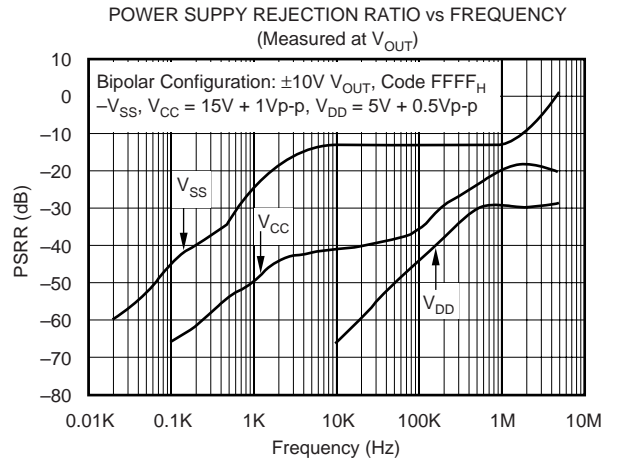
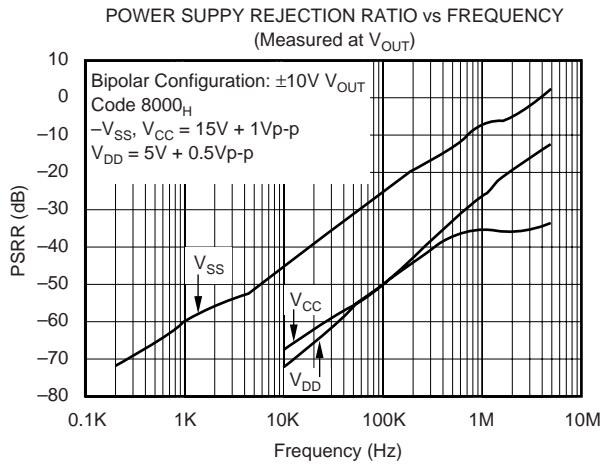

TYPICAL CHARACTERISTICS (Cont.)

T_A = +25°C (unless otherwise noted)

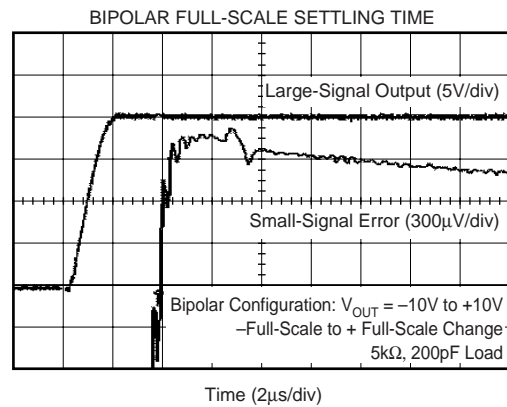
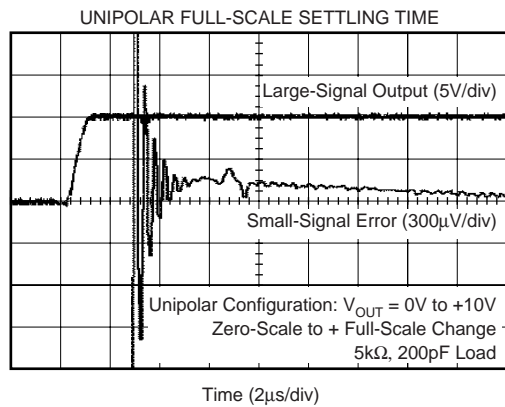
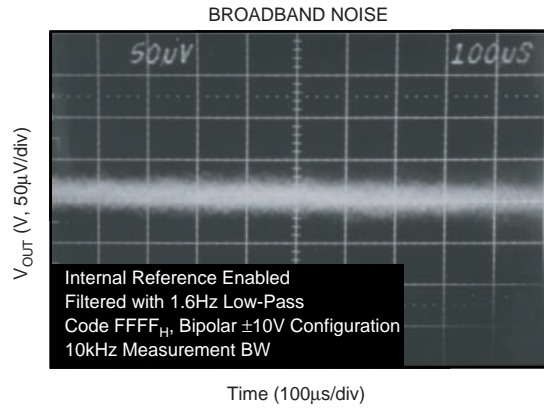
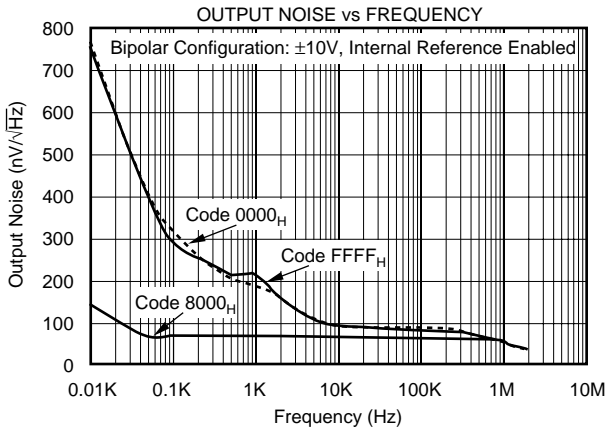
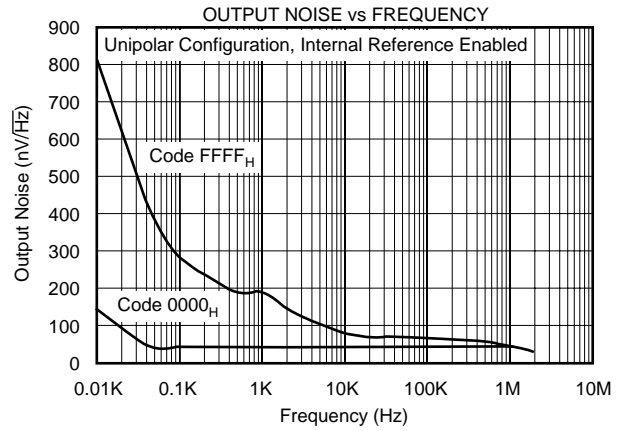
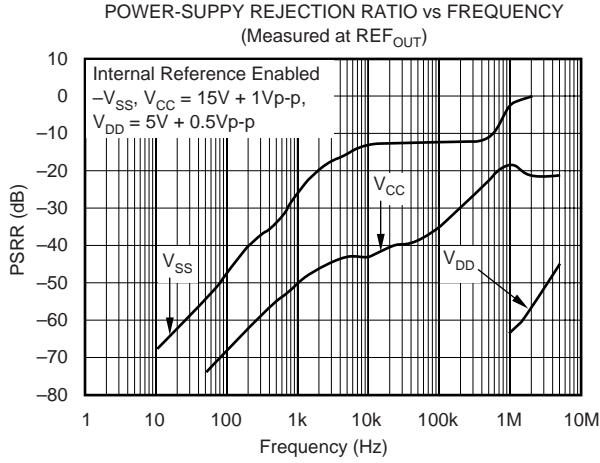

TYPICAL CHARACTERISTICS (Cont.)

$T_A = +25^\circ\text{C}$ (unless otherwise noted)

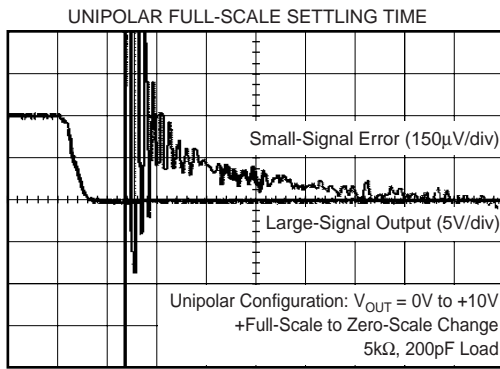

Time (2 $\mu\text{s}/\text{div}$)

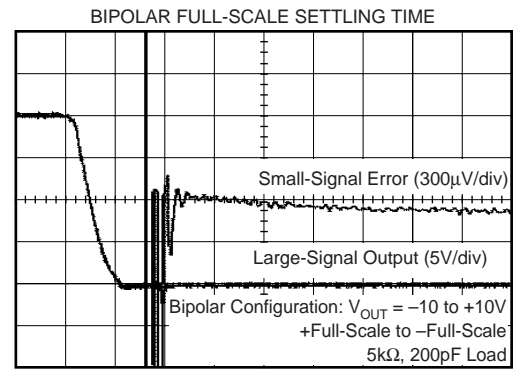

Time (2 $\mu\text{s}/\text{div}$)

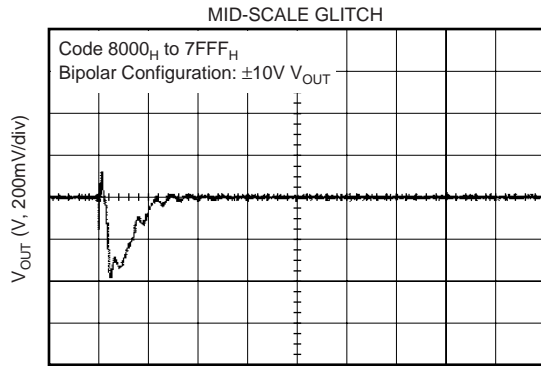

Time (1 $\mu\text{s}/\text{div}$)

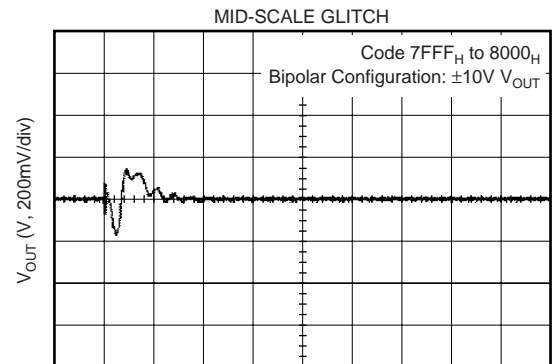

Time (1 $\mu\text{s}/\text{div}$)

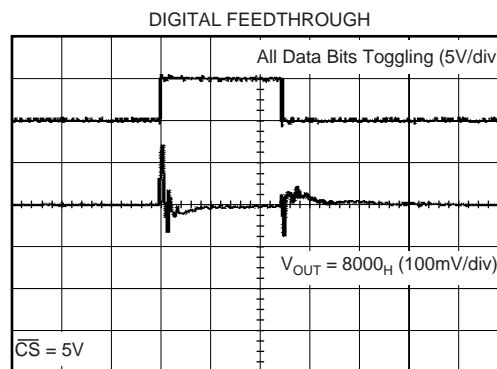

Time (200ns/div)

THEORY OF OPERATION

The DAC7741 is a voltage output, 16-bit DAC with a +10V built-in internal reference. The architecture is an R-2R ladder configuration with the three MSBs segmented, followed by an operational amplifier that serves as a buffer. The output buffer is designed to allow user-configurable output adjustments, giving the DAC7741 output voltage ranges of 0V to +10V, -5V to +5V, or -10V to +10V. Please refer to Figures 2, 3, and 4 for pin configuration information.

The digital input is a parallel word made up of the 16-bit DAC code, which is then loaded into the DAC register using the LDAC input pin. The converter can be powered from $\pm 12V$ to $\pm 15V$ dual analog supplies and a +5V logic supply. The device offers a reset function, which immediately sets the DAC output voltage and DAC register to min-scale (code 0000_H) or mid-scale (code 8000_H). The data I/O and reset functions are discussed in more detail in the following sections.

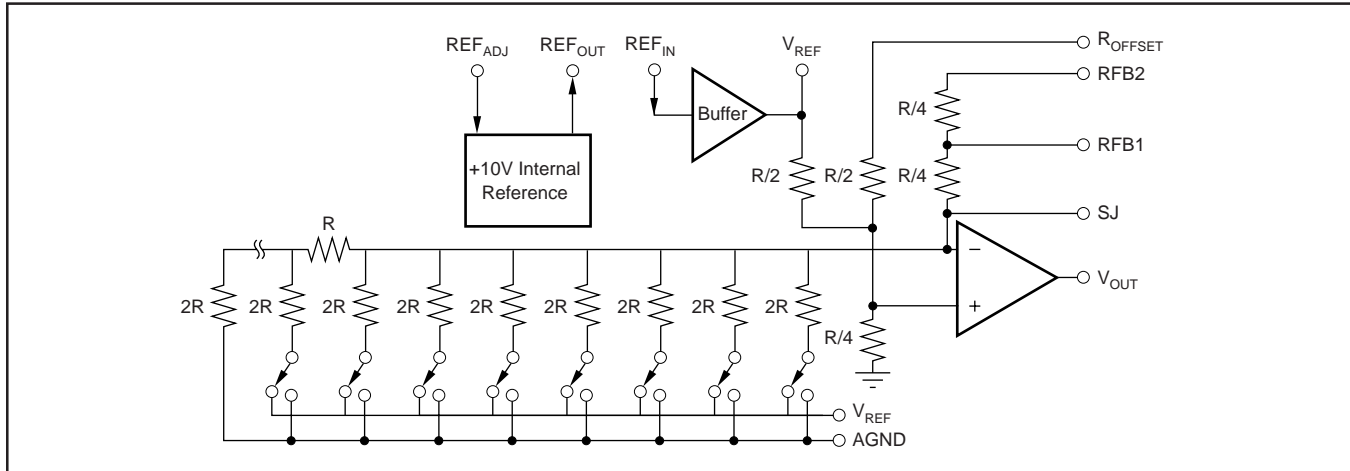

FIGURE 1. DAC7741 Architecture.

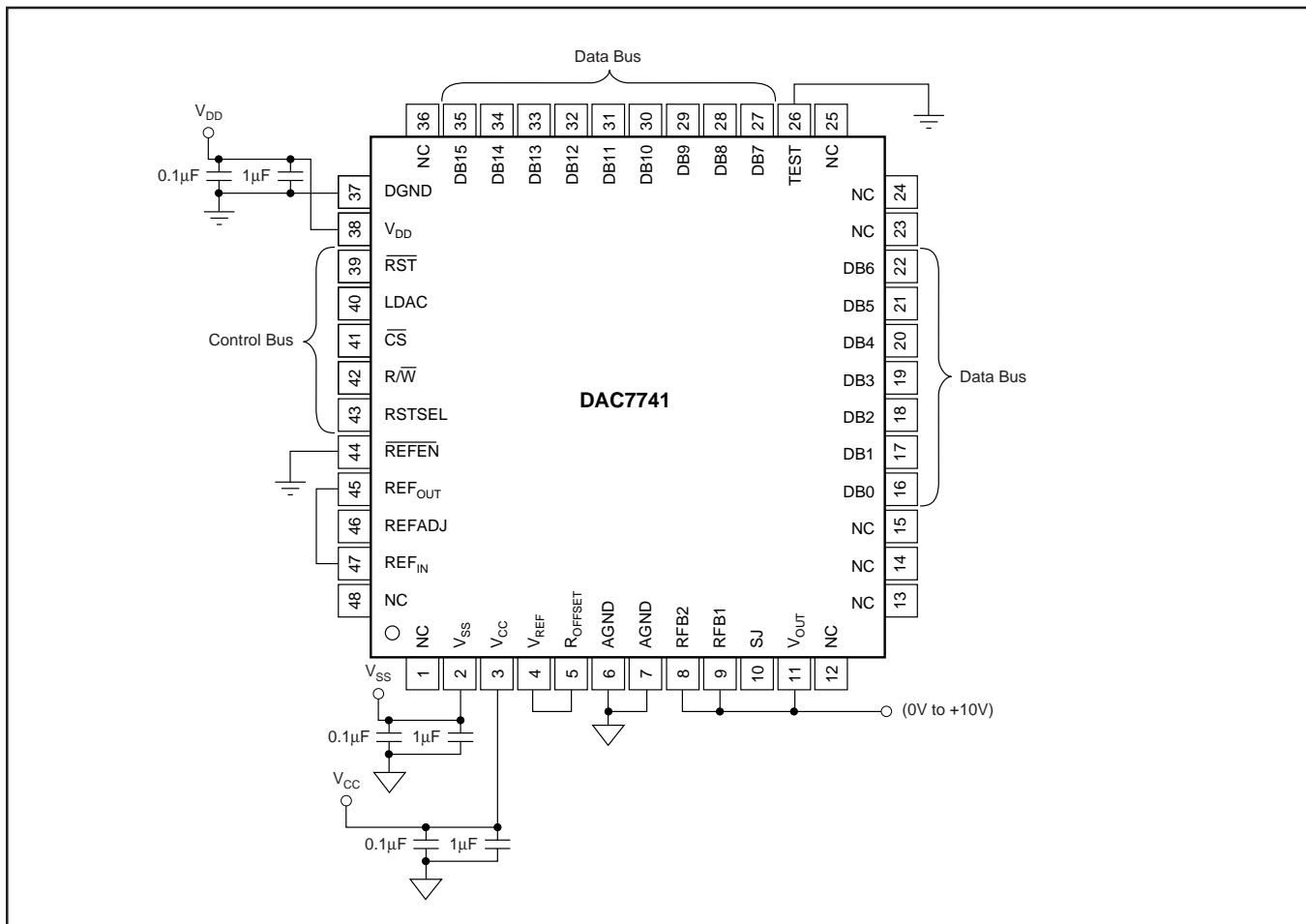

FIGURE 2. Basic Operation: V_{OUT} = 0 to +10V.

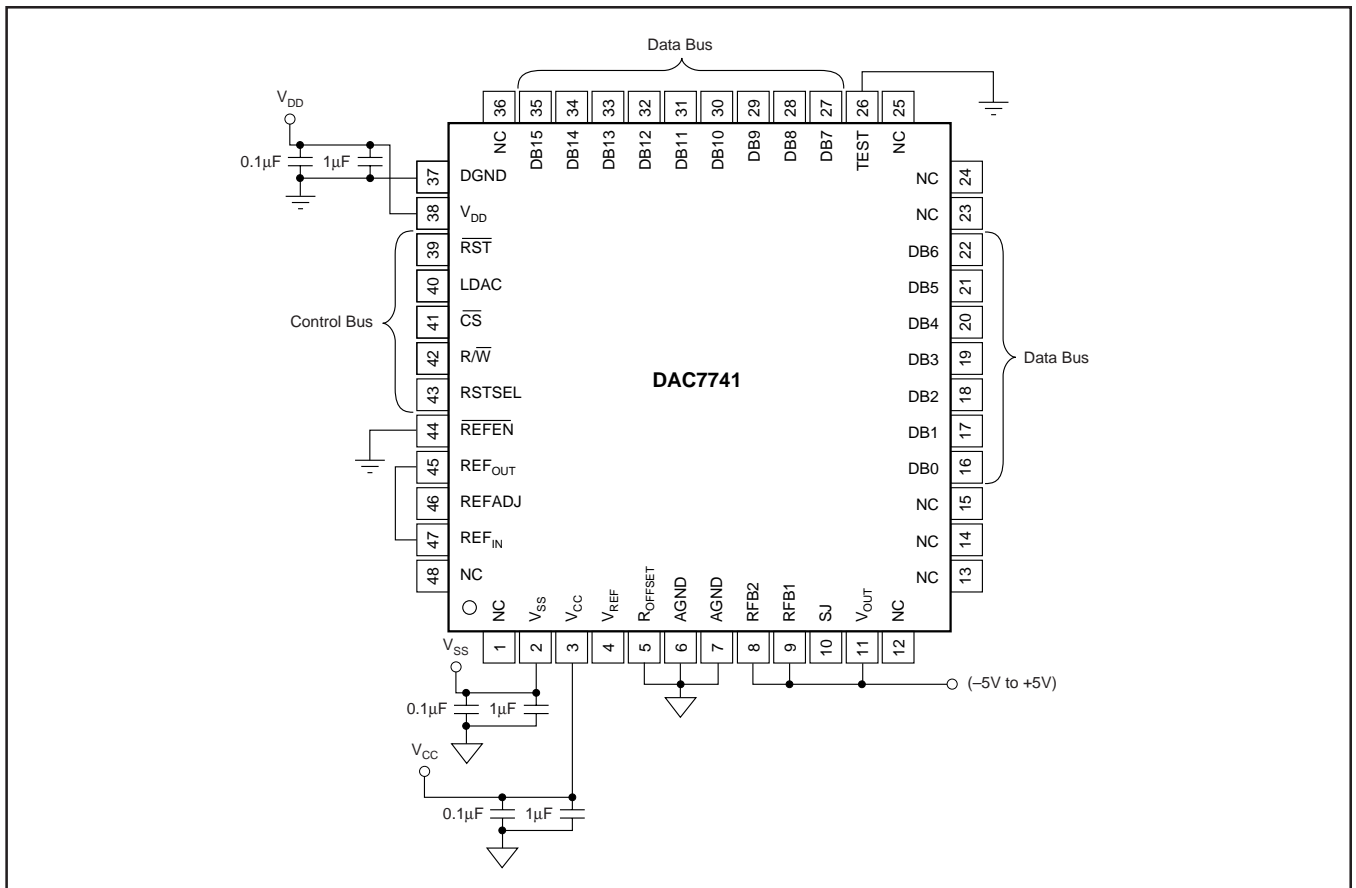

FIGURE 3. Basic Operation: $V_{OUT} = -5V$ to $+5V$.

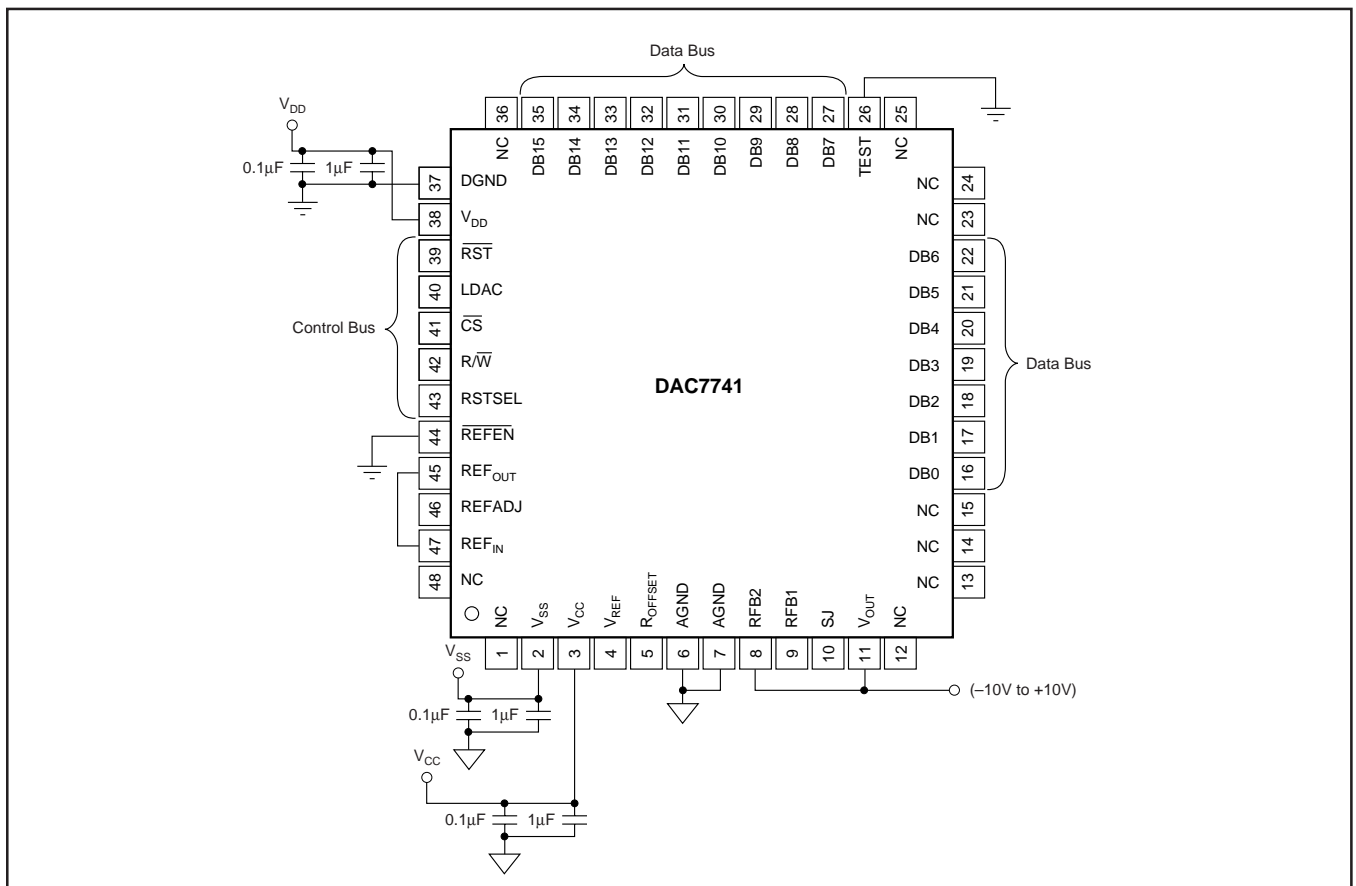

FIGURE 4. Basic Operation: $V_{OUT} = -10V$ to $+10V$.

ANALOG OUTPUTS

The output amplifier can swing to within 1.4V of the supply rails, specified over the -40°C to $+85^{\circ}\text{C}$ temperature range. This allows for a $\pm 10\text{V}$ DAC voltage output operation from $\pm 12\text{V}$ supplies with a typical 5% tolerance.

When the DAC7741 is configured for a unipolar, 0V to 10V output, a negative voltage supply is required. This is due to internal biasing of the output stage. Please refer to the "Electrical Characteristics" table for more information.

The minimum and maximum voltage output values are dependent upon the output configuration implemented and reference voltage applied to the DAC7741. Please note that V_{SS} (the negative power supply) must be in the range of -4.75V to -15.75V for unipolar operation. The voltage on V_{SS} sets several bias points within the converter and is required in all modes of operation. If V_{SS} is not in one of these two configurations, the bias values may be in error and proper operation of the device is not ensured.

Supply sequence is important in establishing the correct startup of the DAC. The digital supply (V_{DD}) needs to establish correct bias conditions before the analog supplies (V_{CC} , V_{SS}) are brought up. If the digital supply cannot be brought up first, it must come up before either analog supply (V_{CC} or V_{SS}), with the preferred sequence of: V_{SS} (device substrate), V_{DD} then V_{CC} .

REFERENCE INPUTS

The DAC7741 provides a built-in +10V voltage reference and on-chip buffer to allow external component reference drive. To use the internal reference, $\overline{\text{REFEN}}$ must be LOW, enabling the reference circuitry of the DAC7741 (see Table I) and the REF_{OUT} pin must be connected to REF_{IN} . This is the input to the on-chip reference buffer. The buffers output is provided at

REFEN	ACTION
1	Internal Reference disabled; $\text{REF}_{\text{OUT}} = \text{HIGH Impedance}$
0	Internal Reference enabled; $\text{REF}_{\text{OUT}} = +10\text{V}$

TABLE I. $\overline{\text{REFEN}}$ Action.

the V_{REF} pin. In this configuration, V_{REF} is used to setup the DAC7741 output amplifier into one of three voltage output modes as discussed earlier. V_{REF} can also be used to drive other system components requiring an external reference.

The internal reference of the DAC7741 can be disabled when use of an external reference is desired. When using an external reference, the reference input, REF_{IN} , can be any voltage between 4.75V (or $V_{SS} + 14\text{V}$, whichever is greater) and $V_{CC} - 1.4\text{V}$.

DIGITAL INTERFACE

Table III shows the data format for the DAC7741 and Table II illustrates the basic control logic of the device. The interface consists of a chip select input ($\overline{\text{CS}}$), read/write control input ($\text{R}/\overline{\text{W}}$), data inputs (DB0-DB15) and a load DAC input (LDAC). An asynchronous reset input ($\overline{\text{RST}}$) which is active low, is provided to simplify start-up conditions, periodic resets, or emergency resets to a known state, depending on the status of the reset select (RSTSEL) signal. The DAC code is provided via a 16-bit parallel interface, as shown in Table II. The input word makes up the DAC code to be loaded into the data input register of the device. The data is latched into the input register on rising $\overline{\text{CS}}$ and is loaded into the DAC register upon reception of a rising edge on the LDAC input. This action updates the analog output, V_{OUT} , to the desired value. LDAC inputs of multiple DAC7741 devices can be connected when a synchronized update of numerous DAC outputs is desired. Please refer to the timing section for more detailed data I/O information.

DIGITAL INPUT	ANALOG OUTPUT	
	Unipolar Configuration	Bipolar Configuration
	Unipolar Straight Binary	Bipolar Offset Binary
0x0000	Zero (0V)	-Full-Scale ($-V_{\text{REF}}$ or $-V_{\text{REF}}/2$)
0x0001	Zero + 1LSB	-Full-Scale + 1LSB
:	:	:
0x8000	1/2 Full-Scale	Bipolar Zero
0x8001	1/2 Full-Scale + 1LSB	Bipolar Zero + 1LSB
:	:	:
0xFFFF	Full-Scale ($V_{\text{REF}} - 1\text{LSB}$)	+Full-Scale ($+V_{\text{REF}} - 1\text{LSB}$ or $+V_{\text{REF}}/2 - 1\text{LSB}$)

TABLE III. DAC7741 Data Format.

CONTROL STATUS					COMMAND		
$\text{R}/\overline{\text{W}}$	$\overline{\text{CS}}$	$\overline{\text{RST}}$	RSTSEL	LDAC	Input Register	DAC Register	Mode
L	L	H	X	H, L, \downarrow	Write	Hold	Write Data to Input Register
X	H	H	X	\uparrow	Hold	Write	Update DAC register with data from input register.
L	L	H	X	\uparrow	Transparent	Write	Write DAC register directly from data bus
H	L	H	X	H, L, \downarrow	Read	Hold	Read data in input register.
X	H	H	X	H, L, \downarrow	Hold	Hold	No Change
X	X	L	L	X	Reset to Min-Scale	Reset to Min-Scale	Reset to Input and DAC Register (0000 _H) Min-Scale
X	X	L	H	X	Reset to Mid-Scale	Reset to Mid-Scale	Reset to Input and DAC Register (8000 _H) Mid-Scale

TABLE II. DAC7741 Logic Truth Table.

DAC RESET

The \overline{RST} and RSTSEL inputs control the reset of the analog output. The reset command is level triggered by a low signal on \overline{RST} . Once \overline{RST} is LOW, the DAC output will begin settling to the mid-scale or min-scale code depending on the state of the RSTSEL input. A HIGH value on RSTSEL will cause V_{OUT} to reset to the mid-scale code (8000H) and a LOW value will reset V_{OUT} to min-scale (0000H). A change in the state of the RSTSEL input while \overline{RST} is LOW will cause a corresponding change in the reset command selected internally and consequently change the output value of V_{OUT} of the DAC. Note that a valid reset signal also resets the input register of the DAC to the value specified by the state of RSTSEL.

GAIN AND OFFSET CALIBRATION

The architecture of the DAC7741 is designed in such a way as to allow for easily configurable offset and gain calibration using a minimum of external components. The DAC7741 has built-in feedback resistors and output amplifier summing points brought out of the package in order to make the absolute calibration possible. Figures 5 and 6 illustrate the relationship of offset and gain adjustments for the DAC7741 in a unipolar configuration and in a bipolar configuration, respectively.

When calibrating the DAC output, offset should be adjusted first to avoid first order interaction of adjustments. In unipolar mode, the DAC7741 offset is adjusted from code 0000H and for either bipolar mode, offset adjustments are made at code 8000H. Gain adjustment can then be made at code FFFFH for each configuration, where the output of the DAC should be at +10V for the 0V to +10V - 1LSB or $\pm 10V$ output range and +5V - 1LSB for the $\pm 5V$ output range. Figure 7 shows the generalized external offset and gain adjustment circuitry using potentiometers.

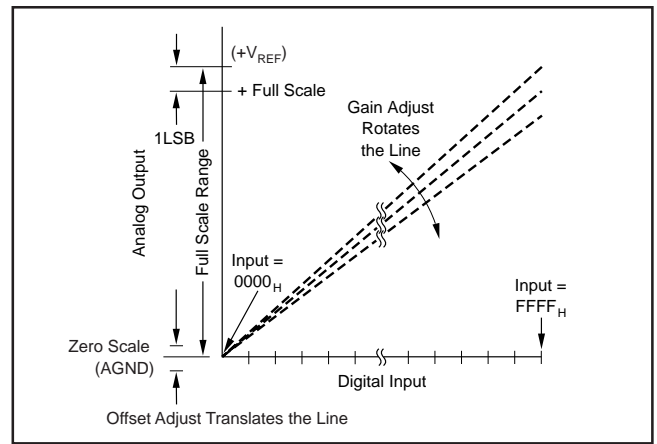

FIGURE 5. Relationship of Offset and Gain Adjustments for $V_{OUT} = 0V$ to +10V Output Configuration.

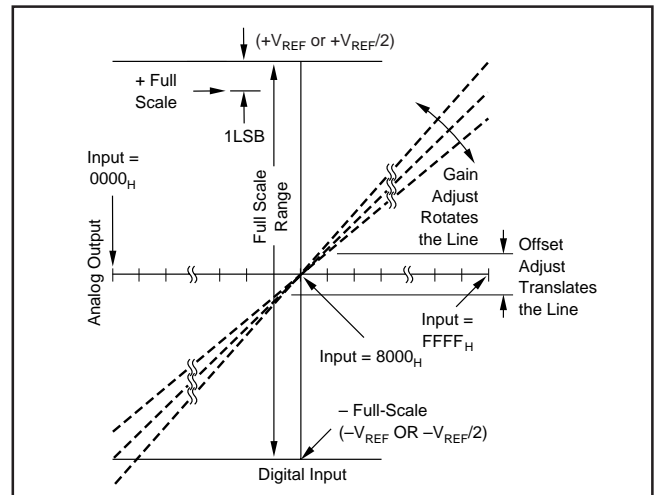

FIGURE 6. Relationship of Offset and Gain Adjustments for $V_{OUT} = -10V$ to +10V Output Configuration. (Same theory applies for $V_{OUT} = -5V$ to +5V).

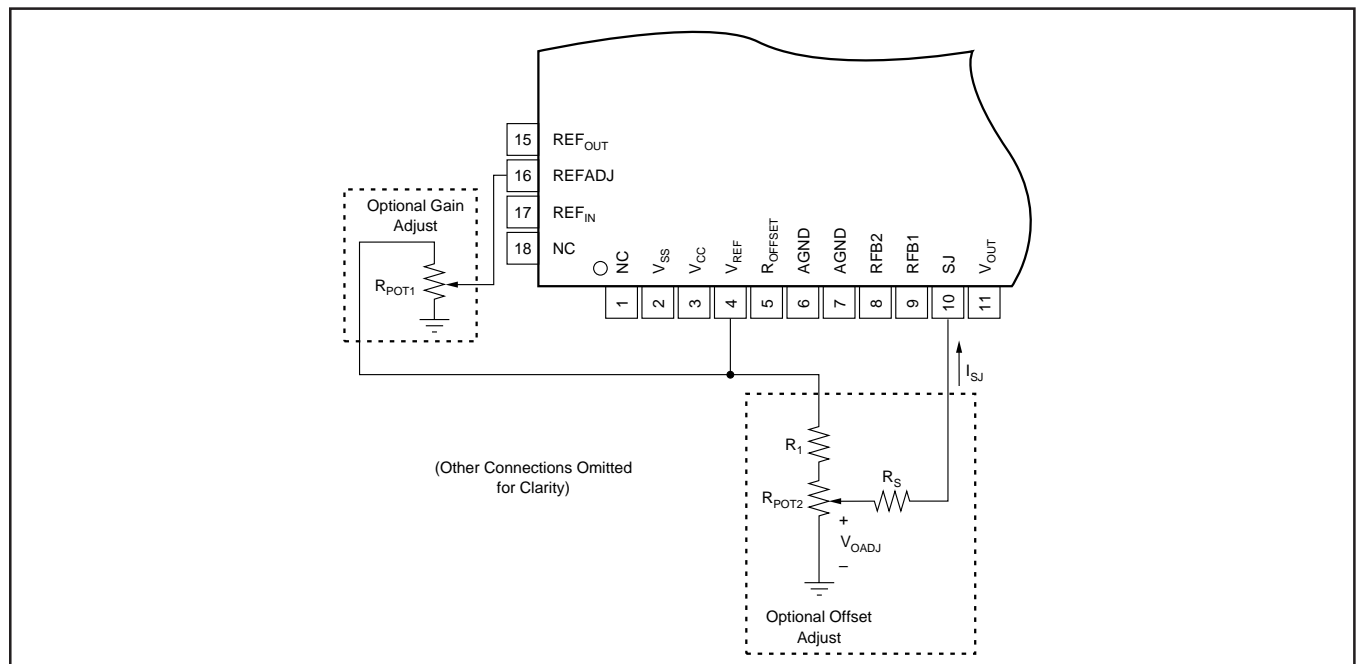

FIGURE 7. Generalized External Calibration Circuitry for Gain and Symmetrical Offset Adjustment.

OFFSET ADJUSTMENT

Offset adjustment is accomplished by introducing a small current into the summing junction (SJ) of the DAC7741. The voltage at SJ, or V_{SJ} , is dependent on the output configuration of the DAC7741. See Table IV for the required pin strapping for a given configuration and the nominal values of V_{SJ} for each output range.

REFERENCE CONFIGURATION	OUTPUT CONFIGURATION	PIN STRAPPING			$V_{SJ}^{(1)}$
		R_{OFFSET}	RFB1	RFB2	
Internal Reference	0V to +10V	to V_{REF}	to V_{OUT}	to V_{OUT}	+5V
	-10V to +10V	NC	NC	to V_{OUT}	+3.333V
	-5V to +5V	to AGND	to V_{OUT}	to V_{OUT}	+1.666V
External Reference	0V to V_{REF}	to V_{REF}	to V_{OUT}	to V_{OUT}	$V_{REF}/2$
	$-V_{REF}$ to V_{REF}	NC	NC	to V_{OUT}	$V_{REF}/3$
	$-V_{REF}/2$ to $V_{REF}/2$	to AGND	to V_{OUT}	to V_{OUT}	$V_{REF}/6$

NOTE: (1) Voltage measured at V_{SJ} for a given configuration.

TABLE IV. Nominal V_{SJ} vs. V_{OUT} and Reference Configuration.

The current level required to adjust the DAC7741 offset can be created by using a potentiometer divider as shown in Figure 7. Another alternative is to use a unipolar DAC in order to apply a voltage, V_{OAJ} , to the resistor R_S . A $\pm 2\mu A$ current range applied to SJ will ensure offset adjustment coverage of the $\pm 0.1\%$ maximum offset specification of the DAC7741.

When in a unipolar configuration ($V_{SJ} = 5V$), only a single resistor, R_S , is needed for symmetrical offset adjustment with a 0V to 10V V_{OAJ} range. When in one of the two bipolar configurations, V_{SJ} is either +3.333V ($\pm 10V$ range) or +1.666V ($\pm 5V$ range), and circuit values chosen to match those given in Table V will provide symmetrical offset adjust. Please refer to Figure 7 for component configuration.

OUTPUT CONFIGURATION	R_{POT2}	R_1	R_S	I_{SJ} RANGE	NOMINAL OFFSET ADJUSTMENT
0V to +10V	10K	0	2.5M	$\pm 2\mu A$	$\pm 25mV$
-10V to +10V	10K	5K	1.5M	$\pm 2.2\mu A$	$\pm 55mV$
-5V to +5V	10K	20K	1M	$\pm 1.7\mu A$	$\pm 21mV$

TABLE V. Recommended External Component Values for Symmetrical Offset Adjustment ($V_{REF} = 10V$).

Figure 8 illustrates the typical and minimum offset adjustment ranges provided by forcing a current at SJ for a given output voltage configuration.

GAIN ADJUSTMENT

When using the internal reference of the DAC7741, gain adjustment is performed by adjusting the internal reference voltage via the reference adjust pin, REFADJ. The effect of a reference voltage change on the gain of the DAC output can be seen in the generic equation (for unipolar configuration):

$$V_{OUT} = V_{REFIN} \cdot (N/65536)$$

where N is represented in decimal format and ranges from 0 to 65535.

REFADJ can be driven by a low impedance voltage source such as a unipolar, 0V to +10V DAC or a potentiometer (less

than 100k Ω) as shown in Figure 7. Since the input impedance of REFADJ is typically 50k Ω , the smaller the resistance of the potentiometer, the more linear the adjustment will be. A 10k Ω potentiometer is suggested if linearity of the reference adjustment is of concern.

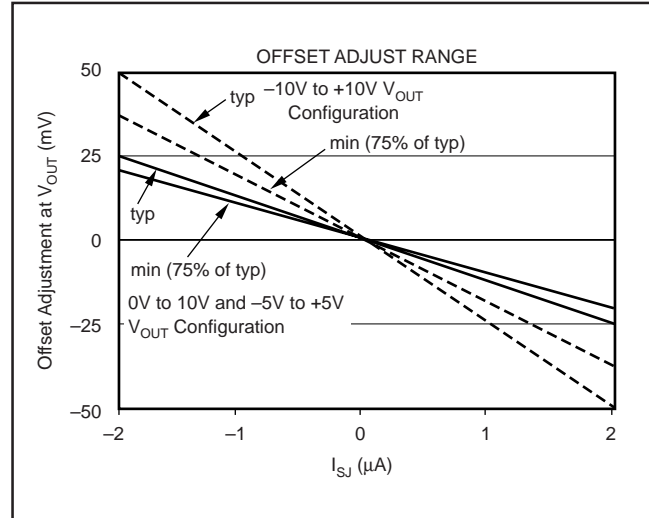

FIGURE 8. Offset Adjustment Transfer Characteristic.

When the DAC7741 internal reference is not used, gain adjustments can be made via trimming the external reference applied to the DAC at REF_{IN}. This can be accomplished through using a potentiometer, unipolar DAC, or other means of precision voltage adjustment to control the voltage presented to the DAC7741 by the external reference. Figure 9 and Table VI summarize the range of adjustment of the internal reference via REFADJ.

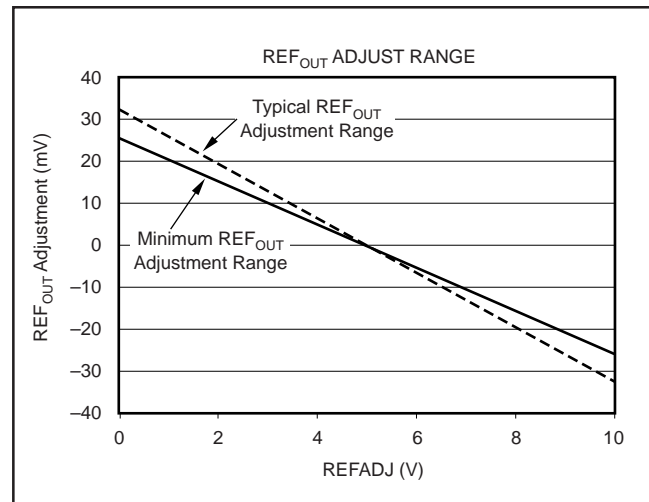

FIGURE 9. Internal Reference Adjustment Transfer Characteristic.

VOLTAGE AT REFADJ	REF _{OUT} VOLTAGE
REFADJ = 0V	10V + 25mV (min)
REFADJ = 5V or NC ⁽¹⁾	10V
REFADJ = 10V	10V - 25mV (max)

NOTE: "NC" is "Not Connected"

TABLE VI. Minimum Internal Reference Adjustment Range.

NOISE PERFORMANCE

Increased noise performance of the DAC output can be achieved by filtering the voltage reference input to the DAC7741. Figure 10 shows a typical internal reference filter schematic. A low-pass filter applied between the REF_{OUT} and REF_{IN} pins can increase noise immunity at the DAC and output amplifier. The REF_{OUT} pin can source a maximum of 50µA so care should be taken in order to avoid overloading the internal reference output.

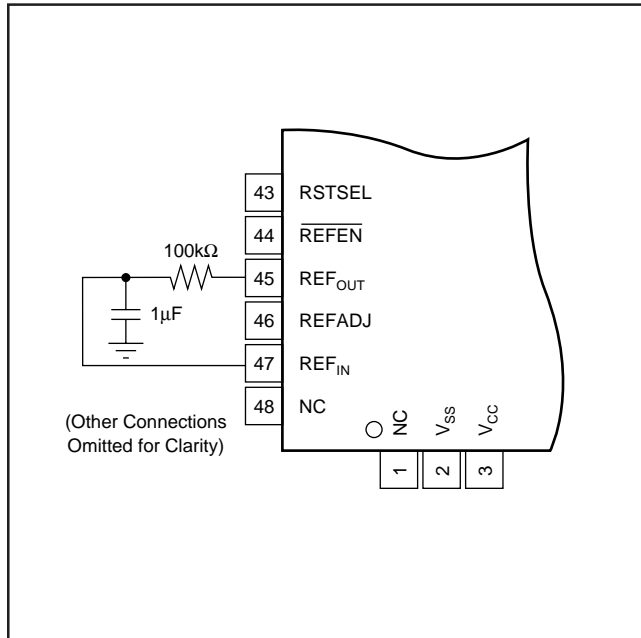

FIGURE 10. Internal Reference Filter.

LAYOUT

A precision analog component requires careful layout, adequate bypassing, and clean, well-regulated power supplies. The DAC7741 offers separate digital and analog supplies, as it will often be used in close proximity with digital logic, microcontrollers, microprocessors, and digital signal processors. The more digital logic present in the design and the higher the switching speed, the more important it will become to separate the analog and digital ground and supply planes at the device.

Since the DAC7741 has both analog and digital ground pins, return currents can be better controlled and have less effect on the DAC output error. Ideally, AGND would be connected directly to an analog ground plane and DGND to the digital ground plane. The analog ground plane would be separate from the ground connection for the digital components until they were connected at the power entry point of the system.

The voltages applied to V_{CC} and V_{SS} should be well regulated and low noise. Switching power supplies and dc/dc converters will often have high-frequency glitches or spikes riding on the output voltage. In addition, digital components can create similar high-frequency spikes as their internal logic switches states. This noise can easily couple into the DAC output voltage through various paths between the power connections and analog output.

In addition, a 1µF to 10µF bypass capacitor in parallel with a 0.1µF bypass capacitor is strongly recommended for each supply input. In some situations, additional bypassing may be required, such as a 100µF electrolytic capacitor or even a "Pi" filter made up of inductors and capacitors—all designed to essentially low-pass filter the analog supplies, removing any high frequency noise components.

PACKAGING INFORMATION

ORDERABLE DEVICE	STATUS(1)	PACKAGE TYPE	PACKAGE DRAWING	PINS	PACKAGE QTY
DAC7741Y/250	ACTIVE	LQFP	PT	48	250
DAC7741Y/2K	ACTIVE	LQFP	PT	48	2000
DAC7741YB/250	ACTIVE	LQFP	PT	48	250
DAC7741YB/2K	ACTIVE	LQFP	PT	48	2000
DAC7741YC/250	ACTIVE	LQFP	PT	48	250
DAC7741YC/2K	ACTIVE	LQFP	PT	48	2000
DAC7741YL/250	ACTIVE	LQFP	PT	48	250
DAC7741YL/2K	ACTIVE	LQFP	PT	48	2000

(1) The marketing status values are defined as follows:

ACTIVE: Product device recommended for new designs.

LIFEBUY: TI has announced that the device will be discontinued, and a lifetime-buy period is in effect.

NRND: Not recommended for new designs. Device is in production to support existing customers, but TI does not recommend using this part in a new design.

PREVIEW: Device has been announced but is not in production. Samples may or may not be available.

OBSOLETE: TI has discontinued the production of the device.

PT (S-PQFP-G48)

PLASTIC QUAD FLATPACK

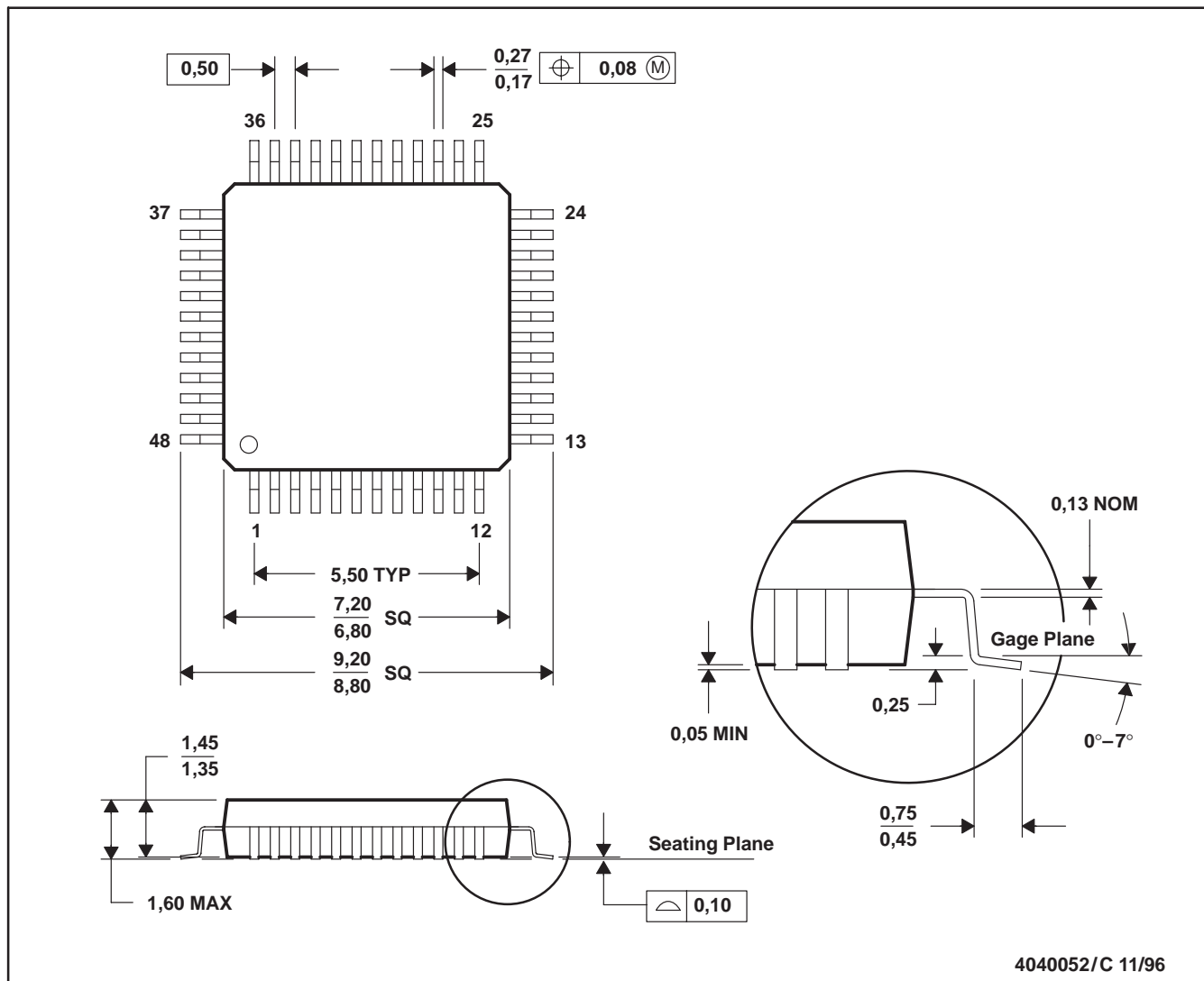

- NOTES: A. All linear dimensions are in millimeters.
 B. This drawing is subject to change without notice.
 C. Falls within JEDEC MS-026
 D. This may also be a thermally enhanced plastic package with leads connected to the die pads.

IMPORTANT NOTICE

Texas Instruments Incorporated and its subsidiaries (TI) reserve the right to make corrections, modifications, enhancements, improvements, and other changes to its products and services at any time and to discontinue any product or service without notice. Customers should obtain the latest relevant information before placing orders and should verify that such information is current and complete. All products are sold subject to TI's terms and conditions of sale supplied at the time of order acknowledgment.

TI warrants performance of its hardware products to the specifications applicable at the time of sale in accordance with TI's standard warranty. Testing and other quality control techniques are used to the extent TI deems necessary to support this warranty. Except where mandated by government requirements, testing of all parameters of each product is not necessarily performed.

TI assumes no liability for applications assistance or customer product design. Customers are responsible for their products and applications using TI components. To minimize the risks associated with customer products and applications, customers should provide adequate design and operating safeguards.

TI does not warrant or represent that any license, either express or implied, is granted under any TI patent right, copyright, mask work right, or other TI intellectual property right relating to any combination, machine, or process in which TI products or services are used. Information published by TI regarding third-party products or services does not constitute a license from TI to use such products or services or a warranty or endorsement thereof. Use of such information may require a license from a third party under the patents or other intellectual property of the third party, or a license from TI under the patents or other intellectual property of TI.

Reproduction of information in TI data books or data sheets is permissible only if reproduction is without alteration and is accompanied by all associated warranties, conditions, limitations, and notices. Reproduction of this information with alteration is an unfair and deceptive business practice. TI is not responsible or liable for such altered documentation.

Resale of TI products or services with statements different from or beyond the parameters stated by TI for that product or service voids all express and any implied warranties for the associated TI product or service and is an unfair and deceptive business practice. TI is not responsible or liable for any such statements.

Following are URLs where you can obtain information on other Texas Instruments products and application solutions:

Products		Applications	
Amplifiers	amplifier.ti.com	Audio	www.ti.com/audio
Data Converters	dataconverter.ti.com	Automotive	www.ti.com/automotive
DSP	dsp.ti.com	Broadband	www.ti.com/broadband
Interface	interface.ti.com	Digital Control	www.ti.com/digitalcontrol
Logic	logic.ti.com	Military	www.ti.com/military
Power Mgmt	power.ti.com	Optical Networking	www.ti.com/opticalnetwork
Microcontrollers	microcontroller.ti.com	Security	www.ti.com/security
		Telephony	www.ti.com/telephony
		Video & Imaging	www.ti.com/video
		Wireless	www.ti.com/wireless

Mailing Address: Texas Instruments
Post Office Box 655303 Dallas, Texas 75265

Copyright © 2003, Texas Instruments Incorporated