

ADV7177/ADV7178

FEATURES

ITU-R BT601/656 YCrCb to PAL/NTSC Video Encoder
 High Quality 9-Bit Video DACs
 Integral Nonlinearity <1 LSB at 9 Bits
 NTSC-M, PAL-M/N, PAL-B/D/G/H/I
 Single 27 MHz Crystal/Clock Required (×2 Oversampling)
 75 dB Video SNR
 32-Bit Direct Digital Synthesizer for Color Subcarrier
 Multistandard Video Output Support:
 Composite (CVBS)
 Component S-Video (Y/C)
 Component YUV and RGB
 Video Input Data Port Supports:
 CCIR-656 4:2:2 8-Bit Parallel Input Format
 4:2:2 16-Bit Parallel Input Format
 SMPTE 170M NTSC-Compatible Composite Video
 ITU-R BT.470 PAL-Compatible Composite Video
 Full Video Output Drive or Low Signal Drive Capability
 34.7 mA max into 37.5 Ω (Doubly-Terminated 75R)
 5 mA min with External Buffers
 Programmable Simultaneous Composite and S-VHS (VHS) Y/C or RGB (SCART)/YUV Video Outputs
 Programmable Luma Filters (Low-Pass/Notch/Extended)
 Programmable VBI (Vertical Blanking Interval)

Programmable Subcarrier Frequency and Phase
 Programmable LUMA Delay
 Individual ON/OFF Control of Each DAC
 CCIR and Square Pixel Operation
 Color Signal Control/Burst Signal Control
 Interlaced/Noninterlaced Operation
 Complete On-Chip Video Timing Generator
 OSD Support (ADV7177 Only)
 Programmable Multimode Master/Slave Operation
 Macrovision Antitaping Rev 7.01 (ADV7178 Only)**
 Closed Captioning Support
 Onboard Voltage Reference
 2-Wire Serial MPU Interface (I²C® Compatible)
 Single Supply +5 V or +3 V Operation
 Small 44-Lead PQFP Package
 Synchronous 27 MHz/13.5 MHz Clock O/P

APPLICATIONS

MPEG-1 and MPEG-2 Video, DVD, Digital Satellite/
 Cable Systems (Set Top Boxes/IRDs), Digital TVs,
 CD Video/Karaoke, Video Games, PC Video/Multimedia

GENERAL DESCRIPTION

The ADV7177/ADV7178 is an integrated digital video encoder that converts Digital CCIR-601 4:2:2 8- or 16-bit component video data into a standard analog baseband television signal

(Continued on page 11)

FUNCTIONAL BLOCK DIAGRAM

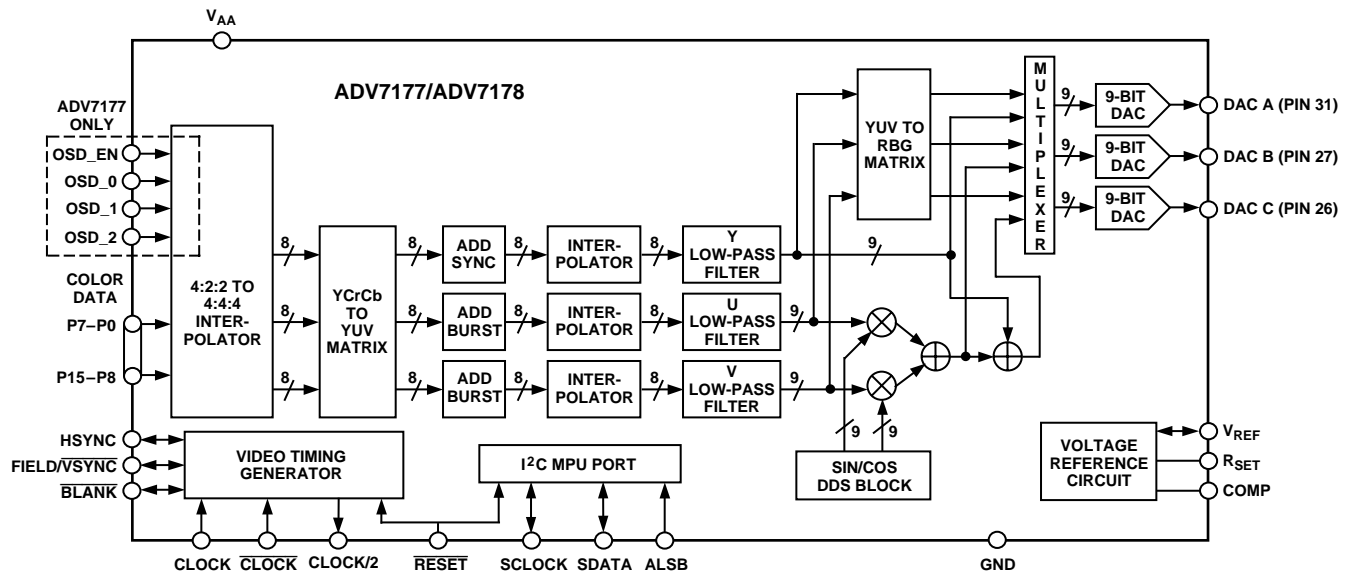

*Protected by U.S. Patent Numbers 5,343,196 and 5,442,355 and other intellectual property rights.

**This device is protected by U.S. Patent Numbers 4,631,603, 4,577,216, 4,819,098 and other intellectual property rights. The Macrovision anticopy process is licensed for noncommercial home use only, which is its sole intended use in the device. Please contact sales office for latest Macrovision version available.

NOTE: ITU-R and CCIR are used interchangeably in this document (ITU-R has replaced CCIR recommendations).

I²C is a registered trademark of Philips Corporation.

REV. 0

Information furnished by Analog Devices is believed to be accurate and reliable. However, no responsibility is assumed by Analog Devices for its use, nor for any infringements of patents or other rights of third parties which may result from its use. No license is granted by implication or otherwise under any patent or patent rights of Analog Devices.

One Technology Way, P.O. Box 9106, Norwood, MA 02062-9106, U.S.A.
 Tel: 781/329-4700 World Wide Web Site: <http://www.analog.com>
 Fax: 781/326-8703 © Analog Devices, Inc., 1998

ADV7177/ADV7178—SPECIFICATIONS

5 V SPECIFICATIONS ($V_{AA} = +5\text{ V} \pm 5\%$ ¹, $V_{REF} = 1.235\text{ V}$, $R_{SET} = 300\ \Omega$. All specifications T_{MIN} to T_{MAX} ² unless otherwise noted.)

| Parameter | Conditions ¹ | Min | Typ | Max | Units |
|--------------------------------------|--|-------|-------|-----------|---------------|
| STATIC PERFORMANCE ³ | | | | | |
| Resolution (Each DAC) | | | | 9 | Bits |
| Accuracy (Each DAC) | | | | ± 1.0 | LSB |
| Integral Nonlinearity | | | | ± 1.0 | LSB |
| Differential Nonlinearity | Guaranteed Monotonic | | | | |
| DIGITAL INPUTS ³ | | | | | |
| Input High Voltage, V_{INH} | | 2 | | | V |
| Input Low Voltage, V_{INL} | | | | 0.8 | V |
| Input Current, I_{IN} ⁴ | $V_{IN} = 0.4\text{ V}$ or 2.4 V | | | ± 1 | μA |
| Input Current, I_{IN} ⁵ | $V_{IN} = 0.4\text{ V}$ or 2.4 V | | | ± 50 | μA |
| Input Capacitance, C_{IN} | | | 10 | | pF |
| DIGITAL OUTPUTS ³ | | | | | |
| Output High Voltage, V_{OH} | $I_{SOURCE} = 400\ \mu\text{A}$ | 2.4 | | | V |
| Output Low Voltage, V_{OL} | $I_{SINK} = 3.2\text{ mA}$ | | | 0.4 | V |
| Three-State Leakage Current | | | | 10 | μA |
| Three-State Output Capacitance | | | 10 | | pF |
| ANALOG OUTPUTS ³ | | | | | |
| Output Current ⁶ | $R_{SET} = 300\ \Omega$, $R_L = 75\ \Omega$ | 16.5 | 17.35 | 18.5 | mA |
| Output Current ⁷ | | | 5 | | mA |
| DAC-to-DAC Matching | | | 0.6 | 5 | % |
| Output Compliance, V_{OC} | | 0 | | +1.4 | V |
| Output Impedance, R_{OUT} | | | 15 | | k Ω |
| Output Capacitance, C_{OUT} | $I_{OUT} = 0\text{ mA}$ | | | 30 | pF |
| VOLTAGE REFERENCE ³ | | | | | |
| Reference Range, V_{REF} | $I_{VREFOUT} = 20\ \mu\text{A}$ | 1.112 | 1.235 | 1.359 | V |
| POWER REQUIREMENTS ^{3, 8} | | | | | |
| V_{AA} | | 4.75 | 5.0 | 5.25 | V |
| Low Power Mode | | | | | |
| $I_{DAC}(\text{max})$ ⁹ | | | 62 | | mA |
| $I_{DAC}(\text{min})$ ⁹ | | | 25 | | mA |
| I_{CCT} ¹⁰ | | | 100 | 150 | mA |
| Power Supply Rejection Ratio | $COMP = 0.1\ \mu\text{F}$ | | 0.01 | 0.5 | %/% |

NOTES

¹The max/min specifications are guaranteed over this range. The max/min values are typical over 4.75 V to 5.25 V.

²Temperature range T_{MIN} to T_{MAX} : 0°C to +70°C.

³Guaranteed by characterization.

⁴All digital input pins except pins $\overline{\text{RESET}}$, $\overline{\text{OSD0}}$ and $\overline{\text{CLOCK}}$.

⁵Excluding all digital input pins except pins $\overline{\text{RESET}}$, $\overline{\text{OSD0}}$ and $\overline{\text{CLOCK}}$.

⁶Full drive into 75 Ω load.

⁷Minimum drive current (used with buffered/scaled output load).

⁸Power measurements are taken with Clock Frequency = 27 MHz. Max $T_J = 110^\circ\text{C}$.

⁹ I_{DAC} is the total current (min corresponds to 5 mA output per DAC, max corresponds to 18.5 mA output per DAC) to drive all three DACs. Turning off individual DACs reduces I_{DAC} correspondingly.

¹⁰ I_{CCT} (Circuit Current) is the continuous current required to drive the device.

Specifications subject to change without notice.

3.3 V SPECIFICATIONS ($V_{AA} = +3.0\text{ V} - 3.6\text{ V}^1$, $V_{REF} = 1.235\text{ V}$, $R_{SET} = 300\ \Omega$. All specifications T_{MIN} to T_{MAX}^2 unless otherwise noted.)

| Parameter | Conditions ¹ | Min | Typ | Max | Units |
|---|---|------|-------|-----------|---------------|
| STATIC PERFORMANCE³ | | | | | |
| Resolution (Each DAC) | | | | 9 | Bits |
| Accuracy (Each DAC) | | | | ± 0.5 | LSB |
| Integral Nonlinearity | | | | ± 0.5 | LSB |
| Differential Nonlinearity | Guaranteed Monotonic | | | ± 0.5 | LSB |
| DIGITAL INPUTS | | | | | |
| Input High Voltage, V_{INH} | | | 2 | | V |
| Input Low Voltage, V_{INL} | | | 0.8 | | V |
| Input Current, $I_{IN}^{3,4}$ | $V_{IN} = 0.4\text{ V or }2.4\text{ V}$ | | | ± 1 | μA |
| Input Current, $I_{IN}^{3,5}$ | $V_{IN} = 0.4\text{ V or }2.4\text{ V}$ | | | ± 50 | μA |
| Input Capacitance, C_{IN} | | | 10 | | pF |
| DIGITAL OUTPUTS | | | | | |
| Output High Voltage, V_{OH} | $I_{SOURCE} = 400\ \mu\text{A}$ | | 2.4 | | V |
| Output Low Voltage, V_{OL} | $I_{SINK} = 3.2\text{ mA}$ | | 0.4 | | V |
| Three-State Leakage Current ³ | | | | 10 | μA |
| Three-State Output Capacitance ³ | | | 10 | | pF |
| ANALOG OUTPUTS³ | | | | | |
| Output Current ^{6,7} | $R_{SET} = 300\ \Omega$, $R_L = 75\ \Omega$ | 16.5 | 17.35 | 18.5 | mA |
| Output Current ⁸ | | | 5 | | mA |
| DAC-to-DAC Matching | | | 2.0 | | % |
| Output Compliance, V_{OC} | | 0 | | +1.4 | V |
| Output Impedance, R_{OUT} | | | 15 | | k Ω |
| Output Capacitance, C_{OUT} | $I_{OUT} = 0\text{ mA}$ | | | 30 | pF |
| POWER REQUIREMENTS^{3,9} | | | | | |
| V_{AA} | | 3.0 | 3.3 | 3.6 | V |
| Normal Power Mode | | | | | |
| $I_{DAC}(\text{max})^{10}$ | $R_{SET} = 300\ \Omega$, $R_L = 150\ \Omega$ | | 113 | 116 | mA |
| $I_{DAC}(\text{min})^{10}$ | | | 15 | | mA |
| I_{CCT}^9 | | | 45 | | mA |
| Low Power Mode | | | | | |
| $I_{DAC}(\text{max})^{10}$ | | | 60 | | mA |
| $I_{DAC}(\text{min})^{10}$ | | | 25 | | mA |
| I_{CCT}^{11} | | | 45 | | mA |
| Power Supply Rejection Ratio | $COMP = 0.1\ \mu\text{F}$ | | 0.01 | 0.5 | %/% |

NOTES

¹The max/min specifications are guaranteed over this range. The max/min values are typical over 3.0 V to 3.6 V.

²Temperature range T_{MIN} to T_{MAX} : 0°C to +70°C.

³Guaranteed by characterization.

⁴All digital input pins except pins $\overline{\text{RESET}}$, $\overline{\text{OSD0}}$ and $\overline{\text{CLOCK}}$.

⁵Excluding all digital input pins except pins $\overline{\text{RESET}}$, $\overline{\text{OSD0}}$ and $\overline{\text{CLOCK}}$.

⁶Full drive into 75 Ω load.

⁷DACs can output 35 mA typically at 3.3 V ($R_{SET} = 150\ \Omega$ and $R_L = 75\ \Omega$), optimum performance obtained at 18 mA DAC current ($R_{SET} = 300\ \Omega$ and $R_L = 150\ \Omega$).

⁸Minimum drive current (used with buffered/scaled output load).

⁹Power measurements are taken with Clock Frequency = 27 MHz. Max $T_J = 110^\circ\text{C}$.

¹⁰ I_{DAC} is the total current (min corresponds to 5 mA output per DAC, max corresponds to 38 mA output per DAC) to drive all three DACs. Turning off individual DACs reduces I_{DAC} correspondingly.

¹¹ I_{CCT} (Circuit Current) is the continuous current required to drive the device.

Specifications subject to change without notice.

ADV7177/ADV7178—SPECIFICATIONS

5 V DYNAMIC SPECIFICATIONS¹ ($V_{AA} = +4.75\text{ V} - 5.25\text{ V}$ ¹, $V_{REF} = 1.235\text{ V}$, $R_{SET} = 300\ \Omega$. All specifications T_{MIN} to T_{MAX} ² unless otherwise noted.)

| Parameter | Conditions ¹ | Min | Typ | Max | Units |
|---|-----------------------------|-----|-----|-----|---------------|
| Filter Characteristics | | | | | |
| Luma Bandwidth ³ (Low-Pass Filter) | NTSC Mode | | | | |
| Stopband Cutoff | >54 dB Attenuation | 7.0 | | | MHz |
| Passband Cutoff $F_{3\text{ dB}}$ | >3 dB Attenuation | 4.2 | | | MHz |
| Chroma Bandwidth | NTSC Mode | | | | |
| Stopband Cutoff | >40 dB Attenuation | 3.2 | | | MHz |
| Passband Cutoff $F_{3\text{ dB}}$ | >3 dB Attenuation | 2.0 | | | MHz |
| Luma Bandwidth ³ (Low-Pass Filter) | PAL MODE | | | | |
| Stopband Cutoff | >50 dB Attenuation | 7.4 | | | MHz |
| Passband Cutoff $F_{3\text{ dB}}$ | >3 dB Attenuation | 5.0 | | | MHz |
| Chroma Bandwidth | PAL MODE | | | | |
| Stopband Cutoff | >40 dB Attenuation | 4.0 | | | MHz |
| Passband Cutoff $F_{3\text{ dB}}$ | >3 dB Attenuation | 2.4 | | | MHz |
| Differential Gain ⁴ | Lower Power Mode | | 2.0 | | % |
| Differential Phase ⁴ | Lower Power Mode | | 1.5 | | Degrees |
| SNR ⁴ (Pedestal) | RMS | | 75 | | dB rms |
| | Peak Periodic | | 70 | | dB p-p |
| SNR ⁴ (Ramp) | RMS | | 57 | | dB rms |
| | Peak Periodic | | 56 | | dB p-p |
| Hue Accuracy ⁴ | | | 1.2 | | Degrees |
| Color Saturation Accuracy ⁴ | | | 1.4 | | % |
| Chroma Nonlinear Gain ⁴ | Referenced to 40 IRE | | 1.0 | | $\pm\%$ |
| Chroma Nonlinear Phase ⁴ | NTSC | | 0.4 | | \pm Degrees |
| | PAL | | 0.6 | | \pm Degrees |
| Chroma/Luma Intermod ⁴ | Referenced to 714 mV (NTSC) | | 0.2 | | $\pm\%$ |
| | Referenced to 700 mV (PAL) | | 0.2 | | $\pm\%$ |
| Chroma/Luma Gain Ineq ⁴ | | | 0.6 | | $\pm\%$ |
| Chroma/Luma Delay Ineq ⁴ | | | 2.0 | | ns |
| Luminance Nonlinearity ⁴ | | | 1.2 | | $\pm\%$ |
| Chroma AM Noise ⁴ | | | 64 | | dB |
| Chroma PM Noise ⁴ | | | 62 | | dB |

NOTES

¹The max/min specifications are guaranteed over this range. The max/min values are typical over 4.75 V to 5.25 V.

²Temperature range T_{MIN} to T_{MAX} : 0°C to +70°C.

³These specifications are for the low-pass filter only and guaranteed by design. For other internal filters, see Figure 5.

⁴Guaranteed by characterization.

Specifications subject to change without notice.

3.3 V DYNAMIC SPECIFICATIONS¹ ($V_{AA} = +3.0\text{ V} - 3.6\text{ V}^1$, $V_{REF} = 1.235\text{ V}$, $R_{SET} = 300\ \Omega$. All specifications T_{MIN} to T_{MAX} ² unless otherwise noted.)

| Parameter | Conditions ¹ | Min | Typ | Max | Units |
|---|-------------------------|-----|-----|-----|---------|
| Filter Characteristics | | | | | |
| Luma Bandwidth ³ (Low-Pass Filter) | NTSC Mode | | | | |
| Stopband Cutoff | >54 dB Attenuation | 7.0 | | | MHz |
| Passband Cutoff $F_{3\text{ dB}}$ | >3 dB Attenuation | 4.2 | | | MHz |
| Chroma Bandwidth | NTSC Mode | | | | |
| Stopband Cutoff | >40 dB Attenuation | 3.2 | | | MHz |
| Passband Cutoff $F_{3\text{ dB}}$ | >3 dB Attenuation | 2.0 | | | MHz |
| Luma Bandwidth ³ (Low-Pass Filter) | PAL MODE | | | | |
| Stopband Cutoff | >50 dB Attenuation | 7.4 | | | MHz |
| Passband Cutoff $F_{3\text{ dB}}$ | >3 dB Attenuation | 5.0 | | | MHz |
| Chroma Bandwidth | PAL MODE | | | | |
| Stopband Cutoff | >40 dB Attenuation | 4.0 | | | MHz |
| Passband Cutoff $F_{3\text{ dB}}$ | >3 dB Attenuation | 2.4 | | | MHz |
| Differential Gain ⁴ | Normal Power Mode | | 1.0 | | % |
| Differential Phase ⁴ | Normal Power Mode | | 1.0 | | Degrees |
| SNR ⁴ (Pedestal) | RMS | | 70 | | dB rms |
| | Peak Periodic | | 64 | | dB p-p |
| SNR ⁴ (Ramp) | RMS | | 56 | | dB rms |
| | Peak Periodic | | 54 | | dB p-p |
| Hue Accuracy ⁴ | | | 1.2 | | Degrees |
| Color Saturation Accuracy ⁴ | | | 1.4 | | % |
| Luminance Nonlinearity ⁴ | | | 1.4 | | \pm % |
| Chroma AM Noise ⁴ | NTSC | | 64 | | dB |
| Chroma PM Noise ⁴ | NTSC | | 62 | | dB |
| Chroma AM Noise ⁴ | PAL | | 64 | | dB |
| Chroma PM Noise ⁴ | PAL | | 62 | | dB |

NOTES

¹The max/min specifications are guaranteed over this range. The max/min values are typical over 3.0 V to 3.6 V.

²Temperature range T_{MIN} to T_{MAX} : 0°C to +70°C.

³These specifications are for the low-pass filter only and guaranteed by design. For other internal filters, see Figure 5.

⁴Guaranteed by characterization.

Specifications subject to change without notice.

ADV7177/ADV7178

5 V TIMING SPECIFICATIONS ($V_{AA} = 4.75\text{ V} - 5.25\text{ V}$ ¹, $V_{REF} = 1.235\text{ V}$, $R_{SET} = 300\ \Omega$. All specifications T_{MIN} to T_{MAX} ² unless otherwise noted.)

| Parameter | Conditions | Min | Typ | Max | Units |
|--|--|-----|-----|---------------|---------------|
| MPU PORT ^{3, 4} | After This Period the First Clock Is Generated Relevant for Repeated Start Condition | | | | |
| SCLOCK Frequency | | 0 | | 100 | kHz |
| SCLOCK High Pulsewidth, t_1 | | 4.0 | | | μs |
| SCLOCK Low Pulsewidth, t_2 | | 4.7 | | | μs |
| Hold Time (Start Condition), t_3 | | 4.0 | | | μs |
| Setup Time (Start Condition), t_4 | | 4.7 | | | μs |
| Data Setup Time, t_5 | | 250 | | | ns |
| SDATA, SCLOCK Rise Time, t_6 | | | | 1 | μs |
| SDATA, SCLOCK Fall Time, t_7 | | | | 300 | ns |
| Setup Time (Stop Condition), t_8 | | 4.7 | | μs | |
| ANALOG OUTPUTS ^{3, 5} | | | | | |
| Analog Output Delay | | | 5 | | ns |
| DAC Analog Output Skew | | | 0 | | ns |
| CLOCK CONTROL AND PIXEL PORT ^{3, 6} | | | | | |
| f_{CLOCK} | | | 27 | | MHz |
| Clock High Time, t_9 | | 8 | | | ns |
| Clock Low Time, t_{10} | | 8 | | | ns |
| Data Setup Time, t_{11} | | 3.5 | | | ns |
| Data Hold Time, t_{12} | | 4 | | | ns |
| Control Setup Time, t_{11} | | 4 | | | ns |
| Control Hold Time, t_{12} | | 3 | | | ns |
| Digital Output Access Time, t_{13} | | | | 24 | ns |
| Digital Output Hold Time, t_{14} | | | 4 | | ns |
| Pipeline Delay, t_{15} | | | 37 | | Clock Cycles |
| RESET CONTROL ^{3, 4} | | | | | |
| RESET Low Time | | 6 | | | ns |
| INTERNAL CLOCK CONTROL | | | | | |
| Clock/2 Rise Time, t_{16} | | | 7 | | ns |
| Clock/2 Fall Time, t_{17} | | | 7 | | ns |
| OSD TIMING ⁴ | | | | | |
| OSD Setup Time, t_{18} | | | 6 | | ns |
| OSD Hold Time, t_{19} | | | 2 | | ns |

NOTES

¹The max/min specifications are guaranteed over this range.

²Temperature range T_{MIN} to T_{MAX} : 0°C to $+70^\circ\text{C}$.

³TTL input values are 0 to 3 volts, with input rise/fall times ≤ 3 ns, measured between the 10% and 90% points. Timing reference points at 50% for inputs and outputs. Analog output load ≤ 10 pF.

⁴Guaranteed by characterization.

⁵Output delay measured from the 50% point of the rising edge of CLOCK to the 50% point of full-scale transition.

⁶Pixel Port consists of the following:

Pixel Inputs: P15–P0
 Pixel Controls: HSYNC, FIELD/VSYNC, BLANK
 Clock Input: CLOCK

Specifications subject to change without notice.

3.3 V TIMING SPECIFICATIONS ($V_{AA} = +3.0\text{ V}$ – 3.6 V ¹, $V_{REF} = 1.235\text{ V}$, $R_{SET} = 300\ \Omega$. All specifications T_{MIN} to T_{MAX} ² unless otherwise noted.)

| Parameter | Conditions | Min | Typ | Max | Units | |
|---|---|-----|-----|-----|---------------|----|
| MPU PORT ^{3, 4} | | | | | | |
| SCLOCK Frequency | | 0 | | 100 | kHz | |
| SCLOCK High Pulsewidth, t_1 | | 4.0 | | | μs | |
| SCLOCK Low Pulsewidth, t_2 | | 4.7 | | | μs | |
| Hold Time (Start Condition), t_3 | After This Period the First Clock Is Generated Repeated for Start Condition | 4.0 | | | μs | |
| Setup Time (Start Condition), t_4 | | 4.7 | | | μs | |
| Data Setup Time, t_5 | | 250 | | | ns | |
| SDATA, SCLOCK Rise Time, t_6 | | | | 1 | μs | |
| SDATA, SCLOCK Fall Time, t_7 | | | | 300 | ns | |
| Setup Time (Stop Condition), t_8 | | 4.7 | | | μs | |
| ANALOG OUTPUTS ^{3, 5} | | | | | | |
| Analog Output Delay | | | | 7 | | ns |
| DAC Analog Output Skew | | | 0 | | ns | |
| CLOCK CONTROL AND PIXEL PORT ^{3, 4, 6} | | | | | | |
| f_{CLOCK} | | | 27 | | MHz | |
| Clock High Time, t_9 | | 8 | | | ns | |
| Clock Low Time, t_{10} | | 8 | | | ns | |
| Data Setup Time, t_{11} | | 3.5 | | | ns | |
| Data Hold Time, t_{12} | | 4 | | | ns | |
| Control Setup Time, t_{11} | | 4 | | | ns | |
| Control Hold Time, t_{12} | | 3 | | | ns | |
| Digital Output Access Time, t_{13} | | | | 24 | ns | |
| Digital Output Hold Time, t_{14} | | | 4 | | ns | |
| Pipeline Delay, t_{15} | | | 37 | | Clock Cycles | |
| RESET CONTROL ^{3, 4} | | | | | | |
| $\overline{\text{RESET}}$ Low Time | | 6 | | | ns | |
| INTERNAL CLOCK CONTROL | | | | | | |
| Clock/2 Rise Time, t_{16} | | | 10 | | ns | |
| Clock/2 Fall Time, t_{17} | | | 10 | | ns | |
| OSD TIMING ⁴ | | | | | | |
| OSD Setup Time, t_{18} | | | 10 | | ns | |
| OSD Hold Time, t_{19} | | | 2 | | ns | |

NOTES

¹The max/min specifications are guaranteed over this range.

²Temperature range T_{MIN} to T_{MAX} : 0°C to +70°C.

³TTL input values are 0 to 3 volts, with input rise/fall times ≤ 3 ns, measured between the 10% and 90% points. Timing reference points at 50% for inputs and outputs. Analog output load ≤ 10 pF.

⁴Guaranteed by characterization.

⁵Output delay measured from the 50% point of the rising edge of CLOCK to the 50% point of full-scale transition.

⁶Pixel Port consists of the following:

Pixel Inputs: P15–P0
 Pixel Controls: $\overline{\text{HSYNC}}$, $\overline{\text{FIELD/VSYNC}}$, $\overline{\text{BLANK}}$
 Clock Input: CLOCK

Specifications subject to change without notice.

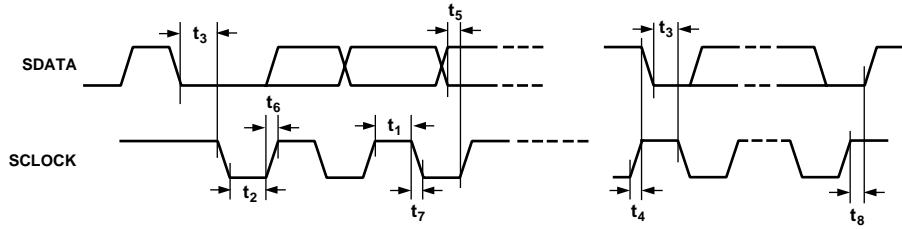

Figure 1. MPU Port Timing Diagram

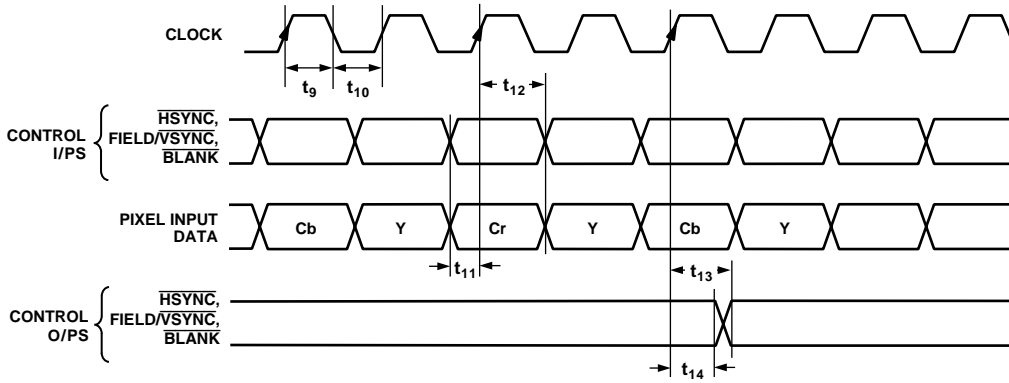

Figure 2. Pixel and Control Data Timing Diagram

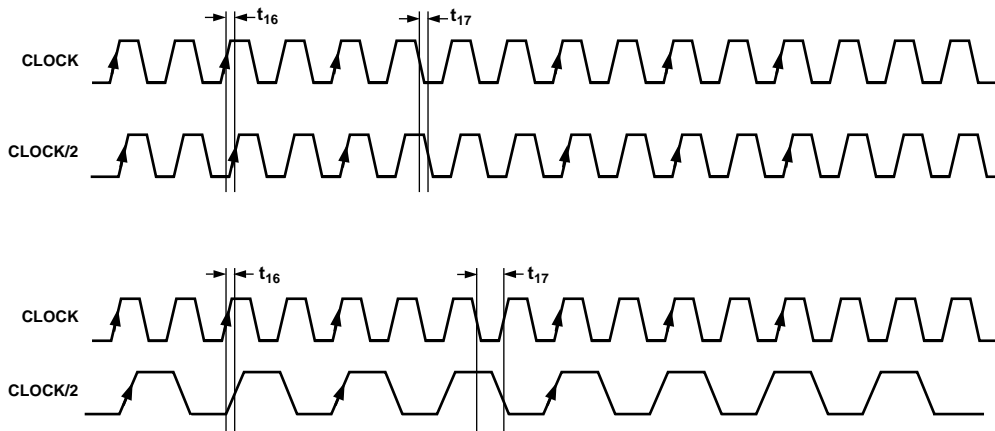

Figure 3. Internal Timing Diagram

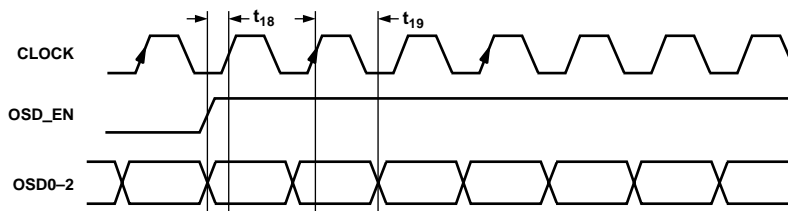

Figure 4. OSD Timing Diagram

ABSOLUTE MAXIMUM RATINGS¹

| | |
|--------------------------------------|---------------------------------|
| V_{AA} to GND | 7 V |
| Voltage on Any Digital Input Pin | GND – 0.5 V to V_{AA} + 0.5 V |
| Storage Temperature (T_S) | –65°C to +150°C |
| Junction Temperature (T_J) | +150°C |
| Lead Temperature (Soldering, 10 sec) | +260°C |
| Analog Outputs to GND ² | GND – 0.5 to V_{AA} |

NOTES

¹Stresses above those listed under Absolute Maximum Ratings may cause permanent damage to the device. This is a stress rating only; functional operation of the device at these or any other conditions above those listed in the operational sections of this specification is not implied. Exposure to absolute maximum rating conditions for extended periods may affect device reliability.

²Analog output short circuit to any power supply or common can be of an indefinite duration.

ORDERING GUIDE

| Model | Temperature Range | Package Description | Package Option |
|-----------|-------------------|-----------------------|----------------|
| ADV7178KS | 0°C to +70°C | Plastic Quad Flatpack | S-44 |
| ADV7177KS | 0°C to +70°C | Plastic Quad Flatpack | S-44 |

PACKAGE THERMAL PERFORMANCE

The 44-lead PQFP package used for this device has a junction-to-ambient thermal resistance (θ_{JA}) in still air on a four-layer PCB of 53.2°C/W. The junction-to-case thermal resistance (θ_{JC}) is 18.8°C/W.

Care must be taken when operating the part in certain conditions to prevent overheating. Table I illustrates what conditions are to be used when using the part.

**Table I. Allowable Operating Conditions for ADV7177/
ADV7178 in 44-Lead PQFP Package**

| Condition | 5 V | 3 V |
|------------------------------------|-----|-----|
| 3 DACs ON, Double 75R ¹ | No | Yes |
| 3 DACs ON, Low Power ² | Yes | Yes |
| 3 DACs ON, Buffered ³ | Yes | Yes |
| 2 DACs ON, Double 75R | No | Yes |
| 2 DACs ON, Low Power | Yes | Yes |
| 2 DACs ON, Buffered | Yes | Yes |

NOTES

¹DAC ON, Double 75R refers to a condition where the DACs are terminated into a double 75R load and low power mode is disabled.

²DAC ON, Low Power refers to a condition where the DACs are terminated in a double 75R load and low power mode is enabled.

³DAC ON, Buffered refers to a condition where the DAC current is reduced to 5 mA and external buffers are used to drive the video loads.

PIN CONFIGURATION

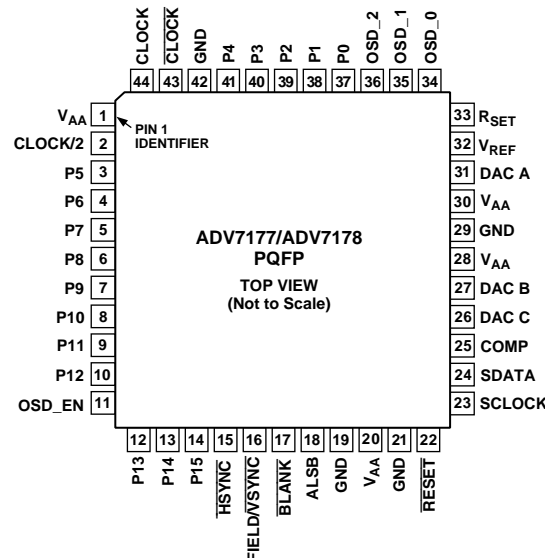

CAUTION

ESD (electrostatic discharge) sensitive device. Electrostatic charges as high as 4000 V readily accumulate on the human body and test equipment and can discharge without detection. Although the ADV7177/ADV7178 feature proprietary ESD protection circuitry, permanent damage may occur on devices subjected to high energy electrostatic discharges. Therefore, proper ESD precautions are recommended to avoid performance degradation or loss of functionality.



ADV7177/ADV7178

PIN FUNCTION DESCRIPTIONS

| Pin No. | Mnemonic | Input/Output | Function |
|--------------------|----------------------------------|--------------|---|
| 1, 20, 28, 30 | V _{AA} | P | +5 V Supply. |
| 2 | CLOCK/2 | O | Synchronous Clock output signal. Can be either 27 MHz or 13.5 MHz; this can be controlled by MR32 and MR33 in Mode Register 3. |
| 3–10, 12–14, 37–41 | P15–P0 | I | 8-Bit 4:2:2 Multiplexed YCrCb Pixel Port (P7–P0) or 16-Bit YCrCb Pixel Port (P15–P0). P0 represents the LSB. |
| 11 | OSD_EN | I | Enables OSD input data on the video outputs. |
| 15 | $\overline{\text{HSYNC}}$ | I/O | $\overline{\text{HSYNC}}$ (Modes 1 and 2) Control Signal. This pin may be configured to output (Master Mode) or accept (Slave Mode) Sync signals. |
| 16 | FIELD/ $\overline{\text{VSYNC}}$ | I/O | Dual Function FIELD (Mode 1) and $\overline{\text{VSYNC}}$ (Mode 2) Control Signal. This pin may be configured to output (Master Mode) or accept (Slave Mode) these control signals. |
| 17 | $\overline{\text{BLANK}}$ | I/O | Video Blanking Control Signal. The pixel inputs are ignored when this is Logic Level “0.” This signal is optional. |
| 18 | ALSB | I | TTL Address Input. This signal sets up the LSB of the MPU address. |
| 19, 21, 29, 42 | GND | G | Ground Pin. |
| 22 | $\overline{\text{RESET}}$ | I | The input resets the on-chip timing generator and sets the ADV7177/ADV7178 into default mode. This is NTSC operation, Timing Slave Mode 0, 8-Bit Operation, 2 × Composite and S VHS out. |
| 23 | SCLOCK | I | MPU Port Serial Interface Clock Input. |
| 24 | SDATA | I/O | MPU Port Serial Data Input/Output. |
| 25 | COMP | O | Compensation Pin. Connect a 0.1 μF Capacitor from COMP to V _{AA} . |
| 26 | DAC C | O | DAC C Analog Output. |
| 27 | DAC B | O | DAC B Analog Output. |
| 31 | DAC A | O | DAC A Analog Output. |
| 32 | V _{REF} | I/O | Voltage Reference Input for DACs or Voltage Reference Output (1.2 V). |
| 33 | R _{SET} | I | A 300 Ω resistor connected from this pin to GND is used to control full-scale amplitudes of the Video Signals. |
| 34–36 | OSD_0–2 | I | On Screen Display Inputs. |
| 43 | $\overline{\text{CLOCK}}$ | O | Crystal Oscillator output (to crystal). Leave unconnected if no crystal is used. |
| 44 | CLOCK | I | Crystal Oscillator input. If no crystal is used this pin can be driven by an external TTL Clock source; it requires a stable 27 MHz reference Clock for standard operation. Alternatively, a 24.52 MHz (NTSC) or 29.5 MHz (PAL) can be used for square pixel operation. |

(Continued from page 1)

compatible with worldwide standards. The 4:2:2 YUV video data is interpolated to two times the pixel rate. The color-difference components (UV) are quadrature modulated using a subcarrier frequency generated by an on-chip 32-bit digital synthesizer (also running at two times the pixel rate). The two times pixel rate sampling allows for better signal-to-noise ratio. A 32-bit DDS with a 9-bit look-up table produces a superior subcarrier in terms of both frequency and phase. In addition to the composite output signal, there is the facility to output S-Video (Y/C) video, YUV or RGB video.

Each analog output is capable of driving the full video-level (34.7 mA) signal into an unbuffered, doubly terminated 75 Ω load. With external buffering, the user has the additional option to scale back the DAC output current to 5 mA min, thereby significantly reducing the power dissipation of the device.

The ADV7177/ADV7178 also supports both PAL and NTSC square pixel operation.

The output video frames are synchronized with the incoming data timing reference codes. Optionally, the encoder accepts (and can generate) HSYNC, VSYNC and FIELD timing signals. These timing signals can be adjusted to change pulsewidth and position while the part is in the master mode. The encoder requires a single two times pixel rate (27 MHz) clock for standard operation. Alternatively, the encoder requires a 24.54 MHz clock for NTSC or 29.5 MHz clock for PAL square pixel mode operation. All internal timing is generated on-chip.

The ADV7177/ADV7178 modes are set up over a two-wire serial bidirectional port (I²C-Compatible) with two slave addresses.

Functionally the ADV7178 and ADV7177 are the same with the exception that the ADV7178 can output the Macrovision anticopy algorithm, and OSD is only supported on the ADV7177.

The ADV7177/ADV7178 is packaged in a 44-lead thermally enhanced PQFP package.

DATA PATH DESCRIPTION

For PAL B, D, G, H, I, M, N and NTSC M, N modes, YCrCb 4:2:2 data is input via the CCIR-656 compatible pixel port at a 27 MHz data rate. The pixel data is demultiplexed to from

three data paths. Y typically has a range of 16 to 235, Cr and Cb typically have a range of 128 ± 112; however, it is possible to input data from 1 to 254 on both Y, Cb and Cr. The ADV7177/ADV7178 supports PAL (B, D, G, H, I, N, M) and NTSC (with and without Pedestal) standards. The appropriate SYNC, $\overline{\text{BLANK}}$ and Burst levels are added to the YCrCb data. Macrovision antitaping (ADV7178 only), closed captioning, OSD (ADV7177 only), and teletext levels are also added to Y, and the resultant data is interpolated to a rate of 27 MHz. The interpolated data is filtered and scaled by three digital FIR filters.

The U and V signals are modulated by the appropriate subcarrier sine/cosine phases and added together to make up the chrominance signal. The luma (Y) signal can be delayed 1–3 luma cycles (each cycle is 74 ns) with respect to the chroma signal. The luma and chroma signals are then added together to make up the composite video signal. All edges are slew rate limited.

The YCrCb data is also used to generate RGB data with appropriate SYNC and $\overline{\text{BLANK}}$ levels. The RGB data is in synchronization with the composite video output. Alternatively analog YUV data can be generated instead of RGB.

The three 9-bit DACs can be used to output:

1. RGB Video.
2. YUV Video
3. One Composite Video Signal + LUMA and CHROMA (S-Video).

Alternatively, each DAC can be individually powered off if not required.

Video output levels are illustrated in Appendix 3, Appendix 4 and Appendix 5.

INTERNAL FILTER RESPONSE

The Y filter supports several different frequency responses, including two 4.5 MHz/5.0 MHz low-pass responses, PAL/NTSC subcarrier notch responses and a PAL/NTSC extended response. The U and V filters have a 2/2.4 MHz low-pass response for NTSC/PAL. These filter characteristics are illustrated in Figures 7 to 13.

| FILTER SELECTION | PASSBAND CUTOFF (MHz) | | PASSBAND RIPPLE (dB) | STOPBAND CUTOFF (MHz) | STOPBAND ATTENUATION (dB) | F ₃ dB | |
|------------------|-----------------------|------|----------------------|-----------------------|---------------------------|-------------------|------|
| | MR04 | MR03 | | | | | |
| NTSC | 0 | 0 | 2.3 | 0.026 | 7.0 | >54 | 4.2 |
| PAL | 0 | 0 | 3.4 | 0.098 | 7.3 | >50 | 5.0 |
| NTSC | 0 | 1 | 1.0 | 0.085 | 3.57 | >27.6 | 2.1 |
| PAL | 0 | 1 | 1.4 | 0.107 | 4.43 | >29.3 | 2.7 |
| NTSC/PAL | 1 | 0 | 4.0 | 0.150 | 7.5 | >40 | 5.35 |
| NTSC | 1 | 1 | 2.3 | 0.054 | 7.0 | >54 | 4.2 |
| PAL | 1 | 1 | 3.4 | 0.106 | 7.3 | >50.3 | 5.0 |

Figure 5. Luminance Internal Filter Specifications

| FILTER SELECTION | PASSBAND CUTOFF (MHz) | PASSBAND RIPPLE (dB) | STOPBAND CUTOFF (MHz) | STOPBAND ATTENUATION (dB) | ATTENUATION @ 1.3MHz (dB) | F ₃ dB |
|------------------|-----------------------|----------------------|-----------------------|---------------------------|---------------------------|-------------------|
| NTSC | 1.0 | 0.085 | 3.2 | >40 | 0.3 | 2.05 |
| PAL | 1.3 | 0.04 | 4.0 | >40 | 0.02 | 2.45 |

Figure 6. Chrominance Internal Filter Specifications

ADV7177/ADV7178

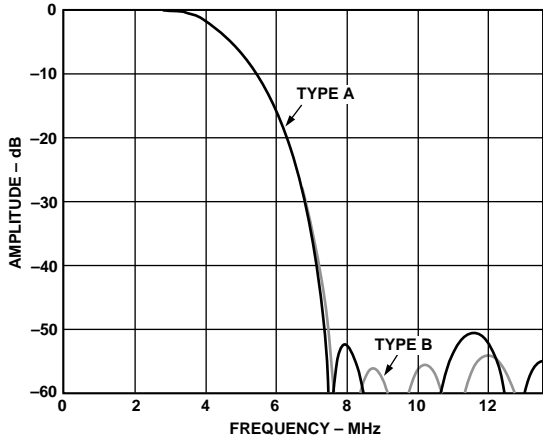

Figure 7. NTSC Low-Pass Filter

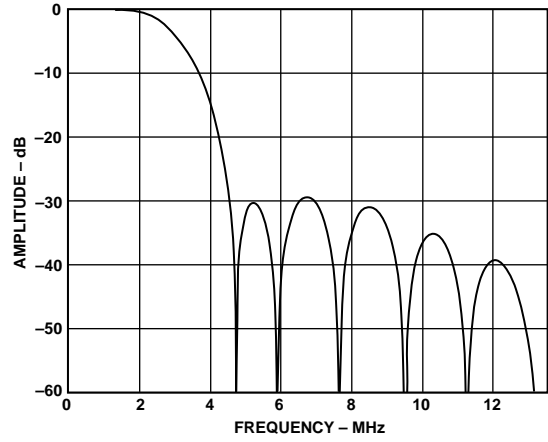

Figure 10. PAL Notch Filter

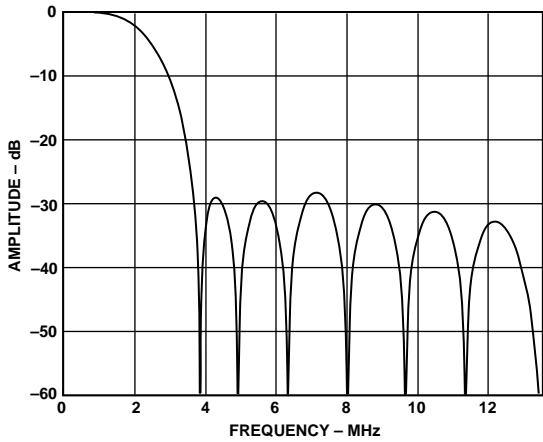

Figure 8. NTSC Notch Filter

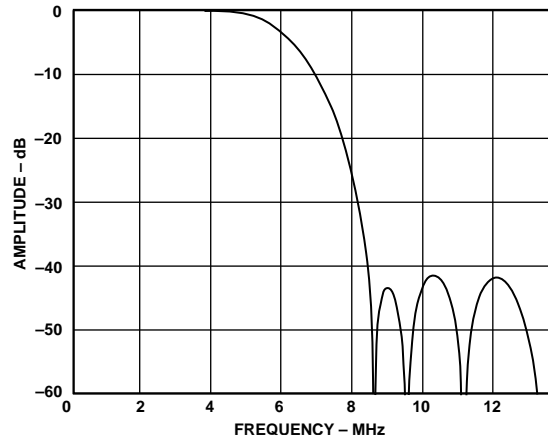

Figure 11. NTSC/PAL Extended Mode Filter

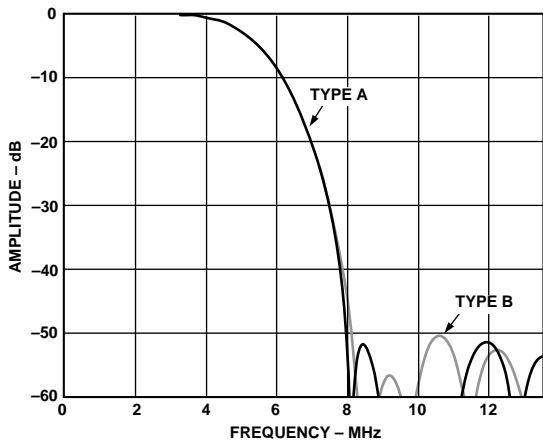

Figure 9. PAL Low-Pass Filter

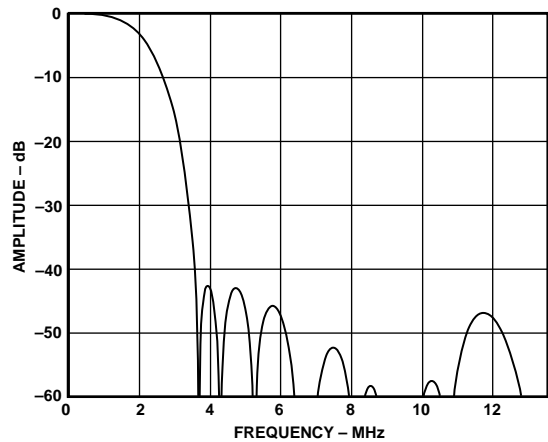

Figure 12. NTSC UV Filter

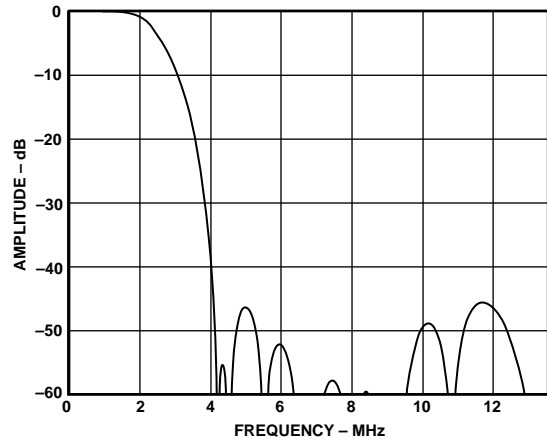

Figure 13. PAL UV Filter

COLOR BAR GENERATION

The ADV7177/ADV7178 can be configured to generate 75% amplitude, 75% saturation (75/7.5/75/7.5) for NTSC or 75% amplitude, 100% saturation (100/0/75/0) for PAL color bars. These are enabled by setting MR17 of Mode Register 1 to Logic “1.”

SQUARE PIXEL MODE

The ADV7177/ADV7178 can be used to operate in square pixel mode. For NTSC operation an input clock of 24.5454 MHz is required. Alternatively an input clock of 29.5 MHz is required for PAL operation. The internal timing logic adjusts accordingly for square pixel mode operation.

COLOR SIGNAL CONTROL

The color information can be switched on and off the video output using Bit MR24 of Mode Register 2.

BURST SIGNAL CONTROL

The burst information can be switched on and off the video output using Bit MR25 of Mode Register 2.

NTSC PEDESTAL CONTROL

The pedestal on both odd and even fields can be controlled on a line-by-line basis using the NTSC Pedestal Control Registers. This allows the pedestals to be controlled during the vertical blanking interval (Lines 10 to 25 and Lines 273 to 288).

PIXEL TIMING DESCRIPTION

The ADV7177/ADV7178 can operate in either 8-bit or 16-bit YCrCb Mode.

8-Bit YCrCb Mode

This default mode accepts multiplexed YCrCb inputs through the P7–P0 pixel inputs. The inputs follow the sequence Cb0, Y0 Cr0, Y1 Cb1, Y2, etc. The Y, Cb and Cr data are input on a rising clock edge.

16-Bit YCrCb Mode

This mode accepts Y inputs through the P7–P0 pixel inputs and multiplexed CrCb inputs through the P15–P8 pixel inputs. The data is loaded on every second rising edge of CLOCK. The inputs follow the sequence Cb0, Y0 Cr0, Y1 Cb1, Y2, etc.

OSD

The ADV7177 supports OSD. There are twelve 8-bit OSD registers, loaded with data from the four most significant bits of Y, Cb, Cr input pixel data bytes. A choice of eight colors can, therefore, be selected via the OSD_0, OSD_1, OSD_2 pins, each color being a combination of 12 bits of Y, Cb, Cr pixel data. The display is under control of the OSD_EN pin. The OSD window can be an entire screen or just one pixel, its size may change by using the OSD_EN signal to control the width on a line-by-line basis. Figure 4 illustrates OSD timing on the ADV7177.

SUBCARRIER RESET

The ADV7177/ADV7178 can be used in subcarrier reset mode. The subcarrier will reset to Field 0 at the start of the following field when a low to high transition occurs on this input pin.

VIDEO TIMING DESCRIPTION

The ADV7177/ADV7178 is intended to interface to off-the-shelf MPEG1 and MPEG2 decoders. Consequently, the ADV7177/ADV7178 accepts 4:2:2 YCrCb pixel data via a CCIR-656 pixel port, and has several video timing modes of operation that allow it to be configured as either system master video timing generator or a slave to the system video timing generator. The ADV7177/ADV7178 generates all of the required horizontal and vertical timing periods and levels for the analog video outputs.

The ADV7177/ADV7178 calculates the width and placement of analog sync pulses, blanking levels and color burst envelopes. Color bursts are disabled on appropriate lines, and serration and equalization pulses are inserted where required.

In addition, the ADV7177/ADV7178 supports a PAL or NTSC square pixel operation in slave mode. The part requires an input pixel clock of 24.5454 MHz for NTSC and an input pixel clock of 29.5 MHz for PAL. The internal horizontal line counters place the various video waveform sections in the correct location for the new clock frequencies.

The ADV7177/ADV7178 has four distinct master and four distinct slave timing configurations. Timing Control is established with the bidirectional SYNC, BLANK and FIELD/VSynch pins. Timing Mode Register 1 can also be used to vary the timing pulsewidths and where they occur in relation to each other.

ADV7177/ADV7178

Vertical Blanking Data Insertion

It is possible to allow encoding of incoming YCbCr data on those lines of VBI that do not bear line sync or pre-/post-equalization pulses (see Figures 14 to 25). This mode of operation is called “Partial Blanking” and is selected by setting MR31 to 1. It allows the insertion of any VBI data (Opened VBI) into the encoded output waveform. This data is present in digitized incoming YCbCr data stream (e.g., WSS data, CGMS, VPS, etc.). Alternatively, the entire VBI may be blanked (no VBI data inserted) on these lines by setting MR31 to 0.

The complete VBI comprises of the following lines:

525/60 Systems, Lines 525 to 21 for Field 1 and Lines 262 to Line 284 for Field 2.

625/50 Systems, Lines 624 to Line 22 and Lines 311 to 335.

The “Opened VBI” consists of:

525/60 Systems, Lines 10 to 21 for Field 1 and second half of Line 273 to Line 284 for Field 2.

625/50 Systems, Line 7 to Line 22 and Lines 319 to 335.

Mode 0 (CCIR-656): Slave Option

(Timing Register 0 TR0 = X X X X X 0 0 0)

The ADV7177/ADV7178 is controlled by the SAV (Start Active Video) and EAV (End Active Video) time codes in the pixel data. All timing information is transmitted using a 4-byte synchronization pattern. A synchronization pattern is sent immediately before and after each line during active picture and retrace. Mode 0 is illustrated in Figure 14. The $\overline{\text{HSYNC}}$, $\overline{\text{FIELD/VSYNC}}$ and $\overline{\text{BLANK}}$ (if not used) pins should be tied high during this mode.

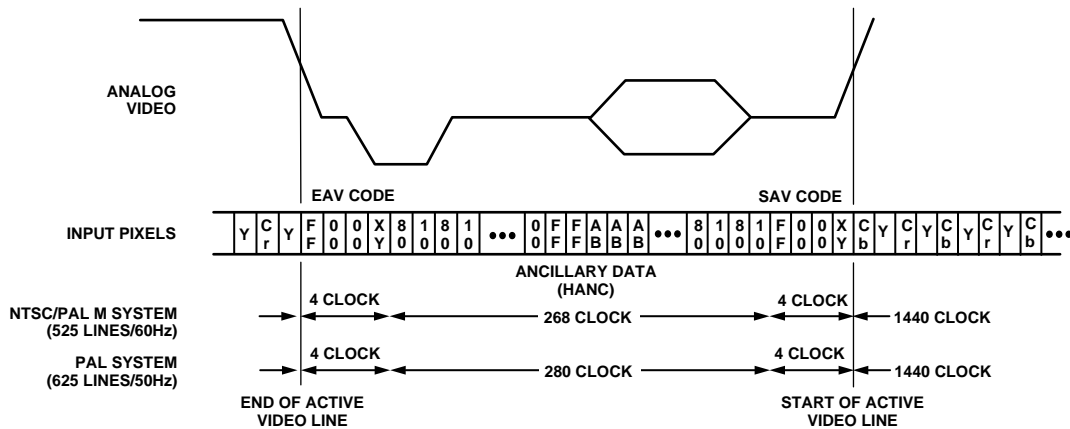

Figure 14. Timing Mode 0 (Slave Mode)

Mode 0 (CCIR-656): Master Option

(Timing Register 0 TR0 = X X X X X 0 0 1)

The ADV7177/ADV7178 generates H, V and F signals required for the SAV (Start Active Video) and EAV (End Active Video) time codes in the CCIR-656 standard. The H bit is output on the $\overline{\text{HSYNC}}$ pin, the V bit is output on the $\overline{\text{BLANK}}$ pin, and the F bit is output on the $\overline{\text{FIELD/VSYNC}}$ pin. Mode 0 is illustrated in Figure 15 (NTSC) and Figure 16 (PAL). The H, V and F transitions relative to the video waveform are illustrated in Figure 17.

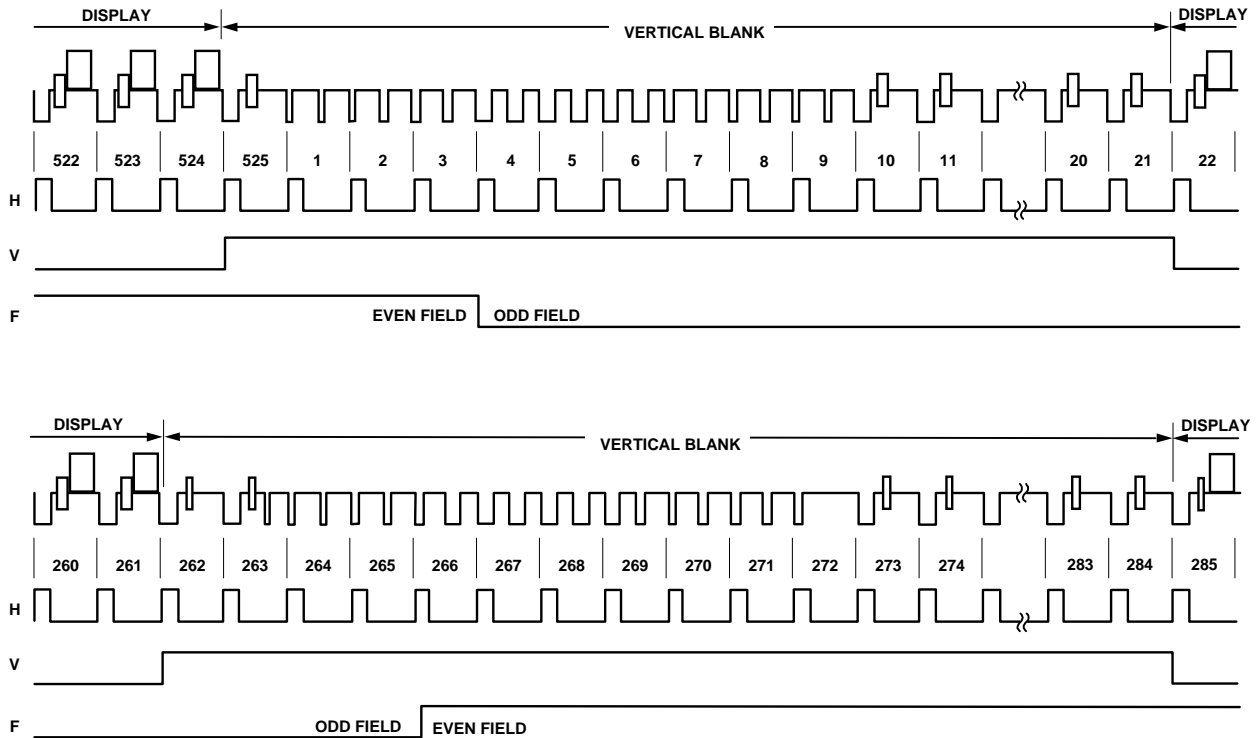

Figure 15. Timing Mode 0 (NTSC Master Mode)

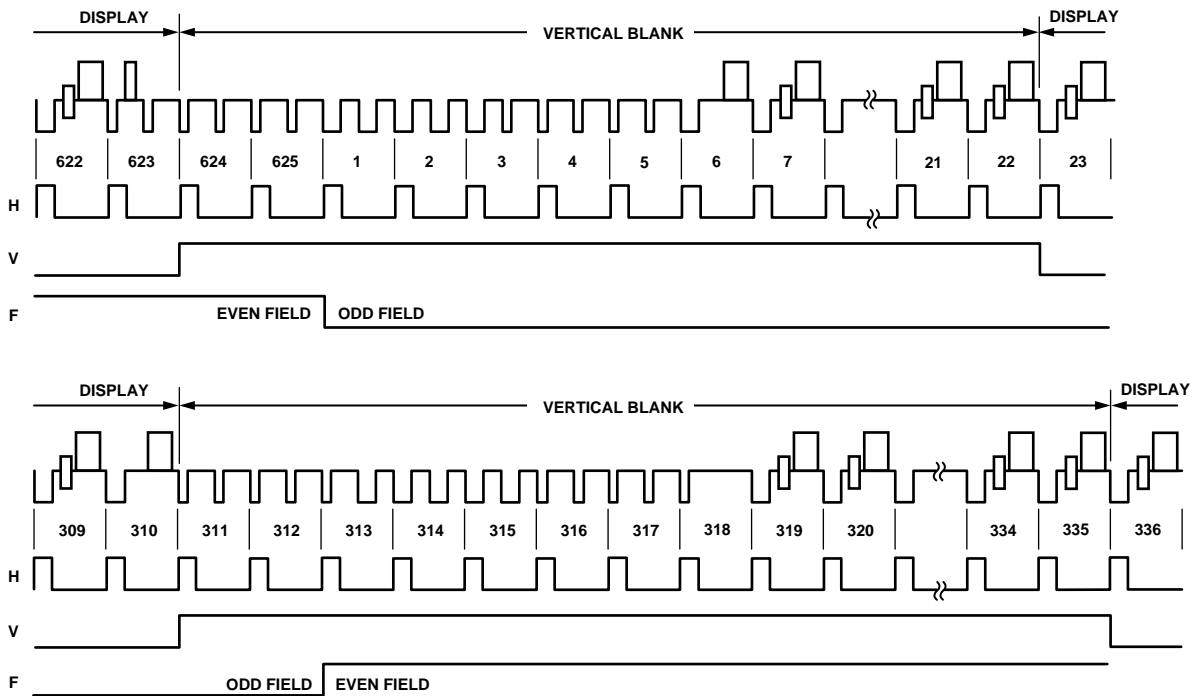

Figure 16. Timing Mode 0 (PAL Master Mode)

ADV7177/ADV7178

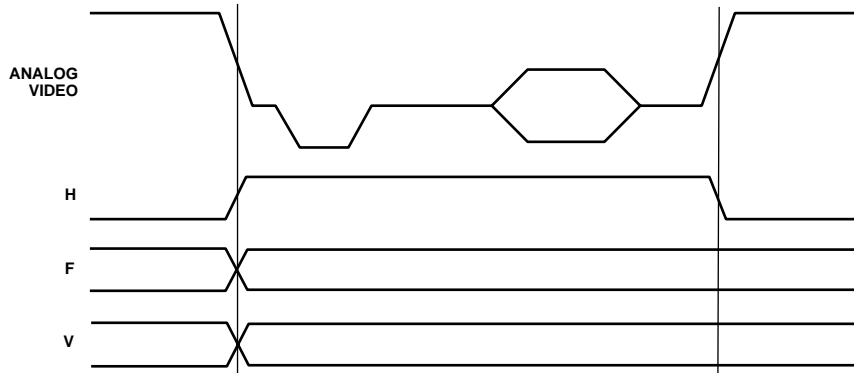

Figure 17. Timing Mode 0 Data Transitions (Master Mode)

Mode 1: Slave Option $\overline{\text{HSYNC}}$, $\overline{\text{BLANK}}$, FIELD (Timing Register 0 TR0 = X X X X X 0 1 0)

In this mode the ADV7177/ADV7178 accepts horizontal SYNC and Odd/Even FIELD signals. A transition of the FIELD input when $\overline{\text{HSYNC}}$ is low indicates a new frame, i.e., vertical retrace. The $\overline{\text{BLANK}}$ signal is optional. When the $\overline{\text{BLANK}}$ input is disabled, the ADV7177/ADV7178 automatically blanks all normally blank lines. Mode 1 is illustrated in Figure 18 (NTSC) and Figure 19 (PAL).

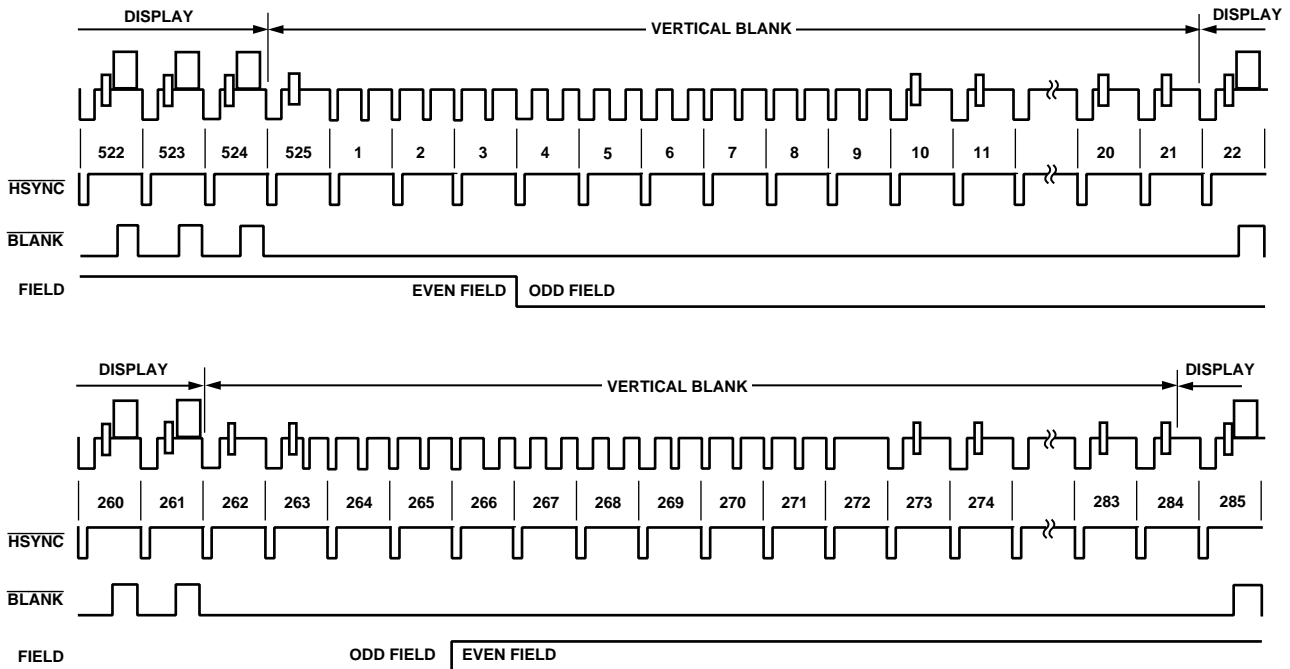

Figure 18. Timing Mode 1 (NTSC)

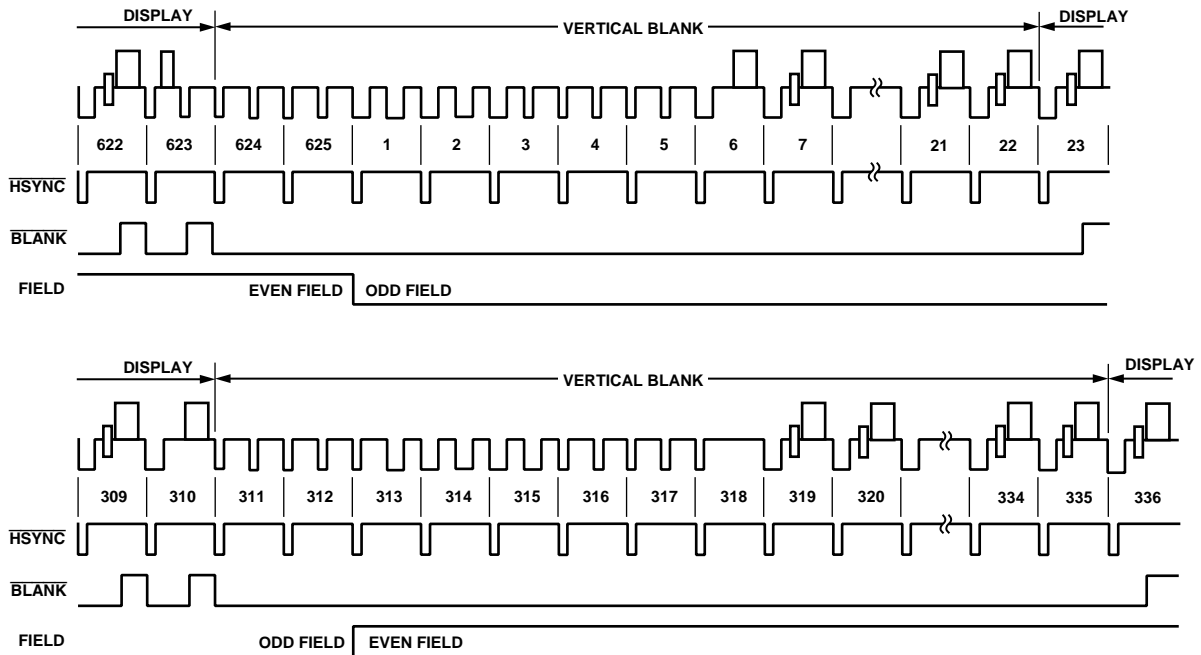

Figure 19. Timing Mode 1 (PAL)

Mode 1: Master Option $\overline{\text{HSYNC}}$, $\overline{\text{BLANK}}$, FIELD

(Timing Register 0 TR0 = X X X X X 0 1 1)

In this mode the ADV7177/ADV7178 can generate horizontal SYNC and Odd/Even FIELD signals. A transition of the FIELD input when $\overline{\text{HSYNC}}$ is low indicates a new frame, i.e., vertical retrace. The $\overline{\text{BLANK}}$ signal is optional. When the $\overline{\text{BLANK}}$ input is disabled, the ADV7177/ADV7178 automatically blanks all normally blank lines. Pixel data is latched on the rising clock edge following the timing signal transitions. Mode 1 is illustrated in Figure 18 (NTSC) and Figure 19 (PAL). Figure 20 illustrates the $\overline{\text{HSYNC}}$, $\overline{\text{BLANK}}$ and FIELD for an odd or even field transition relative to the pixel data.

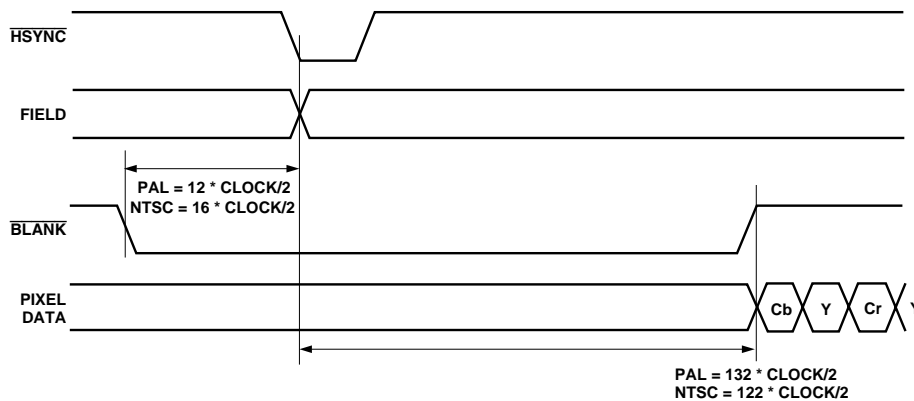

Figure 20. Timing Mode 1 Odd/Even Field Transitions Master/Slave

ADV7177/ADV7178

Mode 2: Slave Option $\overline{\text{HSYNC}}$, $\overline{\text{VSYNC}}$, $\overline{\text{BLANK}}$

(Timing Register 0 TR0 = X X X X X 1 0 0)

In this mode the ADV7177/ADV7178 accepts horizontal and vertical SYNC signals. A coincident low transition of both $\overline{\text{HSYNC}}$ and $\overline{\text{VSYNC}}$ inputs indicates the start of an odd field. A $\overline{\text{VSYNC}}$ low transition when $\overline{\text{HSYNC}}$ is high indicates the start of an even field. The $\overline{\text{BLANK}}$ signal is optional. When the $\overline{\text{BLANK}}$ input is disabled, the ADV7177/ADV7178 automatically blanks all normally blank lines as per CCIR-624. Mode 2 is illustrated in Figure 21 (NTSC) and Figure 22 (PAL).

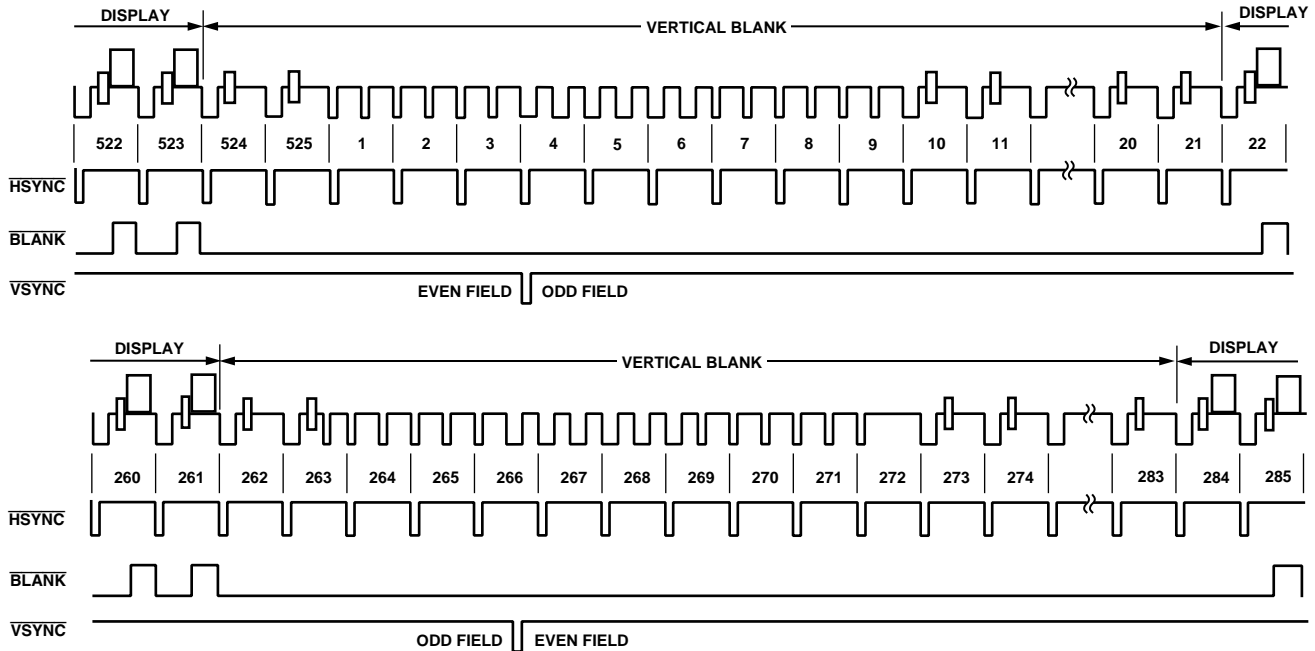

Figure 21. Timing Mode 2 (NTSC)

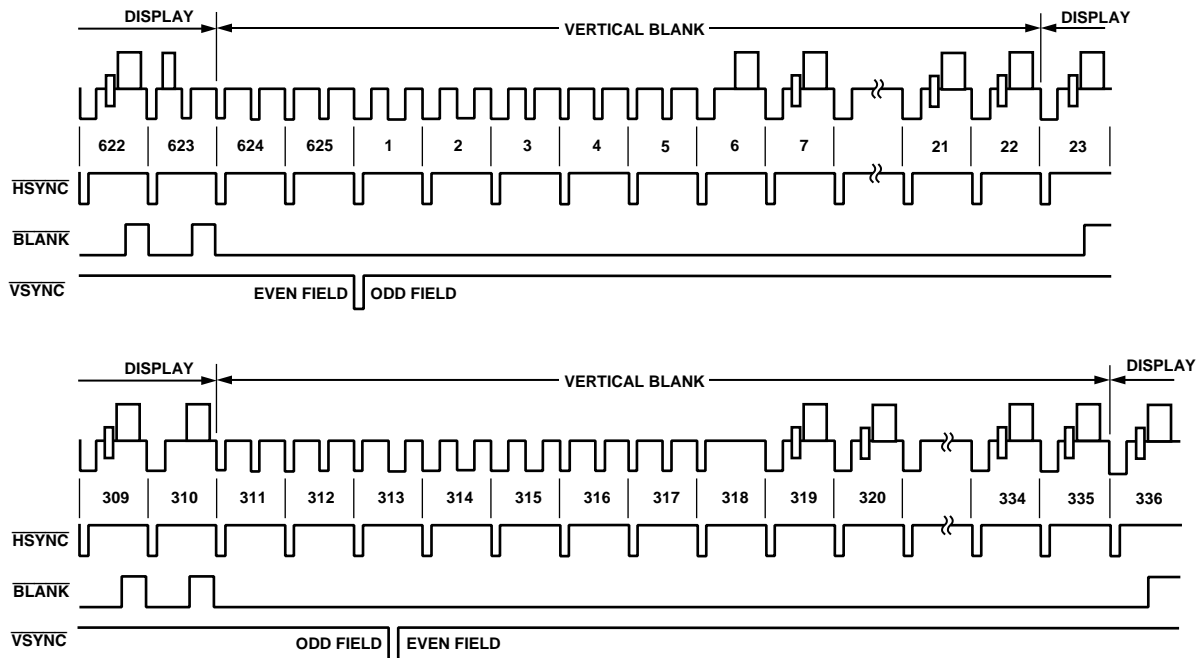

Figure 22. Timing Mode 2 (PAL)

Mode 2: Master Option $\overline{\text{HSYNC}}$, $\overline{\text{VSYNC}}$, $\overline{\text{BLANK}}$

(Timing Register 0 TR0 = X X X X X 1 0 1)

In this mode, the ADV7177/ADV7178 can generate horizontal and vertical SYNC signals. A coincident low transition of both $\overline{\text{HSYNC}}$ and $\overline{\text{VSYNC}}$ inputs indicates the start of an Odd Field. A $\overline{\text{VSYNC}}$ low transition when $\overline{\text{HSYNC}}$ is high indicates the start of an even field. The $\overline{\text{BLANK}}$ signal is optional. When the $\overline{\text{BLANK}}$ input is disabled, the ADV7177/ADV7178 automatically blanks all normally blank lines as per CCIR-624. Mode 2 is illustrated in Figure 21 (NTSC) and Figure 22 (PAL). Figure 23 illustrates the $\overline{\text{HSYNC}}$, $\overline{\text{BLANK}}$ and $\overline{\text{VSYNC}}$ for an even-to-odd field transition relative to the pixel data. Figure 24 illustrates the $\overline{\text{HSYNC}}$, $\overline{\text{BLANK}}$ and $\overline{\text{VSYNC}}$ for an odd-to-even field transition relative to the pixel data.

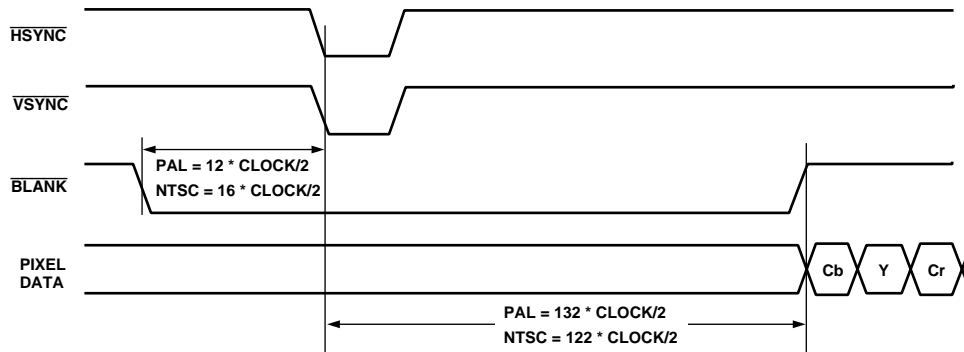

Figure 23. Timing Mode 2 Even-to-Odd Field Transition Master/Slave

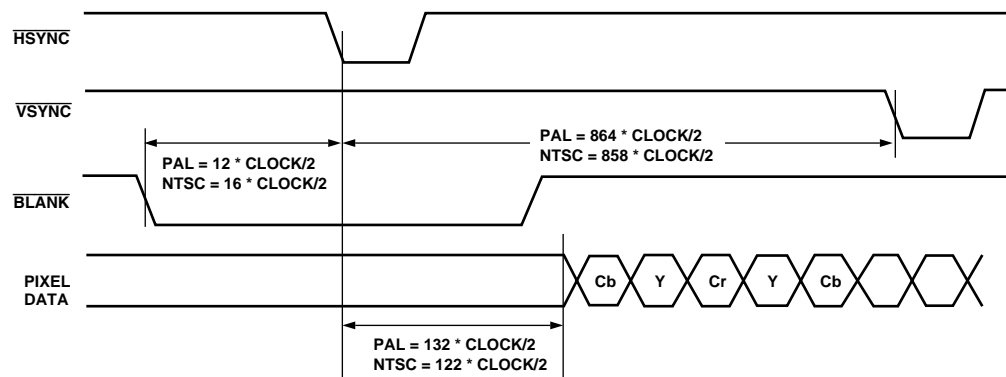

Figure 24. Timing Mode 2 Odd-to-Even Field Transition Master/Slave

ADV7177/ADV7178

Mode 3: Master/Slave Option $\overline{\text{HSYNC}}$, $\overline{\text{BLANK}}$, FIELD

(Timing Register 0 TR0 = X X X X X 1 1 0 or X X X X X 1 1 1)

In this mode, the ADV7177/ADV7178 accepts or generates Horizontal SYNC and Odd/Even FIELD signals. A transition of the FIELD input when $\overline{\text{HSYNC}}$ is high indicates a new frame, i.e., vertical retrace. The $\overline{\text{BLANK}}$ signal is optional. When the $\overline{\text{BLANK}}$ input is disabled, the ADV7177/ADV7178 automatically blanks all normally blank lines as per CCIR-624. Mode 3 is illustrated in Figure 25 (NTSC) and Figure 26 (PAL).

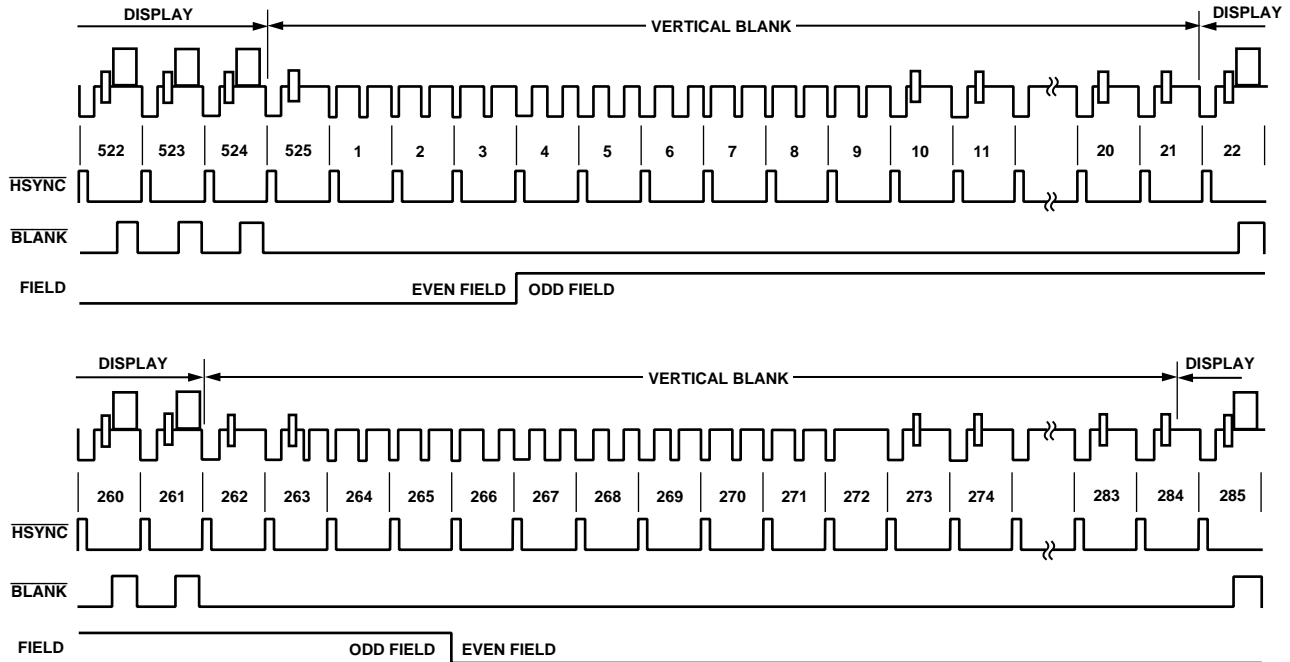

Figure 25. Timing Mode 3 (NTSC)

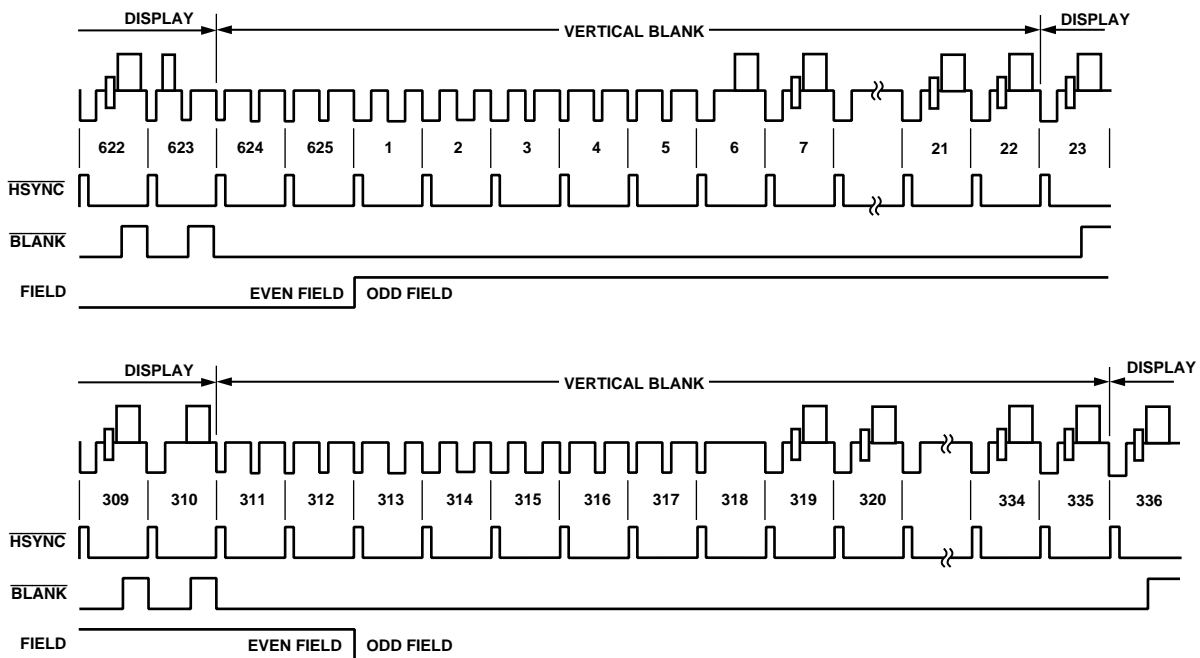

Figure 26. Timing Mode 3 (PAL)

OUTPUT VIDEO TIMING

The video timing generator generates the appropriate SYNC, $\overline{\text{BLANK}}$ and BURST sequence that controls the output analog waveforms. These sequences are summarized below. In slave modes, the following sequences are synchronized with the input timing control signals. In master modes, the timing generator free runs and generates the following sequences in addition to the output timing control signals.

NTSC-Interlaced: Scan Lines 1–9 and 264–272 are always blanked and vertical sync pulses are included. Scan Lines 525, 10–21 and 262, 263, 273–284 are also blanked and can be used for closed captioning data. Burst is disabled on lines 1–6, 261–269 and 523–525.

NTSC-Noninterlaced: Scan Lines 1–9 are always blanked, and vertical sync pulses are included. Scan Lines 10–21 are also blanked and can be used for closed captioning data. Burst is disabled on Lines 1–6, 261–262.

PAL-Interlaced: Scan Lines 1–6, 311–318 and 624–625 are always blanked, and vertical sync pulses are included in Fields 1, 2, 5 and 6. Scan Lines 1–5, 311–319 and 624–625 are always blanked, and vertical sync pulses are included in Fields 3, 4, 7 and 8. The remaining scan lines in the vertical blanking interval are also blanked and can be used for teletext data. Burst is disabled on Lines 1–6, 311–318 and 623–625 in Fields 1, 2, 5 and 6. Burst is disabled on Lines 1–5, 311–319 and 623–625 in Fields 3, 4, 7 and 8.

PAL-Noninterlaced: Scan Lines 1–6 and 311–312 are always blanked, and vertical sync pulses are included. The remaining scan lines in the vertical blanking interval are also blanked and can be used for teletext data. Burst is disabled on Lines 1–5, 310–312.

POWER-ON RESET

After power-up, it is necessary to execute a reset operation. A reset occurs on the falling edge of a high-to-low transition on the $\overline{\text{RESET}}$ pin. This initializes the pixel port so that the pixel inputs, P7–P0 are selected. After reset, the ADV7177/ADV7178 is automatically set up to operate in NTSC mode. Subcarrier frequency code 21F07C16HEX is loaded into the subcarrier frequency registers. All other registers, with the exception of Mode Register 0, are set to 00H. All bits in Mode Register 0 are set to Logic Level “0” except Bit MR02. Bit MR02 of Mode Register 0 is set to Logic Level “1.” This enables the 7.5 IRE pedestal.

SCH Phase Mode

The SCH phase is configured in default mode to reset every four (NTSC) or eight (PAL) fields to avoid an accumulation of SCH phase error over time. In an ideal system, zero SCH phase error would be maintained forever, but in reality, this is impossible to achieve due to clock frequency variations. This effect is reduced by the use of a 32-bit DDS, which generates this SCH.

Resetting the SCH phase every four or eight fields avoids the accumulation of SCH phase error, and results in very minor SCH phase jumps at the start of the four or eight field sequence.

Resetting the SCH phase should not be done if the video source does not have stable timing or the ADV7177/ADV7178 is configured in RTC mode (MR21 = 1 and MR22 = 1). Under these conditions (unstable video) the subcarrier phase reset should be enabled MR22 = 0 and MR21 = 1) but no reset applied. In

this configuration the SCH phase will never be reset, which means that the output video will now track the unstable input video. The subcarrier phase reset, when applied, will reset the SCH phase to Field 0 at the start of the next field (e.g., subcarrier phase reset applied in Field 5 [PAL] on the start of the next field SCH phase will be reset to Field 0).

MPU PORT DESCRIPTION

The ADV7178 and ADV7177 support a two-wire serial (I²C-Compatible) microprocessor bus driving multiple peripherals. Two inputs, serial data (SDATA) and serial clock (SCLOCK), carry information between any device connected to the bus. Each slave device is recognized by a unique address. The ADV7178 and ADV7177 each have four possible slave addresses for both read and write operations. These are unique addresses for each device and are illustrated in Figure 27 and Figure 28. The LSB sets either a read or write operation. Logic Level “1” corresponds to a read operation, while Logic Level “0” corresponds to a write operation. A1 is set by setting the ALSB pin of the ADV7177/ADV7178 to Logic Level “0” or Logic Level “1.”

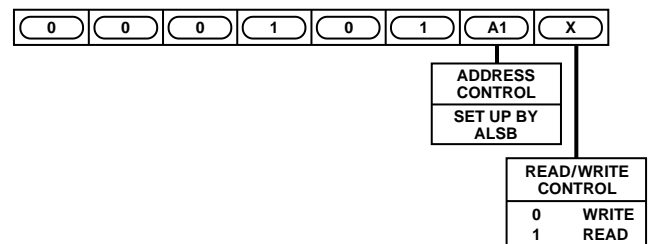

Figure 27. ADV7178 Slave Address

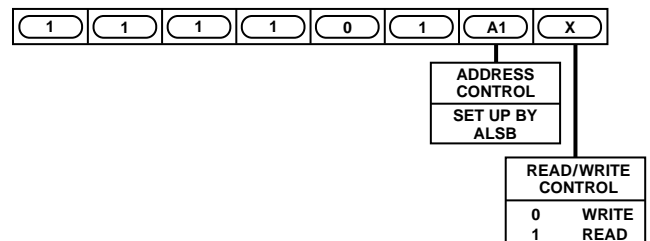

Figure 28. ADV7177 Slave Address

To control the various devices on the bus, the following protocol must be followed: First, the master initiates a data transfer by establishing a start condition, defined by a high-to-low transition on SDATA while SCLOCK remains high. This indicates that an address/data stream will follow. All peripherals respond to the start condition and shift the next eight bits (7-bit address + $\overline{\text{R/W}}$ bit). The bits transfer from MSB down to LSB. The peripheral that recognizes the transmitted address responds by pulling the data line low during the ninth clock pulse. This is known as an acknowledge bit. All other devices withdraw from the bus at this point and maintain an idle condition. The idle condition is where the device monitors the SDATA and SCLOCK lines waiting for the start condition and the correct transmitted address. The $\overline{\text{R/W}}$ bit determines the direction of the data. A Logic “0” on the LSB of the first byte means that the master will write information to the peripheral. A Logic “1” on the LSB of the first byte means that the master will read information from the peripheral.

ADV7177/ADV7178

The ADV7177/ADV7178 acts as a standard slave device on the bus. The data on the SDATA pin is 8 bits long, supporting the 7-bit addresses, plus the R/W bit. The ADV7178 has 36 subaddresses and the ADV7177 has 31 subaddresses to enable access to the internal registers. It therefore interprets the first byte as the device address and the second byte as the starting subaddress. The subaddresses auto increment allows data to be written to or read from the starting subaddress. A data transfer is always terminated by a stop condition. The user can also access any unique subaddress register on a one-by-one basis without having to update all the registers. There is one exception. The subcarrier frequency registers should be updated in sequence, starting with Subcarrier Frequency Register 0. The auto increment function should then be used to increment and access Subcarrier Frequency Registers 1, 2 and 3. The subcarrier frequency registers should not be accessed independently.

Stop and start conditions can be detected at any stage during the data transfer. If these conditions are asserted out of sequence with normal read and write operations, they cause an immediate jump to the idle condition. During a given SCLOCK high period, the user should issue only one start condition, one stop condition or a single stop condition followed by a single start condition. If an invalid subaddress is issued by the user, the ADV7177/ADV7178 will not issue an acknowledge and will return to the idle condition. If, in auto-increment mode, the user exceeds the highest subaddress, the following action will be taken:

1. In Read Mode, the highest subaddress register contents will continue to be output until the master device issues a no-acknowledge. This indicates the end of a read. A no-acknowledge condition is where the SDATA line is not pulled low on the ninth pulse.

2. In Write Mode, the data for the invalid byte will not be loaded into any subaddress register, a no-acknowledge will be issued by the ADV7177/ADV7178 and the part will return to the idle condition.

Figure 29 illustrates an example of data transfer for a read sequence and the start and stop conditions.

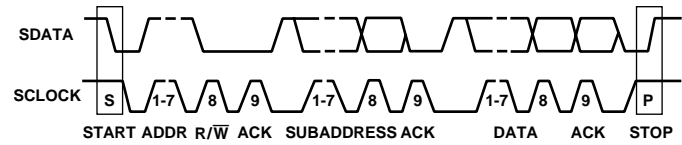

Figure 29. Bus Data Transfer

Figure 30 shows bus write and read sequences.

REGISTER ACCESSES

The MPU can write to or read from all of the ADV7177/ADV7178 registers except the subaddress register, which is a write-only register. The subaddress register determines which register the next read or write operation accesses. All communications with the part through the bus start with an access to the subaddress register. A read/write operation is performed from/to the target address, which then increments to the next address until a stop command on the bus is performed.

REGISTER PROGRAMMING

The following section describes each register, including subaddress register, mode registers, subcarrier frequency registers, subcarrier phase register, timing registers, closed captioning extended data registers, closed captioning data registers and NTSC pedestal control registers in terms of its configuration.

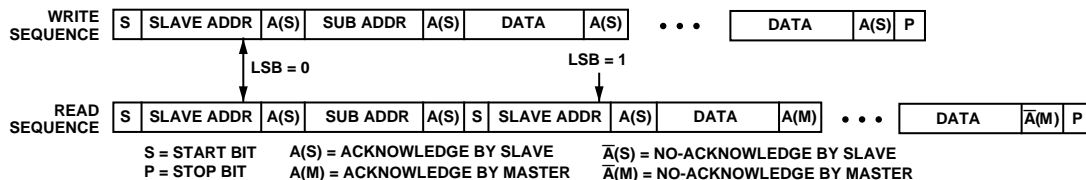

Figure 30. Write and Read Sequences

Subaddress Register (SR7–SR0)

The communications register is an 8-bit write-only register. After the part has been accessed over the bus, and a read/write operation is selected, the subaddress is set up. The subaddress register determines to/from which register the operation takes place.

Figure 31 shows the various operations under the control of the subaddress register. Zero should always be written to SR7–SR6.

Register Select (SR5–SR0)

These bits are set up to point to the required starting address.

MODE REGISTER 0 MR0 (MR07–MR00)

(Address [SR4–SR0] = 00H)

Figure 32 shows the various operations under the control of Mode Register 0. This register can be read from as well as written to.

MR0 BIT DESCRIPTION

Encode Mode Control (MR01–MR00)

These bits are used to set up the encode mode. The ADV7177/ADV7178 can be set up to output NTSC, PAL (B, D, G, H, I) and PAL (M) standard video.

Pedestal Control (MR02)

This bit specifies whether a pedestal is to be generated on the NTSC composite video signal. This bit is invalid if the ADV7177/ADV7178 is configured in PAL mode.

Luminance Filter Control (MR04–MR03)

The luminance filters are divided into two sets (NTSC/PAL) of four filters, low-pass A, low-pass B, notch and extended. When PAL is selected, bits MR03 and MR04 select one of four PAL luminance filters; likewise, when NTSC is selected, bits MR03 and MR04 select one of four NTSC luminance filters. The filters are illustrated in Figures 7 to 13.

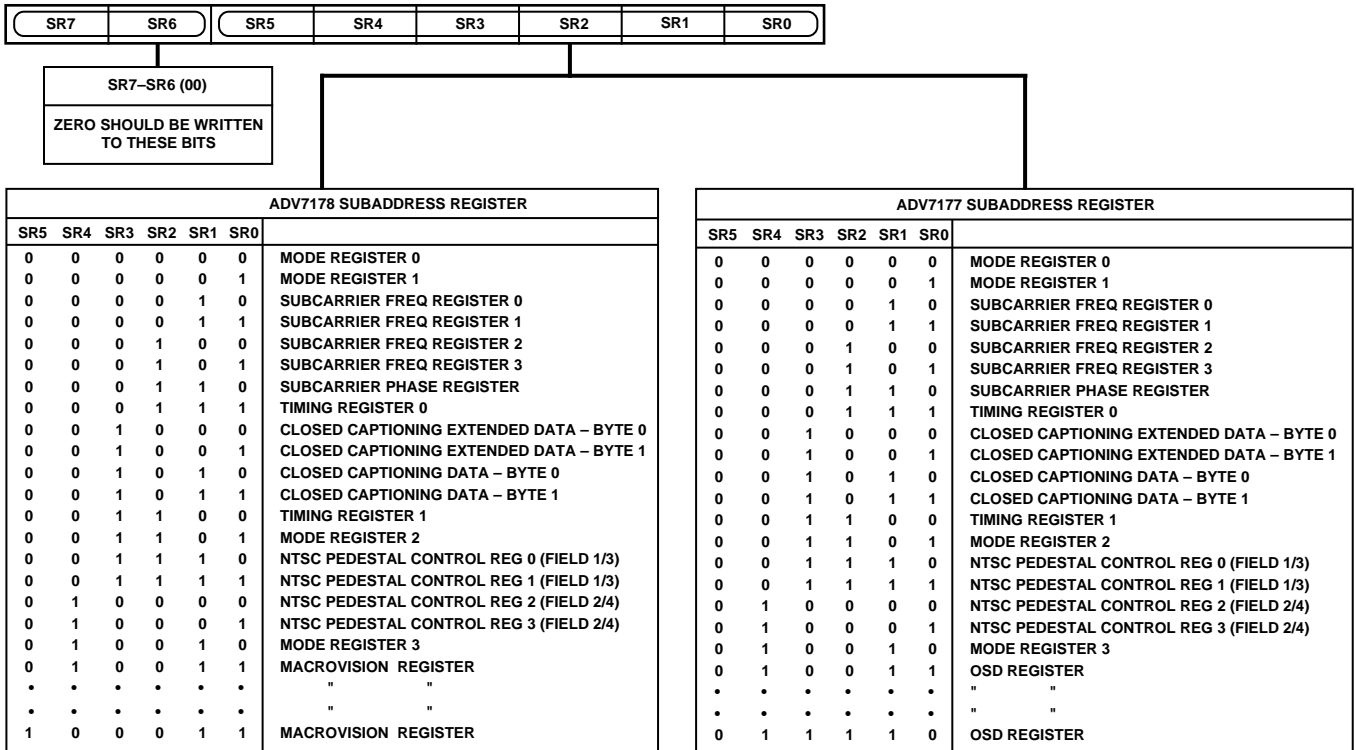

Figure 31. Subaddress Register

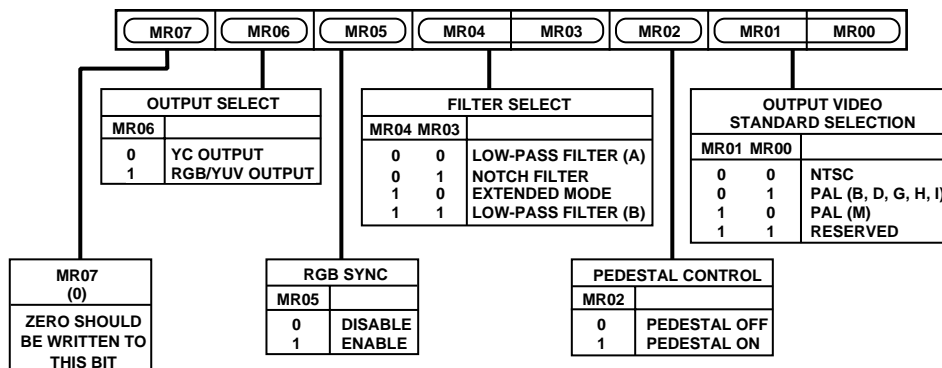

Figure 32. Mode Register 0 (MR0)

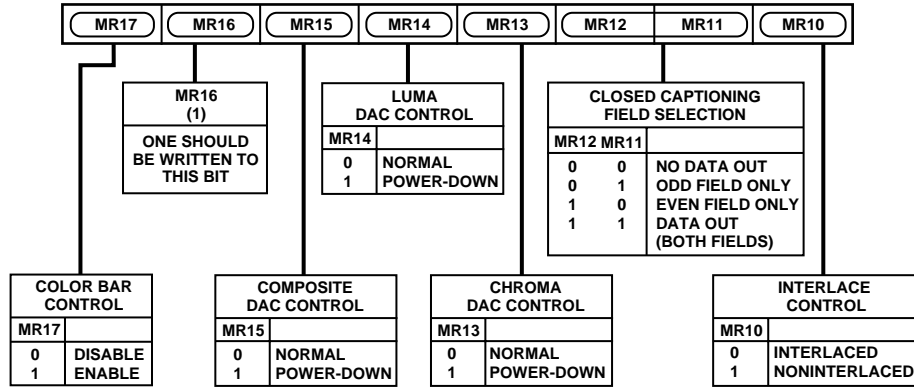

Figure 33. Mode Register 1 (MR1)

RGB Sync (MR05)

This bit is used to set up the RGB outputs with the sync information encoded on all RGB outputs.

Output Control (MR06)

This bit specifies if the part is in composite video or RGB/YUV mode. Please note that the main composite signal is still available in RGB/YUV mode.

MODE REGISTER 1 MR1 (MR17–MR10)

(Address (SR4–SR0) = 01H)

Figure 33 shows the various operations under the control of Mode Register 1. This register can be read from as well as written to.

MR1 BIT DESCRIPTION

Interlaced Mode Control (MR10)

This bit is used to set up the output to interlaced or noninterlaced mode. This mode is only relevant when the part is in composite video mode.

Closed Captioning Field Control (MR12–MR11)

These bits control the fields on which closed captioning data is displayed; closed captioning information can be displayed on an odd field, even field or both fields.

DAC Control (MR15–MR13)

These bits can be used to power down the DACs. This can be used to reduce the power consumption of the ADV7177/ADV7178 if any of the DACs are not required in the application.

Color Bar Control (MR17)

This bit can be used to generate and output an internal color bar test pattern. The color bar configuration is 75/7.5/75/7.5 for NTSC and 100/0/75/0 for PAL. It is important to note that when color bars are enabled the ADV7177/ADV7178 is configured in a master timing mode as per the one selected by bits TR01 and TR02.

SUBCARRIER FREQUENCY REGISTER 3-0

(FSC3–FSC0)

(Address [SR4–SR0] = 05H–02H)

These 8-bit-wide registers are used to set up the subcarrier frequency. The value of these registers are calculated by using the following equation:

$$\text{Subcarrier Frequency Register} = \frac{2^{32} - 1}{F_{CLK}} \times F_{SCF}$$

i.e.: NTSC Mode,

$$F_{CLK} = 27 \text{ MHz},$$

$$F_{SCF} = 3.5795454 \text{ MHz}$$

$$\begin{aligned} \text{Subcarrier Frequency Value} &= \frac{2^{32} - 1}{27 \times 10^6} \times 3.5795454 \times 10^6 \\ &= 21F07C16 \text{ HEX} \end{aligned}$$

Figure 34 shows how the frequency is set up by the four registers.

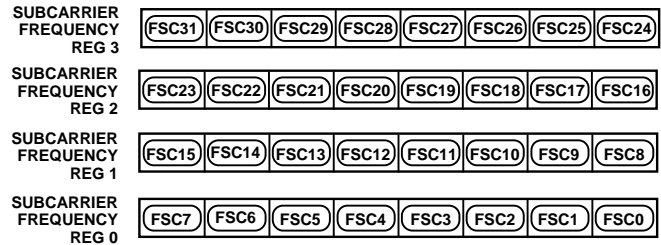

Figure 34. Subcarrier Frequency Register

SUBCARRIER PHASE REGISTER (FP7–FP0)

(Address [SR4–SR0] = 06H)

This 8-bit-wide register is used to set up the subcarrier phase. Each bit represents 1.41 degrees.

TIMING REGISTER 0 (TR07–TR00)

(Address [SR4–SR0] = 07H)

Figure 35 shows the various operations under the control of Timing Register 0. This register can be read from as well as written to. This register can be used to adjust the width and position of the master mode timing signals.

TR0 BIT DESCRIPTION

Master/Slave Control (TR00)

This bit controls whether the ADV7177/ADV7178 is in master or slave mode. This register can be used to adjust the width and position of the master timing signals.

Timing Mode Control (TR02–TR01)

These bits control the timing mode of the ADV7177/ADV7178. These modes are described in the Timing and Control section of the data sheet.

BLANK Control (TR03)

This bit controls whether the $\overline{\text{BLANK}}$ input is used when the part is in slave mode

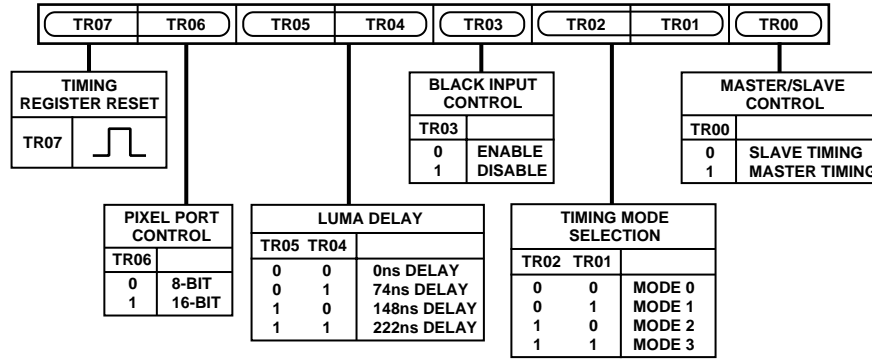

Figure 35. Timing Register 0

Luma Delay Control (TR05–TR04)

These bits control the addition of a luminance delay. Each bit represents a delay of 74 ns.

Pixel Port Select (TR06)

This bit is used to set the pixel port to accept 8-bit or 16-bit data. If an 8-bit input is selected the data will be set up on Pins P7–P0.

Timing Register Reset (TR07)

Toggling TR07 from low to high and low again resets the internal timing counters. This bit should be toggled after power-up, reset or changing to a new timing mode.

CLOSED CAPTIONING EVEN FIELD DATA REGISTER 1–0 (CED15–CED00)
(Address [SR4–SR0] = 09–08H)

These 8-bit-wide registers are used to set up the closed captioning extended data bytes on even fields. Figure 36 shows how the high and low bytes are set up in the registers.

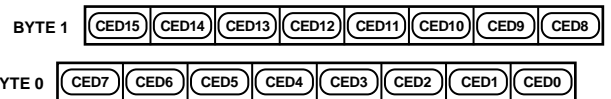

Figure 36. Closed Captioning Extended Data Register

CLOSED CAPTIONING ODD FIELD DATA REGISTER 1–0 (CCD15–CCD00)
(Subaddress [SR4–SR0] = 0B–0AH)

These 8-bit-wide registers are used to set up the closed captioning data bytes on odd fields. Figure 37 shows how the high and low bytes are set up in the registers.



Figure 37. Closed Captioning Data Register

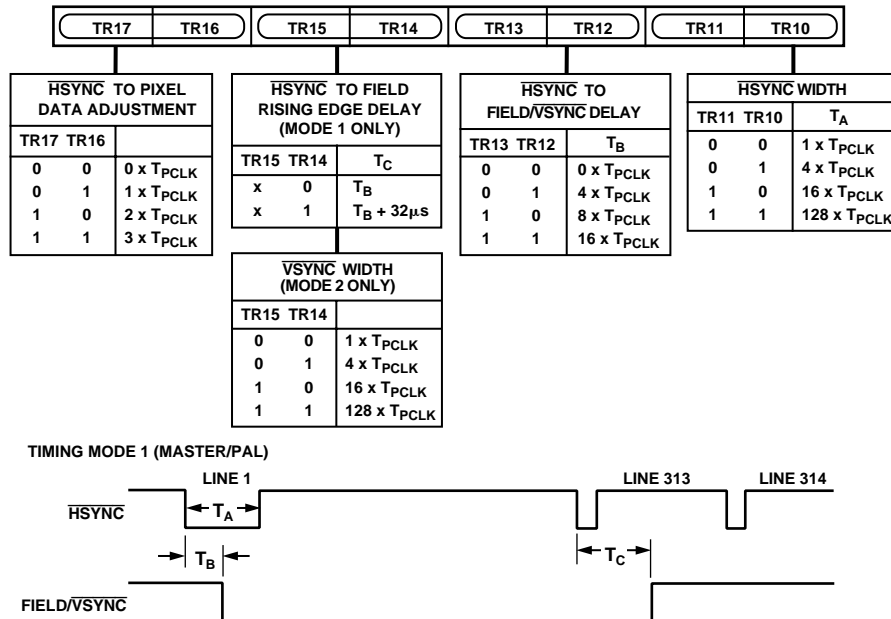

Figure 38. Timing Register 1

ADV7177/ADV7178

TIMING REGISTER 1 (TR17–TR10)

(Address [SR4–SR0] = 0CH)

Timing Register 1 is an 8-bit-wide register.

Figure 38 shows the various operations under the control of Timing Register 1. This register can be read from as well as written to. This register can be used to adjust the width and position of the master mode timing signals.

TR1 BIT DESCRIPTION

$\overline{\text{HSYNC}}$ Width (TR11–TR10)

These bits adjust the $\overline{\text{HSYNC}}$ pulsewidth.

$\overline{\text{HSYNC}}$ to $\overline{\text{VSYNC}}$ /FIELD Delay Control (TR13–TR12)

These bits adjust the position of the $\overline{\text{HSYNC}}$ output relative to the FIELD/ $\overline{\text{VSYNC}}$ output.

$\overline{\text{HSYNC}}$ to FIELD Delay Control (TR15–TR14)

When the ADV7177/ADV7178 is in Timing Mode 1, these bits adjust the position of the $\overline{\text{HSYNC}}$ output relative to the FIELD output rising edge.

$\overline{\text{VSYNC}}$ Width (TR15–TR14)

When the ADV7177/ADV7178 is in Timing Mode 2, these bits adjust the $\overline{\text{VSYNC}}$ pulsewidth.

$\overline{\text{HSYNC}}$ to Pixel Data Adjust (TR17–TR16)

This enables the $\overline{\text{HSYNC}}$ to be adjusted with respect to the pixel data. This allows the Cr and Cb components to be swapped. This adjustment is available in both master and slave timing modes.

MODE REGISTER 2 MR2 (MR27–MR20)

(Address [SR4–SR0] = 0DH)

Mode Register 2 is an 8-bit-wide register.

Figure 39 shows the various operations under the control of Mode Register 2. This register can be read from as well as written to.

MR2 BIT DESCRIPTION

Square Pixel Mode Control (MR20)

This bit is used to set up square pixel mode. This is available in slave mode only. For NTSC, a 24.54 MHz clock must be supplied. For PAL, a 29.5 MHz clock must be supplied.

Active Video Line Control (MR23)

This bit switches between two active video line durations. A zero selects ITU-R BT.470 (720 pixels PAL/NTSC) and a one selects ITU-R/SMPTE “analog” standard for active video duration (710 pixels NTSC 702 pixels PAL).

Chrominance Control (MR24)

This bit enables the color information to be switched on and off the video output.

Burst Control (MR25)

This bit enables the burst information to be switched on and off the video output.

RGB/YUV Control (MR26)

This bit enables the output from the RGB DACs to be set to YUV output video standard. Bit MR06 of Mode Register 0 must be set to Logic Level “1” before MR26 is set.

Table II. DAC Output Configuration Matrix

| MR06 | MR26 | DAC A | DAC B | DAC C |
|------|------|-------|-------|-------|
| 0 | 0 | CVBS | Y | C |
| 0 | 1 | CVBS | Y | C |
| 1 | 0 | B | S | R |
| 1 | 1 | U | Y | V |

CVBS: Composite Video Baseband Signal

Y: Luminance Component Signal (For YUV or Y/C Mode)

C: Chrominance Signal (For Y/C Mode)

U: Chrominance Component Signal (For YUV Mode)

V: Chrominance Component Signal (For YUV Mode)

R: RED Component Video (For RGB Mode)

G: GREEN Component Video (For RGB Mode)

B: BLUE Component Video (For RGB Mode)

Low Power Control (MR27)

This bit enables the lower power mode of the ADV7177/ADV7178. This will reduce DAC current by 50%.

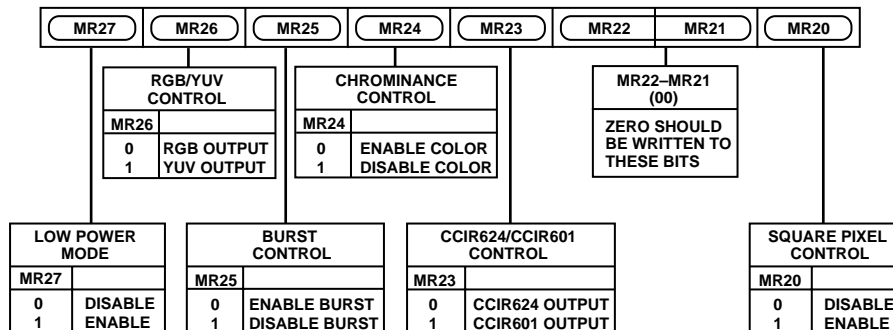

Figure 39. Mode Register 2

NTSC PEDESTAL REGISTERS 3-0 (PCE15-0, PCO15-0)
(Subaddress [SR4-SR0] = 11-0EH)

These 8-bit-wide registers are used to set up the NTSC pedestal on a line-by-line basis in the vertical blanking interval for both odd and even fields. Figure 40 show the four control registers. A Logic “1” in any of the bits of these registers has the effect of turning the pedestal OFF on the equivalent line when used in NTSC.

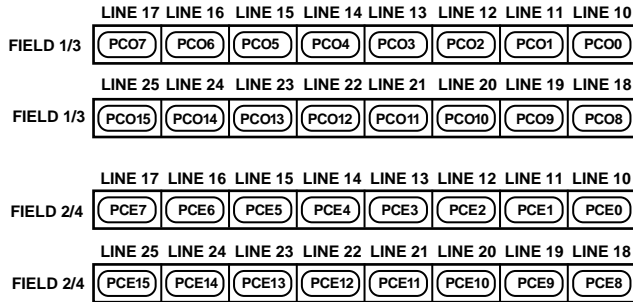

Figure 40. Pedestal Control Registers

MODE REGISTER 3 MR3 (MR37-MR30)
(Address [SR4-SR0] = 12H)

Mode Register 3 is an 8-bit-wide register. Figure 41 shows the various operations under the control of Mode Register 3.

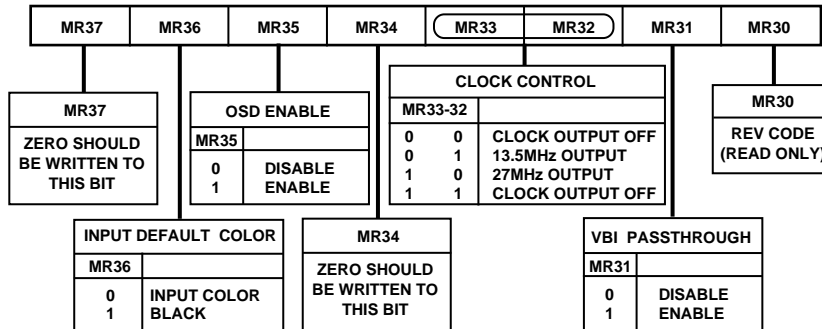

Figure 41. Mode Register 3

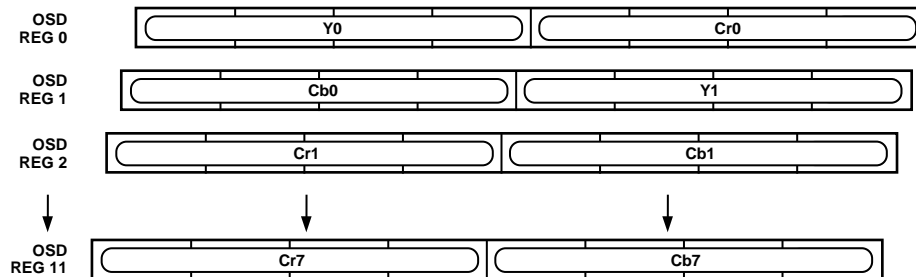

Figure 42. OSD Registers

MR3 BIT DESCRIPTION

Revision Code (MR30)

This bit is read only and indicates the revision of the device.

VBI Pass-Through Control (MR31)

This bit determines whether or not data in the vertical blanking interval (VBI) is output to the analog outputs or blanked.

Clock Output Select (MR33-MR32)

These bits control the synchronous clock output signal. The clock can be 27 MHz, 13.5 MHz or disabled, depending on the values of these bits.

OSD Enable (MR35)

A logic one in MR35 will enable the OSD function on the ADV7177.

Reserved (MR36)

These bits are reserved.

Input Default Color (MR36)

This bit determines the default output color from the DACs for zero input data (or disconnected). A Logical “0” means that the color corresponding to 00000000 will be displayed. A Logical “1” forces the output color to black for 00000000 input video data.

OSD REGISTER 0-11

(Address [SR4-SR0] = 12H-1DH)

There are 12 OSD registers as shown in Figure 42. There are four bits for each Y, Cb and Cr value, there are four zero added to give the complete byte for each value loaded internally. (Y0 = [Y0₃, Y0₂, Y0₁, Y0₀, 0, 0, 0, 0], Cb = [Cb₃, Cb₂, Cb₁, Cb₀, 0, 0, 0, 0], Cr = [Cr₃, Cr₂, Cr₁, Cr₀, 0, 0, 0, 0].)

BOARD DESIGN AND LAYOUT CONSIDERATIONS

The ADV7177/ADV7178 is a highly integrated circuit containing both precision analog and high speed digital circuitry. It has been designed to minimize interference effects on the integrity of the analog circuitry by the high speed digital circuitry. It is imperative that these same design and layout techniques be applied to the system level design so that high speed, accurate performance is achieved. The “Recommended Analog Circuit Layout” shows the analog interface between the device and monitor.

The layout should be optimized for lowest noise on the ADV7177/ADV7178 power and ground lines by shielding the digital inputs and providing good decoupling. The lead length between groups of V_{AA} and GND pins should be minimized to minimize inductive ringing.

Ground Planes

The ground plane should encompass all ADV7177/ADV7178 ground pins, voltage reference circuitry, power supply bypass circuitry for the ADV7177/ADV7178, the analog output traces, and all the digital signal traces leading up to the ADV7177/ADV7178. The ground plane is the board’s common ground plane.

This should be as substantial as possible to maximize heat spreading and power dissipation on the board.

Power Planes

The ADV7177/ADV7178 and any associated analog circuitry should have its own power plane, referred to as the analog power plane (V_{AA}). This power plane should be connected to the regular PCB power plane (V_{CC}) at a single point through a ferrite bead. This bead should be located within three inches of the ADV7177/ADV7178.

The metallization gap separating device power plane and board power plane should be as narrow as possible to minimize the obstruction to the flow of heat from the device into the general board.

The PCB power plane should provide power to all digital logic on the PC board, and the analog power plane should provide power to all ADV7177/ADV7178 power pins and voltage reference circuitry.

Plane-to-plane noise coupling can be reduced by ensuring that portions of the regular PCB power and ground planes do not overlay portions of the analog power plane unless they can be arranged so that the plane-to-plane noise is common-mode.

Supply Decoupling

For optimum performance, bypass capacitors should be installed using the shortest leads possible, consistent with reliable operation, to reduce the lead inductance. Best performance is obtained with 0.1 μ F ceramic capacitor decoupling. Each group of V_{AA} pins on the ADV7177/ADV7178 must have at least one 0.1 μ F decoupling capacitor to GND. These capacitors should be placed as close to the device as possible.

It is important to note that while the ADV7177/ADV7178 contains circuitry to reject power supply noise, this rejection decreases with frequency. If a high frequency switching power supply is used, the designer should pay close attention to reducing power supply noise and consider using a three terminal voltage regulator for supplying power to the analog power plane.

Digital Signal Interconnect

The digital inputs to the ADV7177/ADV7178 should be isolated as much as possible from the analog outputs and other analog circuitry. Also, these input signals should not overlay the analog power plane.

Due to the high clock rates involved, long clock lines to the ADV7177/ADV7178 should be avoided to reduce noise pickup.

Any active termination resistors for the digital inputs should be connected to the regular PCB power plane (V_{CC}) and not the analog power plane.

Analog Signal Interconnect

The ADV7177/ADV7178 should be located as close to the output connectors as possible to minimize noise pickup and reflections due to impedance mismatch.

The video output signals should overlay the ground plane, not the analog power plane, to maximize the high frequency power supply rejection.

Digital inputs, especially pixel data inputs and clocking signals, should never overlay any of the analog signal circuitry and should be kept as far away as possible.

For best performance, the outputs should each have a 75 Ω load resistor connected to GND. These resistors should be placed as close as possible to the ADV7177/ADV7178 as to minimize reflections.

The ADV7177/ADV7178 should have no inputs left floating. Any inputs that are not required should be tied to ground.

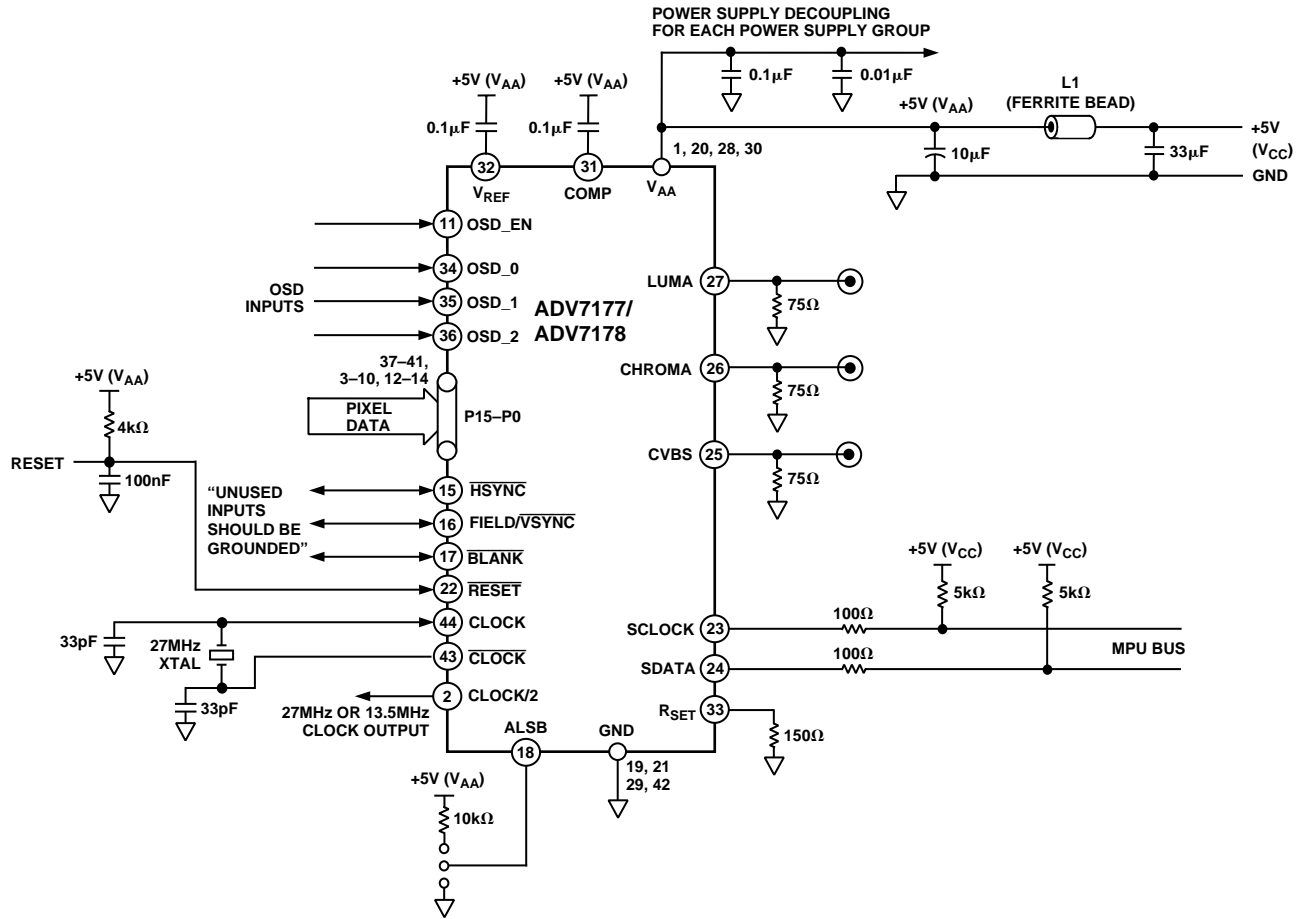

Figure 43. Recommended Analog Circuit Layout

APPENDIX 2

CLOSED CAPTIONING

The ADV7177/ADV7178 supports closed captioning, conforming to the standard television synchronizing waveform for color transmission. Closed captioning is transmitted during the blanked active line time of Line 21 of the odd fields and Line 284 of even fields.

Closed captioning consists of a 7-cycle sinusoidal burst that is frequency and phase locked to the caption data. After the clock run-in signal, the blanking level is held for two data bits and is followed by a Logic Level “1” start bit. 16 bits of data follow the start bit. These consist of two 8-bit bytes, seven data bits and one odd parity bit. The data for these bytes is stored in closed captioning Data Registers 0 and 1.

The ADV7177/ADV7178 also supports the extended closed captioning operation, which is active during even fields, and is encoded on scan Line 284. The data for this operation is stored in closed captioning extended Data Registers 0 and 1.

All clock run-in signals and timing to support closed captioning on Lines 21 and 284 are generated automatically by the ADV7177/ADV7178. All pixels inputs are ignored during Lines 21 and 284.

FCC Code of Federal Regulations (CFR) 47 Section 15.119 and EIA608 describe the closed captioning information for Lines 21 and 284.

The ADV7177/ADV7178 uses a single buffering method. This means that the closed captioning buffer is only one byte deep, therefore there will be no frame delay in outputting the closed captioning data unlike other 2-byte deep buffering systems. The data must be loaded at least one line before (Line 20 or Line 283) it is outputted on Line 21 and Line 284. A typical implementation of this method is to use $\overline{\text{VSYNC}}$ to interrupt a micro-processor, which will in turn load the new data (two bytes) every field. If no new data is required for transmission you must insert zeros in both the data registers; this is called NULLING. It is also important to load “control codes,” all of which are double bytes on Line 21, or a TV will not recognize them. If you have a message like “Hello World,” which has an odd number of characters, it is important to pad it out to an even number to get “end of caption” 2-byte control code to land in the same field.

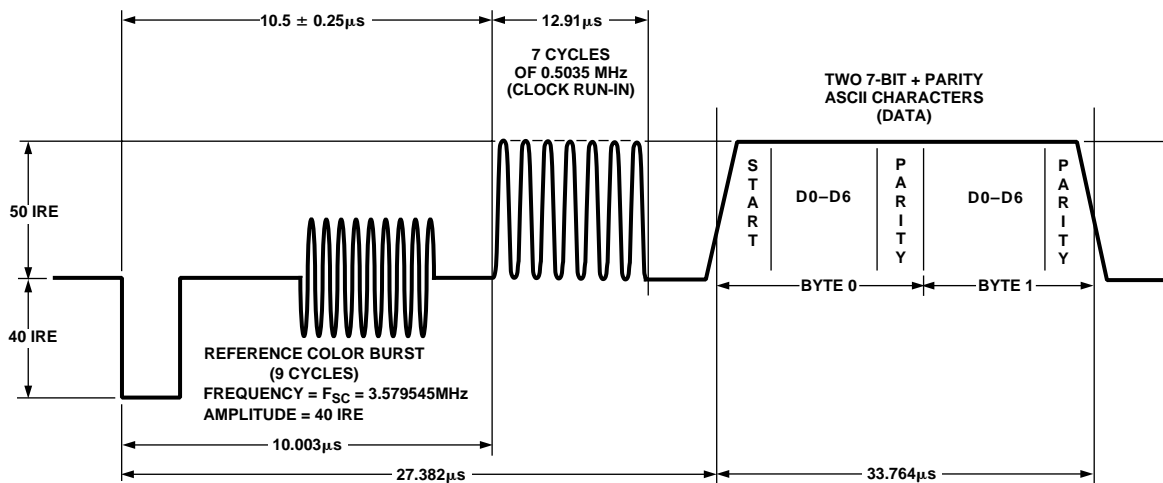

Figure 44. Closed Captioning Waveform (NTSC)

APPENDIX 3

NTSC WAVEFORMS (WITH PEDESTAL)

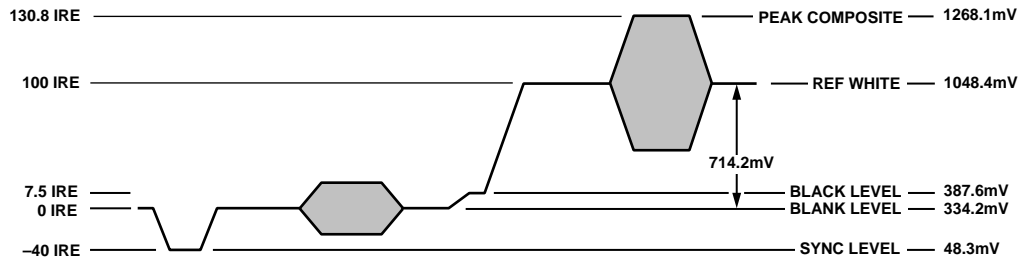

Figure 45. NTSC Composite Video Levels

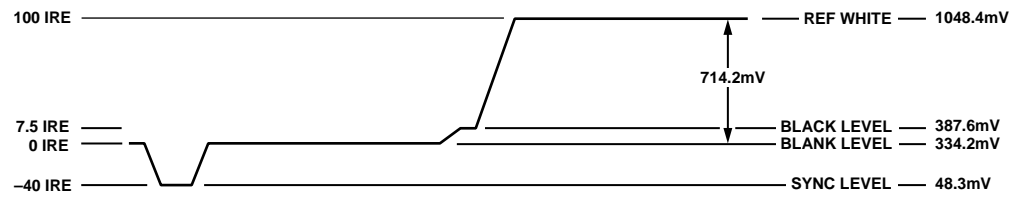

Figure 46. NTSC Luma Video Levels

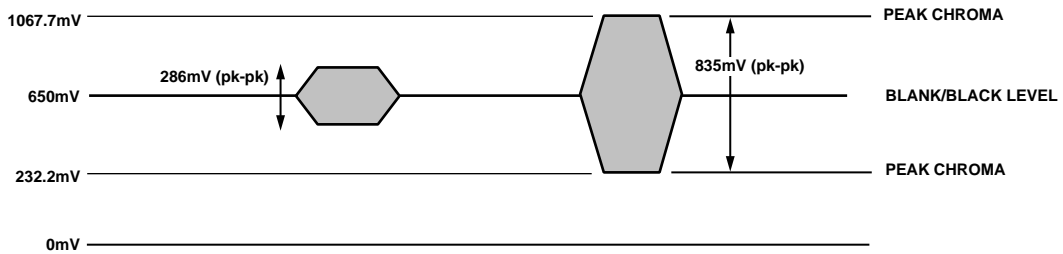

Figure 47. NTSC Chroma Video Levels

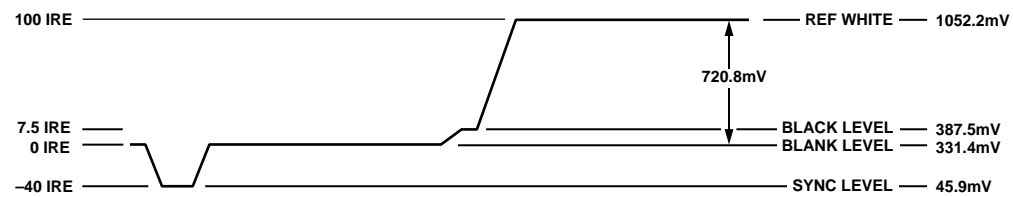

Figure 48. NTSC RGB Video Levels

NTSC WAVEFORMS (WITHOUT PEDESTAL)

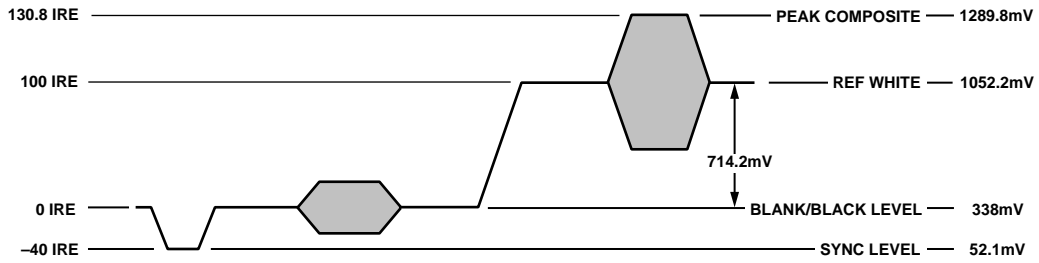

Figure 49. NTSC Composite Video Levels

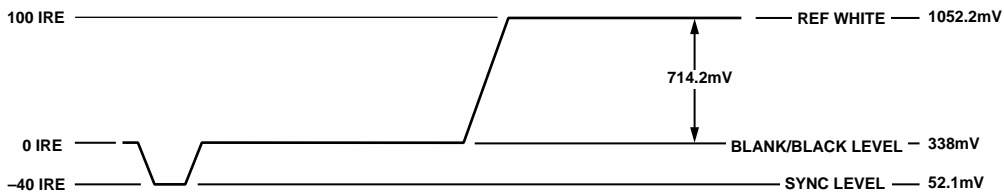

Figure 50. NTSC Luma Video Levels

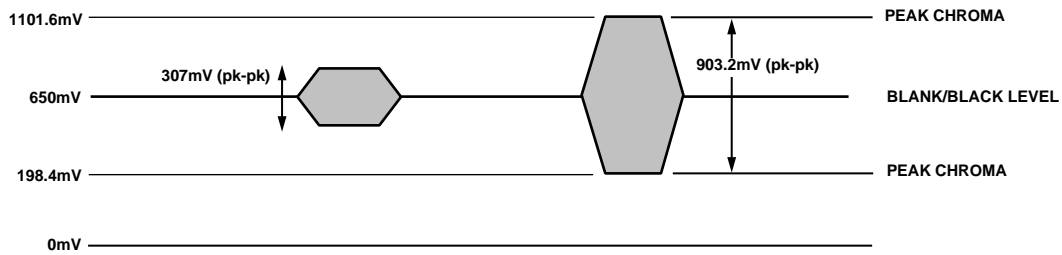

Figure 51. NTSC Chroma Video Levels

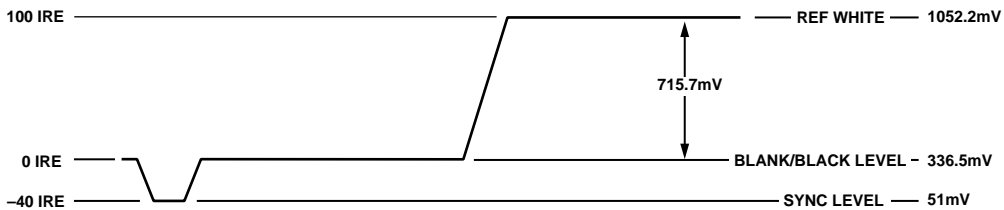

Figure 52. NTSC RGB Video Levels

PAL WAVEFORMS

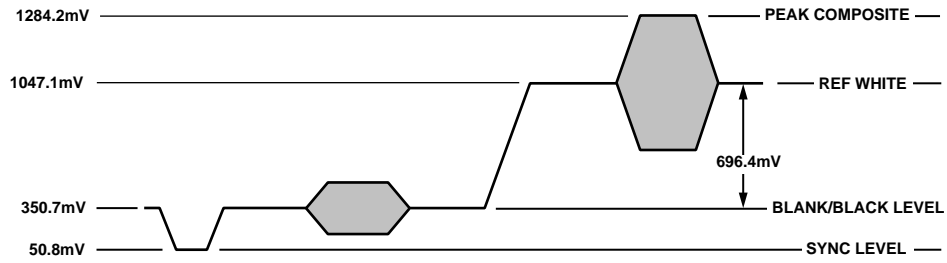

Figure 53. PAL Composite Video Levels

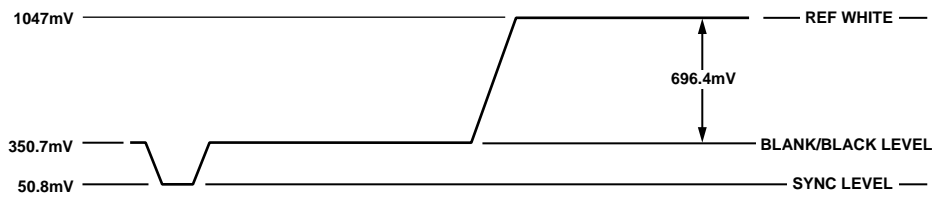

Figure 54. PAL Luma Video Levels

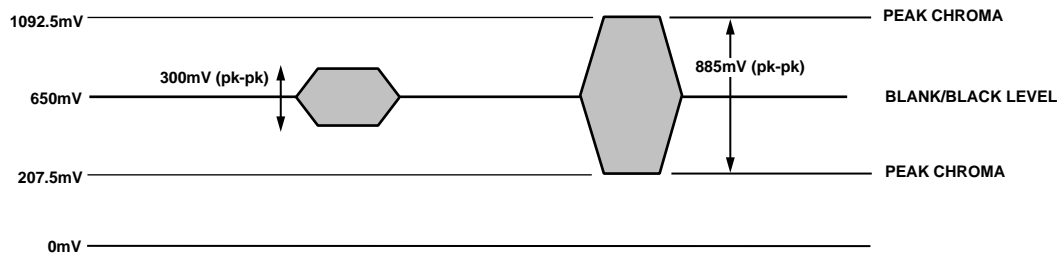

Figure 55. PAL Chroma Video Levels

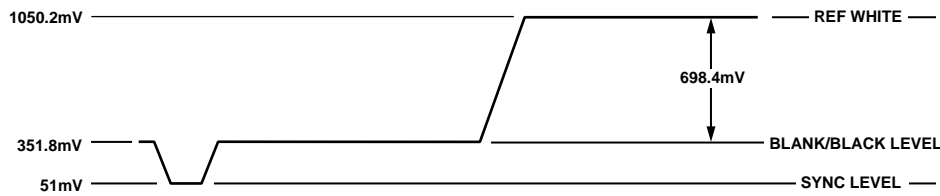

Figure 56. PAL RGB Video Levels

UV WAVEFORMS

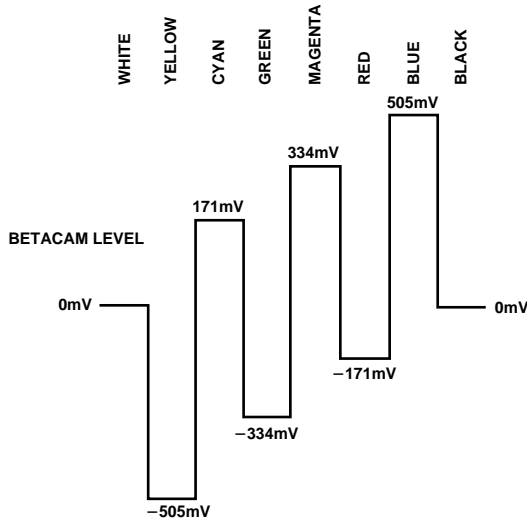

Figure 57. NTSC 100% Color Bars No Pedestal U Levels

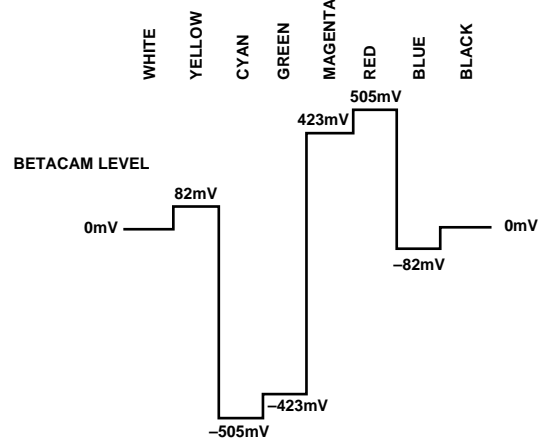

Figure 60. NTSC 100% Color Bars No Pedestal V Levels

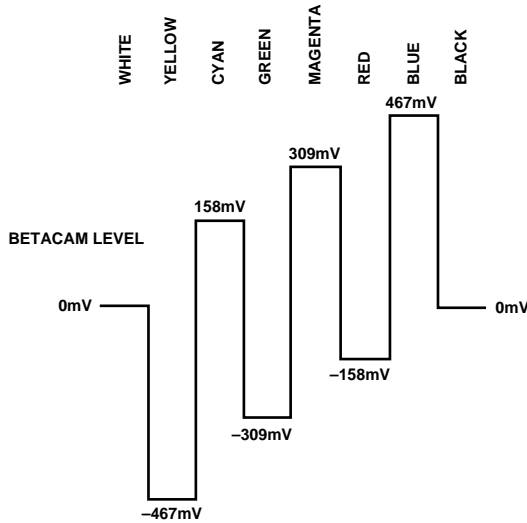

Figure 58. NTSC 100% Color Bars with Pedestal U Levels

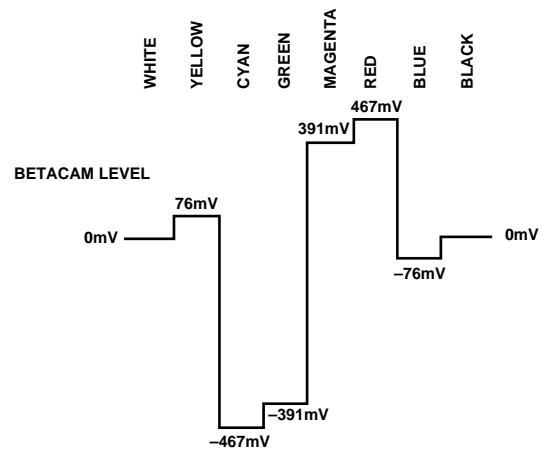

Figure 61. NTSC 100% Color Bars with Pedestal V Levels

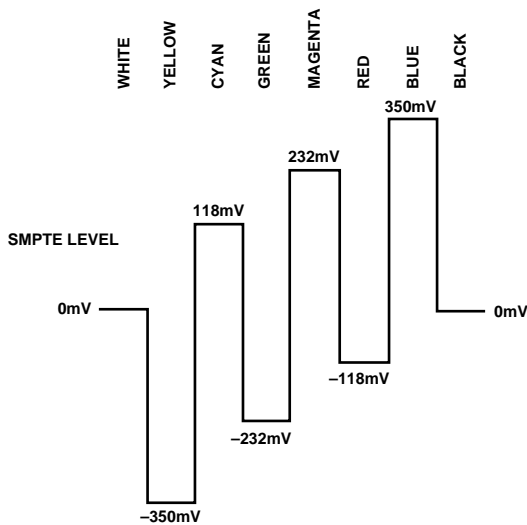

Figure 59. PAL 100% Color Bars U Levels

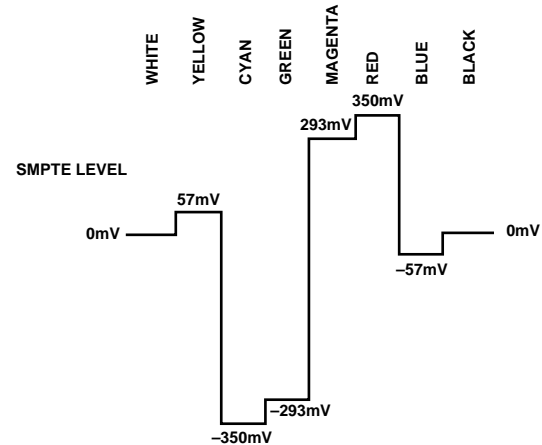

Figure 62. PAL 100% Color Bars V Levels

APPENDIX 4

REGISTER VALUES

The ADV7177/ADV7178 registers can be set depending on the user standard required.

The following examples give the various register formats for several video standards.

In each case the output is set to composite o/p with all DACs powered up and with the $\overline{\text{BLANK}}$ input control disabled. Additionally, the burst and color information are enabled on the output and the internal color bar generator is switched off. In the examples shown, the timing mode is set to Mode 0 in slave format. TR02–TR00 of the Timing Register 0 control the timing modes. For a detailed explanation of each bit in the command registers, please turn to the Register Programming section of the data sheet. TR07 should be toggled after setting up a new timing mode. Timing Register 1 provides additional control over the position and duration of the timing signals. In the examples, this register is programmed in default mode.

NTSC ($F_{SC} = 3.5795454 \text{ MHz}$)

| Address | Data |
|---------|----------------------------------|
| 00Hex | Mode Register 0 |
| 01Hex | Mode Register 1 |
| 02Hex | Subcarrier Frequency Register 0 |
| 03Hex | Subcarrier Frequency Register 1 |
| 04Hex | Subcarrier Frequency Register 2 |
| 05Hex | Subcarrier Frequency Register 3 |
| 06Hex | Subcarrier Phase Register |
| 07Hex | Timing Register 0 |
| 08Hex | Closed Captioning Ext Register 0 |
| 09Hex | Closed Captioning Ext Register 1 |
| 0AHex | Closed Captioning Register 0 |
| 0BHex | Closed Captioning Register 1 |
| 0CHex | Timing Register 1 |
| 0DHex | Mode Register 2 |
| 0EHex | Pedestal Control Register 0 |
| 0FHex | Pedestal Control Register 1 |
| 10Hex | Pedestal Control Register 2 |
| 11Hex | Pedestal Control Register 3 |
| 12Hex | Mode Register 3 |

PAL B, D, G, H, I ($F_{SC} = 4.43361875 \text{ MHz}$)

| Address | Data |
|---------|----------------------------------|
| 00Hex | Mode Register 0 |
| 01Hex | Mode Register 1 |
| 02Hex | Subcarrier Frequency Register 0 |
| 03Hex | Subcarrier Frequency Register 1 |
| 04Hex | Subcarrier Frequency Register 2 |
| 05Hex | Subcarrier Frequency Register 3 |
| 06Hex | Subcarrier Phase Register |
| 07Hex | Timing Register 0 |
| 08Hex | Closed Captioning Ext Register 0 |
| 09Hex | Closed Captioning Ext Register 1 |
| 0AHex | Closed Captioning Register 0 |
| 0BHex | Closed Captioning Register 1 |
| 0CHex | Timing Register 1 |
| 0DHex | Mode Register 2 |

| Address | Data |
|---------|-----------------------------|
| 0EHex | Pedestal Control Register 0 |
| 0FHex | Pedestal Control Register 1 |
| 10Hex | Pedestal Control Register 2 |
| 11Hex | Pedestal Control Register 3 |
| 12Hex | Mode Register 3 |

PAL M ($F_{SC} = 3.57561149 \text{ MHz}$)

| Address | Data |
|---------|----------------------------------|
| 00Hex | Mode Register 0 |
| 01Hex | Mode Register 1 |
| 02Hex | Subcarrier Frequency Register 0 |
| 03Hex | Subcarrier Frequency Register 1 |
| 04Hex | Subcarrier Frequency Register 2 |
| 05Hex | Subcarrier Frequency Register 3 |
| 06Hex | Subcarrier Phase Register |
| 07Hex | Timing Register 0 |
| 08Hex | Closed Captioning Ext Register 0 |
| 09Hex | Closed Captioning Ext Register 1 |
| 0AHex | Closed Captioning Register 0 |
| 0BHex | Closed Captioning Register 1 |
| 0CHex | Timing Register 1 |
| 0DHex | Mode Register 2 |
| 0EHex | Pedestal Control Register 0 |
| 0FHex | Pedestal Control Register 1 |
| 10Hex | Pedestal Control Register 2 |
| 11Hex | Pedestal Control Register 3 |
| 12Hex | Mode Register 3 |

APPENDIX 5

OPTIONAL OUTPUT FILTER

If an output filter is required for the CVBS, Y, UV, Chroma and RGB outputs of the ADV7177/ADV7178, the following filter in Figure 63 can be used. Plots of the filter characteristics are shown in Figures 64, 65 and 66. An output filter is not required if the outputs of the ADV7177/ADV7178 are connected to an analog monitor or an analog TV; however, if the output signals are applied to a system where sampling is used (e.g., digital TV), a filter is required to prevent aliasing.

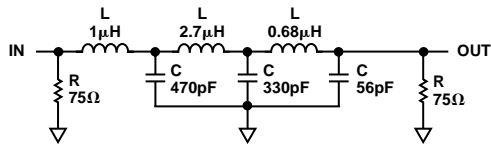

Figure 63. Output Filter

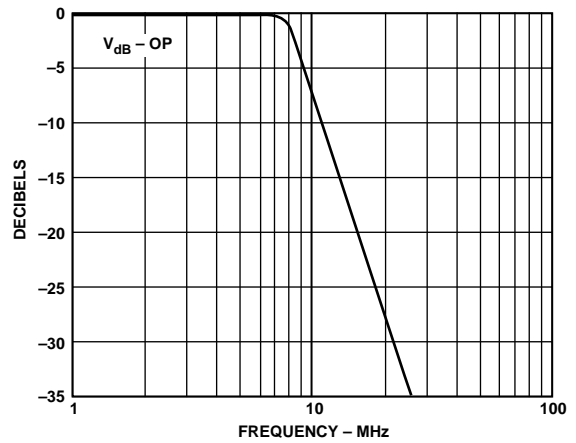

Figure 65. Output Filter Close Up

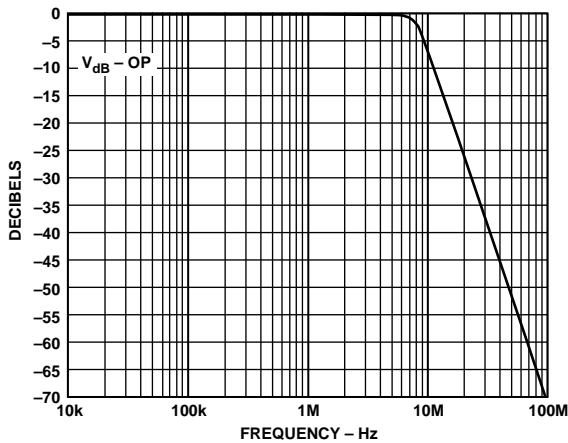

Figure 64. Output Filter Plot

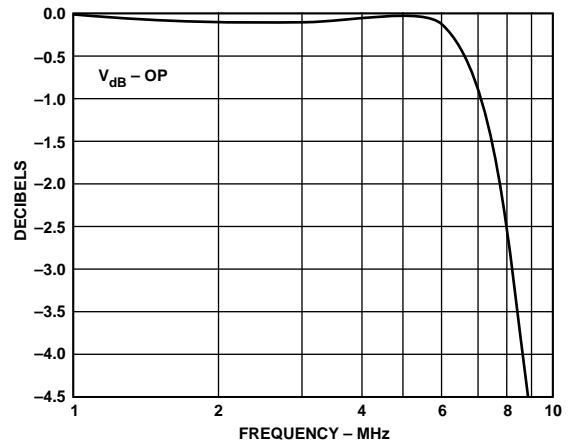

Figure 66. Output Filter Plot Close Up

APPENDIX 6

OPTIONAL DAC BUFFERING

For external buffering of the ADV7177/ADV7178 DAC outputs, the configuration in Figure 67 is recommended. This configuration shows the DAC outputs running at half (18 mA) their full current (34.7 mA) capability. This will allow the ADV7177/ADV7178 to dissipate less power, the analog current is reduced by 50% with a R_{SET} of 300 Ω and a R_{LOAD} of 75 Ω . This mode is recommended for 3.3 volt operation as optimum performance is obtained from the DAC outputs at 18 mA with a V_{AA} of 3.3 volts. This buffer also adds extra isolation on the video out-

puts, see buffer circuit in Figure 68. When calculating absolute output full current and voltage, use the following equation:

$$V_{OUT} = I_{OUT} \times R_{LOAD}$$

$$I_{OUT} = \frac{(V_{REF} \times K)}{R_{SET}}$$

$$K = 4.2146 \text{ constant, } V_{REF} = 1.235 \text{ V}$$

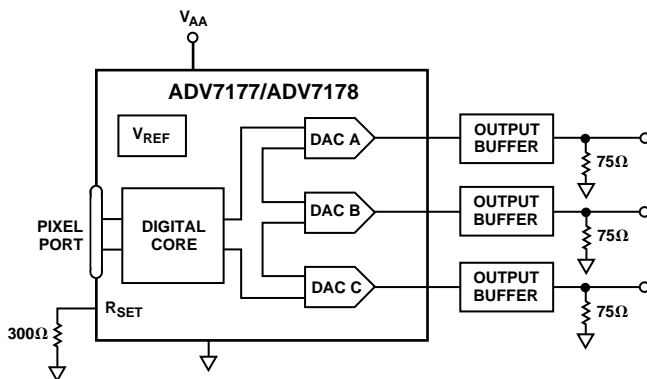

Figure 67. Output DAC Buffering Configuration

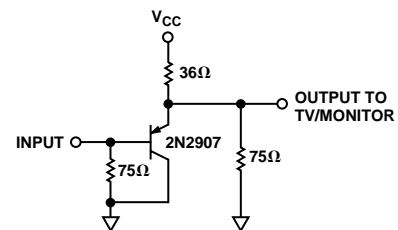
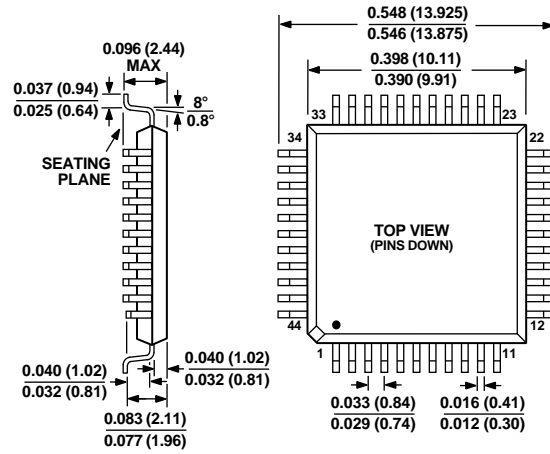

Figure 68. Recommended Output DAC Buffer

OUTLINE DIMENSIONS

Dimensions shown in inches and (mm).

Plastic Quad Flatpack (S-44)



C3314-2.5-8/98

PRINTED IN U.S.A.