



CY7C185

8K x 8 Static RAM

Features

- High speed
 - 15 ns
- Fast t_{DOE}
- Low active power
 - 715 mW
- Low standby power
 - 220 mW
- CMOS for optimum speed/power
- Easy memory expansion with \overline{CE}_1 , CE_2 and \overline{OE} features
- TTL-compatible inputs and outputs
- Automatic power-down when deselected

Functional Description

The CY7C185 is a high-performance CMOS static RAM organized as 8192 words by 8 bits. Easy memory expansion is

provided by an active LOW chip enable (\overline{CE}_1), an active HIGH chip enable (CE_2), and active LOW output enable (\overline{OE}) and three-state drivers. This device has an automatic power-down feature (\overline{CE}_1 or CE_2), reducing the power consumption by 70% when deselected. The CY7C185 is in a standard 300-mil-wide DIP and SOJ package.

An active LOW write enable signal (\overline{WE}) controls the writing/reading operation of the memory. When \overline{CE}_1 and \overline{WE} inputs are both LOW and CE_2 is HIGH, data on the eight data input/output pins (I/O_0 through I/O_7) is written into the memory location addressed by the address present on the address pins (A_0 through A_{12}). Reading the device is accomplished by selecting the device and enabling the outputs, \overline{CE}_1 and \overline{OE} active LOW, CE_2 active HIGH, while \overline{WE} remains inactive or HIGH. Under these conditions, the contents of the location addressed by the information on address pins are present on the eight data input/output pins.

The input/output pins remain in a high-impedance state unless the chip is selected, outputs are enabled, and write enable (\overline{WE}) is HIGH. A die coat is used to insure alpha immunity.

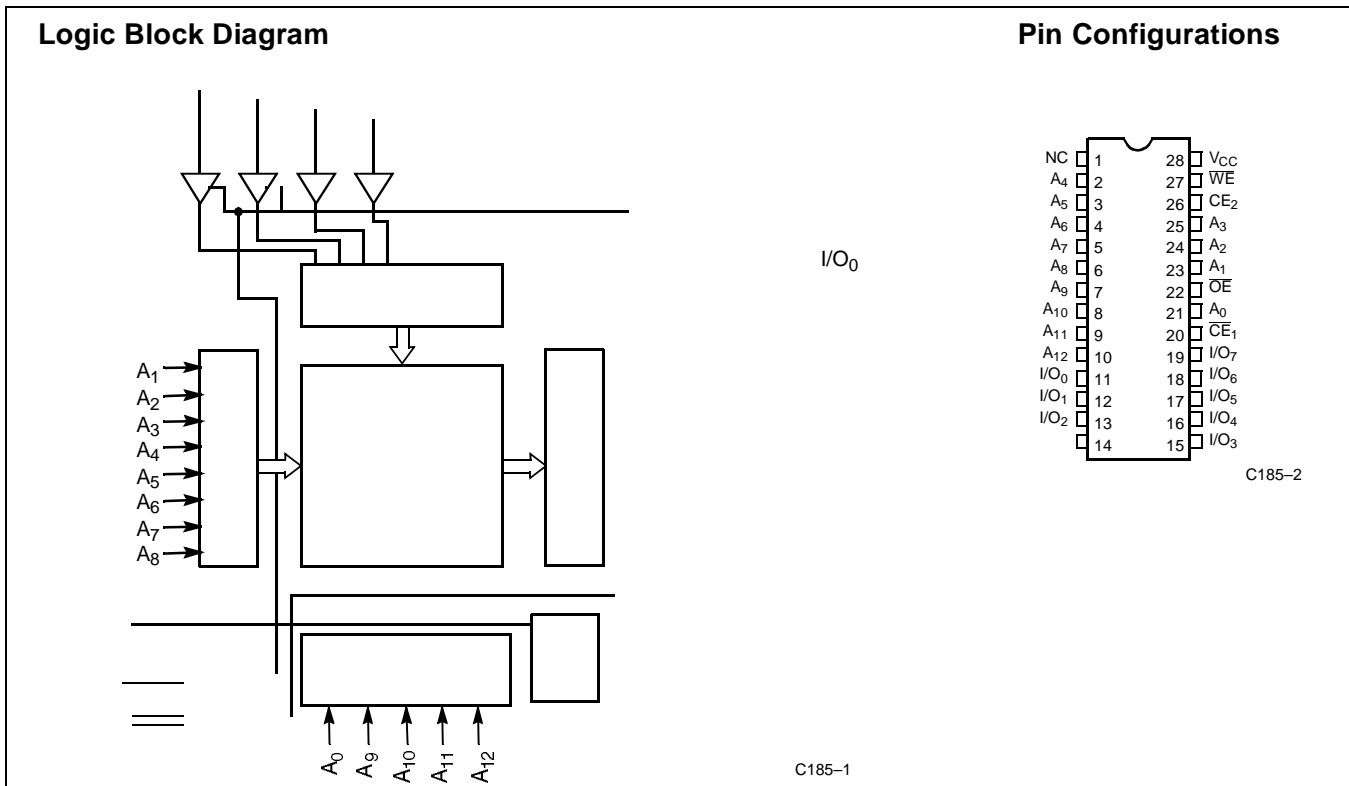



Pin Configurations (continued)

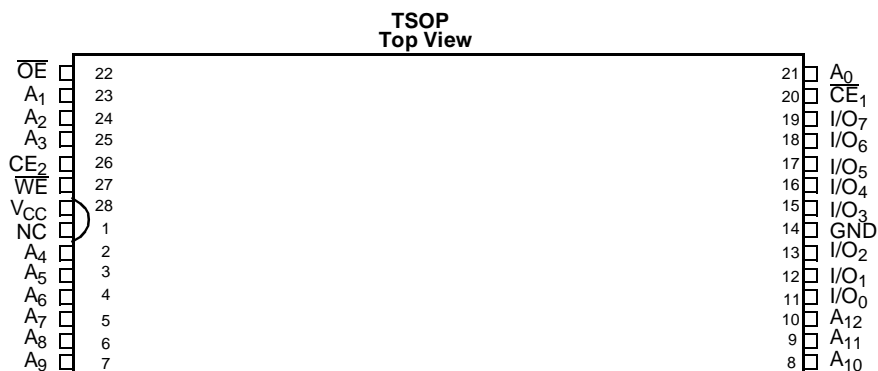

C185-3

Maximum Ratings

(Above which the useful life may be impaired. For user guidelines, not tested.)

Storage Temperature -65°C to +150°C

Ambient Temperature with Power Applied..... -55°C to +125°C

Supply Voltage to Ground Potential -0.5V to +7.0V

DC Voltage Applied to Outputs in High Z State^[2] -0.5V to +7.0V

DC Input Voltage^[2] -0.5V to +7.0V

Output Current into Outputs (LOW)..... 20 mA

Static Discharge Voltage >2001V (per MIL-STD-883, Method 3015)

Latch-Up Current..... >200 mA

Operating Range

Range	Ambient Temperature	V _{CC}
Commercial	0°C to +70°C	5V ± 10%

Electrical Characteristics Over the Operating Range

Parameter	Description	Test Conditions	7C185-12		7C185-15		Unit
			Min.	Max.	Min.	Max.	
V _{OH}	Output HIGH Voltage	V _{CC} = Min., I _{OH} = -4.0 mA	2.4		2.4		V
V _{OL}	Output LOW Voltage	V _{CC} = Min., I _{OL} = 8.0 mA		0.4		0.4	V
V _{IH}	Input HIGH Voltage		2.2	V _{CC}	2.2	V _{CC}	V
V _{IL}	Input LOW Voltage ^[2]		-0.5	0.8	-0.5	0.8	V
I _{IX}	Input Load Current	GND ≤ V _I ≤ V _{CC}	-5	+5	-5	+5	μA
I _{OZ}	Output Leakage Current	GND ≤ V _I ≤ V _{CC} , Output Disabled	-5	+5	-5	+5	μA
I _{OS}	Output Short Circuit Current ^[3]	V _{CC} = Max., V _{OUT} = GND		-300		-300	mA
I _{CC}	V _{CC} Operating Supply Current	V _{CC} = Max., I _{OUT} = 0 mA		140		130	mA
I _{SB1}	Automatic Power-Down Current	Max. V _{CC} , $\overline{CE}_1 \geq V_{IH}$ or CE ₂ ≤ V _{IL} Min. Duty Cycle=100%	40		40		mA
I _{SB2}	Automatic Power-Down Current	Max. V _{CC} , $\overline{CE}_1 \geq V_{CC} - 0.3V$, or CE ₂ ≤ 0.3V V _{IN} ≥ V _{CC} - 0.3V or V _{IN} ≤ 0.3V	15		15		mA

Shaded areas contain preliminary information.

Notes:

2. Minimum voltage is equal to -3.0V for pulse durations less than 30 ns.
3. -Not more than 1 output should be shorted at one time. Duration of the short circuit should not exceed 30 seconds.



Electrical Characteristics Over the Operating Range (continued)

Parameter	Description	Test Conditions	7C185-20		7C185-25, 35		Unit
			Min.	Max.	Min.	Max.	
V _{OH}	Output HIGH Voltage	V _{CC} = Min., I _{OH} = -4.0 mA	2.4		2.4		V
V _{OL}	Output LOW Voltage	V _{CC} = Min., I _{OL} = 8.0 mA		0.4		0.4	V
V _{IH}	Input HIGH Voltage		2.2	V _{CC}	2.2	V _{CC}	V
V _{IL}	Input LOW Voltage ^[2]		-0.5	0.8	-0.5	0.8	V
I _{IX}	Input Load Current	GND ≤ V _I ≤ V _{CC}	-5	+5	-5	+5	μA
I _{OZ}	Output Leakage Current	GND ≤ V _I ≤ V _{CC} , Output Disabled	-5	+5	-5	+5	μA
I _{OS}	Output Short Circuit Current ^[3]	V _{CC} = Max., V _{OUT} = GND		-300		-300	mA
I _{CC}	V _{CC} Operating Supply Current	V _{CC} = Max., I _{OUT} = 0 mA		110		100	mA
I _{SB1}	Automatic Power-Down Current	Max. V _{CC} , $\overline{CE}_1 \geq V_{IH}$ or $CE_2 \leq V_{IL}$ Min. Duty Cycle=100%		20		20	mA
I _{SB2}	Automatic Power-Down Current	Max. V _{CC} , $\overline{CE}_1 \geq V_{CC} - 0.3V$ or $CE_2 \leq 0.3V$ V _{IN} ≥ V _{CC} - 0.3V or V _{IN} ≤ 0.3V		15		15	mA

Capacitance^[4]

Parameter	Description	Test Conditions	Max.	Unit
C _{IN}	Input Capacitance	T _A = 25°C, f = 1 MHz, V _{CC} = 5.0V	7	pF
C _{OUT}	Output Capacitance		7	pF

Note:

4. Tested initially and after any design or process changes that may affect these parameters.

AC Test Loads and Waveforms

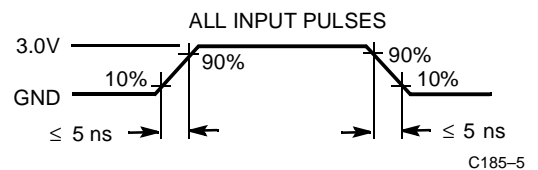
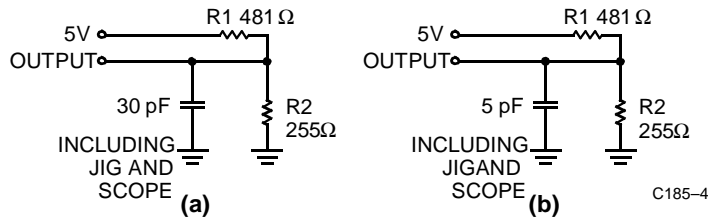

Equivalent to: THÉVENIN EQUIVALENT

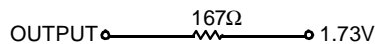

Switching Characteristics Over the Operating Range^[5]

Parameter	Description	7C185-12		7C185-15		7C185-20		7C185-25		7C185-35		Unit
		Min.	Max.	Min.	Max.	Min.	Max.	Min.	Max.	Min.	Max.	
READ CYCLE												
t _{RC}	Read Cycle Time	12		15		20		25		35		ns
t _{AA}	Address to Data Valid		12		15		20		25		35	ns
t _{OHA}	Data Hold from Address Change	3		3		5		5		5		ns
t _{ACE1}	\overline{CE}_1 LOW to Data Valid		12		15		20		25		35	ns
t _{ACE2}	CE ₂ HIGH to Data Valid		12		15		20		25		35	ns
t _{DOE}	\overline{OE} LOW to Data Valid		6		8		9		12		15	ns
t _{LZOE}	\overline{OE} LOW to Low Z	2		3		3		3		3		ns
t _{HZOE}	\overline{OE} HIGH to High Z ^[6]		6		7		8		10		10	ns
t _{LZCE1}	\overline{CE}_1 LOW to Low Z ^[7]	3		3		5		5		5		ns
t _{LZCE2}	CE ₂ HIGH to Low Z	3		3		3		3		3		ns
t _{HZCE}	\overline{CE}_1 HIGH to High Z ^[6, 7] CE ₂ LOW to High Z		6		7		8		10		10	ns
t _{PU}	\overline{CE}_1 LOW to Power-Up CE ₂ to HIGH to Power-Up	0		0		0		0		0		ns
t _{PD}	\overline{CE}_1 HIGH to Power-Down CE ₂ LOW to Power-Down		12		15		20		20		20	ns
WRITE CYCLE^[8]												
t _{WC}	Write Cycle Time	12		15		20		25		35		ns
t _{SCE1}	\overline{CE}_1 LOW to Write End	8		12		15		20		20		ns
t _{SCE2}	CE ₂ HIGH to Write End	8		12		15		20		20		ns
t _{AW}	Address Set-Up to Write End	9		12		15		20		25		ns
t _{HA}	Address Hold from Write End	0		0		0		0		0		ns
t _{SA}	Address Set-Up to Write Start	0		0		0		0		0		ns
t _{PWE}	\overline{WE} Pulse Width	8		12		15		15		20		ns
t _{SD}	Data Set-Up to Write End	6		8		10		10		12		ns
t _{HD}	Data Hold from Write End	0		0		0		0		0		ns
t _{HZWE}	\overline{WE} LOW to High Z ^[6]		6		7		7		7		8	ns
t _{LZWE}	\overline{WE} HIGH to Low Z	3		3		5		5		5		ns

Shaded areas contain preliminary information.

Notes:

- Test conditions assume signal transition time of 5 ns or less, timing reference levels of 1.5V, input pulse levels of 0 to 3.0V, and output loading of the specified I_{OL}/I_{OH} and 30-pF load capacitance.
- t_{HZOE}, t_{HZCE}, and t_{HZWE} are specified with C_L = 5 pF as in part (b) of AC Test Loads. Transition is measured ±500 mV from steady state voltage.
- At any given temperature and voltage condition, t_{HZCE} is less than t_{LZCE1} and t_{LZCE2} for any given device.
- The internal write time of the memory is defined by the overlap of \overline{CE}_1 LOW, CE₂ HIGH, and \overline{WE} LOW. All 3 signals must be active to initiate a write and either signal can terminate a write by going HIGH. The data input set-up and hold timing should be referenced to the rising edge of the signal that terminates the write.



Switching Waveforms

Read Cycle No.1^[9,10]

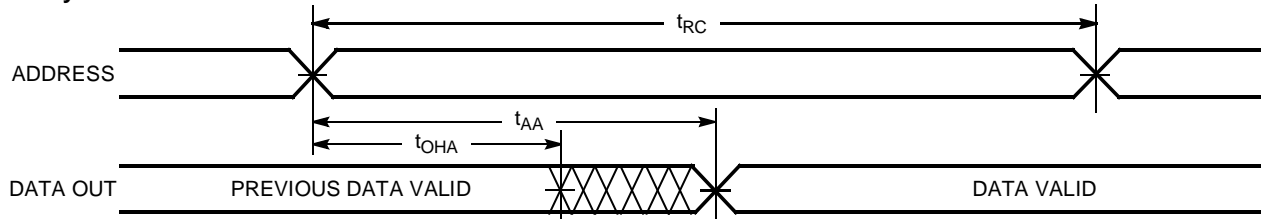

C185-6

Read Cycle No.2^[11,12]

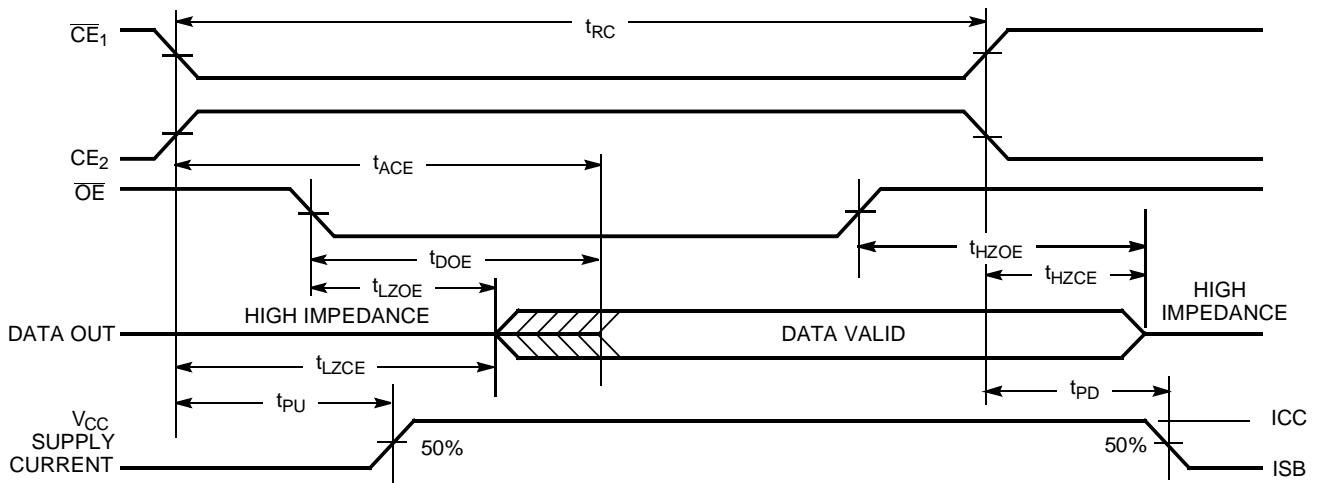

C185-7

Write Cycle No. 1 (\overline{WE} Controlled)^[10,12]

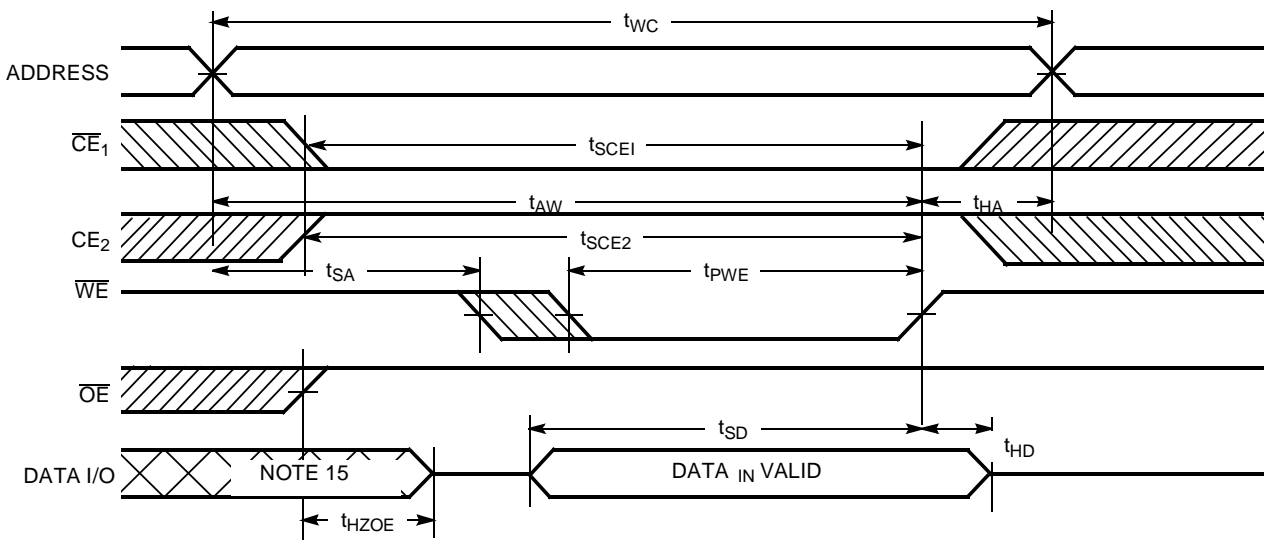

C185-8

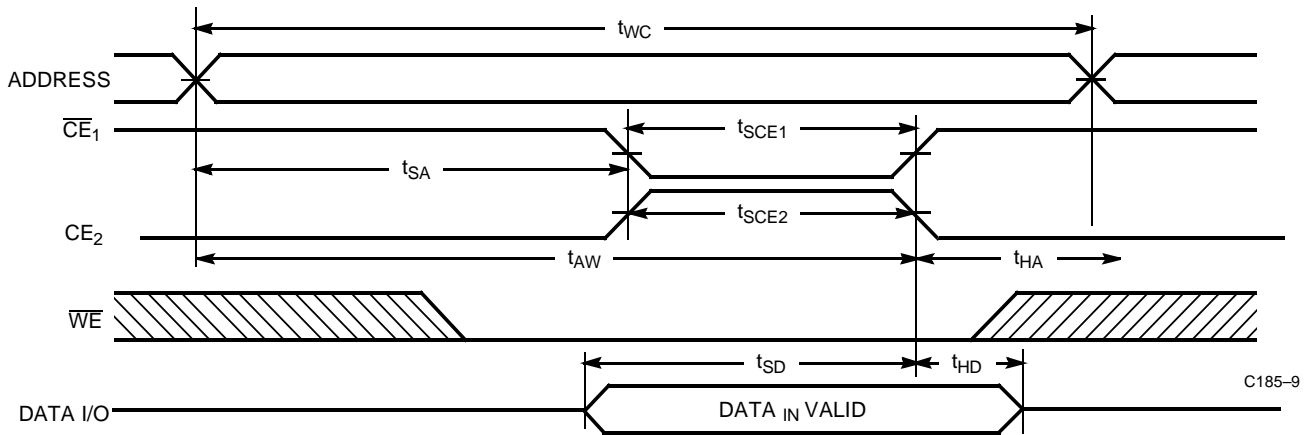
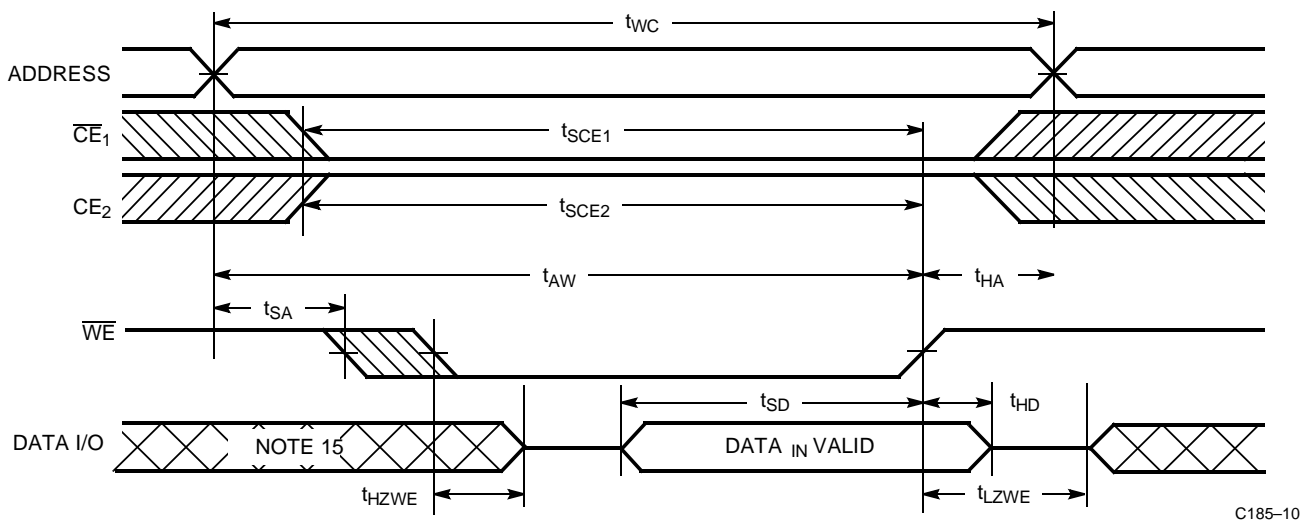
Switching Waveforms (continued)
Write Cycle no.2 (\overline{CE} Controlled)^[12,13,15]

Write Cycle No.3 (\overline{WE} Controlled, \overline{OE} LOW)^[12,13,14,15]

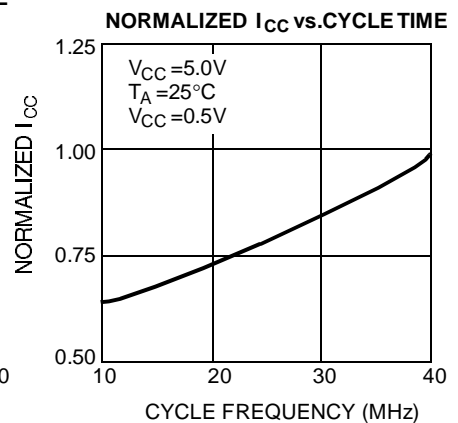
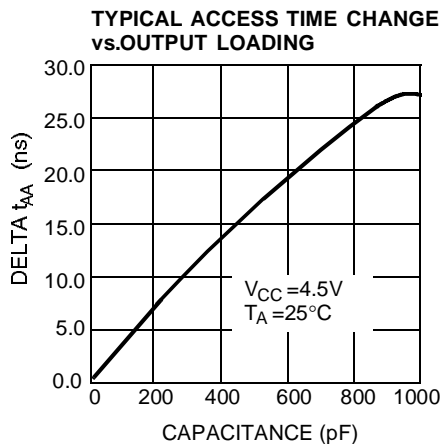
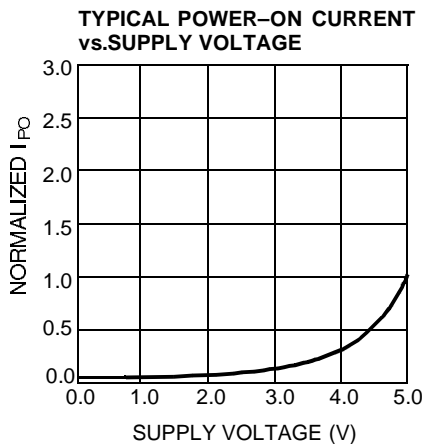
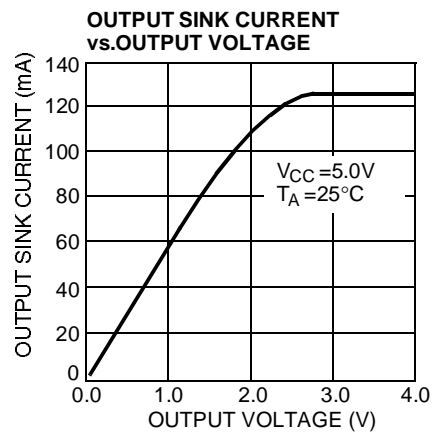
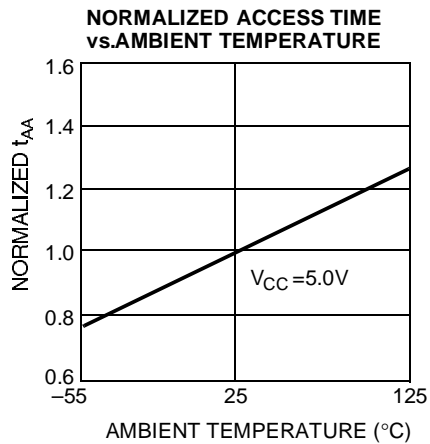
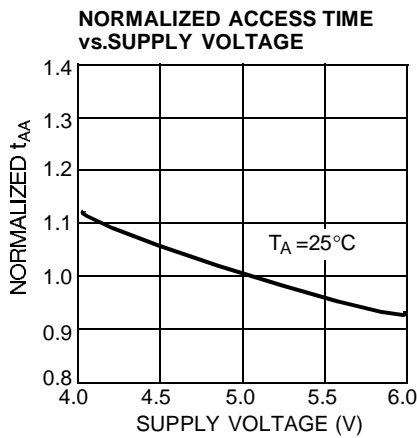
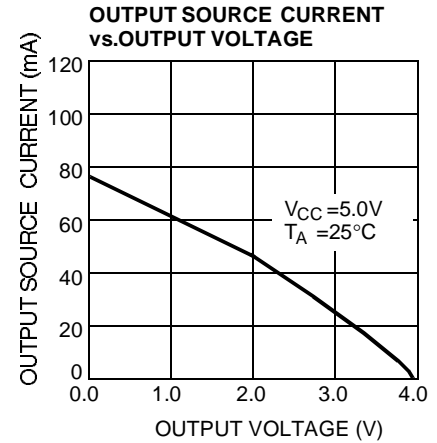
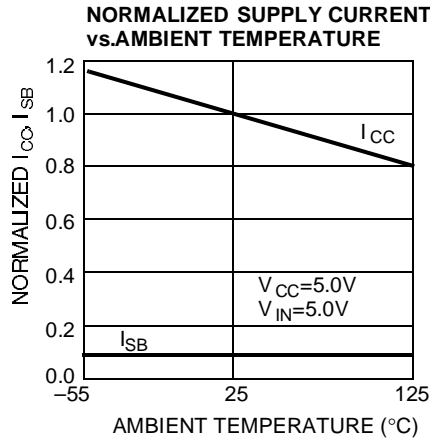
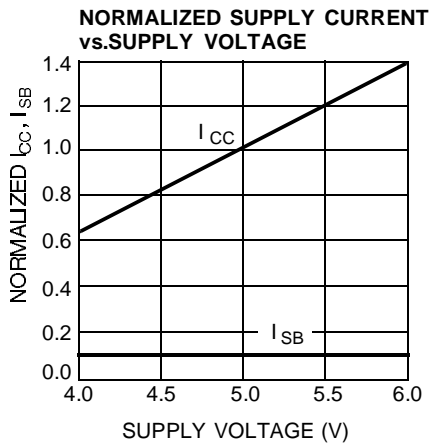
Notes:

9. Device is continuously selected. \overline{OE} , $\overline{CE}_1 = V_{IL}$. $CE_2 = V_{IH}$.
10. \overline{WE} is HIGH for read cycle.
11. Data I/O is High Z if $\overline{OE} = V_{IH}$, $\overline{CE}_1 = V_{IH}$, $\overline{WE} = V_{IL}$ or $CE_2 = V_{IL}$.
12. The internal write time of the memory is defined by the overlap of \overline{CE}_1 LOW, CE_2 HIGH and \overline{WE} LOW. \overline{CE}_1 and \overline{WE} must be LOW and CE_2 must be HIGH to initiate write. A write can be terminated by \overline{CE}_1 or \overline{WE} going HIGH or CE_2 going LOW. The data input set-up and hold timing should be referenced to the rising edge of the signal that terminates the write.
13. The minimum write cycle time for write cycle #3 (\overline{WE} controlled, \overline{OE} LOW) is the sum of t_{HZWE} and t_{SD} .
14. If \overline{CE}_1 goes HIGH or CE_2 goes LOW simultaneously with \overline{WE} HIGH, the output remains in a high-impedance state.
15. During this period, the I/Os are in the output state and input signals should not be applied.

Typical DC and AC Characteristics



Truth Table

CE ₁	CE ₂	WE	OE	Input/Output	Mode
H	X	X	X	High Z	Deselect/Power-Down
X	L	X	X	High Z	Deselect/Power-Down
L	H	H	L	Data Out	Read
L	H	L	X	Data In	Write
L	H	H	H	High Z	Deselect

Address Designators

Address Name	Address Function	Pin Number
A4	X3	2
A5	X4	3
A6	X5	4
A7	X6	5
A8	X7	6
A9	Y1	7
A10	Y4	8
A11	Y3	9
A12	Y0	10
A0	Y2	21
A1	X0	23
A2	X1	24
A3	X2	25

Ordering Information

Speed (ns)	Ordering Code	Package Name	Package Type	Operating Range
12	CY7C185-12PC	P21	28-Lead (300-Mil) Molded DIP	Commercial
	CY7C185-12VC	V21	28-Lead Molded SOJ	
15	CY7C185-15PC	P21	28-Lead (300-Mil) Molded DIP	Commercial
	CY7C185-15VC	V21	28-Lead Molded SOJ	
	CY7C185-15ZC	Z28	28-Lead Thin Small Outline Package	
20	CY7C185-20PC	P21	28-Lead (300-Mil) Molded DIP	Commercial
	CY7C185-20VC	V21	28-Lead Molded SOJ	
	CY7C185-20ZC	Z28	28-Lead Thin Small Outline Package	
25	CY7C185-25PC	P21	28-Lead (300-Mil) Molded DIP	Commercial
	CY7C185-25VC	V21	28-Lead Molded SOJ	
	CY7C185-25ZC	Z28	28-Lead Thin Small Outline Package	
35	CY7C185-35PC	P21	28-Lead (300-Mil) Molded DIP	Commercial
	CY7C185-35VC	V21	28-Lead Molded SOJ	
	CY7C185-35ZC	Z28	28-Lead Thin Small Outline Package	

Shaded areas contain preliminary information.

Package Diagrams

28-Lead (300-Mil) Molded DIP P21

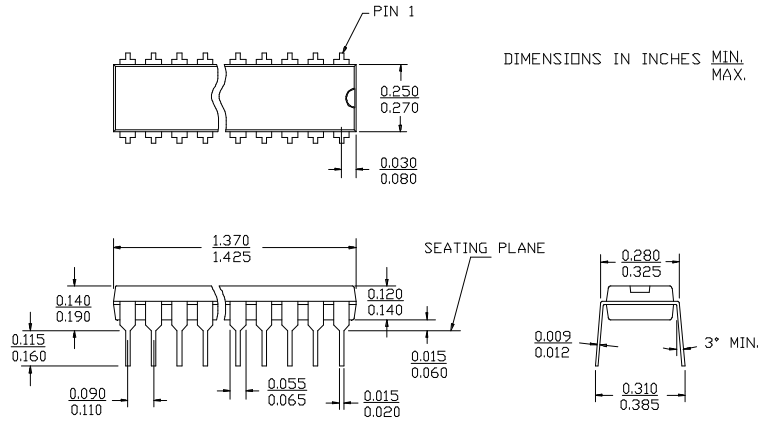

28-Lead Molded SOJ V21

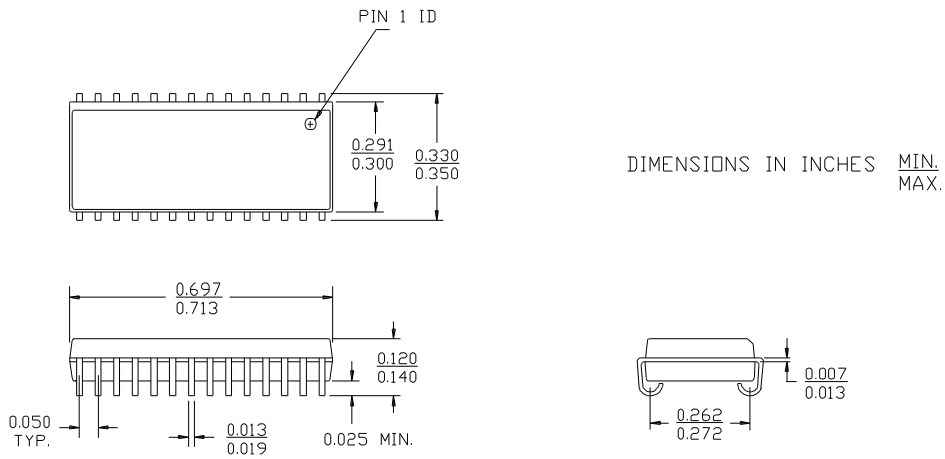

Package Diagrams (continued)

28-Lead Thin Small outline Package Z28

DIMENSION IN MM (INCH)
MAX.
MIN.

