

C-13/15-FXXM-PX-XXXX/XXX-XX

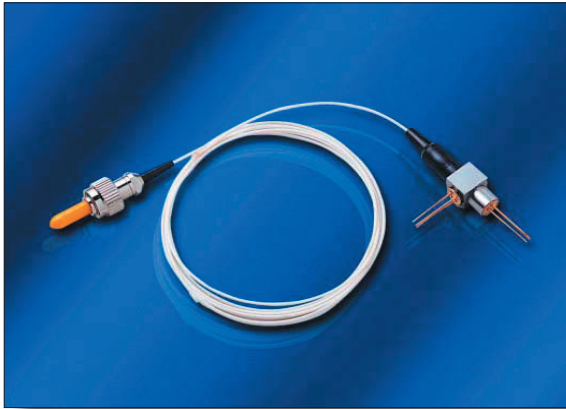

Features

- Single fiber bi-directional operation
- Laser diode with multi-quantum- well structure
- Low threshold current
- InGaAs/InP PIN Photodiode with trans-impedance amplifier
- High sensitivity with AGC*
- Differential ended output
- Single +3.3V Power Supply
- Integrated WDM coupler
- Un-cooled operation from -40°C to +85°C
- Hermetically sealed active component
- SM/MM fiber pigtailed packaging with optional FC/ST/SC/MU/LC- connector
- Design for fiber optic networks application
- RoHS Compliant available

Absolute Maximum Rating (Tc=25°C)

Parameter	Symbol	Value	Unit
Fiber Output Power L/M/H	P_f	1(L)/1.5(M)/2.5(H)	mW
LD Reverse Voltage	V_{RLD}	2	V
PIN-TIA Voltage	V_{CC}	4.5	V
Operating Temperature	T_{opr}	-40 to +85	°C
Storage Temperature	T_{stg}	-40 to +85	°C

(All optical data refer to a coupled 9/125µm SM fiber & 50/125µm MM fiber)

Optical and Electrical Characteristics (Tc=25°C)

Parameter	Symbol	Min	Typical	Max	Unit	Test Condition
Laser Diode						
Optical Output Power	L	0.2	0.35	0.5	mW	CW, $I_{th}+20mA$, kink free
	M	0.5	0.75	1		
	H	1	1.6	-		
Peak Wavelength	λ	1290	1310	1330	nm	CW, $P_f=P_f(\text{Min})$
Spectrum Width (RMS)	$\Delta\lambda$	-	-	5	nm	CW, $P_f=P_f(\text{Min})$
Threshold Current	I_{th}	-	10	15	mA	CW
Forward Voltage	V_f	-	1.2	1.5	V	CW, $P_f=P_f(\text{Min})$
Rise/Fall Time	t_r/t_f	-	-	0.5	ns	$I_{bias}=I_{th}$, 10% to 90%
Monitor Diode						
Monitor Current	I_m	100	-	-	µA	CW, $P_f=P_f(\text{Min})$, $V_{RPD}=2V$
Dark Current	I_{DARK}	-	-	0.1	µA	$V_{RPD}=5V$
Capacitance	C_t	-	6	15	pF	$V_{RPD}=5V$, $f=1MHz$
Module						
Tracking Error	$\Delta P_f/P_f$	-1.5	-	1.5	dB	APC, -40 to +85°C
Optical Crosstalk	CRT		< -40		dB	

Note:

- 1.Pin assignment can be customized.
- 2.Specifications subject to change without notice.

Detector $\lambda=1480-1600\text{nm}$

DC Electrical Characteristics (Tc=25°C)

Parameter	Symbol	Min	Typical	Max	Unit	Test Condition	
Power Supply	V _{cc}	3.0	3.3	3.6	V		
Differential Output Voltage	V _d	F02	-	-	1000	mV	
		F04	-	260	450		
		F06	185	250	415		
Supply Current (no load)	I _{cc}	F02	-	-	35	mA	
		F04	-	21	30		
		F06	-	26	50		

AC/Optical and Electrical Characteristics (Tc=25°C)

Parameter	Symbol	Min	Typical	Max	Unit	Test Condition	
Detection Range		1480	1550	1600	nm	-	
Gain @ 10 Mbps Differential	G	F02	52	-	70	V/mW	Measure differentially, AC coupled, R _L =50Ω
		F04	6	7	-		Measure differentially, AC coupled, R _L =50Ω
		F06	1.92	2.5	3.4		Measure differentially with 30uAp-p signal
Bandwidth	BW	F02	120	140	-	MHz	
		F04	404	470	-		
		F06	700	920	1100		
Saturation Power	P _{sat}	F02	-3	0	-	dBm	BER<10 ⁻¹⁰ @155Mbps PRBS 2 ²³ -1, Er=10dB
		F04	-7	-6	-		BER<10 ⁻¹⁰ @622Mbps PRBS 2 ²³ -1, Er=10dB
		F06	-3	-	-		BER<10 ⁻¹² @1.25Gbps PRBS 2 ⁷ -1, Er=10dB
Sensitivity	Sens.	F02	-	-38	-35	dBm	BER<10 ⁻¹⁰ @155Mbps PRBS 2 ²³ -1, Er=10dB
		F04	-	-33	-30		BER<10 ⁻¹⁰ @622Mbps PRBS 2 ²³ -1, Er=10dB
		F06	-	-26	-23		BER<10 ⁻¹² @1.25Gbps PRBS 2 ⁷ -1, Er=10dB
Output Resistance	R _{out}	F02	-	50	-	ohm	
		F04	48	50	52		
		F06	48	50	62		

Pin Assignment

LD Pin Assignment

A Type

- Pin 1 : Laser Cathode
- Pin 2 : Laser Anode and Case Gnd
- Pin 3 : Monitor Diode Anode
- Pin 4 : Monitor Diode Cathode

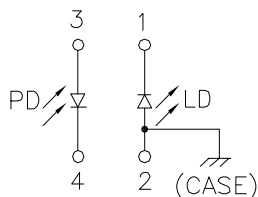

D Type

- Pin 1 : Laser Anode and Monitor Diode Cathode
- Pin 2 : Case Gnd
- Pin 3 : Laser Cathode
- Pin 4 : Monitor Diode Anode

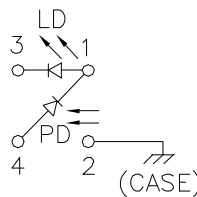

PIN-TIA Pin Assignment

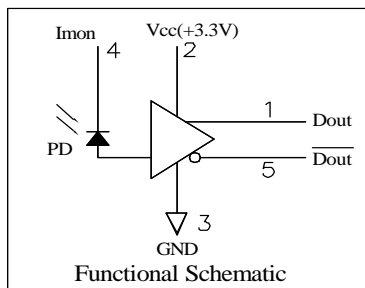

F02

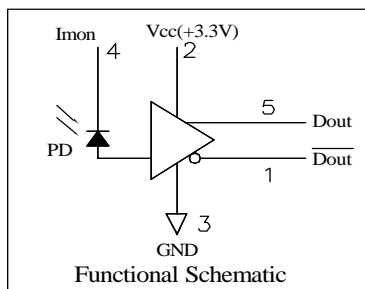
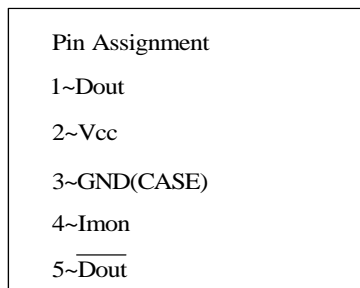

F04

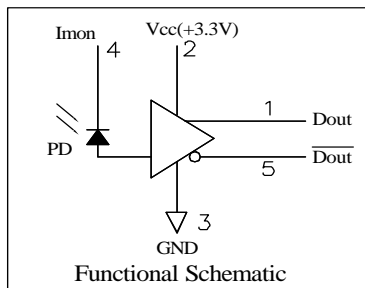
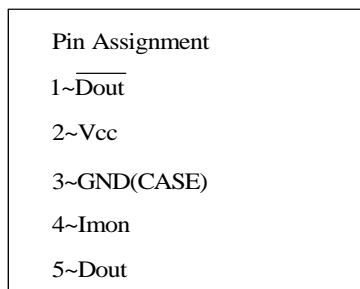

F06

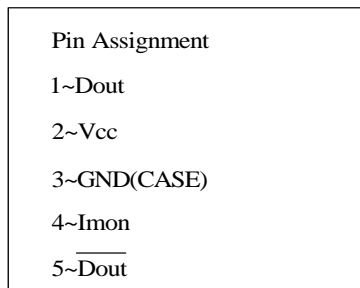

C-13/15-FXXM-PX-XXXX/XXX-XX

Outline Dimensions

Units in mm.

C-13/15-FXXM-PX-SXXX/XXX-XX

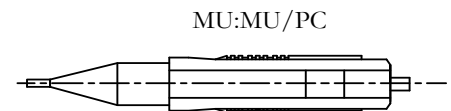
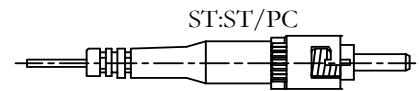
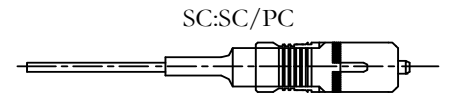
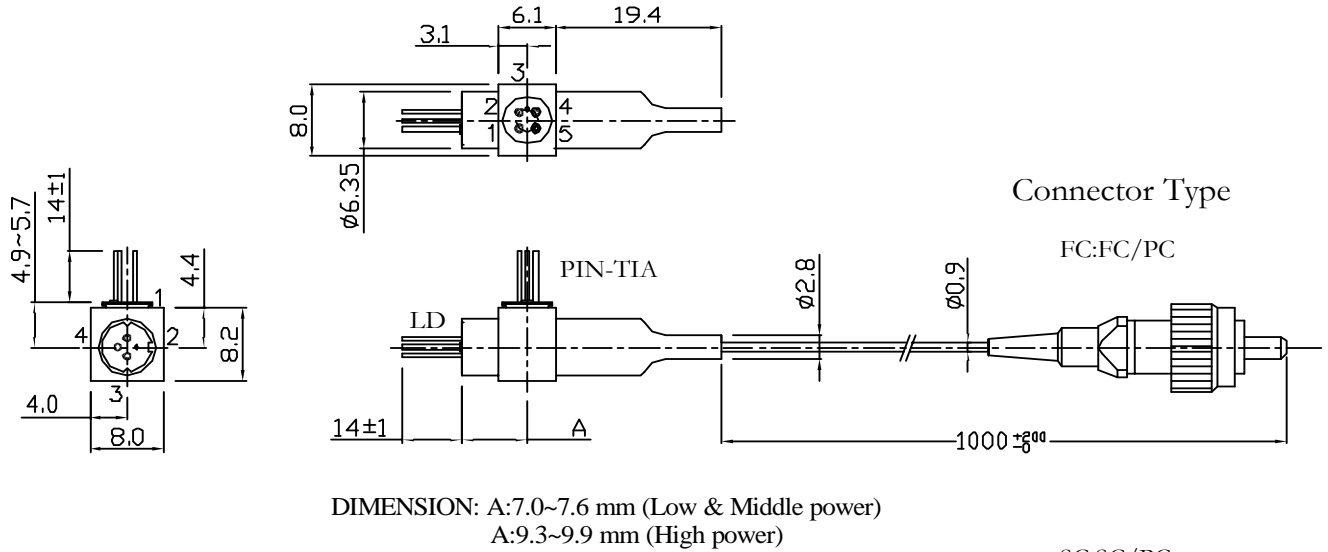

C-13/15-FXXM-PX-MXXX/XXX-XX

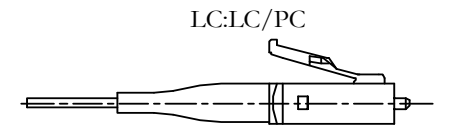
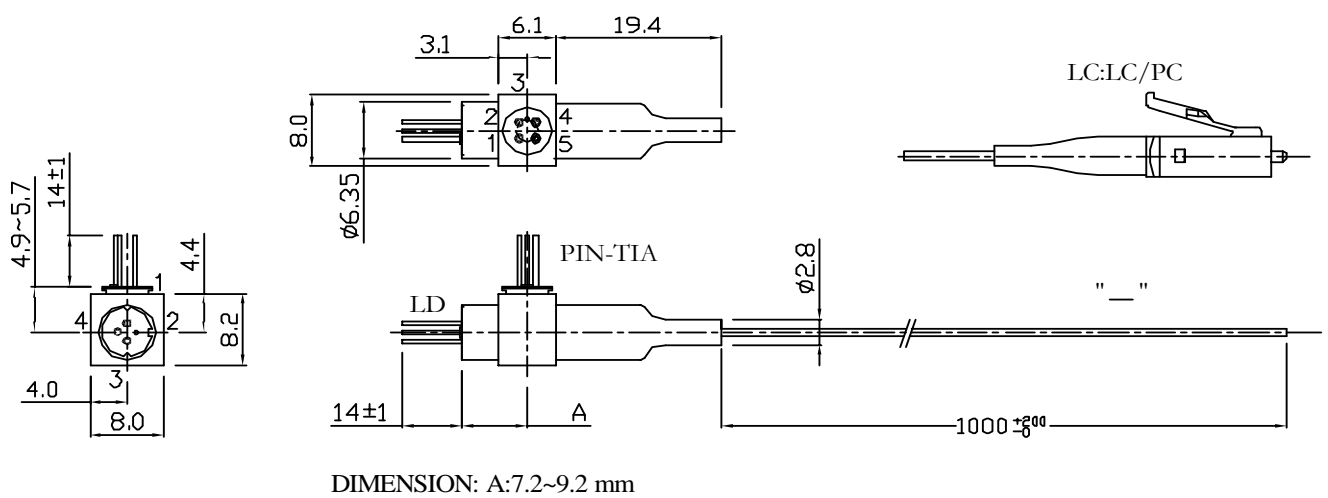

Ordering Information

C-13/15-FXXM-PX-XXXX/XXX-XX

1310nm Transmitter
1550nm Receiver

M = with 5 pinout

Pin Assignment
"." = A Type
D = D Type

Connector
FC/ST/SC/MU/LC/-

Fiber Output Power
L/M/H

" - " = PC Fiber
APC = APC Fiber
(for single mode)

02: 155 Mb/s PIN-TIA+3.3V
04: 622 Mb/s PIN-TIA+3.3V
06: 1250 Mb/s PIN-TIA+3.3V

Fiber Application
S=SM 9/125µm
M=MM 50/125µm

RoHS Compliant
-/G5/GR
Blank = RoHS non-compliant product
G5 = RoHS 5/6-compliant product (lead exemption)
GR = Full RoHS compliant product (no exemption)

Warnings

Handling Precautions: This device is susceptible to damage as a result of electrostatic discharge (ESD). A static free environment is highly recommended. Follow guidelines according to proper ESD procedures.
Laser Safety: Radiation emitted by laser devices can be dangerous to human eyes. Avoid eye exposure to direct or indirect radiation.

Legal Notice

IMPORTANT NOTICE!
All information contained in this document is subject to change without notice, at LuminentOIC's sole and absolute discretion. LuminentOIC warrants performance of its products to current specifications only in accordance with the company's standard one-year warranty; however, specifications designated as "preliminary" are given to describe components only, and LuminentOIC expressly disclaims any and all warranties for said products, including express, implied, and statutory warranties, warranties of merchantability, fitness for a particular purpose, and non-infringement of proprietary rights. Please refer to the company's Terms and Conditions of Sale for further warranty information.

LuminentOIC assumes no liability for applications assistance, customer product design, software performance, or infringement of patents, services, or intellectual property described herein. No license, either express or implied, is granted under any patent right, copyright, or intellectual property right, and LuminentOIC makes no representations or warranties that the product(s) described herein are free from patent, copyright, or intellectual property rights. Products described in this document are NOT intended for use in implantation or other life support applications where malfunction may result in injury or death to persons. LuminentOIC customers using or selling products for use in such applications do so at their own risk and agree to fully defend and indemnify LuminentOIC for any damages resulting from such use or sale.

THE INFORMATION CONTAINED IN THIS DOCUMENT IS PROVIDED ON AN "AS IS" BASIS. Customer agrees that LuminentOIC is not liable for any actual, consequential, exemplary, or other damages arising directly or indirectly from any use of the information contained in this document. Customer must contact LuminentOIC to obtain the latest version of this publication to verify, before placing any order, that the information contained herein is current.

© LuminentOIC, Inc. 2006
All rights reserved