

BIPOLAR ANALOG INTEGRATED CIRCUIT

μ PC1943,1944

ADJUSTABLE PRECISION SHUNT REGULATORS

DESCRIPTION

The μ PC1943,1944 are adjustable precision shunt regulators with guaranteed thermal stability. The output voltage can be set to any value between reference voltage (1.26 V) and 24 V by two external resistors.

These ICs can apply to error amplifier of switching regulators.

FEATURES

- Low voltage operation and High accuracy. $V_{REF} = 1.26 \text{ V} \pm 2.4 \%$
- Adjustable output voltage by two external resistors. $V_{REF} \leq V_{OUT} \leq 24 \text{ V}$
- Pin compatible to μ PC1093.

ORDERING INFORMATION

	Part Number	Package
★	μ PC1943T	Power mini mold (SOT-89)
★	μ PC1944T	Power mini mold (SOT-89)
	μ PC1944J	3-pin plastic SIP (TO-92)
	μ PC1944GR	8-pin plastic SOP (5.72 mm (225))

BLOCK DIAGRAM

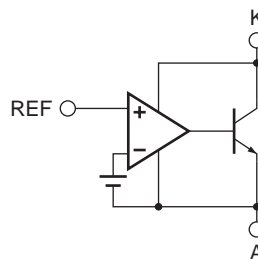

PIN CONFIGURATION (Marking Side)

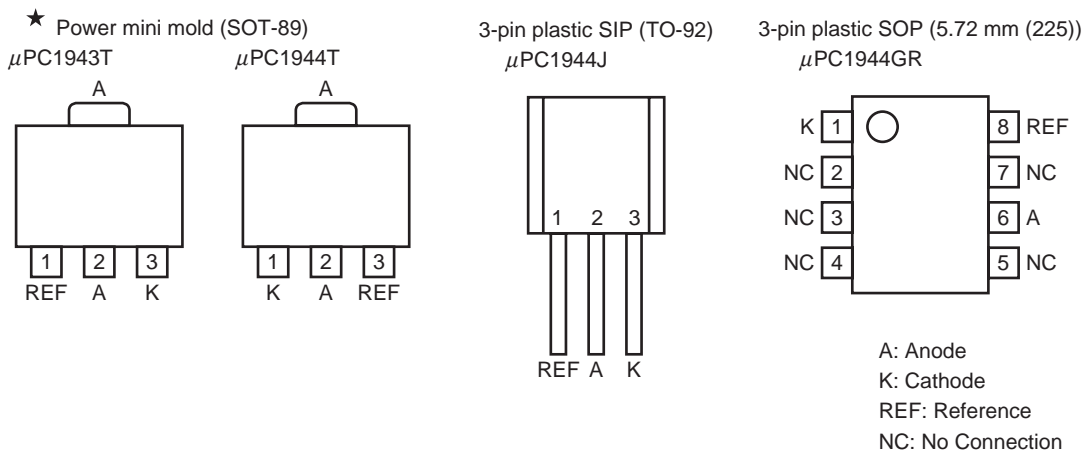

The information in this document is subject to change without notice. Before using this document, please confirm that this is the latest version.
Not all devices/types available in every country. Please check with local NEC representative for availability and additional information.

ABSOLUTE MAXIMUM RATINGS (T_A = +25 °C, unless otherwise specified.)

★
★
★

Parameter	Symbol	Ratings	Unit	
Cathode Voltage	V _{KA}	25	V	
Cathode Current	I _K	50	mA	
Cathode to Anode Reverse Current	- I _K	-30	mA	
Reference Voltage	V _{REF}	7	V	
Reference Input Current	I _{REF}	50	μA	
Reference to Anode Reverse Current	- I _{REF}	- 10	mA	
Total Power Dissipation	μ PC1943T	P _T	320 (1600 ^{Note})	mW
	μ PC1944T		320 (1600 ^{Note})	mW
	μ PC1944J		560	mW
	μ PC1944GR		385	mW
Operating Ambient Temperature	T _A	- 30 to + 85	°C	
Operating Junction Temperature	T _J	- 30 to + 125	°C	
Storage Temperature	T _{stg}	- 65 to + 125	°C	

Note with 16 cm² × 0.7 mm ceramic substrate.

Caution Product quality may suffer if the absolute maximum rating is exceeded even momentarily for any parameter. That is the absolute maximum ratings are rated values at which the product is on the verge of suffering physical damage, and therefore the product must be used under conditions that ensure that the absolute maximum ratings are not exceeded.

TYPICAL CONNECTION

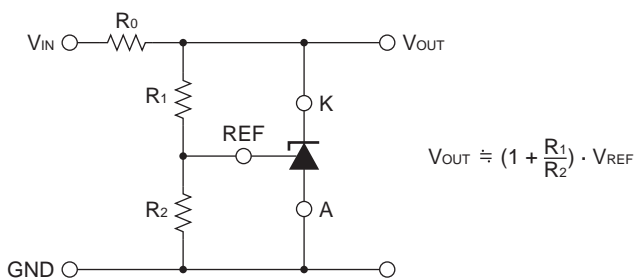

RECOMMENDED OPERATING CONDITIONS

★
★

Parameter		Symbol	MIN.	TYP.	MAX.	Unit
Cathode Voltage		V_{KA}	V_{REF}		24	V
Cathode Current		I_K	1	10	30	mA
Total Power Dissipation	μ PC1943T	P_T			45 (240 ^{Note})	mW
	μ PC1944T				45 (240 ^{Note})	mW
	μ PC1944J				83	mW
	μ PC1944GR				57	mW
Operating Ambient Temperature		T_A	-30		+85	°C
Operating Junction Temperature		T_J	-30		+100	°C

Note with 16 cm² × 0.7 mm ceramic substrate.

Caution The recommended operating range may be exceeded without causing any problems provided that the absolute maximum ratings are not exceeded. However, if the device is operated in a way that exceeds the recommended operating conditions, the margin between the actual conditions of use and the absolute maximum ratings is small, and therefore thorough evaluation is necessary. The recommended operating conditions do not imply that the device can be used with all values at their maximum values.

ELECTRICAL CHARACTERISTICS ($I_K = 10\text{ mA}$, $T_A = +25\text{ °C}$, unless otherwise specified.)

Parameter	Symbol	Conditions	MIN.	TYP.	MAX.	Unit
Reference Voltage	V_{REF}	$V_{KA} = V_{REF}$	1.23	1.26	1.29	V
Reference Voltage Deviation Over Temperature	ΔV_{REF}	$V_{KA} = V_{REF}$, $0\text{ °C} \leq T_A \leq 70\text{ °C}$		±5	±30	mV
Reference Voltage Deviation Over Cathode Voltage	$\Delta V_{REF}/\Delta V_{KA}$	$ V_{REF} \leq V_{KA} \leq 5V$			2.7	mV/V
		$5V \leq V_{KA} \leq 24V$			2.0	mV/V
Reference Input Current	I_{REF}	$V_{KA} = V_{REF}$, $R_1 = 10\text{ k}\Omega$, $R_2 = \infty$		2.0	4.0	μA
Reference Input Current Deviation Over Temperature	ΔI_{REF}	$V_{KA} = V_{REF}$, $0\text{ °C} \leq T_A \leq 70\text{ °C}$, $R_1 = 10\text{ k}\Omega$, $R_2 = \infty$		0.3	1.2	μA
Minimum Cathode Current	I_{Kmin}	$V_{KA} = V_{REF}$, $\Delta V_{REF} = 2\%$		0.16	1.0	mA
Off-state Cathode Current	I_{Koff}	$V_{KA} = 24\text{ V}$, $V_{REF} = 0\text{ V}$		0.01	1.0	μA
Dynamic Impedance	$ Z_{KA} $	$V_{KA} = V_{REF}$, $f \leq 1\text{ kHz}$, $1\text{ mA} \leq I_K \leq 30\text{ mA}$		0.12	0.5	Ω

TYPICAL CHARACTERISTIC ($T_A = +25^\circ\text{C}$, unless otherwise specified. Nominal)

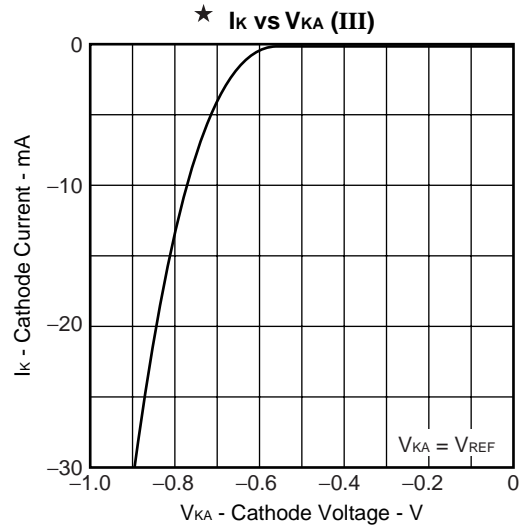
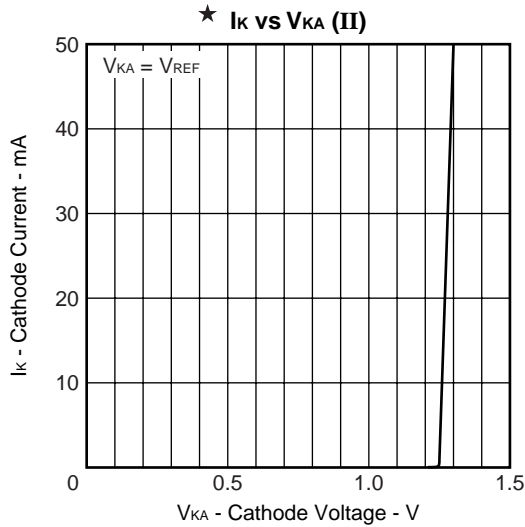
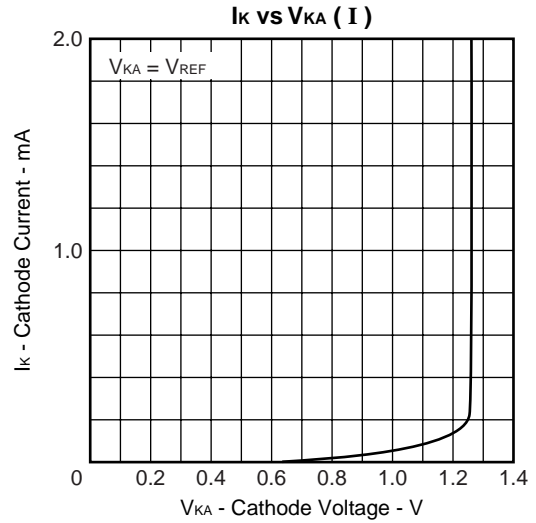
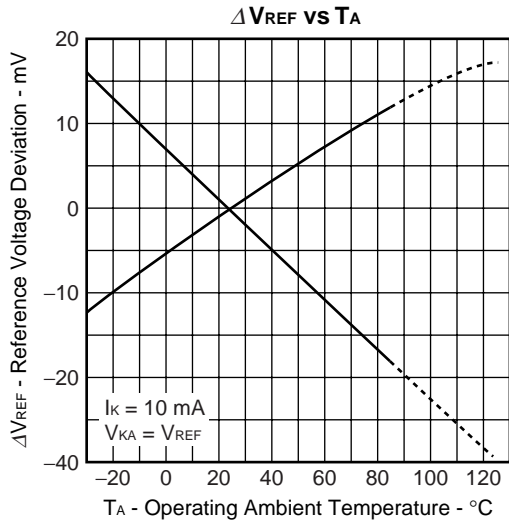
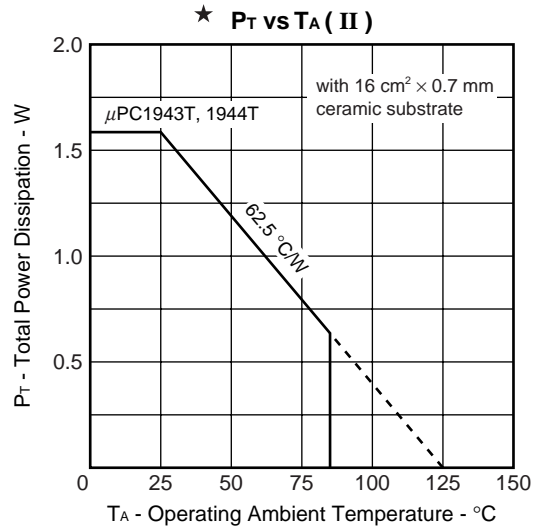
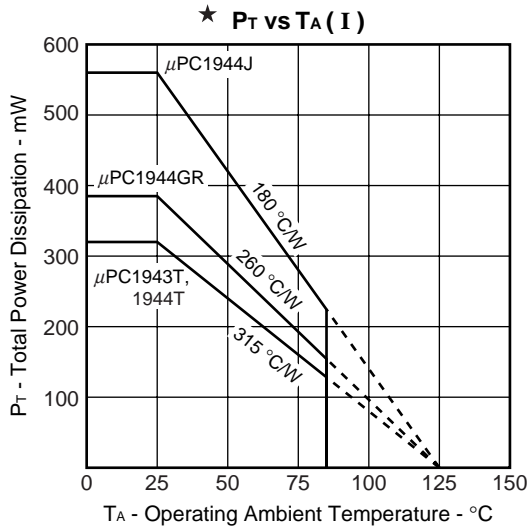

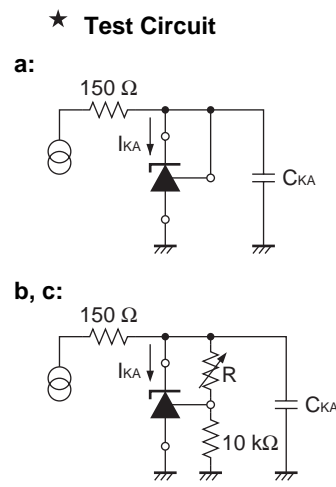
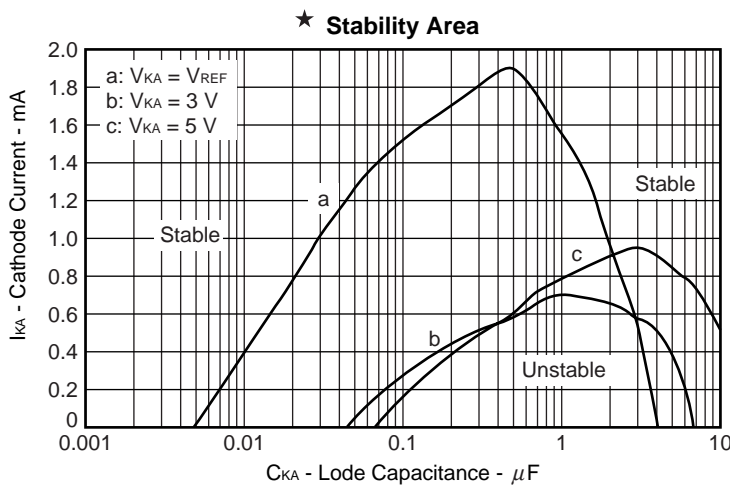
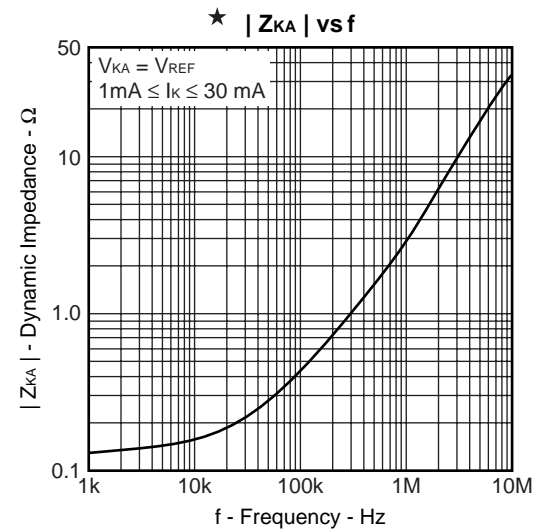
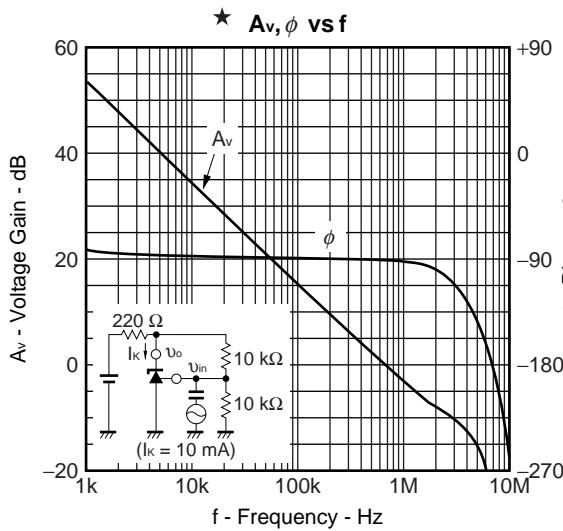
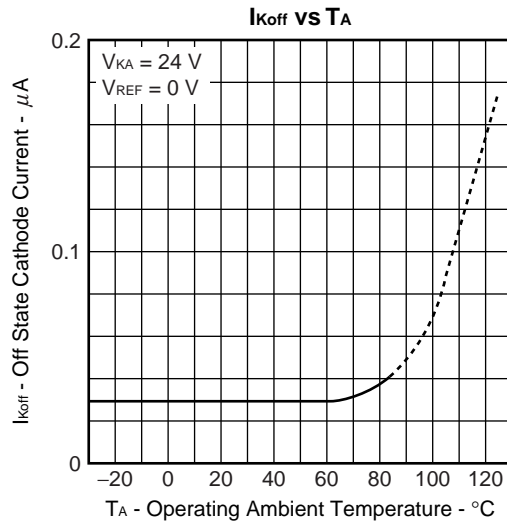
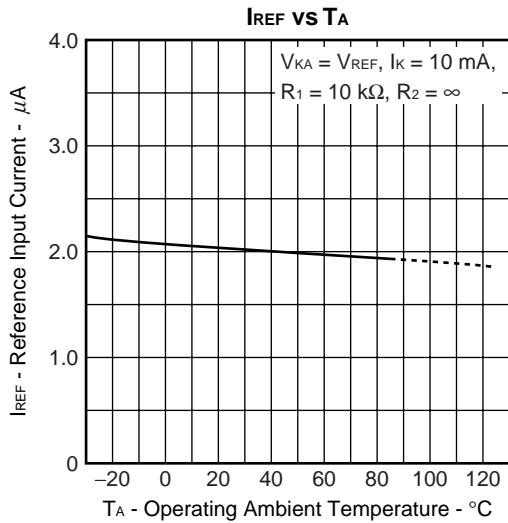

C_{KA}: Monolithic Ceramic Capacitor

★ **Caution of Stability Area**

If the Aluminum electrolytic capacitor is used, it should be kept $C_{KA} \geq 6.8 \mu F$. When using plural different types of capacitors, each capacitor is needed to be stable independently.

PACKAGE DRAWINGS

★ POWER MINI MOLD (SOT-89) (Unit: mm)

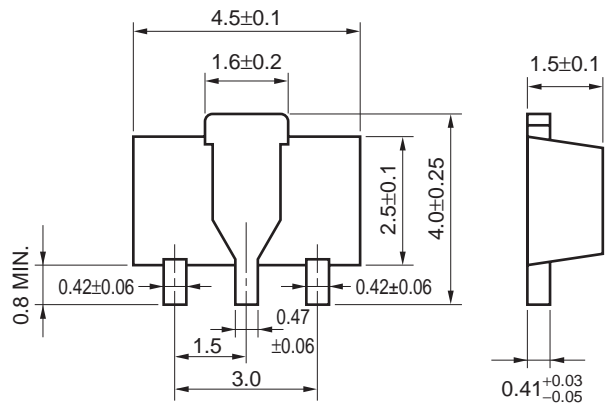

8-PIN PLASTIC SOP (5.72 mm (225))

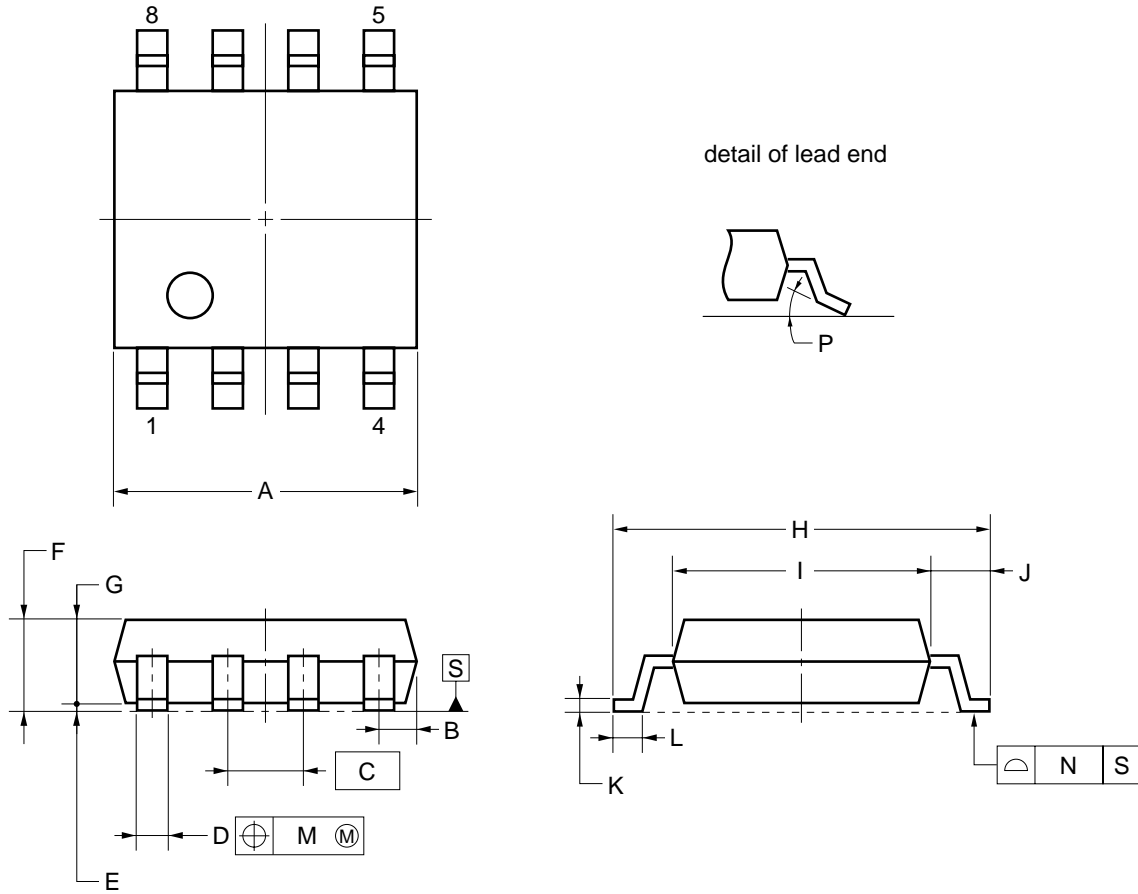

NOTE

Each lead centerline is located within 0.12 mm of its true position (T.P.) at maximum material condition.

ITEM	MILLIMETERS
A	5.2 ^{+0.17} / _{-0.20}
B	0.78 MAX.
C	1.27 (T.P.)
D	0.42 ^{+0.08} / _{-0.07}
E	0.1±0.1
F	1.59±0.21
G	1.49
H	6.5±0.3
I	4.4±0.15
J	1.1±0.2
K	0.17 ^{+0.08} / _{-0.07}
L	0.6±0.2
M	0.12
N	0.10
P	3° ^{+7°} / _{-3°}

S8GM-50-225B-6

3-PIN PLASTIC SIP (TO-92)

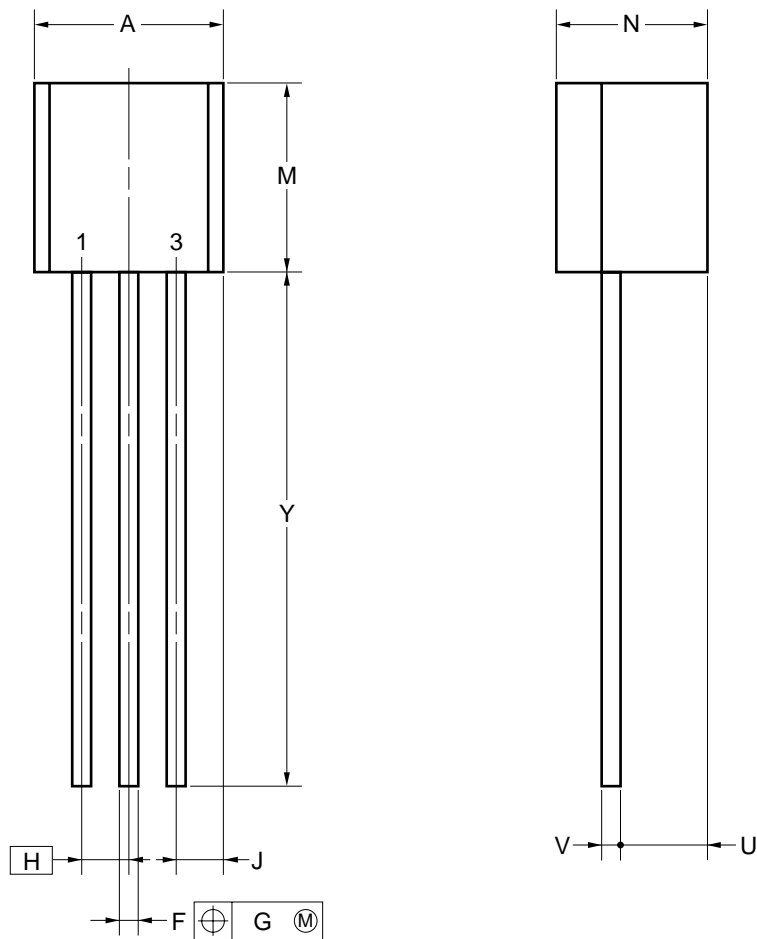

NOTE

Each lead centerline is located within 0.12 mm of its true position (T.P.) at maximum material condition.

ITEM	MILLIMETERS
A	5.0±0.2
F	0.50 ^{+0.30} _{-0.10}
G	0.12
H	1.27
J	1.33 MAX.
M	5.0±0.5
N	4.0±0.2
U	2.8 MAX.
V	0.50±0.10
Y	15.0±0.7

P3J-127B-3

RECOMMENDED SOLDERING CONDITIONS

When soldering these products, there are highly recommended to observe the conditions as shown below.

If other soldering processes are used, or if the soldering is performed under different conditions, please make sure to consult with our sales offices.

For more details, refer to our document “**Semiconductor Device Mounting Technology Manual**” (C10535E).

Type of Surface Mount Device

★ **μ PC1943T, 1944T : Power mini mold (SOT-89)**

Process	Conditions	Symbol
Infrared ray reflow	Peak temperature: 235 °C or below (Package surface temperature), Reflow time: 30 seconds or less (at 210 °C or higher), Maximum number of reflow processes: 2 times.	IR35-00-2
VPS	Peak temperature: 215 °C or below (Package surface temperature), Reflow time: 40 seconds or less (at 200 °C or higher), Maximum number of reflow processes: 2 times.	VP15-00-2
Wave soldering	Solder temperature: 260 °C or below, Flow time: 10 seconds or less, Maximum number of flow processes: 1 time, Pre-heating temperature: 120 °C or below (Package surface temperature).	WS60-00-1

Caution Apply only one kind of soldering condition to a device, or the device will be damaged by heat stress.

★ **μ PC1944GR : 8-pin plastic SOP (5.72 mm (225))**

Process	Conditions	Symbol
Infrared ray reflow	Peak temperature: 235 °C or below (Package surface temperature), Reflow time: 30 seconds or less (at 210 °C or higher), Maximum number of reflow processes: 1 time.	IR35-00-1
VPS	Peak temperature: 215 °C or below (Package surface temperature), Reflow time: 40 seconds or less (at 200 °C or higher), Maximum number of reflow processes: 1 time.	VP15-00-1
Wave soldering	Solder temperature: 260 °C or below, Flow time: 10 seconds or less, Maximum number of flow processes: 1 time, Pre-heating temperature: 120 °C or below (Package surface temperature).	WS60-00-1

Caution Apply only one kind of soldering condition to a device, or the device will be damaged by heat stress.

Type of Through-hole Device

★ **μ PC1944J : 3-pin plastic SIP (TO-92)**

Process	Conditions
Wave soldering (only to leads)	Solder temperature: 260 °C or below, Flow time: 10 seconds or less.

Caution For through-hole device, the wave soldering process must be applied only to leads, and make sure that the package body does not get jet soldered.

★ **REMARK OF THE PACKAGE MARK**

The package marks of the μPC1943T and the μPC1944T are the symbols as follows.

Part Number	Mark
μPC1943T	9B
μPC1944T	9C

REFERENCE DOCUMENTS

Semiconductor Device Mounting Technology Manual	C10535E
Semiconductor Selection Guide -Products and Packages-	X13769X

[MEMO]

[MEMO]

- **The information in this document is subject to change without notice. Before using this document, please confirm that this is the latest version.**
 - No part of this document may be copied or reproduced in any form or by any means without the prior written consent of NEC Corporation. NEC Corporation assumes no responsibility for any errors which may appear in this document.
 - NEC Corporation does not assume any liability for infringement of patents, copyrights or other intellectual property rights of third parties by or arising from use of a device described herein or any other liability arising from use of such device. No license, either express, implied or otherwise, is granted under any patents, copyrights or other intellectual property rights of NEC Corporation or others.
 - Descriptions of circuits, software, and other related information in this document are provided for illustrative purposes in semiconductor product operation and application examples. The incorporation of these circuits, software, and information in the design of the customer's equipment shall be done under the full responsibility of the customer. NEC Corporation assumes no responsibility for any losses incurred by the customer or third parties arising from the use of these circuits, software, and information.
 - While NEC Corporation has been making continuous effort to enhance the reliability of its semiconductor devices, the possibility of defects cannot be eliminated entirely. To minimize risks of damage or injury to persons or property arising from a defect in an NEC semiconductor device, customers must incorporate sufficient safety measures in its design, such as redundancy, fire-containment, and anti-failure features.
 - NEC devices are classified into the following three quality grades:
"Standard", "Special", and "Specific". The Specific quality grade applies only to devices developed based on a customer designated "quality assurance program" for a specific application. The recommended applications of a device depend on its quality grade, as indicated below. Customers must check the quality grade of each device before using it in a particular application.
 - Standard: Computers, office equipment, communications equipment, test and measurement equipment, audio and visual equipment, home electronic appliances, machine tools, personal electronic equipment and industrial robots
 - Special: Transportation equipment (automobiles, trains, ships, etc.), traffic control systems, anti-disaster systems, anti-crime systems, safety equipment and medical equipment (not specifically designed for life support)
 - Specific: Aircraft, aerospace equipment, submersible repeaters, nuclear reactor control systems, life support systems or medical equipment for life support, etc.
- The quality grade of NEC devices is "Standard" unless otherwise specified in NEC's Data Sheets or Data Books. If customers intend to use NEC devices for applications other than those specified for Standard quality grade, they should contact an NEC sales representative in advance.