

2543

PROTECTED QUAD POWER DRIVER

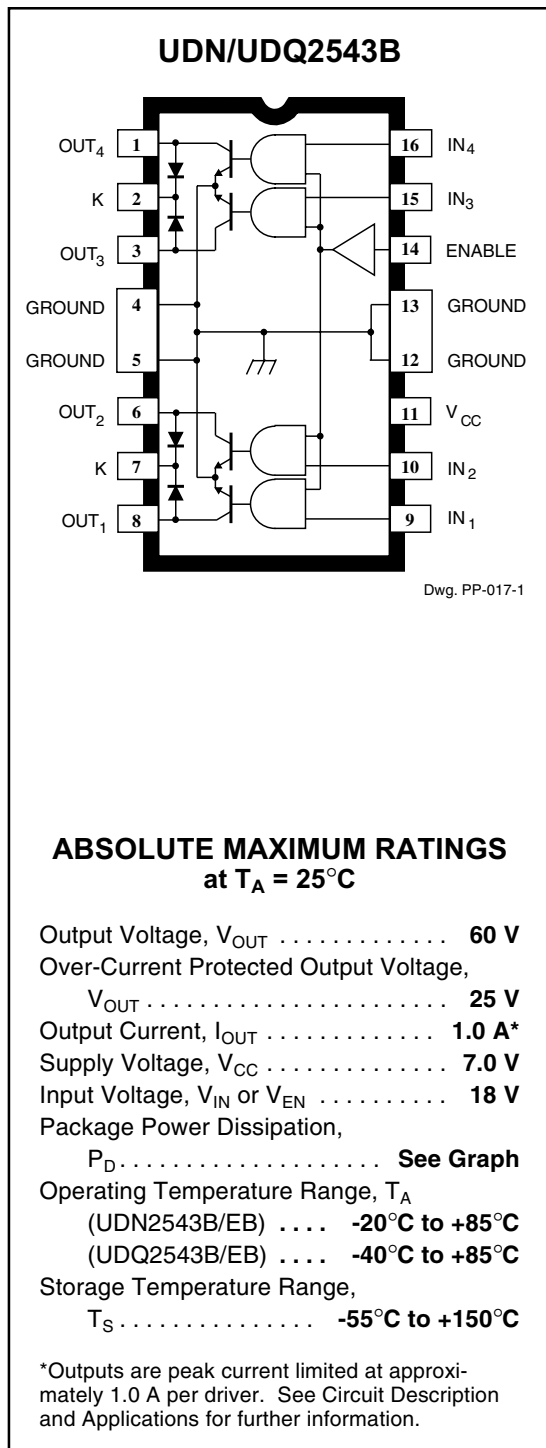

Providing interface between low-level logic and power loads to 100 W, the UDx2543B and UDx2543EB quad power drivers combine AND logic gates and high-current bipolar outputs. Each of the four independent outputs can sink up to 700 mA in the ON state. The outputs have a minimum breakdown voltage (load dump) of 60 V and a sustaining voltage of 35 V. The inputs are compatible with most TTL, DTL, LSTTL, and 5 V CMOS and PMOS logic systems.

Over-current protection has been designed into each channel of the UDx2543B/EB and typically occurs at 1 A. It protects any one channel from output short circuits with supply voltages up to 25 V. When the maximum output current is reached, that output stage is driven linearly. If the over-current condition continues, that output's thermal limiting will operate, limiting that output's power dissipation to approximately 2.4 W. The outputs also include diodes for voltage clamping with inductive loads such as relays, solenoids, or dc stepper motors.

These devices are supplied in a 16-pin power DIP of batwing construction (suffix 'B') to provide for maximum package power dissipation. They are also available in a 28-lead PLCC (suffix 'EB') for surface-mount applications. All devices are rated for continuous operation over the temperature range of -20°C to +85°C (UDN2543B/EB) or for use in automotive applications over an extended temperature range as the UDQ2543B/EB.

FEATURES

- 700 mA Output Current per Channel
- Low Output-Saturation Voltage
- Integral Output Transient-Suppression Diodes
- TTL, CMOS, PMOS, NMOS Compatible Inputs
- Independent Over-Current Protection for Each Output

Always order by complete part number:

Part Number	Package	Operating Temperature
UDN2543B	16-Pin DIP	-20°C to +85°C
UDN2543EB	28-Lead PLCC	-20°C to +85°C
UDQ2543B	16-Pin DIP	-40°C to +85°C
UDQ2543EB	28-Lead PLCC	-40°C to +85°C

2543 PROTECTED QUAD POWER DRIVER

FUNCTIONAL BLOCK DIAGRAM (1 OF 4 CHANNELS)

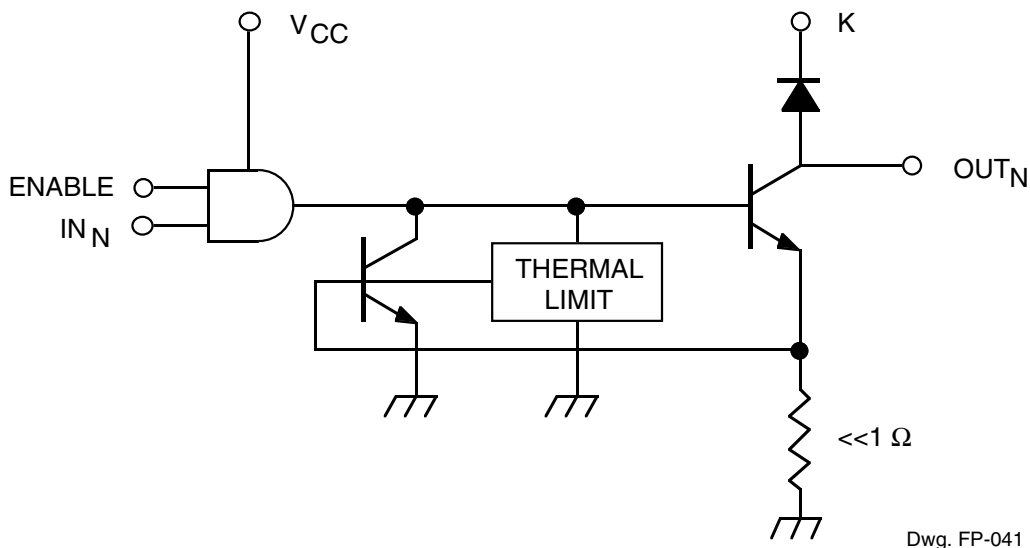

Dwg. FP-041

NOTE: These devices do not include an absolute thermal shutdown. Package power dissipation under fault conditions (2.4 W in the faulted channel) must therefore be evaluated at maximum operating temperature.

UDN/UDQ2543EB

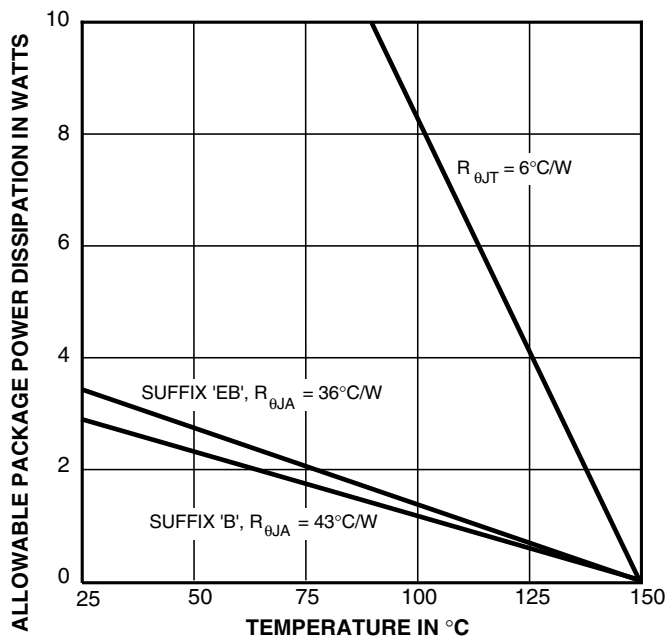

Dwg. GP-004-1A

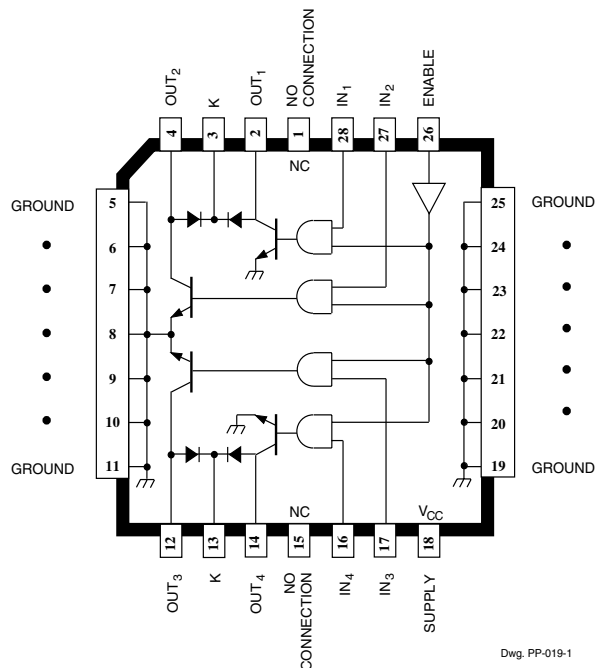

Dwg. PP-019-1



115 Northeast Cutoff, Box 15036
Worcester, Massachusetts 01615-0036 (508) 853-5000
Copyright © 1986, 1993, Allegro MicroSystems, Inc.

2543
PROTECTED
QUAD POWER DRIVER

ELECTRICAL CHARACTERISTICS at $T_A = +25^\circ\text{C}$ (UDN2543B/EB) or over operating temperature range (UDQ2543B/EB only), $V_{CC} = 4.75\text{ V}$ to 5.25 V

Characteristic	Symbol	Test Conditions	Limits		
			Min.	Max.	Units
Output Leakage Current	I_{CEX}	$V_{OUT} = 60\text{ V}, V_{IN} = 0.8\text{ V}, V_{EN} = 2.0\text{ V}$	—	100	μA
		$V_{OUT} = 60\text{ V}, V_{IN} = 2.0\text{ V}, V_{EN} = 0.8\text{ V}$	—	100	μA
Output Sustaining Voltage	$V_{OUT(SUS)}$	$I_{OUT} = 100\text{ mA}, V_{IN} = V_{EN} = 0.8\text{ V}$	35	—	V
Output Saturation Voltage	$V_{OUT(SAT)}$	$I_{OUT} = 100\text{ mA}, V_{IN} = V_{EN} = 2.0\text{ V}$	—	200	mV
		$I_{OUT} = 400\text{ mA}, V_{IN} = V_{EN} = 2.0\text{ V}$	—	400	mV
		$I_{OUT} = 700\text{ mA}, V_{IN} = V_{EN} = 2.0\text{ V}$	—	600	mV
Input Voltage	Logic 1	$V_{IN(1)}$ or $V_{EN(1)}$	2.0	—	V
	Logic 0	$V_{IN(0)}$ or $V_{EN(0)}$	—	0.8	V
Input Current	Logic 1	$V_{IN(1)}$ or $V_{EN(1)} = 2.0\text{ V}$	—	20	μA
	Logic 0	$V_{IN(0)}$ or $V_{EN(0)} = 0.8\text{ V}$	—	-10	μA
Total Supply Current	I_{CC}	$I_{OUT} = 700\text{ mA}^*, V_{IN}^\dagger = V_{EN} = 2.0\text{ V}$	—	65	mA
		Outputs Open, $V_{IN}^\dagger = 0.8\text{ V}, V_{EN} = 2.0\text{ V}$	—	15	mA
Clamp Diode Forward Voltage	V_F	$I_F = 1.0\text{ A}$	—	1.6	V
		$I_F = 1.5\text{ A}$	—	2.0	V
Clamp Diode Leakage Current	I_R	$V_R = 60\text{ V}, V_{IN} = V_{EN} = 2.0\text{ V},$ $D_1 + D_2$ or $D_3 + D_4$	—	50	μA

Negative current is defined as coming out of (sourcing) the specified terminal.

As used here, -100 is defined as greater than +10 (absolute magnitude convention) and the minimum is implicitly zero.

* Pulse test, allowable package power dissipation will be exceeded at increased ambient temperatures.

† All inputs simultaneously, all other tests are performed with each input tested separately.

2543 PROTECTED QUAD POWER DRIVER

TYPICAL OUTPUT BEHAVIOR

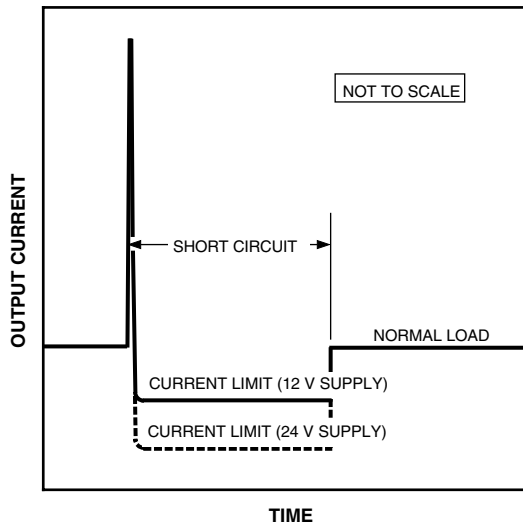

CIRCUIT DESCRIPTION AND APPLICATION

INCANDESCENT LAMP DRIVER

For incandescent lamp applications, the UDx2549B/EB or UDx2559B/EB, with improved shortcircuit protection and thermal limiting, are recommended.

INDUCTIVE LOAD DRIVER

Bifilar (unipolar) stepper motors, relays, or solenoids can be driven directly. The internal flyback diodes prevent damage to the output transistors by suppressing the high-voltage spikes that occur when turning OFF an inductive load. For rapid current decay (fast turn-OFF speeds), the use of Zener diodes will raise the flyback voltage and improve performance. However, the peak voltage must not exceed the specified minimum sustaining voltage ($V_{\text{SUPPLY}} + V_Z + V_F \leq V_{\text{OUT(SUS)}}$).

FAULT CONDITIONS

In the event of a shorted load, the load current will attempt to increase. As described above, the drive current to the affected output stage is diverted, causing the output stage to go linear, limiting the peak output current to approximately 1 A. As the power dissipation of that output stage increases, a thermal gradient sensing circuit will become operational, further decreasing the drive current to the affected output stage and reducing the output current to a value dependent on supply voltage ($I_{\text{OUT}} \approx 2.4/V_{\text{SUPPLY}}$). If the fault condition is corrected, the output stage will return to its normal saturated condition.

Due to the independent operation of the four channels, only a single channel should be shorted at a time. Multiple overload conditions may be tolerated provided rated package power dissipation is not exceeded.

2543 PROTECTED QUAD POWER DRIVER

UDN2543B and UDQ2543B Dimensions in Inches (controlling dimensions)

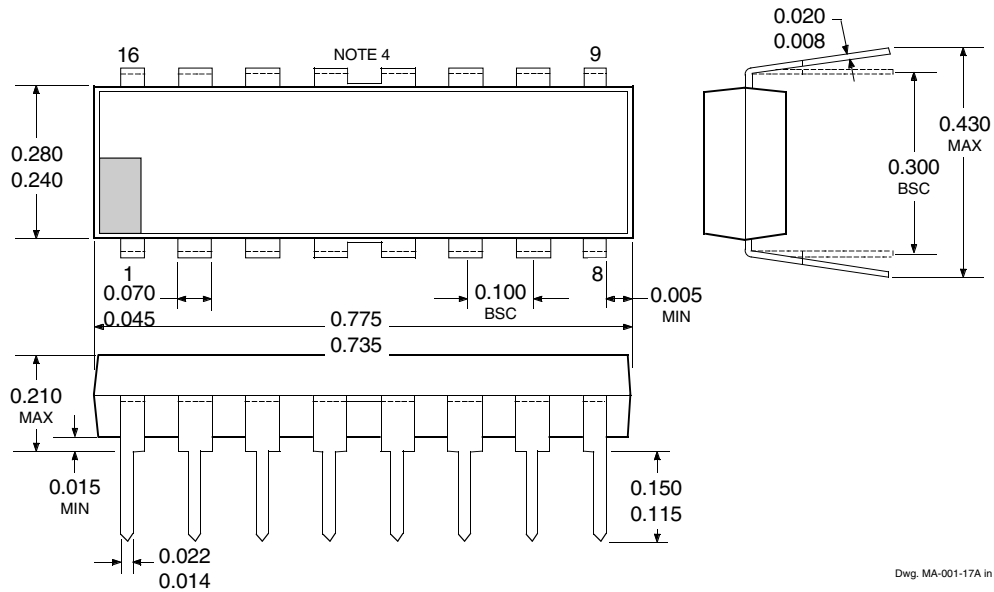

Dimensions in Millimeters (for reference only)

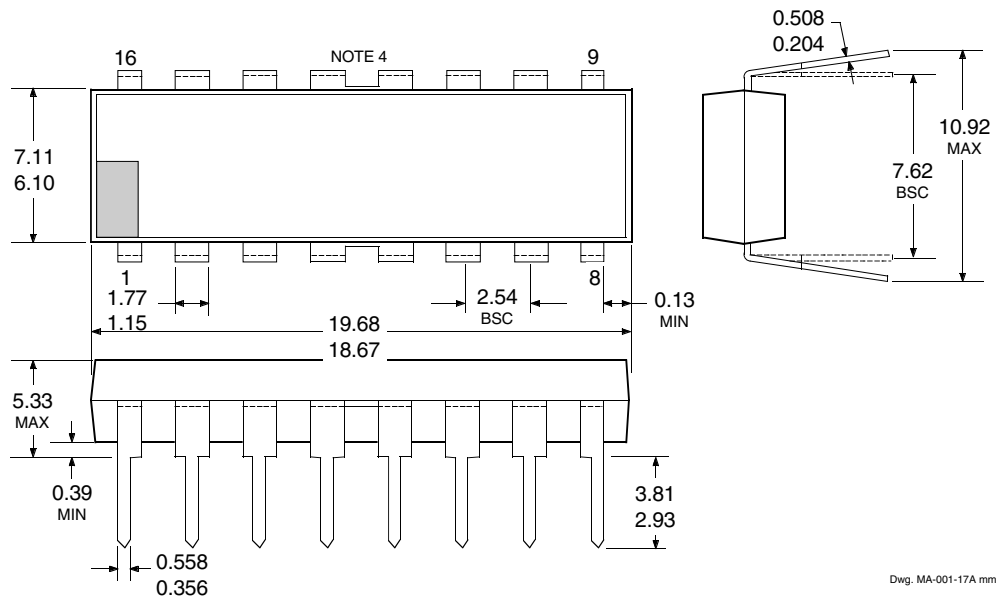

- NOTES: 1. Exact body and lead configuration at vendor's option within limits shown.
 2. Lead spacing tolerance is non-cumulative
 3. Lead thickness is measured at seating plane or below.
 4. Webbed lead frame. Leads 4, 5, 12, and 13 are internally one piece.

2543 PROTECTED QUAD POWER DRIVER

UDN2543EB and UDQ2543EB
Dimensions in Inches
(controlling dimensions)

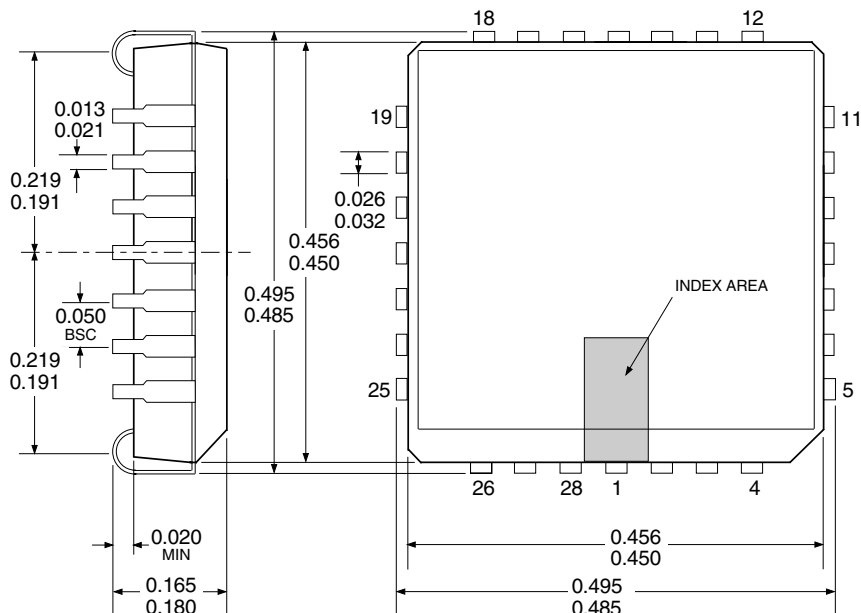

Dwg. MA-005-28A in

Dimensions in Millimeters
(for reference only)

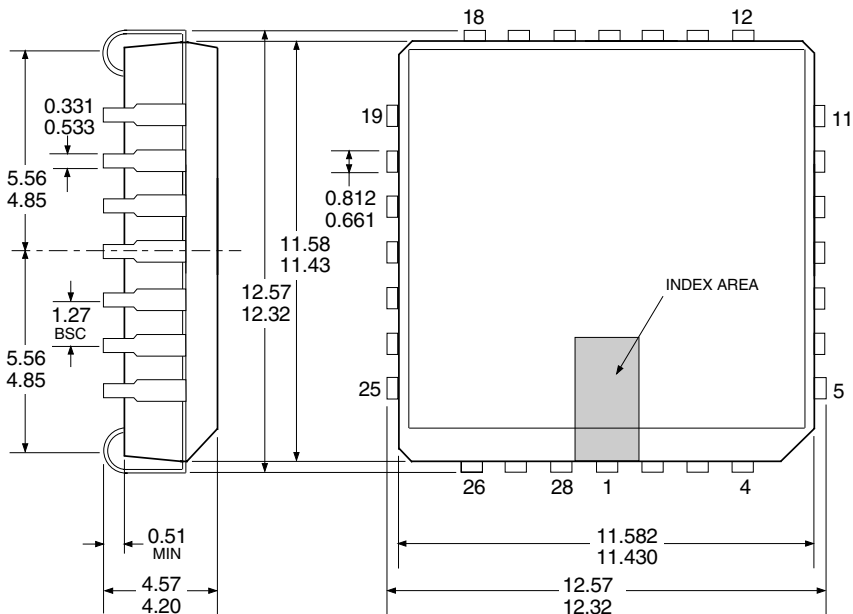

Dwg. MA-005-28A mm

- NOTES: 1. Exact body and lead configuration at vendor's option within limits shown.
2. Lead spacing tolerance is non-cumulative
3. Webbed lead frame. Leads 5 through 11 and 19 through 25 are internally one piece.



115 Northeast Cutoff, Box 15036
Worcester, Massachusetts 01615-0036 (508) 853-5000

2543
PROTECTED
QUAD POWER DRIVER

The products described here are manufactured under one or more U.S. patents or U.S. patents pending.

Allegro MicroSystems, Inc. reserves the right to make, from time to time, such departures from the detail specifications as may be required to permit improvements in the performance, reliability, or manufacturability of its products. Before placing an order, the user is cautioned to verify that the information being relied upon is current.

Allegro products are not authorized for use as critical components in life-support devices or systems without express written approval.

The information included herein is believed to be accurate and reliable. However, Allegro MicroSystems, Inc. assumes no responsibility for its use; nor for any infringement of patents or other rights of third parties which may result from its use.

2543 PROTECTED QUAD POWER DRIVER

POWER SINK DRIVERS

IN ORDER OF 1) OUTPUT CURRENT, 2) OUTPUT VOLTAGE, 3) NUMBER OF DRIVERS

Output Ratings *			Features					Part Number [†]	
mA	V	#	Serial Input	Latched Drivers	Diode Clamp	Outputs	Internal Protection		
75	17	8	X	X	–	constant current	–	6275	
	17	16	X	X	–	constant current	–	6276	
100	20	8	–	–	–	saturated	–	2595	
	30	32	X	X	–	–	–	5833	
	40	32	X	X	–	saturated	–	5832	
	50	8	–	addressable decoder/driver		DMOS	–	6B259	
	50	8	–	X	–	DMOS	–	6B273	
	50	8	X	X	–	DMOS	–	6B595	
250	50	8	–	addressable decoder/driver		DMOS	–	6259	
	50	8	–	X	–	DMOS	–	6273	
	50	8	X	X	–	DMOS	–	6595	
	135	7	–	–	X	–	–	7003	
300	45	1	–	Hall sensor/driver		X	–	5140	
	50	7	–	–	X	–	–	2003	
	50	8	–	–	X	–	–	2803	
	50	8	–	–	X	saturated	–	2596	
	60	4	–	–	X	saturated	X	2557	
	95	7	–	–	X	–	–	2023	
	95	8	–	–	X	–	–	2823	
	350	50	4	–	X	X	–	–	5800
50		7	–	–	X	–	–	2004	
50		8	–	–	X	–	–	2804	
50		8	–	X	X	–	–	5801	
50		8	X	X	–	–	–	5821	
50		8	X	X	X	–	–	5841	
50		8	–	addressable decoder/driver		DMOS	–	6A259	
50		8	X	X	–	DMOS	–	6A595	
80		8	X	X	–	–	–	5822	
80		8	X	X	X	–	–	5842	
95		7	–	–	X	–	–	2024	
95		8	–	–	X	–	–	2824	
450		30	28	dual 4- to 14-line decoder/driver			–	–	6817
600	60	4	–	–	–	saturated	X	2547	
	60	4	–	–	X	saturated	X	2549	
700	60	4	–	–	X	saturated	X	2543 and 2559	
750	50	8	–	–	X	saturated	–	2597	
900	14	2	–	Hall sensor/driver		X	saturated	X	3625
	26	2	–	Hall sensor/driver		X	saturated	X	3626
1000	46	4	stepper motor controller/driver			MOS	–	7024 and 7029	
1200	46	4	microstepping controller/driver			MOS	–	7042	
1250	50	4	stepper motor translator/driver			–	X	5804	
	50	4	–	–	X	–	–	2064 and 2068	
1500	80	4	–	–	X	–	–	2065 and 2069	
1800	50	4	–	–	X	–	–	2544	
	50	4	–	–	X	–	–	2540	
3000	46	4	stepper motor controller/driver			MOS	–	7026	
	46	4	microstepping controller/driver			MOS	–	7044	
4000	50	4	–	–	X	–	–	2878	
	80	4	–	–	X	–	–	2879	

* Current is maximum specified test condition, voltage is maximum rating. See specification for sustaining voltage limits or over-current protection voltage limits.

† Complete part number includes additional characters to indicate operating temperature range and package style.



115 Northeast Cutoff, Box 15036
Worcester, Massachusetts 01615-0036 (508) 853-5000