

## Silicon PIN Photodiode, RoHS Compliant

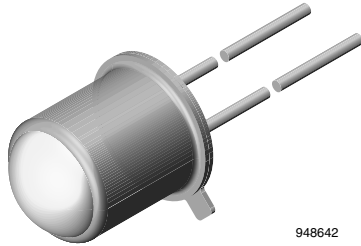

948642

### DESCRIPTION

BPW24R is a high sensitive silicon planar photodiode in a standard TO-18 hermetically sealed metal case with a glass lens.

A precise alignment of the chip gives a good coincidence of mechanical and optical axes. The device features a low capacitance and high speed even at low supply voltages.

### FEATURES

- Package type: leaded
- Package form: TO-18
- Dimensions (in mm): Ø 4.7
- Radiant sensitive area (in mm<sup>2</sup>): 0.78
- High photo sensitivity
- High radiant sensitivity
- Suitable for visible and near infrared radiation
- Fast response times
- Angle of half sensitivity:  $\varphi = \pm 12^\circ$
- Hermetically sealed package
- Cathode connected to package
- Central chip alignment
- Lead (Pb)-free component in accordance with RoHS 2002/95/EC and WEEE 2002/96/EC



**RoHS**  
COMPLIANT

### APPLICATIONS

- High speed photo detector

PRODUCT SUMMARY			
COMPONENT	$I_{ra}$ (µA)	$\varphi$ (deg)	$\lambda_{0.5}$ (nm)
BPW24R	60	$\pm 12$	600 to 1050

**Note**

Test condition see table “Basic Characteristics”

ORDERING INFORMATION			
ORDERING CODE	PACKAGING	REMARKS	PACKAGE FORM
BPW24R	Bulk	MOQ: 1000 pcs, 1000 pcs/bulk	TO-18

**Note**

MOQ: minimum order quantity

ABSOLUTE MAXIMUM RATINGS				
PARAMETER	TEST CONDITION	SYMBOL	VALUE	UNIT
Reverse voltage		$V_R$	60	V
Power dissipation	$T_{amb} \leq 25^\circ\text{C}$	$P_V$	210	mW
Junction temperature		$T_j$	125	°C
Operating temperature range		$T_{amb}$	- 40 to + 125	°C
Storage temperature range		$T_{stg}$	- 40 to + 125	°C
Soldering temperature	$t \leq 5$ s	$T_{sd}$	260	°C
Thermal resistance junction/ambient	Connected with Cu wire, 0.14 mm <sup>2</sup>	$R_{thJA}$	350	K/W

**Note**

$T_{amb} = 25^\circ\text{C}$ , unless otherwise specified

BASIC CHARACTERISTICS						
PARAMETER	TEST CONDITION	SYMBOL	MIN.	TYP.	MAX.	UNIT
Breakdown voltage	$I_R = 100 \mu A, E = 0$	$V_{(BR)}$	60	200		V
Reverse dark current	$V_R = 50 V, E = 0$	$I_{ro}$		2	10	nA
Diode capacitance	$V_R = 0 V, f = 1 MHz, E = 0$	$C_D$		11		pF
	$V_R = 5 V, f = 1 MHz, E = 0$	$C_D$		3.8		pF
	$V_R = 20 V, f = 1 MHz, E = 0$	$C_D$		2.5		pF
Open circuit voltage	$E_e = 1 mW/cm^2, \lambda = 950 nm$	$V_o$		450		mV
Temperature coefficient of $V_o$	$E_e = 1 mW/cm^2, \lambda = 950 nm$	$TK_{V_o}$		-2		mV/K
Short circuit current	$E_e = 1 mW/cm^2, \lambda = 950 nm$	$I_k$		55		$\mu A$
Temperature coefficient of $I_k$	$E_A = 1 klx$	$TK_{I_k}$		0.1		%/K
Reverse light current	$E_e = 1 mW/cm^2, \lambda = 950 nm, V_R = 20 V$	$I_{ra}$	45	60		$\mu A$
Absolute Spectral Sensitivity	$V_R = 5 V, \lambda = 870 nm$	$s(\lambda)$		0.60		A/W
	$V_R = 5 V, \lambda = 900 nm$	$s(\lambda)$		0.55		A/W
Angle of half sensitivity		$\phi$		$\pm 12$		deg
Wavelength of peak sensitivity		$\lambda_p$		900		nm
Range of spectral bandwidth		$\lambda_{0.5}$		600 to 1050		nm
Rise time	$V_R = 20 V, R_L = 50 \Omega, \lambda = 820 nm$	$t_r$		7		ns
Fall time	$V_R = 20 V, R_L = 50 \Omega, \lambda = 820 nm$	$t_f$		7		ns

**Note**

$T_{amb} = 25 \text{ }^\circ C$ , unless otherwise specified

**BASIC CHARACTERISTICS**

$T_{amb} = 25 \text{ }^\circ C$ , unless otherwise specified

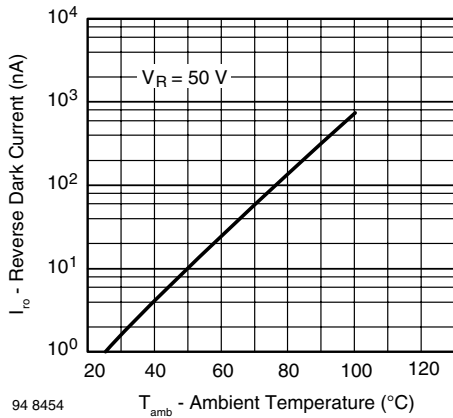

Fig. 1 - Reverse Dark Current vs. Ambient Temperature

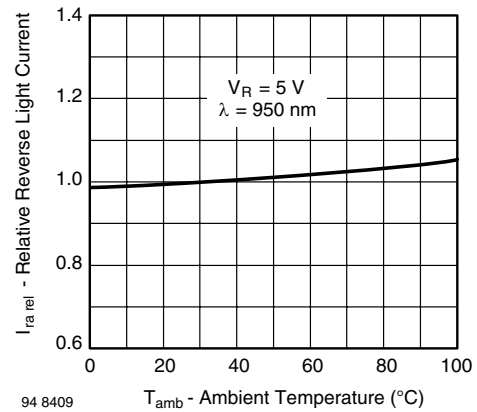

Fig. 2 - Relative Reverse Light Current vs. Ambient Temperature

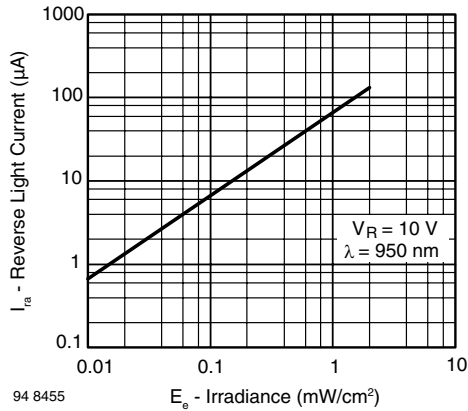

Fig. 3 - Reverse Light Current vs. Irradiance

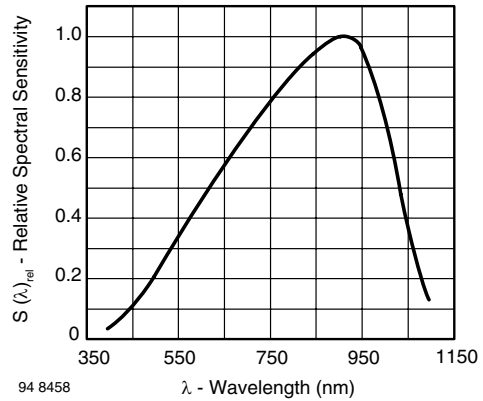

Fig. 6 - Relative Spectral Sensitivity vs. Wavelength

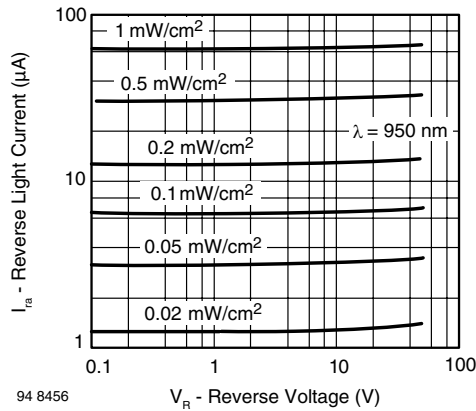

Fig. 4 - Reverse Light Current vs. Reverse Voltage

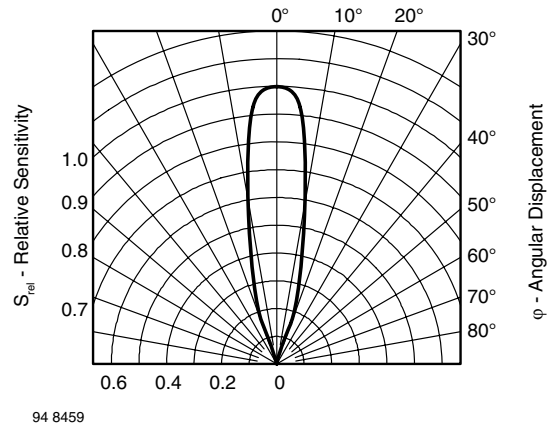

Fig. 7 - Relative Radiant Sensitivity vs. Angular Displacement

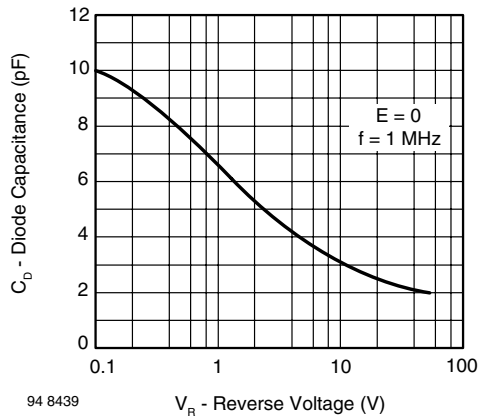
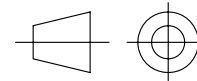
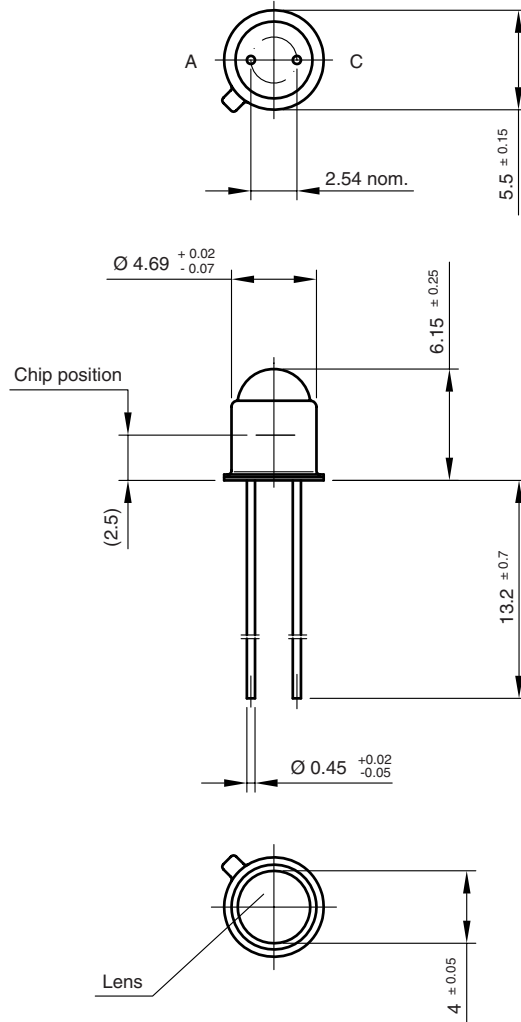

Fig. 5 - Diode Capacitance vs. Reverse Voltage

**PACKAGE DIMENSIONS** in millimeters



technical drawings  
according to DIN  
specifications

Drawing-No.: 6.503-5022.02-4

Issue: 1; 24.08.98

14487



## Disclaimer

All product specifications and data are subject to change without notice.

Vishay Intertechnology, Inc., its affiliates, agents, and employees, and all persons acting on its or their behalf (collectively, "Vishay"), disclaim any and all liability for any errors, inaccuracies or incompleteness contained herein or in any other disclosure relating to any product.

Vishay disclaims any and all liability arising out of the use or application of any product described herein or of any information provided herein to the maximum extent permitted by law. The product specifications do not expand or otherwise modify Vishay's terms and conditions of purchase, including but not limited to the warranty expressed therein, which apply to these products.

No license, express or implied, by estoppel or otherwise, to any intellectual property rights is granted by this document or by any conduct of Vishay.

The products shown herein are not designed for use in medical, life-saving, or life-sustaining applications unless otherwise expressly indicated. Customers using or selling Vishay products not expressly indicated for use in such applications do so entirely at their own risk and agree to fully indemnify Vishay for any damages arising or resulting from such use or sale. Please contact authorized Vishay personnel to obtain written terms and conditions regarding products designed for such applications.

Product names and markings noted herein may be trademarks of their respective owners.