



Pb-free
HEAT



VLW1148LS

PLCC-2 Type White LED
(High Reliability type, White V-Series)

Features

Package	PLCC-2 Type, Diffused pale yellow resin
Product features	<ul style="list-style-type: none">• Outer Dimension 2.17 x 1.4 x 1.3mm(L x W x H)• Wide operation temperature range. Storage Temperature : -40°C~110°C Operating Temperature : -40°C~100°C Operation Guarantee• Spatial distribution characteristics. (2θ 1/2 : 120deg)• Corresponding to a use requiring high reliability in cars etc...• Lead-free soldering compatible• RoHS compliant
Chromaticity coordinates	x = 0.31TYP., y = 0.32TYP. (Condition : I _f =10mA)
Spatial distribution	120 deg.
Die materials	InGaN
Optical efficiency	10.0lm/W
Rank grouping parameter	Sorted by luminous intensity and chromaticity per rank taping
Assembly method	Auto pick & place machine (Auto Mounter)
Soldering methods	Reflow soldering and manual soldering
Taping and reel	3,000pcs per reel in a 8mm width tape. (Standard) Reel diameter : φ 180mm
ESD	1kV (HBM)

Recommended Applications

SW lighting for car indicators, meter panel, car audio and heater control, etc...



VLW1148LS

PLCC-2 Type White LED
(High Reliability type, White V-Series)

Color and Luminous Intensity

(Ta=25°C)

Part No.	Material	Emitted Color	Lens Color	Luminous Intensity			Luminous Flux	
				I _v (mcd)			φ _v (lm)	
				MIN.	TYP.	I _F	TYP.	I _F
VLW1148LS	InGaN	White	Pale Yellow	47	100	10	0.31	10

※Note : The above luminous intensity(I_v) is the setup values of the sorting machine.
(Tolerance : I_v...±10%)

Absolute Maximum Ratings

(Ta=25°C)

Item	Symbol	Absolute Maximum Ratings	Unit
Power Dissipation	P_d	78	mW
Forward Current	I_F	20	mA
Pulse Forward Current ※1	I_{FRM}	100	mA
Derating (Ta=60°C or higher)	ΔI_F	0.40	mA/°C
	ΔI_{FRM}	2	mA/°C
Reverse Voltage	V_R	5	V
Operating Temperature	T_{opr}	-40~+100	°C
Storage Temperature	T_{stg}	-40~+110	°C

 ※1 I_{FRM} Measurement condition : Pulse Width ≤ 1 ms, Duty $\leq 1/10$

Thermal Characteristics

Item	Symbol	Ratings	Unit
Junction Temperature (MAX.)	T_j	110	°C
Thermal Resistance (TYP.) (Junction/ ambient)	$R_{(th\ j-a)}$	350	°C/W
Thermal Resistance (TYP.) (Junction/ Solder Point)	$R_{(th\ j-s)}$	200	°C/W

 ※Rth(j-a) Measurement Condition / Substrate: FR4(t=1.6mm) Pattern Size: 16mm².

Electro-Optical Characteristics

(Ta=25°C)

Item	Condition	Symbol	Characteristics		Unit
Forward Voltage	I _F =10mA	V _F	TYP.	3.1	V
			MAX.	3.7	
Reverse Current	V _R =5V	I _R	MAX.	10	μA
Half Intensity Angle	I _F =10mA	2θ 1/2	TYP.	120	deg.
Chromaticity Coordinates	I _F =10mA	x	TYP.	0.31	-
		y	TYP.	0.32	-

Luminous Intensity Rank

(Ta=25°C)

Intensity Tolerance each Rank : +/-10%

Rank	I _v (mcd)		Condition
	MIN.	MAX.	
B9	47	56	I_f=10mA
BX	56	68	
BY	68	82	
BZ	82	100	
C1	100	120	
C2	120	150	
C3	150	180	

Please contact our sales staff concerning rank designation.

Sorting Chart for Chromaticity Coordinates

Chromaticity Coordinates Tolerance Each Rank : +/-0.01

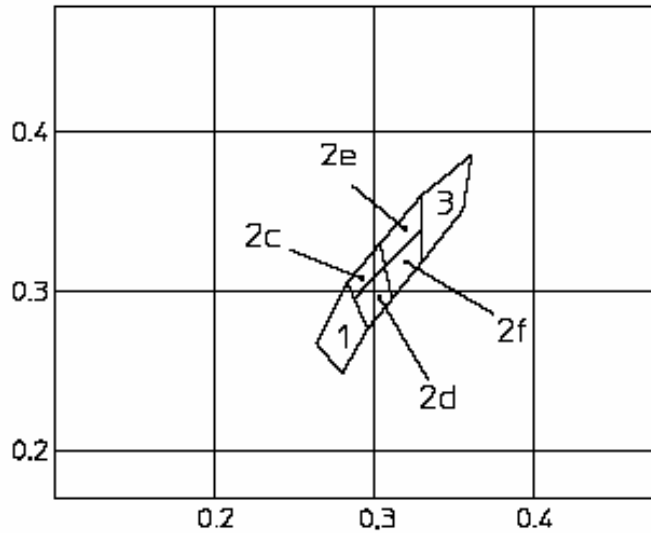
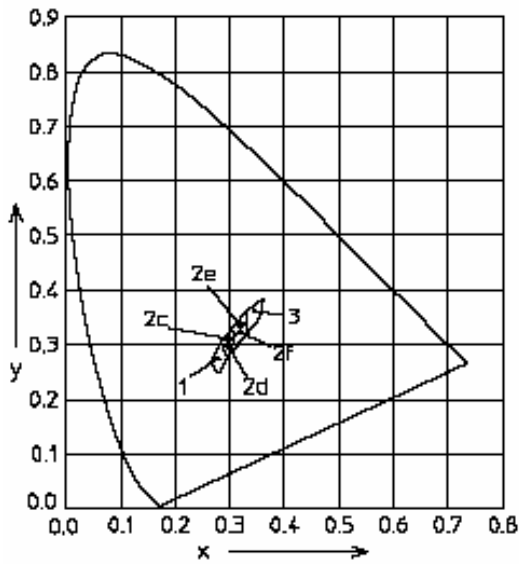

Rank	LEFT DOWN point		LEFT UP point		RIGHT UP point		RIGHT UP point	
	x	y	x	y	x	y	x	y
1	0.280	0.248	0.264	0.267	0.283	0.305	0.296	0.276
2c	0.287	0.295	0.283	0.305	0.304	0.330	0.307	0.315
2d	0.296	0.276	0.287	0.295	0.307	0.315	0.311	0.294
2e	0.307	0.315	0.304	0.330	0.330	0.360	0.330	0.339
2f	0.311	0.294	0.307	0.315	0.330	0.339	0.330	0.318
3	0.330	0.318	0.330	0.360	0.361	0.385	0.356	0.351

Please contact our sales staff concerning rank designation.

Technical Data

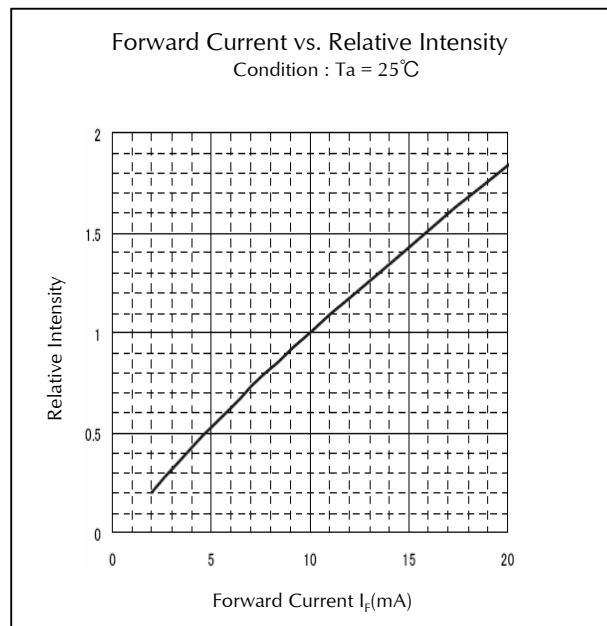
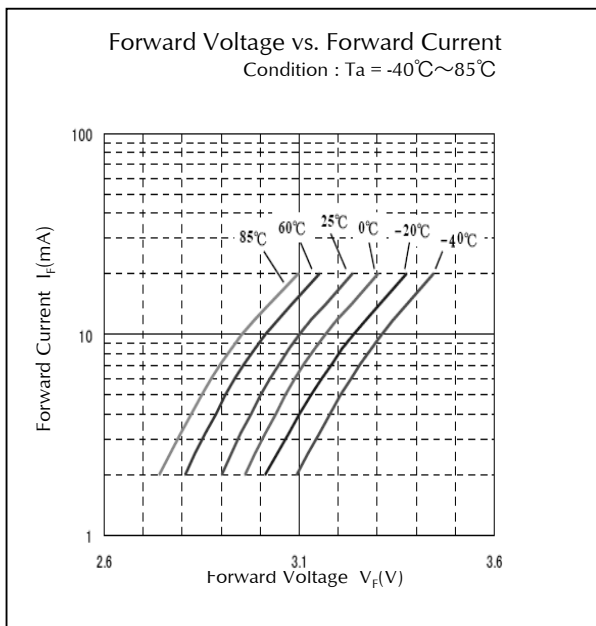
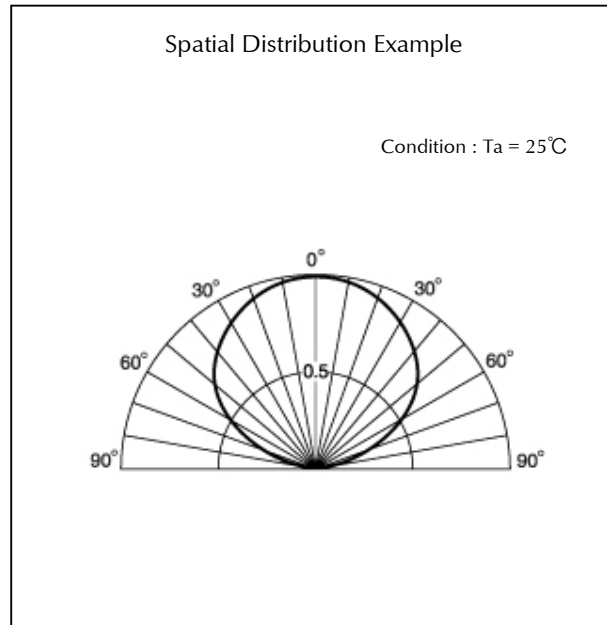
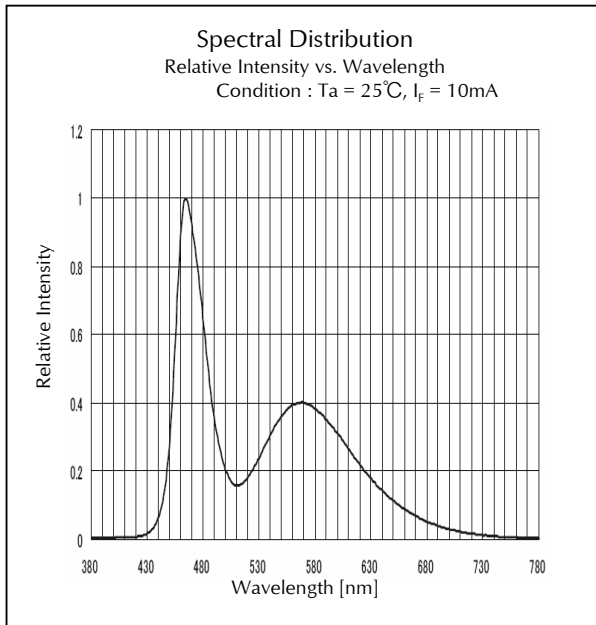

Technical Data

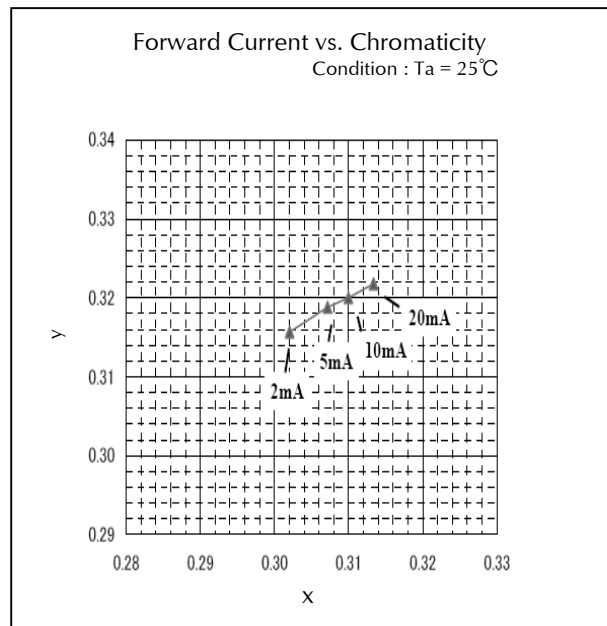
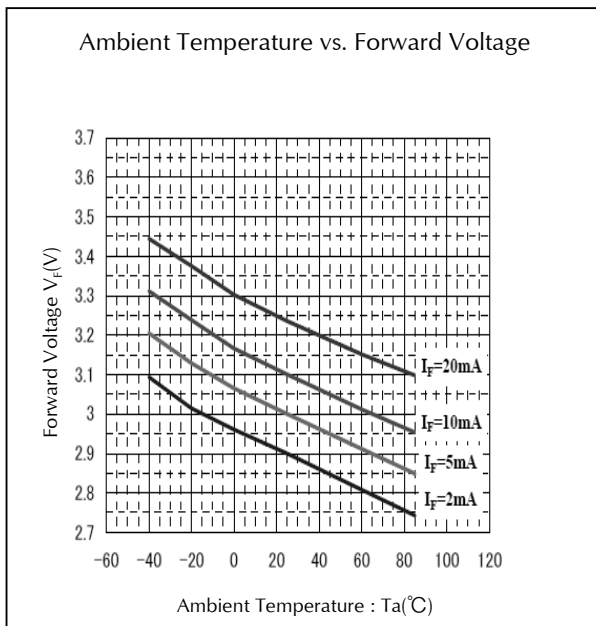
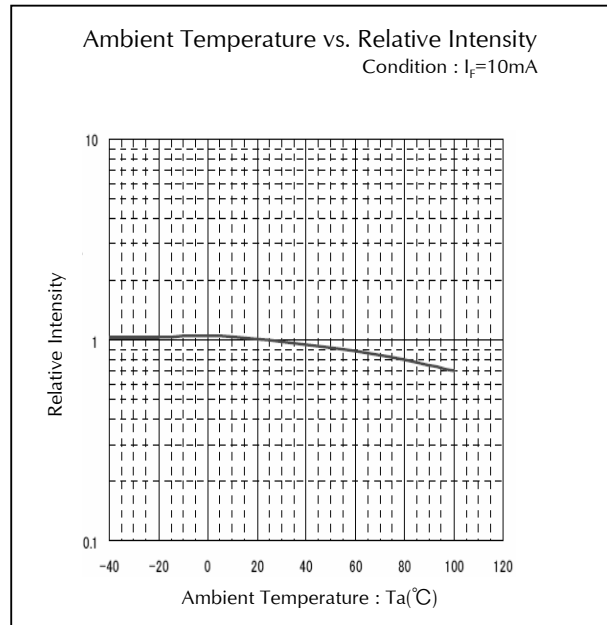
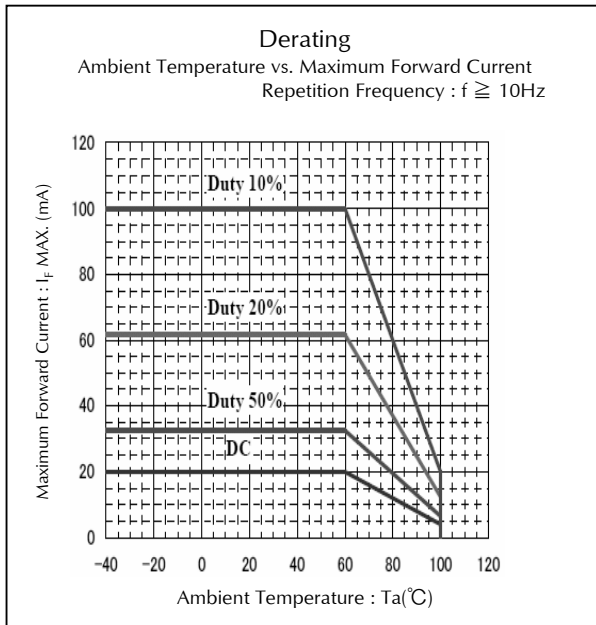

Technical Data

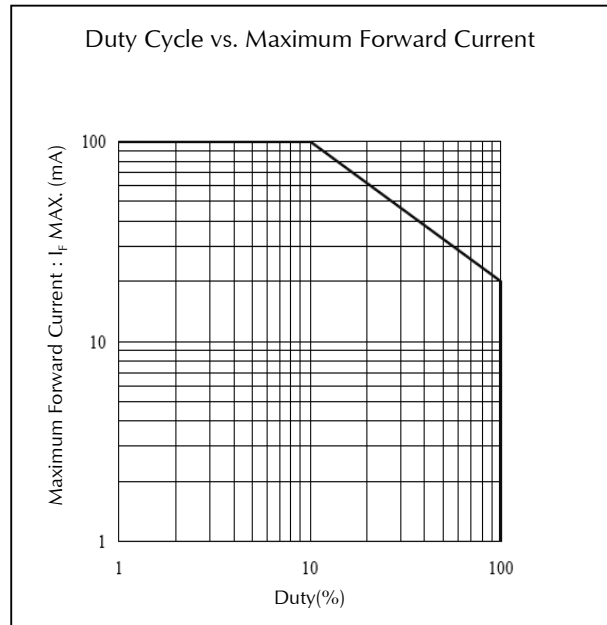
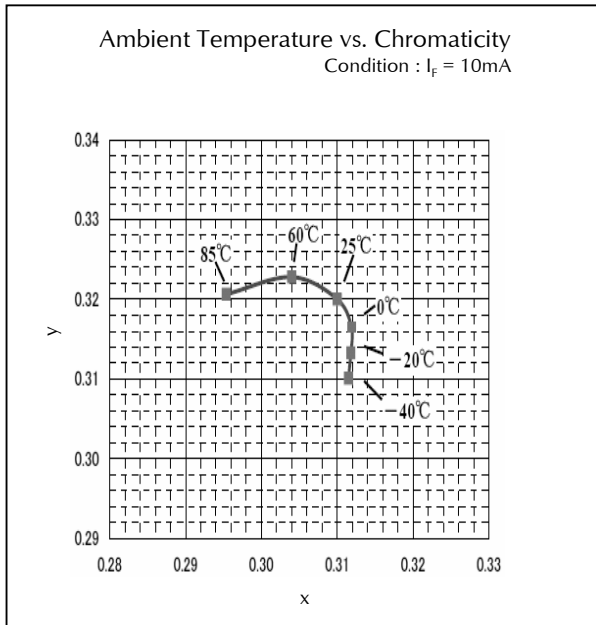

Package Dimensions

(Unit: mm)

Weight: (8.0)mg

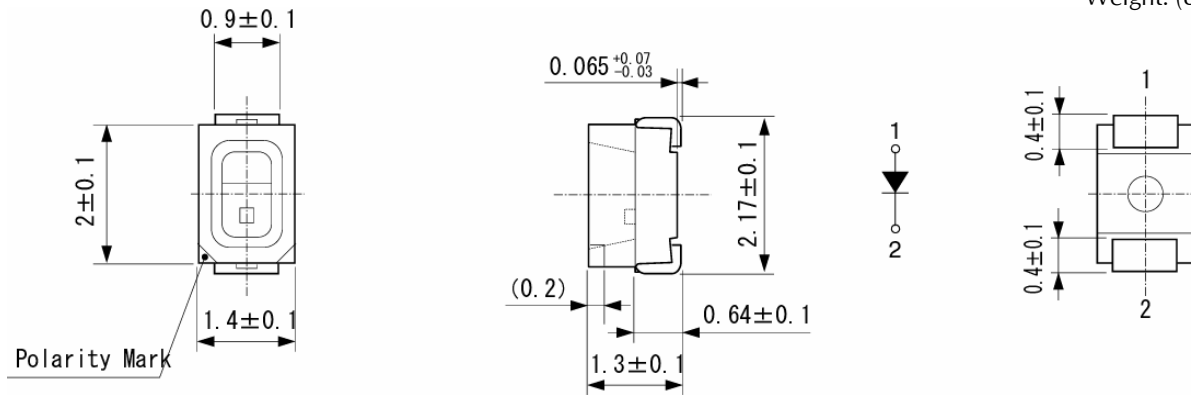

Recommended Soldering Pattern

(Unit: mm)

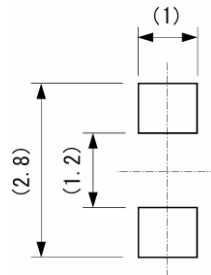

Taping Specification

(Unit: mm)

•Quantity: 3,000pcs/ reel (standard)

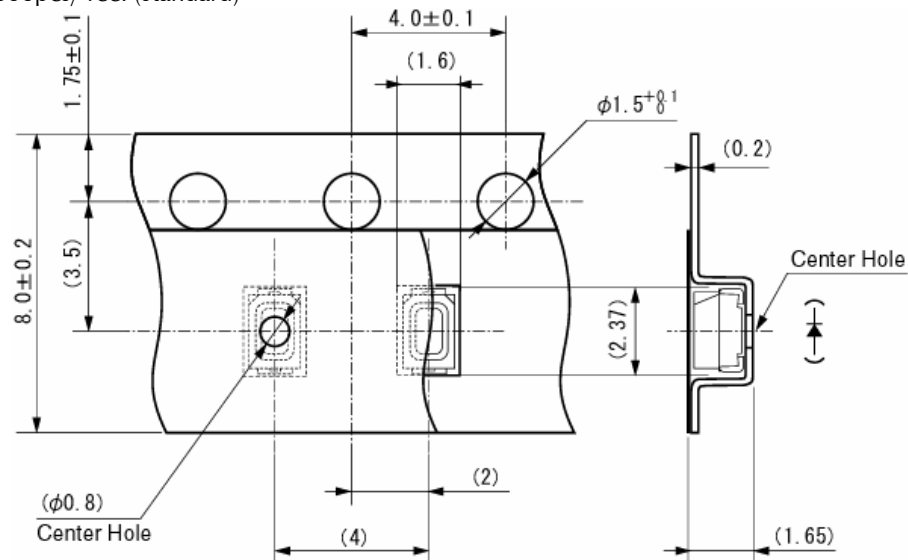

Reflow Soldering Conditions

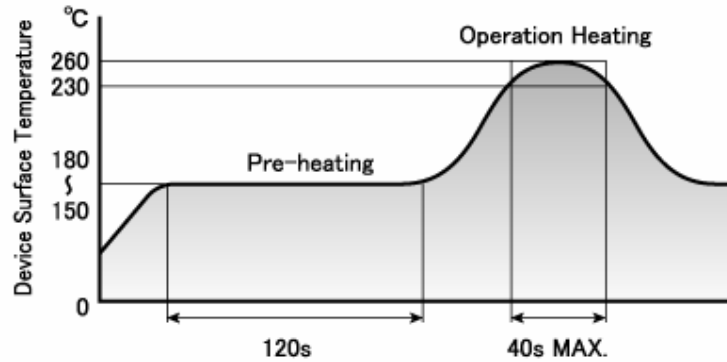

- 1) The above profile temperature gives the maximum temperature of the LED resin surface. Please set the temperature so as to avoid exceeding this range.
- 2) Total times of reflow soldering process shall be no more than 2 times. When the second reflow soldering process is performed, intervals between the first and second reflow should be short as possible (while allowing some time for the component to return to room temperature after the first reflow) in order to prevent the LED resin from absorbing moisture.
- 3) Temperature fluctuation to the LED during the pre-heating process shall be minimized. (6°C maximum)

Manual Soldering Conditions

Iron tip temp.	350 °C	(MAX.)
Soldering time and frequency	3 s	(MAX.)
	1 time	(MAX.)

Reliability Testing Result

Reliability Testing Result	Applicable Standard	Testing Conditions	Duration	Failure
Room Temp. Operating Life	EIAJ ED-4701/100(101)	Ta = 25°C, If = 20mA	1,000 h	0/20
High Temp. Operating Life	EIAJ ED-4701/100(101)	Ta = 85°C, If = 10mA	1,000 h	0/20
Low Temp. Operating Life	EIAJ ED-4701/100(101)	Ta = -40°C, If = 20mA	1,000 h	0/20
Wet High Temp. Operating Life	EIAJ ED-4701/100(102)	Ta = 60°C, 90%, If = 20mA	1,000 h	0/20
Wet High Temp. Storage Life	EIAJ ED-4701/100(103)	Ta = 60°C, 90%	1,000 h	0/20
Thermal Shock	EIAJ ED-4701/100(105)	Ta = -40°C ~ 110°C (each 15min.)	1,000 cycles	0/20
Thermal Shock Operating	EIAJ ED-4701/100(105)	Ta = -40°C(OFF) ~ 85°C(If = 10mA ON) (each 15min.)	1,000 cycles	0/20
High Temp. Storage Life	EIAJ ED-4701/200(201)	Ta = 110°C	1,000 h	0/20
Low Temp. Storage Life	EIAJ ED-4701/200(202)	Ta = -40°C	1,000 h	0/20
Cycled Temp. Humidity Operating Life	EIAJ ED-4701/200(203)	Ta = -30°C ~ 80°C, 95%, 8h/cycle	30 cycles	0/20
Resistance to Reflow Soldering	EIAJ ED-4701/300(301)	Moisture Soak : 30°C, 70%, 168h Preheat : 150°C~180°C (120s Max.) Soldering Temp. : 260°C (5s)	Twice	0/20
Electric Static Discharge (ESD) ^{※1}	EIAJ ED-4701/300(304)	C = 100pF, R2 = 1.5KΩ, ±2,000V	once each polarity	0/20
Vibration, Variable Frequency	EIAJ ED-4701/400(403)	98.1m/s ² (10G), 100 ~ 2KHz, 20min. XYZ各方向	2 h	0/20

※1 Reference test

Failure Criteria

Items	Symbols	Conditions	Failure criteria
Luminous Intensity	Iv	If=10mA	Testing Min. Value < Spec. Min. Value x 0.5
Forward Voltage	V _F	If=10mA	Testing Max. Value ≥ Spec. Max. Value x 1.2
Reverse Current	I _R	V _R =5V	Testing Max. Value ≥ Spec. Max. Value x 2.5
Cosmetic Appearance	-	-	Occurrence of notable decoloration, deformation and cracking

Special Notice to Customers Using the Products and Technical Information Shown in This Data Sheet

- 1) The technical information shown in the data sheets are limited to the typical characteristics and circuit examples of the referenced products. It does not constitute the warranting of industrial property nor the granting of any license.
- 2) For the purpose of product improvement, the specifications, characteristics and technical data described in the data sheets are subject to change without prior notice. Therefore it is recommended that the most updated specifications be used in your design.
- 3) When using the products described in the data sheets, please adhere to the maximum ratings for operating voltage, heat dissipation characteristics, and other precautions for use. We are not responsible for any damage which may occur if these specifications are exceeded.
- 4) The products that have been described to this catalog are manufactured so that they will be used for the electrical instrument of the benchmark (OA equipment, telecommunications equipment, AV machine, home appliance and measuring instrument).
The application of aircrafts, space borne application, transportation equipment, medical equipment and nuclear power control equipment, etc. needs a high reliability and safety, and the breakdown and the wrong operation might influence the life or the human body. Please consult us beforehand if you plan to use our product for the usages of aircrafts, space borne application, transportation equipment, medical equipment and nuclear power control equipment, etc. except OA equipment, telecommunications equipment, AV machine, home appliance and measuring instrument.
- 5) In order to export the products or technologies described in this data sheet which are under the "Foreign Exchange and Foreign Trade Control Law," it is necessary to first obtain an export permit from the Japanese government.
- 6) No part of this data sheet may be reprinted or reproduced without prior written permission from Stanley Electric Co., Ltd.
- 7) The most updated edition of this data sheet can be obtained from the address below:
<http://www.stanley-components.com>