

FEATURES

- Delivers 3.3V at 900mA From 2 Alkaline/NiMH Cells
- Delivers 5V at 900mA From a Lithium-Polymer Battery
- V_{IN} Start-Up Voltage: 700mV
- 1.5V to 5.25V V_{OUT} Range
- Up to 94% Efficiency
- $V_{IN} > V_{OUT}$ Operation
- 1MHz (LTC3539) or 2MHz (LTC3539-2) Fixed Frequency Operation
- Output Disconnect
- Selectable Burst Mode® or PWM Operation
- 10 μ A Quiescent Current
- Logic Controlled Shutdown: <1 μ A
- Requires Only 6 External Components
- Low Profile (2mm \times 3mm \times 0.75mm) DFN Package

APPLICATIONS

- Medical Instruments
- Portable Bar Code Scanners
- Noise Canceling Headphones
- Portable GPS Navigation
- Handheld PCs

DESCRIPTION

The LTC®3539/LTC3539-2 are synchronous, 2A step-up DC/DC converters with output disconnect. Synchronous rectification enables high efficiency in the low profile 2mm \times 3mm DFN package. Battery life is extended with a 700mV start-up voltage and operation down to 500mV once started.

A switching frequency of 1MHz (LTC3539) or 2MHz (LTC3539-2) minimizes solution footprint by allowing the use of tiny, low profile inductors and ceramic capacitors. The current mode PWM design is internally compensated, reducing external parts count. The LTC3539/LTC3539-2 feature a pin-enabled automatic Burst Mode operation at light load conditions. Anti-ring circuitry reduces EMI by damping the inductor in discontinuous mode. Additional features include a low shutdown current of under 1 μ A and thermal overload protection.

The LTC3539/LTC3539-2 are offered in a 2mm \times 3mm \times 0.75mm DFN package.

LT, LT, LTC, LTM and Burst Mode are registered trademarks of Linear Technology Corporation. All other trademarks are the property of their respective owners.

TYPICAL APPLICATION

Wide V_{IN} , High Power 3.3V Regulator

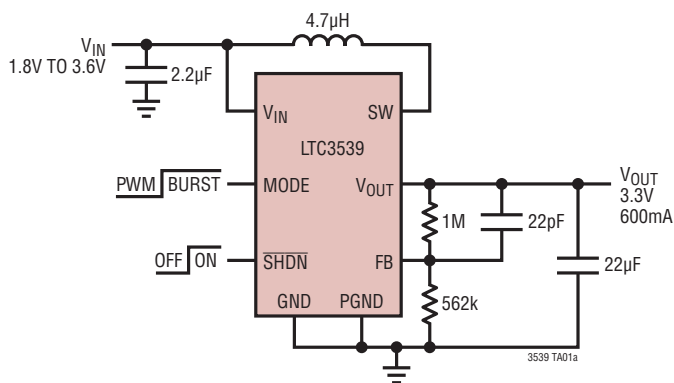

Efficiency and Power Loss vs Load Current

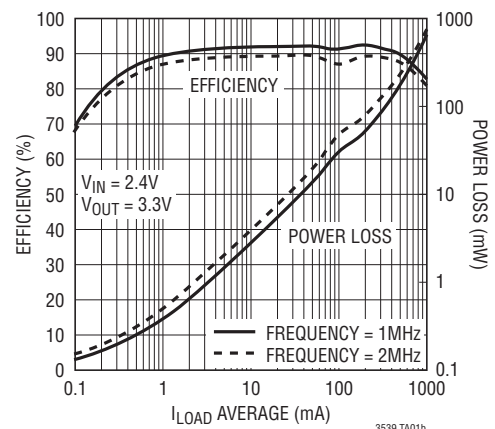

LTC3539/LTC3539-2

ABSOLUTE MAXIMUM RATINGS

(Note 1)

V_{IN} Voltage.....	-0.3V to 6V
SW Voltage	
DC.....	-0.3V to 6V
Pulsed <100ns.....	-0.3V to 7V
SHDN, FB, MODE Voltage.....	-0.3V to 6V
V_{OUT}	-0.3V to 6V
Operating Temperature (Notes 2, 5).....	-40°C to 85°C
Storage Temperature Range.....	-65°C to 125°C

PIN CONFIGURATION

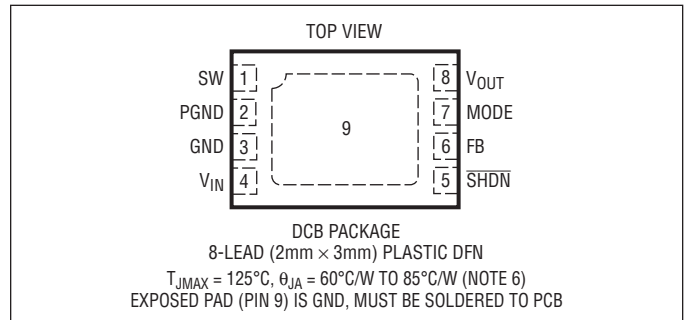

ORDER INFORMATION

LEAD FREE FINISH	TAPE AND REEL	PART MARKING	PACKAGE DESCRIPTION	TEMPERATURE RANGE
LTC3539EDCB#PBF	LTC3539EDCB#TRPBF	LDCS	8-Lead (2mm × 3mm) Plastic DFN	-40°C to 85°C
LTC3539EDCB-2#PBF	LTC3539EDCB-2#TRPBF	LDPH	8-Lead (2mm × 3mm) Plastic DFN	-40°C to 85°C

Consult LTC Marketing for parts specified with wider operating temperature ranges.

Consult LTC Marketing for information on non-standard lead based finish parts.

For more information on lead free part marking, go to: <http://www.linear.com/leadfree/>

For more information on tape and reel specifications, go to: <http://www.linear.com/tapeandreel/>

ELECTRICAL CHARACTERISTICS

The ● denotes the specifications which apply over the specified temperature range of -40°C to 85°C, otherwise specifications are at $T_A = 25^\circ\text{C}$. $V_{IN} = 1.2\text{V}$, $V_{OUT} = 3.3\text{V}$, unless otherwise noted.

PARAMETER	CONDITIONS	MIN	TYP	MAX	UNITS
Input Voltage Range	After Start-Up	0.5		5	V
Minimum Start-Up Voltage	$I_{LOAD} = 1\text{mA}$, $V_{OUT} = 0\text{V}$		0.7	0.88	V
Output Voltage Adjust Range		● 1.5		5.25	V
Feedback Voltage		● 1.170	1.200	1.230	V
Feedback Input Current	$V_{FB} = 1.2\text{V}$		1	50	nA
Quiescent Current - Shutdown	$V_{SHDN} = 0\text{V}$, Not Including Switch Leakage, $V_{OUT} = 0\text{V}$		0.01	1	μA
Quiescent Current - Active	Measured on V_{OUT} , Non-Switching		300	500	μA
Quiescent Current - Burst	Measured on V_{OUT} , $FB > 1.230\text{V}$		10	18	μA
N-Channel MOSFET Switch Leakage Current	$V_{SW} = 5\text{V}$		0.1	10	μA
P-Channel MOSFET Switch Leakage Current	$V_{SW} = 5\text{V}$, $V_{OUT} = 0\text{V}$		0.1	20	μA
N-Channel MOSFET Switch On Resistance	$V_{OUT} = 3.3\text{V}$		0.09		Ω
P-Channel MOSFET Switch On Resistance	$V_{OUT} = 3.3\text{V}$		0.125		Ω
N-Channel MOSFET Current Limit		● 2	2.6		A

3539f

ELECTRICAL CHARACTERISTICS

The ● denotes the specifications which apply over the specified temperature range of -40°C to 85°C , otherwise specifications are at $T_A = 25^{\circ}\text{C}$. $V_{\text{IN}} = 1.2\text{V}$, $V_{\text{OUT}} = 3.3\text{V}$, unless otherwise noted.

PARAMETER	CONDITIONS		MIN	TYP	MAX	UNITS
Maximum Duty Cycle	$V_{\text{FB}} = 1.15\text{V}$	●	87	90		%
Minimum Duty Cycle	$V_{\text{FB}} = 1.3\text{V}$	●			0	%
Switching Frequency	LTC3539	●	0.7	1	1.3	MHz
	LTC3539-2	●	1.8	2	2.4	MHz
MODE Input High Voltage			0.88			V
MODE Input Low Voltage					0.3	V
MODE Input Current	$V_{\text{MODE}} = 1.2\text{V}$			0.3	1	μA
$\overline{\text{SHDN}}$ Input High Voltage			0.88			V
$\overline{\text{SHDN}}$ Input Low Voltage					0.3	V
$\overline{\text{SHDN}}$ Input Current	$V_{\text{SHDN}} = 1.2\text{V}$			0.3	1	μA
	$V_{\text{SHDN}} = 3.3\text{V}$			1	2	μA

Note 1: Stresses beyond those listed under Absolute Maximum Ratings may cause permanent damage to the device. Exposure to any Absolute Maximum Rating condition for extended periods may affect device reliability and lifetime.

Note 2: The LTC3539E/LTC3539E-2 is guaranteed to meet performance specifications from 0°C to 85°C . Specifications over -40°C to 85°C operating temperature range are assured by design, characterization and correlation with statistical process controls.

Note 3: Specification is guaranteed by design and not 100% tested in production.

Note 4: Current measurements are made when the output is not switching.

Note 5: This IC includes overtemperature protection that is intended to protect the device during momentary overload conditions. Junction temperature will exceed 125°C when overtemperature protection is active. Continuous operation above the specified maximum operating junction temperature may result in device degradation or failure.

Note 6: Failure to solder the exposed backside of the package to the PC board ground plane will result in a thermal resistance much higher than $60^{\circ}\text{C}/\text{W}$.

TYPICAL PERFORMANCE CHARACTERISTICS ($T_A = 25^\circ\text{C}$ unless otherwise noted)

Efficiency vs Load Current and V_{IN} , $V_{OUT} = 1.8\text{V}$

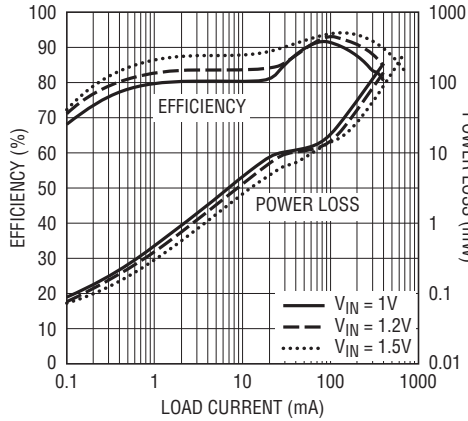

3539 G01

Efficiency vs Load Current and V_{IN} , $V_{OUT} = 3.3\text{V}$

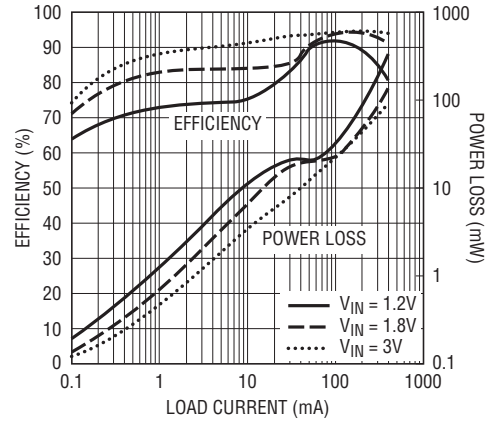

3539 G02

Efficiency vs Load Current and V_{IN} , $V_{OUT} = 5\text{V}$

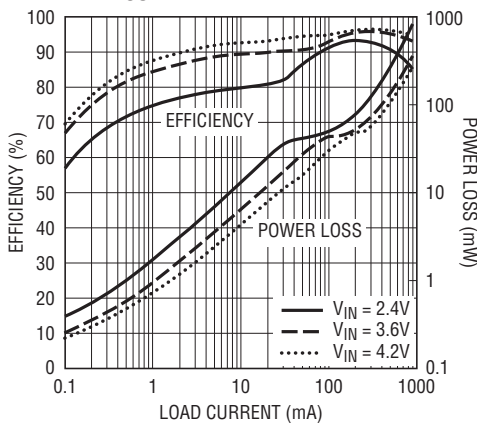

3539 G03

No Load Input Current vs V_{IN}

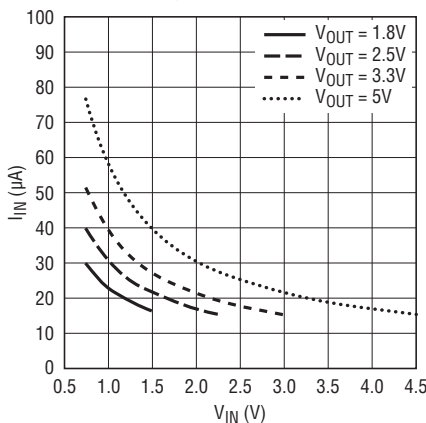

3539 G04

Maximum Output Current vs V_{IN}

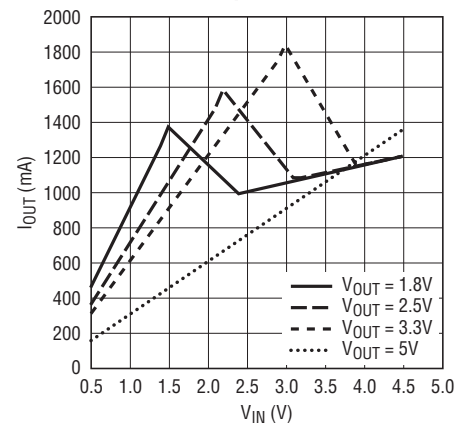

3539 G05

Minimum Load Resistance During Start-Up vs V_{IN}

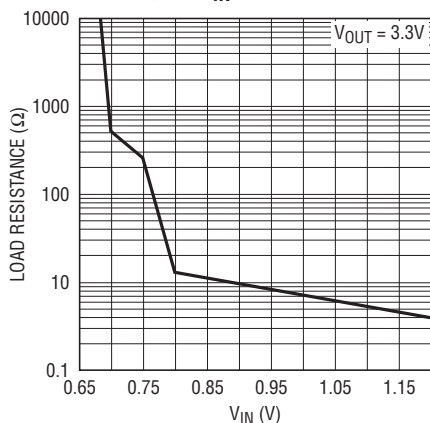

3539 G06

Burst Mode Threshold Current vs V_{IN} and V_{OUT}

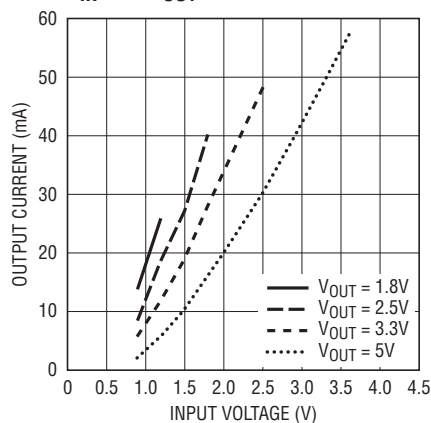

3539 G11

Normalized Current Limit vs V_{OUT}

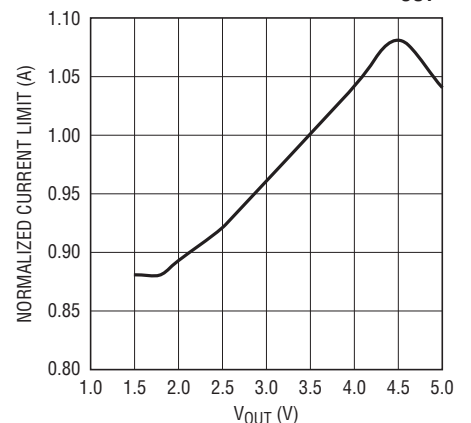

3539 G16

TYPICAL PERFORMANCE CHARACTERISTICS

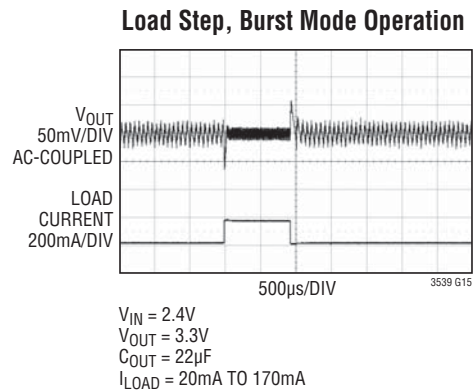
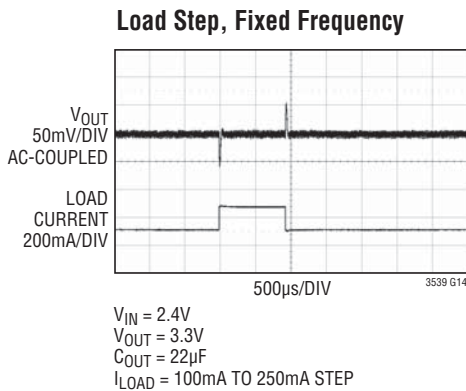
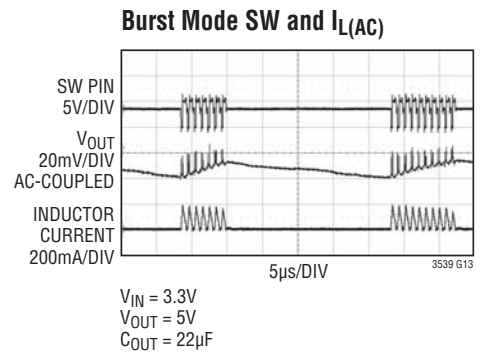
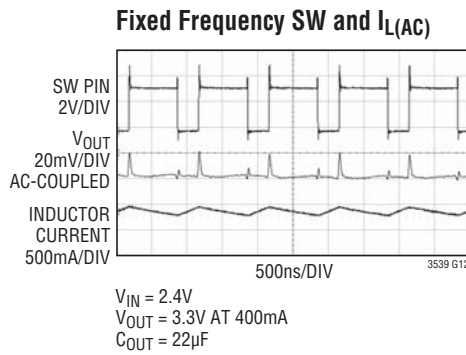
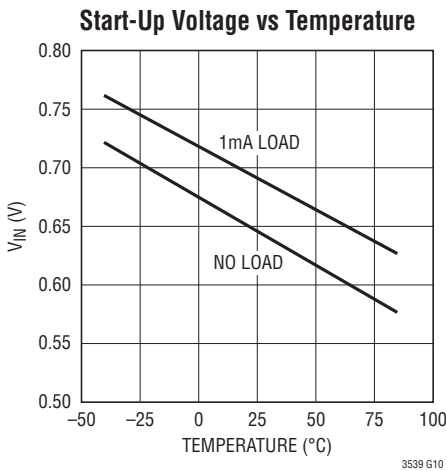
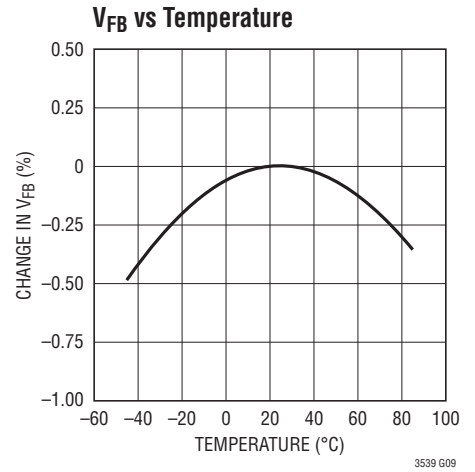
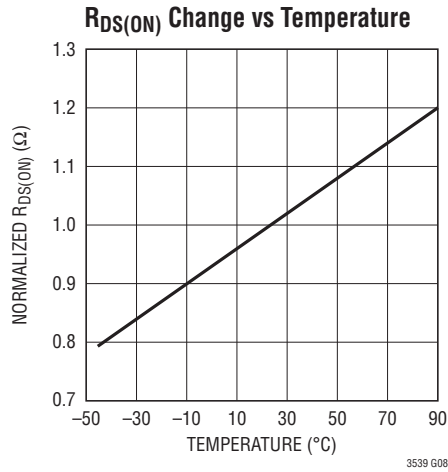
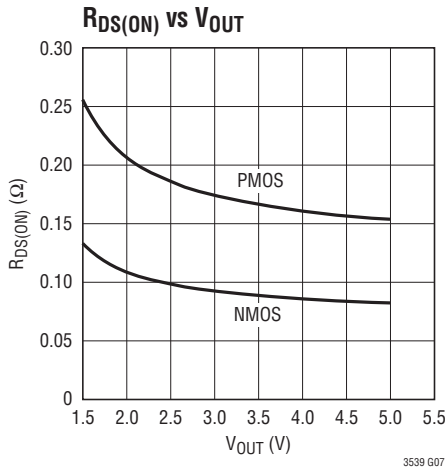

PIN FUNCTIONS

SW (Pin 1): Switch Pin. Connect inductor between SW and V_{IN} . Keep PCB trace lengths as short and wide as possible to reduce EMI. If the inductor current falls to zero, or SHDN is low, an internal anti-ringing resistor is connected from SW to V_{IN} to minimize EMI.

PGND (Pin 2), GND (Pin 3): Signal and Power Ground. Provide a short direct PCB path between PGND, GND and the (-) side of the input and output capacitors.

V_{IN} (Pin 4): Battery Input Voltage. Connect a minimum of 2.2 μ F ceramic decoupling capacitor from this pin to ground.

SHDN (Pin 5): Logic Controlled Shutdown Input. There is an internal 4M Ω pull-down on this pin.

SHDN = High: Normal operation.

SHDN = Low: Shutdown, quiescent current <1 μ A.

FB (Pin 6): Feedback Input to the g_m Error Amplifier. Connect resistor divider tap to this pin. The output voltage can be adjusted from 1.5V to 5.25V by: $V_{OUT} = 1.20V \cdot [1 + (R2/R1)]$

MODE (Pin 7): Burst Mode Pin. A logic controlled input to select either automatic Burst Mode operation or forced fixed frequency operation.

MODE = High: Burst Mode operation at light loads

MODE = Low: Fixed frequency PWM Mode

V_{OUT} (Pin 8): Output Voltage Sense and Drain of the Internal Synchronous Rectifier. PCB trace length from V_{OUT} to the output filter capacitor should be as short and wide as possible.

Exposed Pad (Pin 9): The exposed pad must be soldered to the PCB ground plane. It serves as another ground connection, and as a means of conducting heat away from the die.

BLOCK DIAGRAM

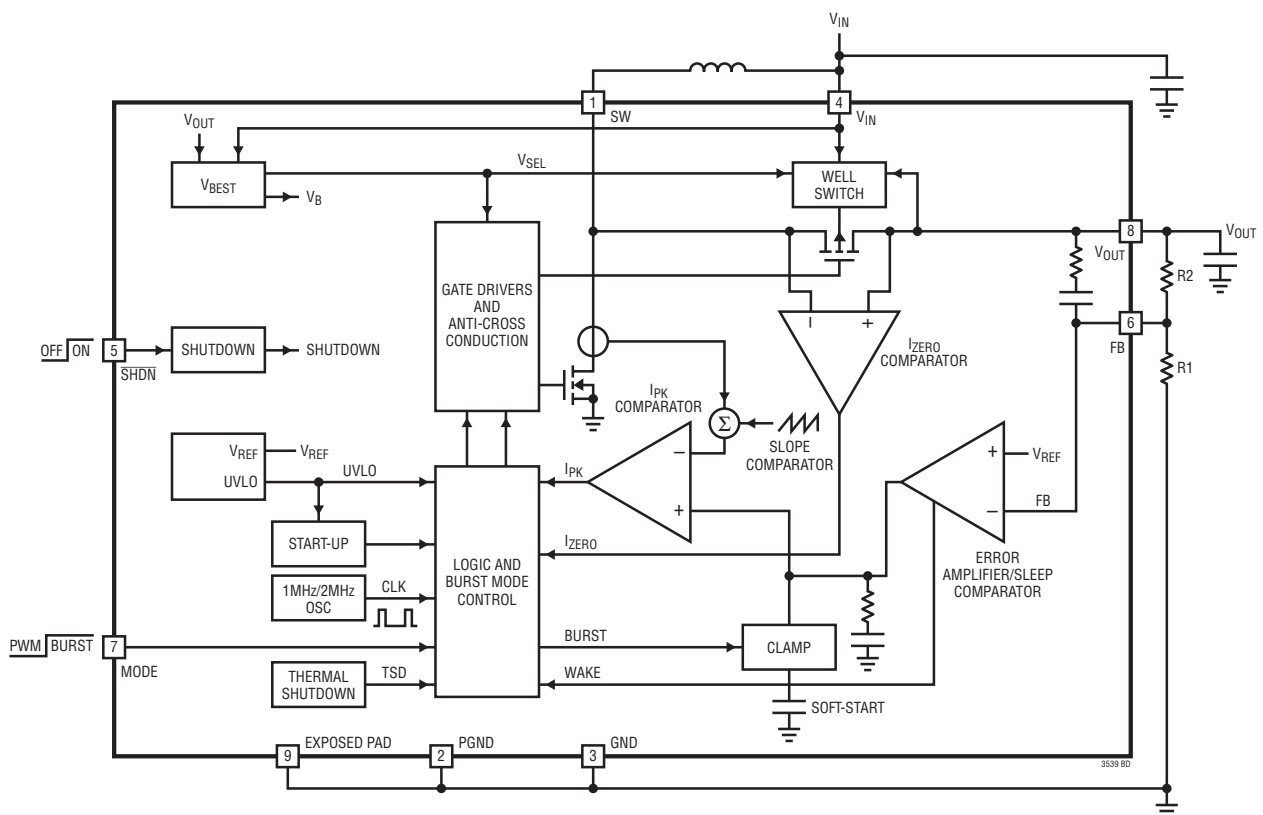

OPERATION

DETAILED DESCRIPTION

The LTC3539 is a high power synchronous boost converter in an 8-lead 2mm × 3mm DFN package. With the ability to start up and operate from inputs of 700mV, the device features fixed frequency, current mode PWM control for exceptional line and load regulation. The current mode architecture with adaptive slope compensation provides excellent transient load response, requiring minimal output filtering. Internal soft-start and internal loop compensation simplifies the design process while minimizing the number of external components. The switching frequency of the LTC3539 is nominally 1MHz, while the LTC3539-2 switches at 2MHz. Operation of the LTC3539 and LTC3539-2 is identical in all other respects.

With its low $R_{DS(ON)}$ and low gate charge internal N-channel MOSFET switch and P-channel MOSFET synchronous rectifier, the LTC3539 achieves high efficiency over a wide range of load current. Burst Mode operation maintains high efficiency at very light loads, reducing the quiescent current to just 10 μ A.

Converter operation can be best understood by referring to the Block Diagram.

Low Voltage Start-Up

The LTC3539 includes an independent start-up oscillator designed to start up at an input voltage of 0.7V (typical). Soft-start and inrush current limiting are provided during start-up, as well as normal mode.

When either V_{IN} or V_{OUT} exceeds 1.4V typical, the IC enters normal operating mode. Once the output voltage exceeds the input by 0.24V, the IC powers itself from V_{OUT} instead of V_{IN} . At this point the internal circuitry has no dependency on the V_{IN} input voltage, eliminating the requirement for a large input capacitor. The input voltage can drop as low as 0.5V. The limiting factor for the application becomes the ability of the power source to supply sufficient energy to the output at the low voltages, and the maximum duty cycle, which is clamped at 90% typical. Note that at low input voltages, small voltage drops due

to series resistance become critical, and greatly limit the power delivery capability of the converter.

Low Noise Fixed Frequency Operation

Soft-Start: The LTC3539/LTC3539-2 contains internal circuitry to provide soft-start operation. The internal soft-start circuitry ramps the peak inductor current from zero to its peak value of 2.6A (typical) in approximately 0.5ms, allowing start-up into heavy loads. The soft-start circuitry is reset in the event of a thermal shutdown or shutdown command.

Oscillator: An internal oscillator sets the switching frequency to 1MHz for the LTC3539, and 2MHz for the LTC3539-2.

Shutdown: The part is shutdown by pulling the \overline{SHDN} pin below 0.3V, and activated by pulling the \overline{SHDN} pin above 0.88V. Note that \overline{SHDN} can be driven above V_{IN} or V_{OUT} , as long as it is limited to less than the absolute maximum rating.

Error Amplifier: The error amplifier is a transconductance type. The non-inverting input is internally connected to the 1.2V reference and the inverting input is connected to FB. Clamps limit the minimum and maximum error amp output voltage for improved large signal transient response. Power converter control loop compensation is provided internally. A voltage divider from V_{OUT} to ground programs the output voltage via FB from 1.5V to 5.25V. $V_{OUT} = 1.2V \cdot [1 + (R2/R1)]$.

Current Sensing: Lossless current sensing converts the peak current signal of the N-channel MOSFET switch into a voltage which is summed with the internal slope compensation. The summed signal is compared to the error amplifier output to provide a peak current control command for the PWM.

Current Limit: The current limit comparator shuts off the N-channel MOSFET switch once its threshold is reached. Peak switch current is limited to approximately 2.6A, independent of input or output voltage, unless V_{OUT} falls below 0.7V, in which case the current limit is cut in half.

OPERATION

Zero Current Comparator: The zero current comparator monitors the inductor current to the output and shuts off the synchronous rectifier once this current reduces to approximately 40mA. This prevents the inductor current from reversing in polarity, improving efficiency at light loads.

Synchronous Rectifier: The P-channel MOSFET synchronous rectifier is disabled when V_{OUT} is much less than V_{IN} . This is to control inrush current and to prevent inductor current from running away

Anti-ringing Control: The anti-ringing control connects a resistor across the inductor to prevent high frequency ringing on the SW pin during discontinuous current mode operation. The ringing of the resonant circuit formed by L and C_{SW} (capacitance on SW pin) is low energy, but can cause EMI radiation.

Output Disconnect: The LTC3539 is designed to allow true output disconnect by eliminating body diode conduction of the internal P-channel MOSFET rectifier. This allows V_{OUT} to go to zero volts during shutdown, drawing no current from the input source. It also provides inrush current limiting at turn-on, minimizing surge currents seen by the input supply. Note that to obtain the advantages of output disconnect, there must not be an external Schottky diode connected between the SW pin and V_{OUT} . The output disconnect feature also allows V_{OUT} to be pulled high, without any reverse current into a battery on V_{IN} .

Thermal Shutdown: If the die temperature exceeds 160°C, the device will go into thermal shutdown. All switches will be turned off and the internal soft-start capacitor will be discharged. The device will be enabled again when the die temperature drops by about 15°C.

Burst Mode Operation

When Burst Mode operation is enabled by bringing the MODE pin above 0.88V, the LTC3539 will automatically

enter Burst Mode operation at light load current, then return to fixed frequency PWM mode when the load increases. Refer to the typical performance characteristics to see the output load Burst Mode threshold vs V_{IN} . The load current at which Burst Mode operation is entered can be changed by adjusting the inductor value. Raising the inductor value will lower the load current at which Burst Mode operation is entered.

In Burst Mode operation, the LTC3539 still switches at a fixed frequency, using the same error amplifier and loop compensation for peak current mode control. This control method eliminates any output transient when switching between modes. In Burst Mode operation, energy is delivered to the output until it reaches the nominal regulation value, then the LTC3539 transitions to Sleep mode where the outputs are off and the LTC3539 consumes only 10 μ A of quiescent current from V_{OUT} . When the output voltage droops slightly, switching resumes. This maximizes efficiency at very light loads by minimizing switching and quiescent current losses. Burst Mode output voltage ripple, which is typically 1% peak to peak, can be reduced by using more output capacitance (47 μ F or greater).

As the load increases, the LTC3539 will automatically leave Burst Mode operation. Once the LTC3539 has left Burst Mode operation and returned to normal operation, it will remain there until the output load is reduced below the burst threshold.

Burst Mode operation is inhibited during start-up until soft-start is complete and V_{OUT} is at least 0.24V greater than V_{IN} .

When the MODE pin is below 0.3V, the LTC3539 features continuous PWM operation. In this mode, at very light loads, the LTC3539 will exhibit pulse-skip operation. If the MODE pin voltage exceeds the greater of V_{IN} or V_{OUT} by 0.5V, the MODE pin will sink additional current.

APPLICATIONS INFORMATION

$V_{IN} > V_{OUT}$ Operation

The LTC3539 will maintain output voltage regulation even when the input voltage is above the desired output. Note that the efficiency and the maximum output current capability are reduced. Refer to Typical Performance Characteristics.

Short-Circuit Protection

The LTC3539 output disconnect feature allows an output short circuit while maintaining a maximum internally set current limit. To reduce power dissipation under short-circuit conditions, the peak switch current limit is reduced to 1.4A (typical).

Schottky Diode

Although it is not required, adding a Schottky diode from SW to V_{OUT} will improve efficiency by about 2%. Note that this defeats the output disconnect, $V_{IN} > V_{OUT}$ operation and short circuit protection features.

PCB LAYOUT GUIDELINES

The high speed operation of the LTC3539 demands careful attention to board layout. A careless layout will result in reduced performance. Figure 1 shows the recommended component placement. A large ground pin copper area will help to lower the die temperature. A multilayer board with a separate ground plane is ideal.

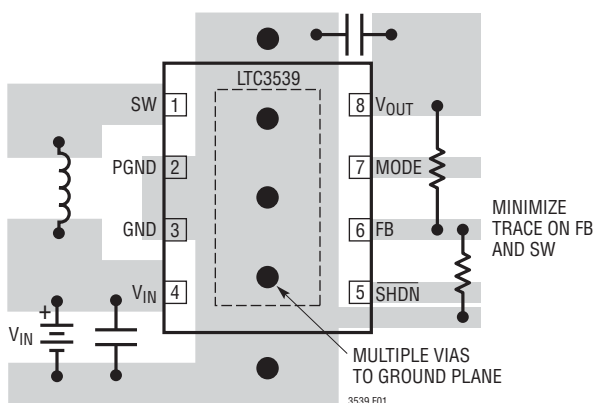

Figure 1. Recommended Component Placement for Single Layer Board

COMPONENT SELECTION

Inductor Selection

The LTC3539 can utilize small surface mount and chip inductors due to the high switching frequency. Inductor values between $3.3\mu\text{H}$ and $4.7\mu\text{H}$ for the LTC3539 and between $1.5\mu\text{H}$ and $2.5\mu\text{H}$ for the LTC3539-2 are suitable for most applications*. Larger values of inductance will allow slightly greater output current capability (and lower the Burst Mode threshold) by reducing the inductor ripple current. However, increasing the inductance above $10\mu\text{H}$ will increase size while providing little improvement in output current capability.

The minimum inductance value is given by:

$$L > \frac{V_{IN(MIN)} \cdot (V_{OUT(MAX)} - V_{IN(MIN)})}{\text{Ripple} \cdot V_{OUT(MAX)} \cdot f}$$

Where:

$f = 1$ for the LTC3539 or 2.2 for the LTC3539-2

Ripple = allowable inductor current ripple (Amps peak-to-peak)

$V_{IN(MIN)}$ = minimum input voltage

$V_{OUT(MAX)}$ = maximum output voltage

The inductor current ripple is typically set for 20% to 40% of the maximum inductor current. High frequency ferrite core inductor materials improve efficiency by reducing frequency dependent power losses compared to cheaper powdered iron types. The inductor should have low ESR (series resistance of the windings) to reduce the I^2R power losses, and must accommodate the peak inductor current without saturating. Molded chokes and some chip inductors usually do not have enough core area to support the peak inductor current of 2.6A seen on the LTC3539. To minimize radiated noise, use a shielded inductor. See Table 1 for suggested suppliers and representative components.

*Single cell applications ($V_{IN} < 1.6\text{V}$) should use a $2.2\mu\text{H}$ inductor for the LTC3539

APPLICATIONS INFORMATION

Table 1. Representative Inductors

VENDOR	PART/STYLE
Coilcraft (847) 639-6400 www.coilcraft.com	MSS5131 LPS4018-222 MSS6132 MOS6020
Murata www.murata.com	LQH55D LQH66S
Sumida (847) 956-0666 www.sumida.com	CDRH4D22 CDRH4D28C CDRH5D28 CDR6D23
TDK (847) 803-6100 www.component.tdk.com	VL5014ST
Toko (408) 432-8282 www.tokoam.com	D53LC D63LCB
Würth (201) 785-8800 www.we-online.com	WE-TPC Type LH, X WE-PD Type XS

Output and Input Capacitor Selection

The internal loop compensation of the LTC3539 is designed to be stable with output capacitor values of 10 μ F or greater. Although ceramic capacitors are recommended, low ESR (equivalent series resistance) tantalum capacitors may be used as well.

Low ESR capacitors should be used to minimize the output voltage ripple. Multilayer ceramic capacitors are an excellent choice as they have extremely low ESR and are available in small footprints. A 22 μ F to 47 μ F output capacitor is sufficient for output voltages of 3V or greater.

An output capacitor of up to 100 μ F is required at lower output voltages. Even with V_{OUT} greater than 3V, larger values up to 100 μ F may be used to obtain extremely low output voltage ripple and improve transient response. X5R and X7R dielectric materials are preferred for their ability to maintain capacitance over wide voltage and temperature ranges. Y5V types should not be used.

A small ceramic capacitor in parallel with a larger tantalum capacitor may be used in demanding applications which have large load transients. A feedforward capacitor across the top resistor of the feedback divider (from V_{OUT} to FB) is usually required to improve transient response. A typical value of 22pF will generally suffice.

Low ESR input capacitors reduce input switching noise and reduce the peak current drawn from the battery. It follows that ceramic capacitors are also a good choice for input decoupling and should be located as close as possible to the device. A 2.2 μ F input capacitor is sufficient for most applications. Larger values may be used without limitations. Table 2 shows a list of several ceramic capacitor manufacturers. Consult the manufacturers directly for detailed information on their selection of ceramic parts.

Table 2. Capacitor Vendor Information

SUPPLIER	PHONE	WEBSITE
AVX	(803) 448-9411	www.avxcorp.com
Murata	(714) 852-2001	www.murata.com
Taiyo-Yuden	(408) 573-4150	www.t-yuden.com
TDK	(847) 803-6100	www.component.tdk.com

TYPICAL APPLICATIONS

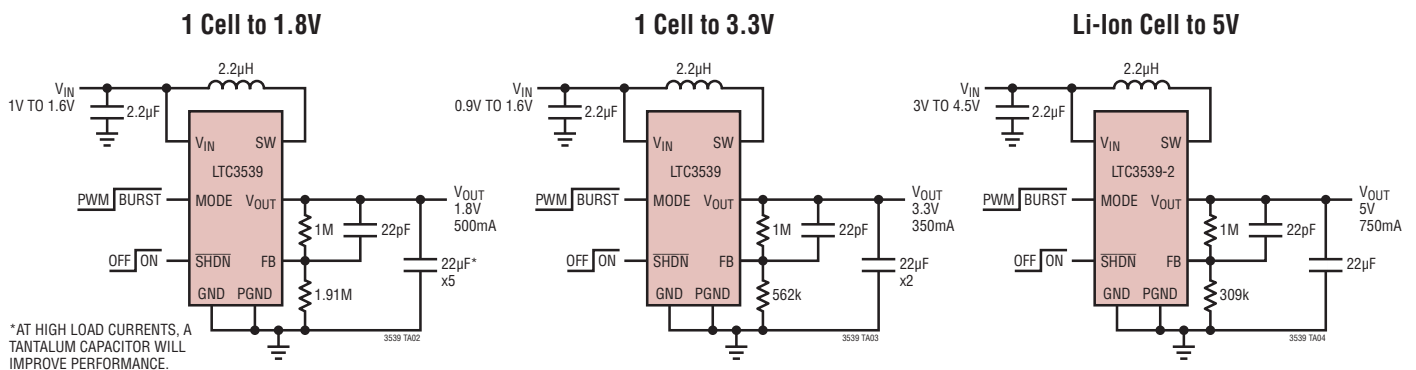

PACKAGE DESCRIPTION

DCB Package
8-Lead Plastic DFN (2mm × 3mm)
 (Reference LTC DWG # 05-08-1718 Rev A)

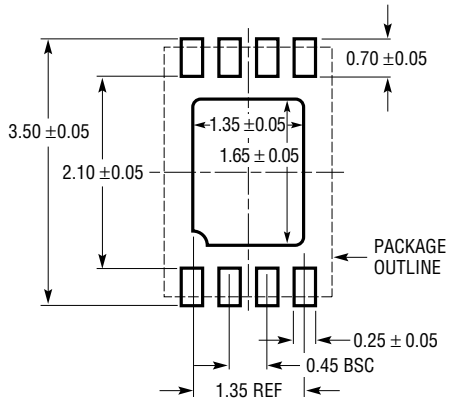

RECOMMENDED SOLDER PAD PITCH AND DIMENSIONS
 APPLY SOLDER MASK TO AREAS THAT ARE NOT SOLDERED

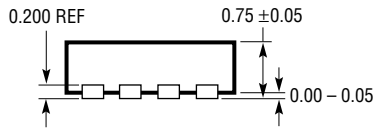
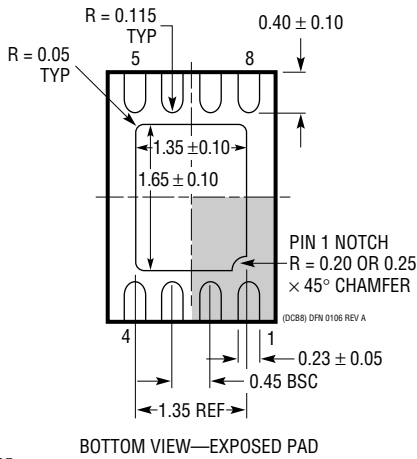
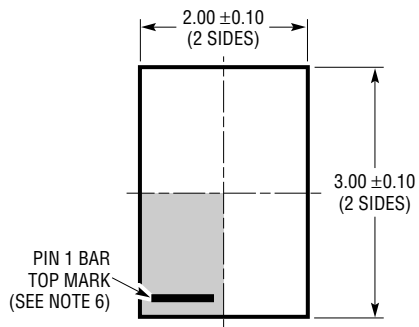

- NOTE:
1. DRAWING IS NOT A JEDEC PACKAGE OUTLINE
 2. DRAWING NOT TO SCALE
 3. ALL DIMENSIONS ARE IN MILLIMETERS
 4. DIMENSIONS OF EXPOSED PAD ON BOTTOM OF PACKAGE DO NOT INCLUDE MOLD FLASH. MOLD FLASH, IF PRESENT, SHALL NOT EXCEED 0.15mm ON ANY SIDE
 5. EXPOSED PAD SHALL BE SOLDER PLATED
 6. SHADED AREA IS ONLY A REFERENCE FOR PIN 1 LOCATION ON THE TOP AND BOTTOM OF PACKAGE

LTC3539/LTC3539-2

RELATED PARTS

PART NUMBER	DESCRIPTION	COMMENTS
LTC3400/ LTC3400B	600mA I_{SW} , 1.2MHz, Synchronous Step-Up DC/DC Converters	92% Efficiency V_{IN} : 0.85V to 5V, $V_{OUT(MAX)}$ = 5V, I_Q = 19 μ A/300 μ A, I_{SD} <1 μ A, ThinSOT™ Package
LTC3401	1A I_{SW} , 3MHz, Synchronous Step-Up DC/DC Converter	97% Efficiency V_{IN} : 0.5V to 5V, $V_{OUT(MAX)}$ = 6V, I_Q = 38 μ A, I_{SD} <1 μ A, 10-Lead MS Package
LTC3402	2A I_{SW} , 3MHz, Synchronous Step-Up DC/DC Converter	97% Efficiency V_{IN} : 0.5V to 5V, $V_{OUT(MAX)}$ = 6V, I_Q = 38 μ A, I_{SD} <1 μ A, 10-Lead MS Package
LTC3421	3A I_{SW} , 3MHz, Synchronous Step-Up DC/DC Converter with Output Disconnect	95% Efficiency V_{IN} : 0.5V to 4.5V, $V_{OUT(MAX)}$ = 5.25V, I_Q = 12 μ A, I_{SD} <1 μ A, QFN24 Package
LTC3422	1.5A I_{SW} , 3MHz Synchronous Step-Up DC/DC Converter with Output Disconnect	95% Efficiency V_{IN} : 0.5V to 4.5V, $V_{OUT(MAX)}$ = 5.25V, I_Q = 25 μ A, I_{SD} <1 μ A, 3mm \times 3mm DFN Package
LTC3423/ LTC3424	1A/2A I_{SW} , 3MHz, Synchronous Step-Up DC/DC Converter	95% Efficiency V_{IN} : 0.5V to 5.5V, $V_{OUT(MAX)}$ = 5.5V, I_Q = 38 μ A, I_{SD} <1 μ A, 10-Lead MS Package
LTC3426	2A I_{SW} , 1.2MHz, Step-Up DC/DC Converter	92% Efficiency V_{IN} : 1.6V to 4.3V, $V_{OUT(MAX)}$ = 5V, I_{SD} <1 μ A, SOT-23 Package
LTC3428	500mA I_{SW} , 1.25MHz/2.5MHz, Synchronous Step-Up DC/DC Converters with Output Disconnect	92% Efficiency V_{IN} : 1.8V to 5V, $V_{OUT(MAX)}$ = 5.25V, I_{SD} <1 μ A, 3mm \times 3mm DFN Package
LTC3429	600mA I_{SW} , 500kHz, Synchronous Step-Up DC/DC Converter with Output Disconnect and Soft-Start	96% Efficiency V_{IN} : 0.5V to 4.4V, $V_{OUT(MAX)}$ = 5V, I_Q = 20 μ A/300 μ A,
LTC3458	1.4A I_{SW} , 1.5MHz, Synchronous Step-Up DC/DC Converter/Output Disconnect/Burst Mode Operation	93% Efficiency V_{IN} : 1.5V to 6V, $V_{OUT(MAX)}$ = 7.5V, I_Q = 15 μ A, I_{SD} <1 μ A, DFN12 Package
LTC3458L	1.7A I_{SW} , 1.5MHz, Synchronous Step-Up DC/DC Converter with Output Disconnect, Automatic Burst Mode Operation	94% Efficiency $V_{OUT(MAX)}$ = 6V, I_Q = 12 μ A, DFN12 Package
LTC3459	70mA I_{SW} , 10V Micropower Synchronous Boost Converter/Output Disconnect/Burst Mode Operation	V_{IN} : 1.5V to 5.5V, $V_{OUT(MAX)}$ = 10V, I_Q = 10 μ A, I_{SD} <1 μ A, ThinSOT Package
LTC3525-3/ LTC3525-3.3/ LTC3525-5	400mA Micropower Synchronous Step-Up DC/DC Converter with Output Disconnect	95% Efficiency V_{IN} : 1V to 4.5V, $V_{OUT(MAX)}$ = 3.3V or 5V, I_Q = 7 μ A, I_{SD} <1 μ A, SC-70 Package
LTC3525L-3	400mA Micropower Synchronous Step-Up DC/DC Converter with Output Disconnect	95% Efficiency V_{IN} : 0.88V to 4.5V, $V_{OUT(MAX)}$ = 3V, I_Q = 7 μ A, I_{SD} <1 μ A, SC-70 Package
LTC3526/ LTC3526B	500mA, 1MHz Synchronous Step-Up DC/DC Converter with Output Disconnect	94% Efficiency V_{IN} : 0.85V to 5V, $V_{OUT(MAX)}$ = 5.25V, I_Q = 9 μ A, I_{SD} <1 μ A, 2mm \times 2mm DFN-6 Package
LTC3526L	550mA, 1MHz Synchronous Step-Up DC/DC Converter with Output Disconnect	94% Efficiency V_{IN} : 0.68V to 5V, $V_{OUT(MAX)}$ = 5.25V, I_Q = 9 μ A, I_{SD} <1 μ A, 2mm \times 2mm DFN-6 Package
LTC3527/ LTC3527-1	Dual 800mA/400mA, 1.2MHz/2.2MHz Synchronous Step-Up DC/DC Converter with Output Disconnect	94% Efficiency V_{IN} : 0.68V to 5V, $V_{OUT(MAX)}$ = 5.25V, I_Q = 12 μ A, I_{SD} <1 μ A, 3mm \times 3mm QFN-16 Package
LTC3528/ LTC3528B	1A, 1MHz Synchronous Step-Up DC/DC Converter with Output Disconnect	94% Efficiency V_{IN} : 0.68V to 5V, $V_{OUT(MAX)}$ = 5.25V, I_Q = 12 μ A, I_{SD} <1 μ A, 2mm \times 3mm DFN-8 Package

ThinSOT is a trademark of Linear Technology Corporation.