

Product Description

Sirenza Microdevices' SGA-1163 is a Silicon Germanium HBT Heterostructure Bipolar Transistor (SiGe HBT) amplifier that offers excellent isolation and flat gain response for applications to 6 GHz.

This RFIC is a 2-stage design that provides high isolation of up to 40dB at 2 GHz and is fabricated using the latest SiGe HBT 50 GHz F_T process, featuring 1 micron emitters with $V_{ceo} > 7V$.

These unconditionally stable amplifiers have less than 1dB gain drift over 125°C operating range (-40C to +85C) and are ideal for use as buffer amplifiers in oscillator applications covering cellular, ISM and narrowband PCS bands.

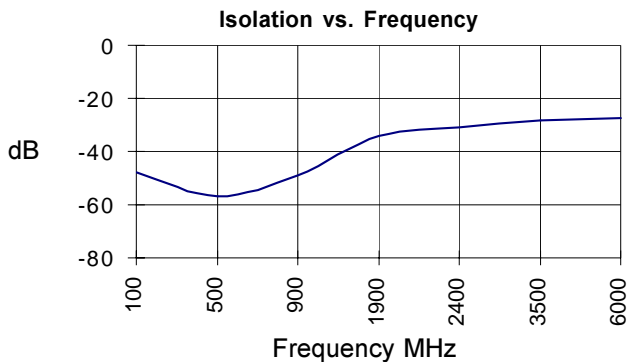

Preliminary

SGA-1163

DC-6000 MHz Silicon Germanium HBT Cascadeable Gain Block

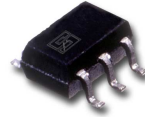

Product Features

- DC-6000 MHz Operation
- Excellent Isolation, >50 dB at 900 MHz
- Single Supply Voltage
- Unconditionally Stable
- 50 Ohms In/Out, Broadband Match for Operation from DC - 6 GHz

Applications

- Buffer Amplifier for Oscillator Applications
- Broadband, High Isolation

Symbol	Parameters: Test Conditions: $Z_0 = 50 \text{ Ohms}$, $I_d = 12 \text{ mA}$, $T = 25^\circ\text{C}$		Units	Min.	Typ.	Max.
P_{1dB}	Output Power at 1dB Compression	$f = 850 \text{ MHz}$ $f = 1950 \text{ MHz}$	dBm dBm		-3.3 -4.6	
S_{21}	Small Signal Gain	$f = \text{DC} - 1000 \text{ MHz}$ $f = 1000 - 2000 \text{ MHz}$ $f = 2000 - 6000 \text{ MHz}$	dB dB dB	10.5	11.7 11.2 9.5	
S_{12}	Reverse Isolation	$f = \text{DC} - 1000 \text{ MHz}$ $f = 1000 - 2000 \text{ MHz}$ $f = 2000 - 6000 \text{ MHz}$	dB dB dB		53.3 38.3 28.5	
S_{11}	Input VSWR	$f = \text{DC} - 2400 \text{ MHz}$ $f = 2400 - 6000 \text{ MHz}$	-		1.3:1 1.8:1	
S_{22}	Output VSWR	$f = \text{DC} - 2400 \text{ MHz}$ $f = 2400 - 6000 \text{ MHz}$	-		2.1:1 2.2:1	
IP_3	Third Order Intercept Point Power out per Tone = -20 dBm	$f = 850 \text{ MHz}$ $f = 1950 \text{ MHz}$	dBm dBm		7.9 6.3	
NF	Noise Figure	$f = \text{DC} - 1000 \text{ MHz}$ $f = 1000 - 2400 \text{ MHz}$	dB dB		3.1 3.4	
T_D	Group Delay	$f = 1000 \text{ MHz}$	pS		118	
V_D	Device Operating Voltage		V	4.2	4.6	5.0
I_D	Device Operating Current		mA	10	12	14

The information provided herein is believed to be reliable at press time. Sirenza Microdevices assumes no responsibility for inaccuracies or omissions. Sirenza Microdevices assumes no responsibility for the use of this information, and all such information shall be entirely at the user's own risk. Prices and specifications are subject to change without notice. No patent rights or licenses to any of the circuits described herein are implied or granted to any third party. Sirenza Microdevices does not authorize or warrant any Sirenza Microdevices product for use in life-support devices and/or systems. Copyright 2001 Sirenza Microdevices, Inc.. All worldwide rights reserved.

Parameter	Specification			Unit	Test Condition
	Min	Typ.	Max.		
Bandwidth Frequency Range	DC		6000	MHz	T= 25C
Device Bias Operating Voltage Operating Current		4.6 12		V mA	T= 25C
500 MHz Gain Noise Figure Output IP3 Output P1dB Input Return Loss Isolation		11.8 3.1 8.7 -3.8 31.9 62.3		dB dB dBm dBm dB dB	T= 25C
850 MHz Gain Noise Figure Output IP3 Output P1dB Input Return Loss Isolation		11.5 3.1 7.9 -3.3 33.1 47.6		dB dB dBm dBm dB dB	T= 25C
1950 MHz Gain Noise Figure Output IP3 Output P1dB Input Return Loss Isolation		11.2 3.4 6.3 -4.6 15.7 34.3		dB dB dBm dBm dB dB	T= 25C
2400 MHz Gain Noise Figure Output IP3 Output P1dB Input Return Loss Isolation		11.4 3.4 5.7 -4.4 17.8 30.2		dB dB dBm dBm dB dB	T= 25C

Absolute Maximum Ratings

Parameter	Absolute Limit
Max. Device Current (I_b)	24 mA
Max. Device Voltage (V_D)	6 V
Max. RF Input Power	-9 dBm
Max. Junction Temp. (T_J)	+150°C
Operating Temp. Range (T_L)	-40°C to +85°C
Max. Storage Temp.	+150°C

Operation of this device beyond any one of these limits may cause permanent damage. For reliable continuous operation, the device voltage and current must not exceed the maximum operating values specified in the table on page one.

Bias conditions should also satisfy the following expression:

$$I_b V_D < (T_J - T_L) / R_{TH}, j-H$$

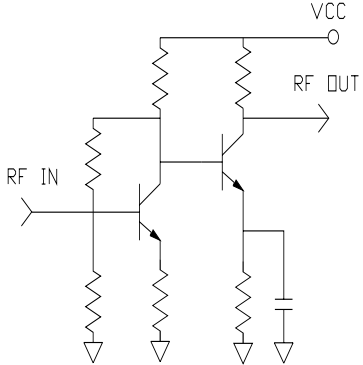
Pin #	Function	Description	Device Schematic
1	GND	Connection to ground. Use via holes for best performance to reduce lead inductance as close to ground leads as possible.	
2	GND	Sames as Pin 1	
3	RF IN	RF input pin. This pin requires the use of an external DC blocking capacitor chosen for the frequency of operation.	
4	Vcc	Supply connection. This pin should be bypassed with a suitable capacitor(s).	
5	GND	Sames as Pin 1	
6	RF OUT	RF output and bias pin. DC voltage is present on this pin, therefore a DC blocking capacitor is necessary for proper operation.	

Application Schematic for +5V Operation at 900 MHz

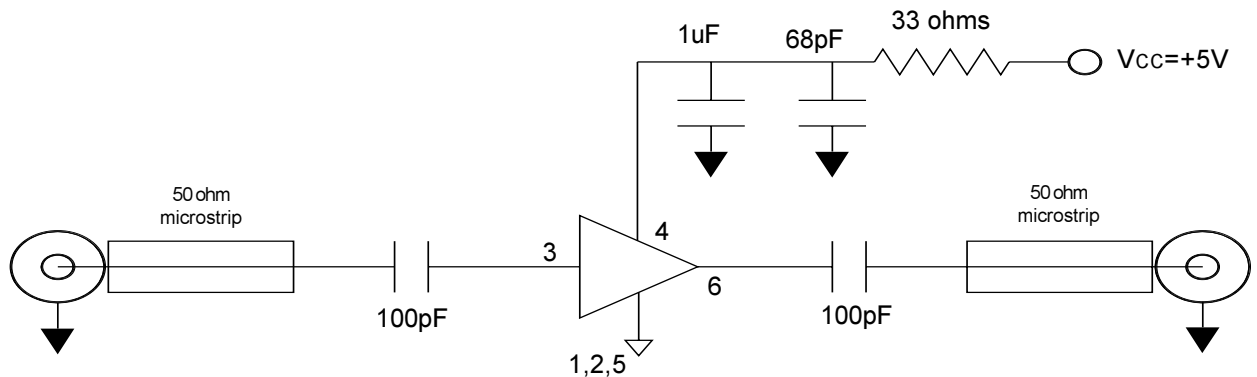

Application Schematic for +5V Operation at 1900 MHz

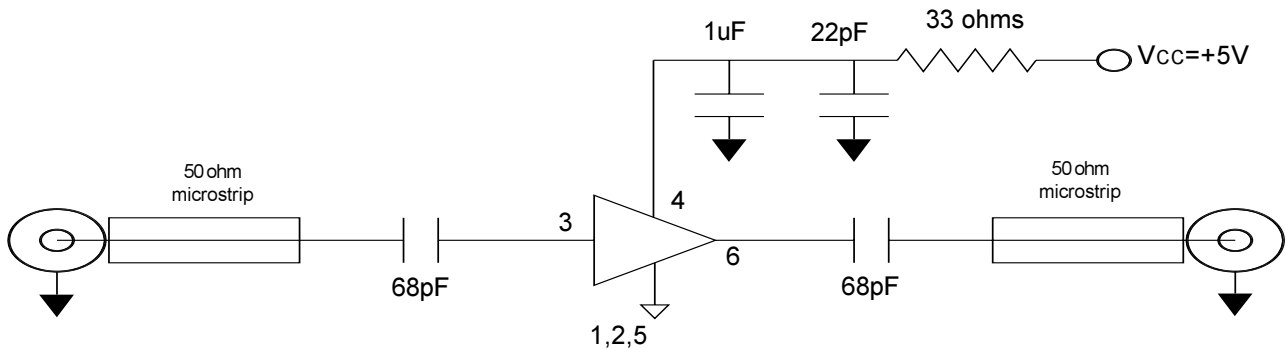

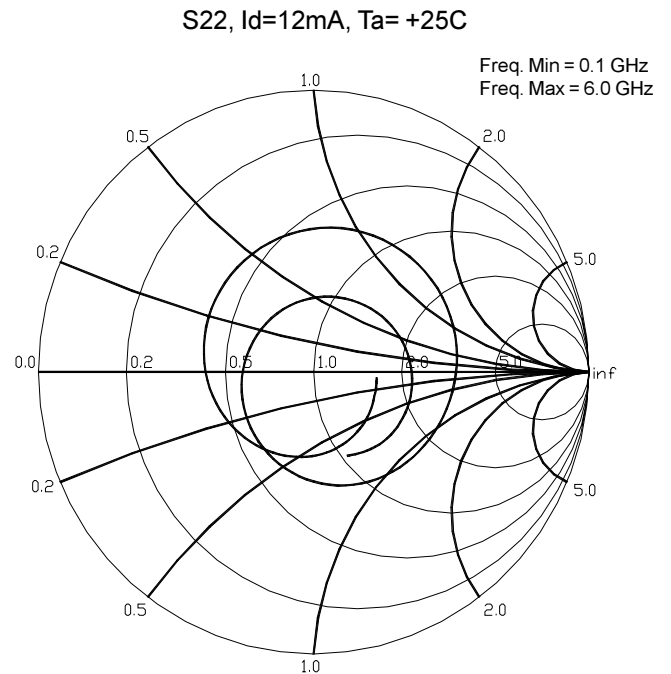
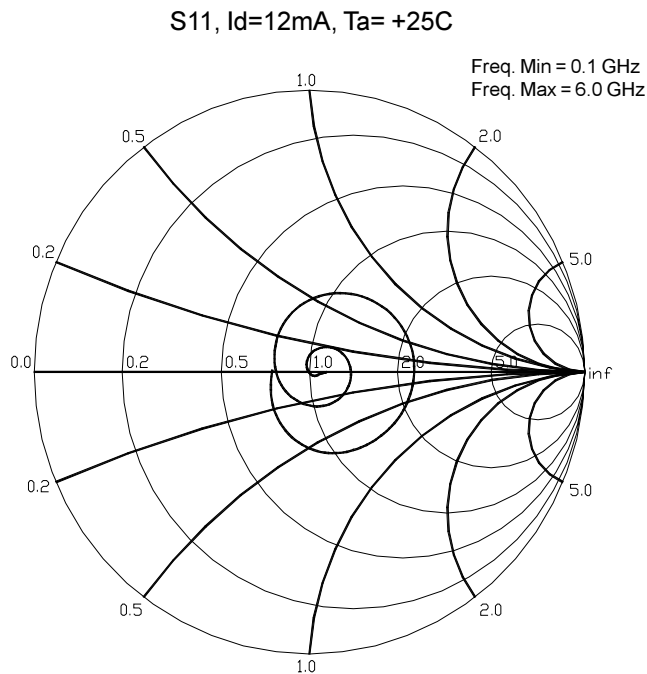
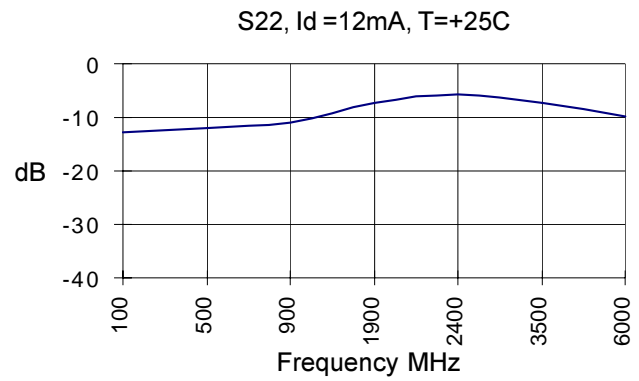
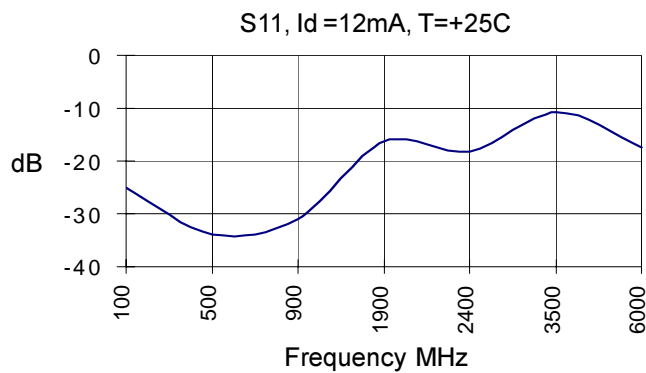
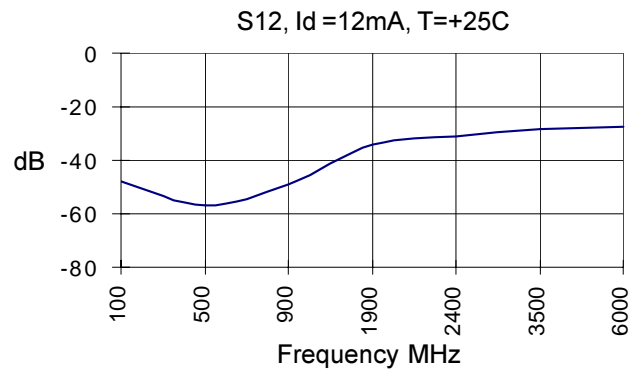
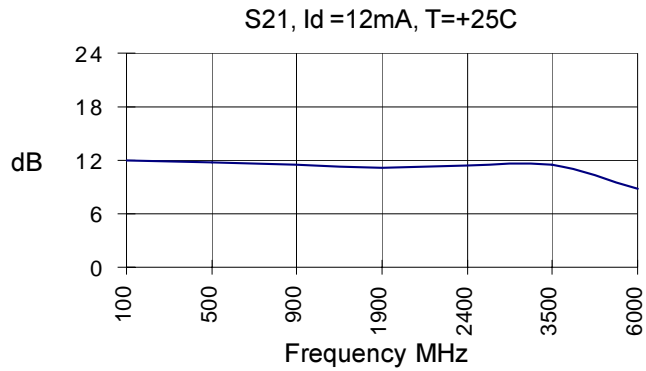

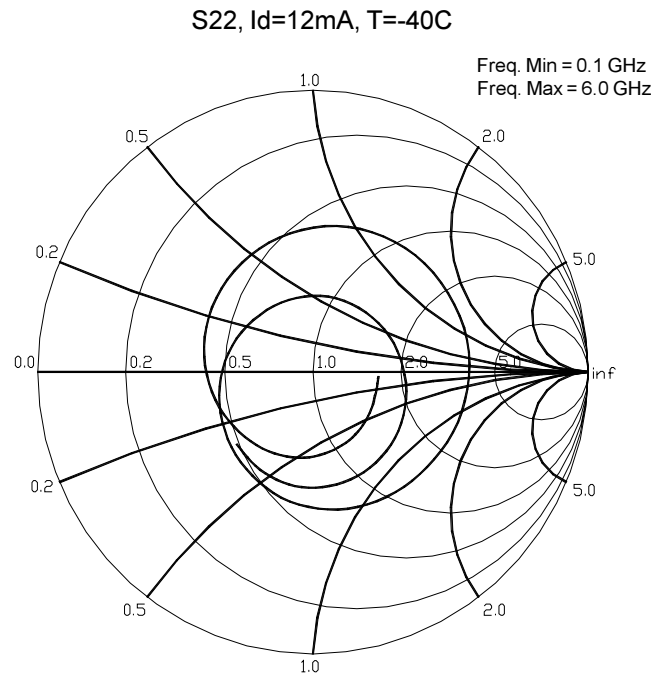
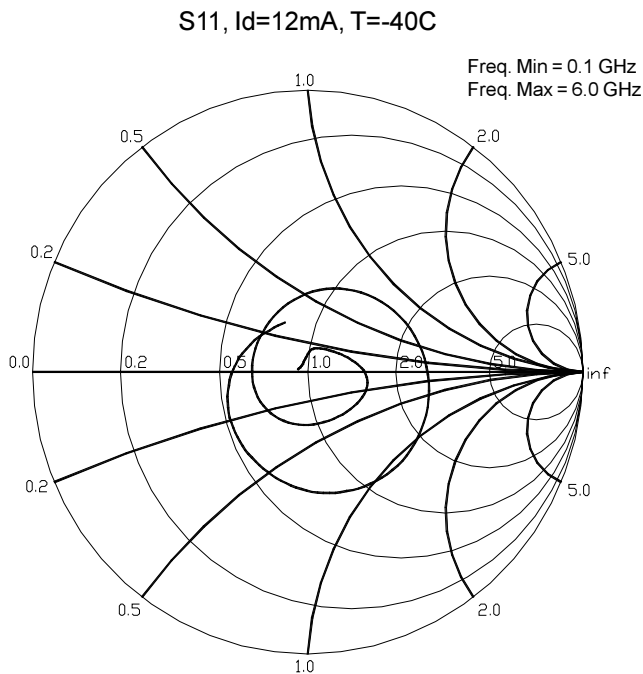
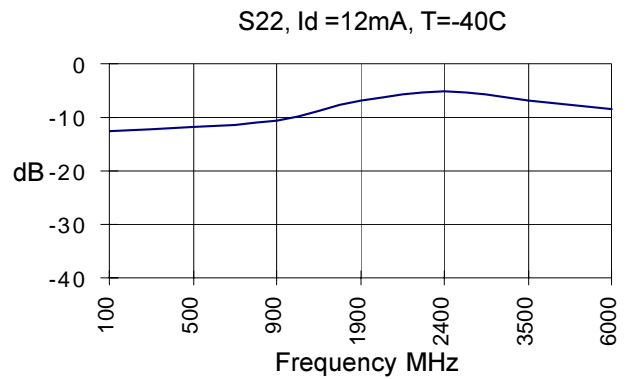
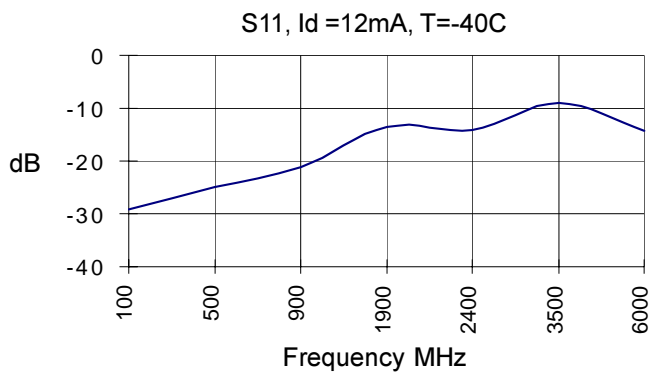
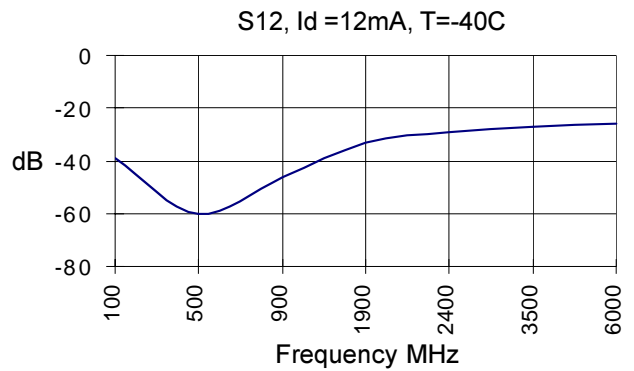
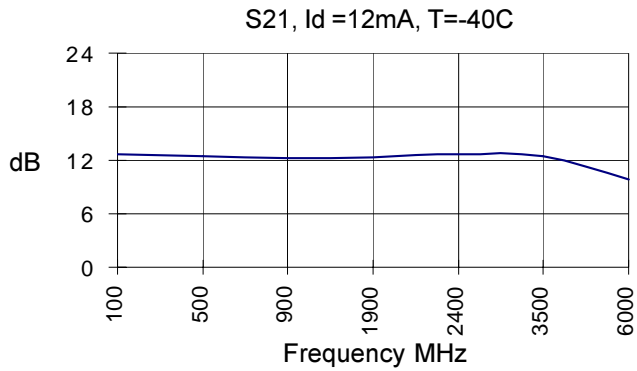

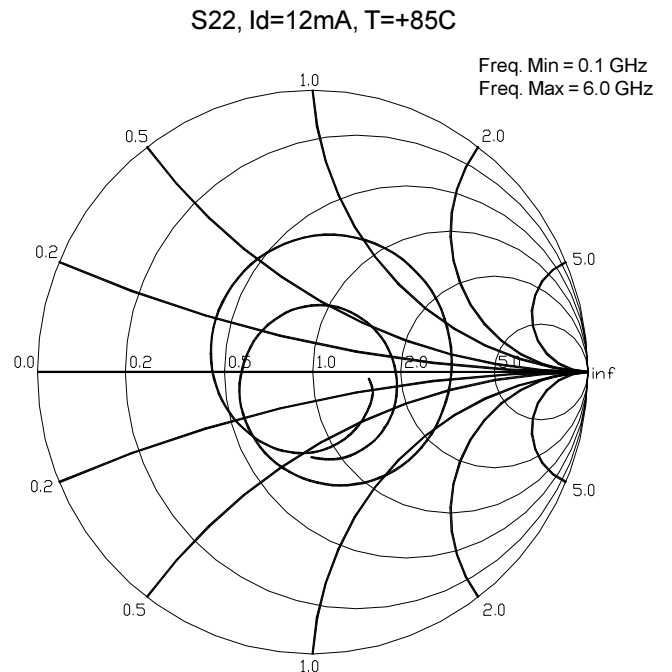
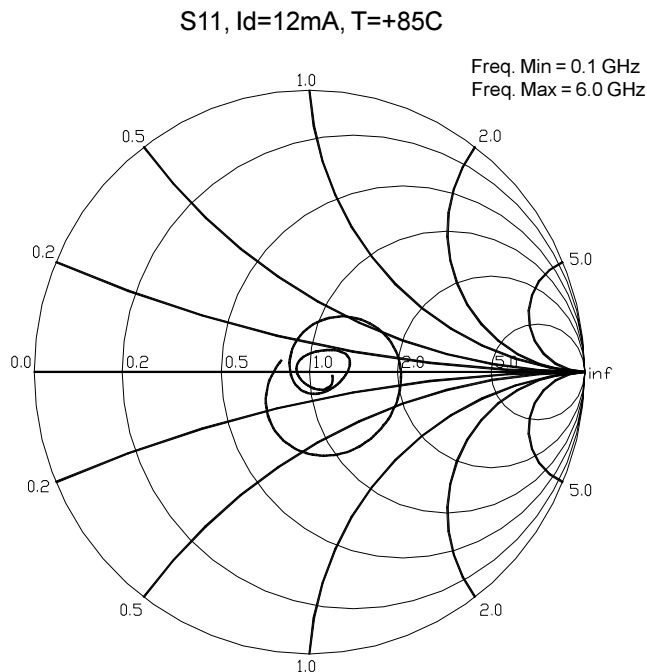
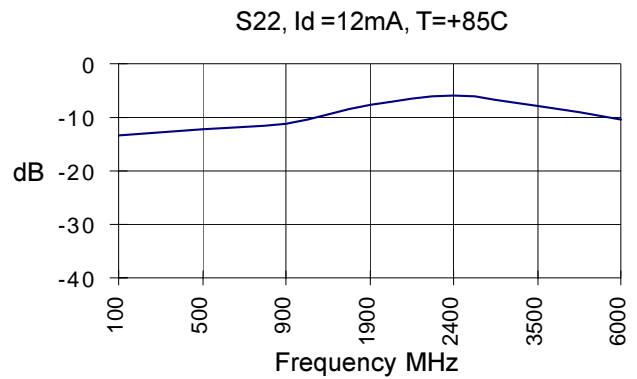
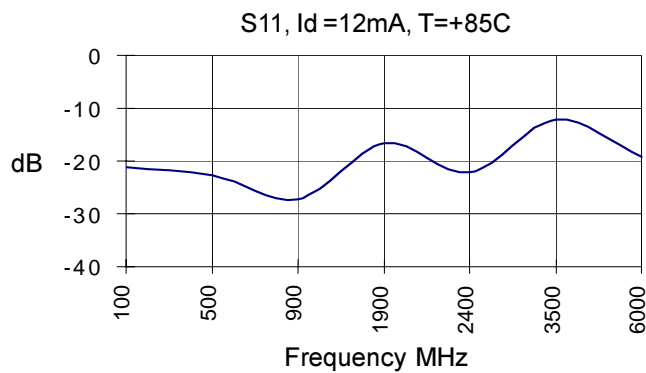
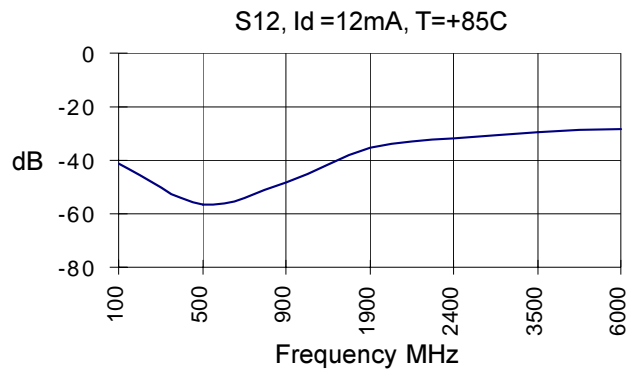
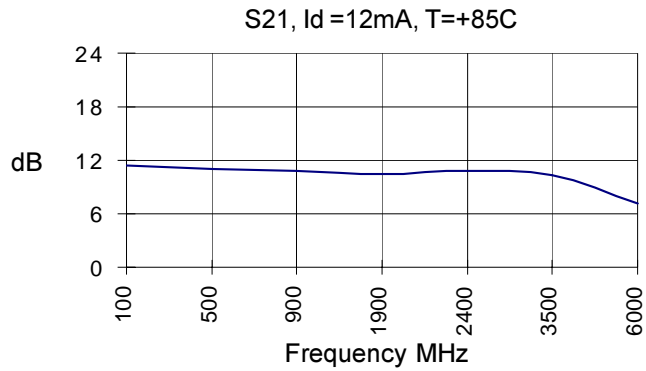

Absolute Maximum Ratings



Caution:

Operation of this device above any one of these parameters may cause permanent damage. Appropriate precautions in handling, packaging and testing devices must be observed.

Thermal Resistance (Lead-Junction):
255° C/W

Preliminary

SGA-1163 DC-6000 MHz 4.6V SiGe Amplifier

Part Number Ordering Information

Part Number	Reel Size	Devices/Reel
SGA-1163-TR1	7"	3000

Recommended Bias Resistor Values					
Supply Voltage(Vs)	5V	6V	7.5V	9V	12V
Rbias (Ohms)	33	117	242	367	617

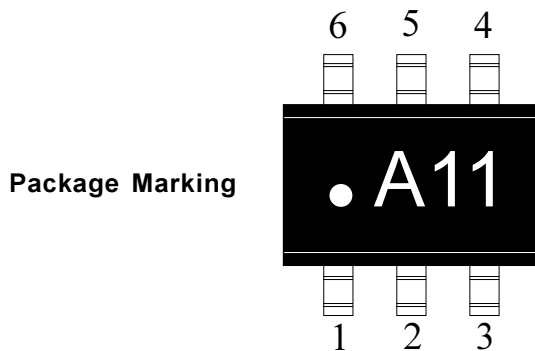

Pin Designation	
1	GND
2	GND
3	RF in
4	Vcc
5	GND
6	RF out

Note: Pin 1 is on lower left when you can read package marking

Package Dimensions

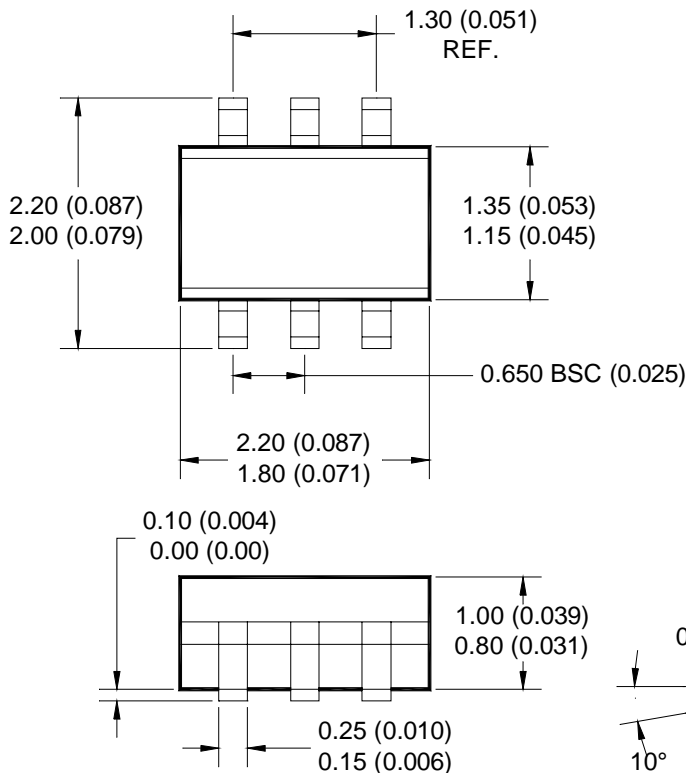

Pad Layout

