

Data Sheet

Description

This wide viewing angle white LED lamp is based on InGaN material technology. A blue LED die is coated by a phosphor to produce white. The typical resulting color is described by the coordinates $x = 0.32$, $y = 0.32$ using the 1931 CIE Chromaticity Diagram.

Benefit

- Reduced Power Consumption, Higher Reliability, and Increased Optical/Mechanical Design Flexibility Compared to Incandescent Bulbs and Other Alternative White Light Sources

Features

Wide viewing angle: 90°

- Flat top
- High intensity InGaN technology

Applications

- Electronic Signs and Signals
- Small Area Illumination
- Legend Backlighting
- General Purpose Indicators

Package Dimensions

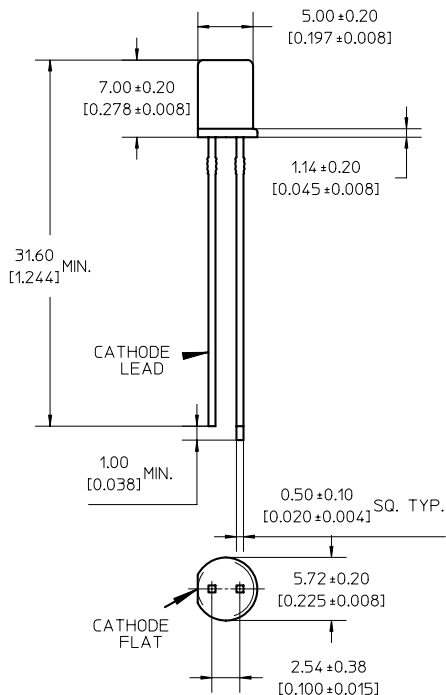

Notes :

1. All dimensions are in millimetres /inches.
2. Epoxy meniscus may extend about 1 mm (0.040") down the leads.

CAUTION : These devices are Class 1C ESD sensitive. Please observe appropriate precautions during handling and processing. Refer to Avago Technologies Application Note AN-1142 for additional details.

Device Selection Guide

Part Number	Min Luminous Intensity Iv (mcd) @ 20mA	Max Luminous Intensity Iv (mcd) @ 20mA
HLMP-FW00-JM0xx	240	680

Tolerance for intensity bin limit is +/-15%

Absolute Maximum Ratings (T_A = 25°C)

Parameter	Value	Units
DC Forward Current ^[1]	30	mA
Peak Forward Current ^[2]	100	mA
Power Dissipation	111	mW
Reverse Voltage (I _R = 10μA)	5	V
LED Junction Temperature	110	°C
Operating Temperature Range	-40 to +85	°C
Storage Temperature Range	-40 to +100	°C

Notes:

1. Derate linearly as shown in Figure 5.
2. Duty factor 10%, 1 KHz.

Electrical Characteristics (T_A = 25°C)

Forward Voltage V _F (V) @ I _F = 20 mA	Reverse Breakdown V _R (V) @ I _R = 10μA	Capacitance C (pF), V _F = 0, f = 1 MHz	Thermal Resistance R _{θJ-PIN} (°C/W)	
Typ.	Max.	Min.	Typ.	Typ.
3.2	3.7	5	70	240

Optical Characteristics (T_A = 25°C)

Typical Chromaticity Coordinates ^[1]		Viewing Angle 2θ _{1/2} Degrees ^[2] Typ.
x	y	
0.32	0.32	90°

Notes:

1. The chromaticity coordinates are derived from the CIE 1931 Chromaticity Diagram and represent the perceived color of the device.
2. θ_{1/2} is the off-axis angle where the luminous intensity is ½ the peak intensity.

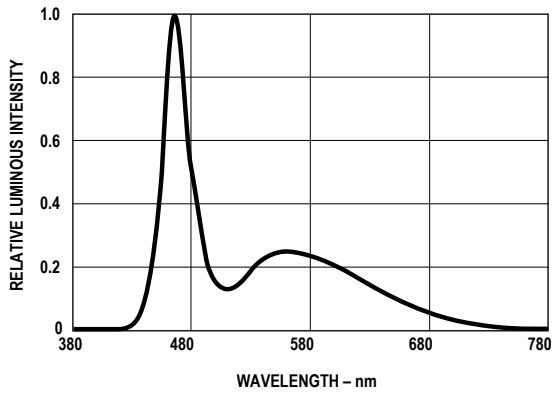

Figure 1. Relative Intensity vs Wavelength

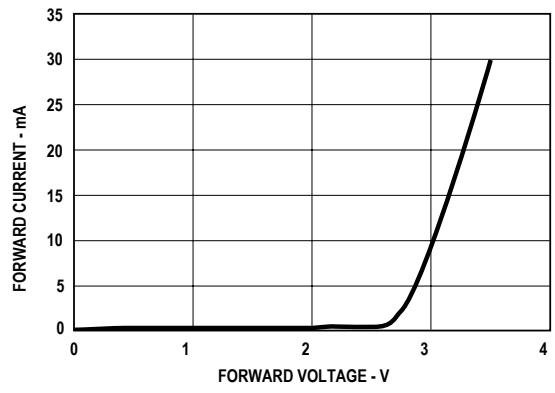

Figure 2. Forward Current vs Forward Voltage

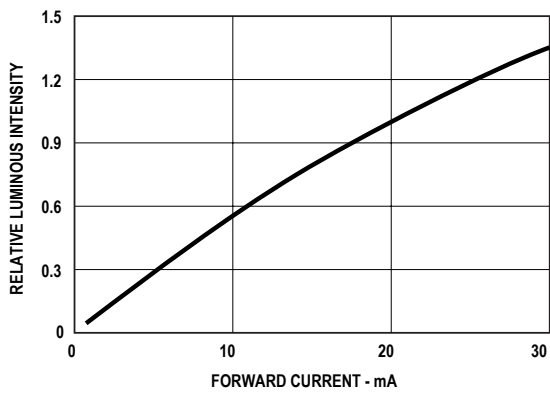

Figure 3. Relative Iv vs. Forward Current

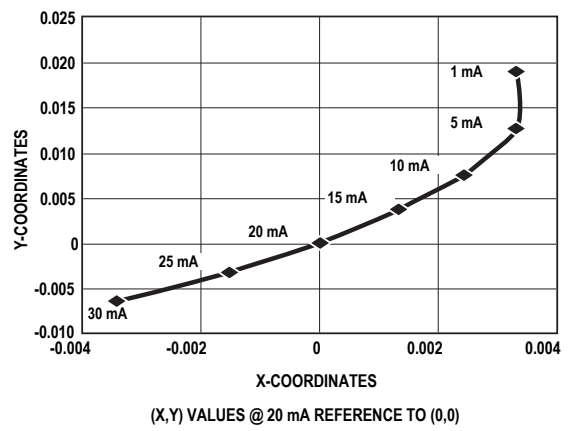

Figure 4. Chromaticity shift vs. current

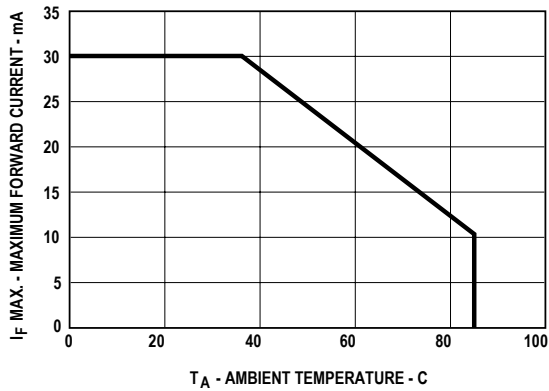

Figure 5. Maximum Fwd. Current vs Temperature

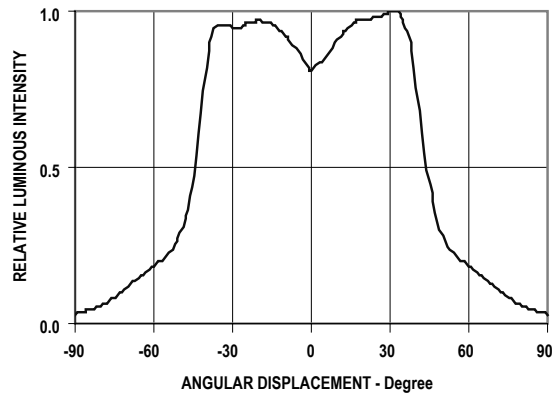

Figure 6. Spatial Radiation Pattern

Intensity Bin Limits (mcd at 20 mA)

Bin	Min.	Max.
J	240	310
K	310	400
L	400	520
M	520	680

Tolerance for each bin limit is $\pm 15\%$

Color Bin Limit Tables

Rank	Limits (Chromaticity Coordinates)				
1	x	0.330	0.330	0.356	0.361
	y	0.360	0.318	0.351	0.385
2	x	0.287	0.296	0.330	0.330
	y	0.295	0.276	0.318	0.339
3	x	0.264	0.280	0.296	0.283
	y	0.267	0.248	0.276	0.305
4	x	0.283	0.287	0.330	0.330
	y	0.305	0.295	0.339	0.360

Tolerance for each bin limit is ± 0.01

Relative Light Output vs. Junction Temperature

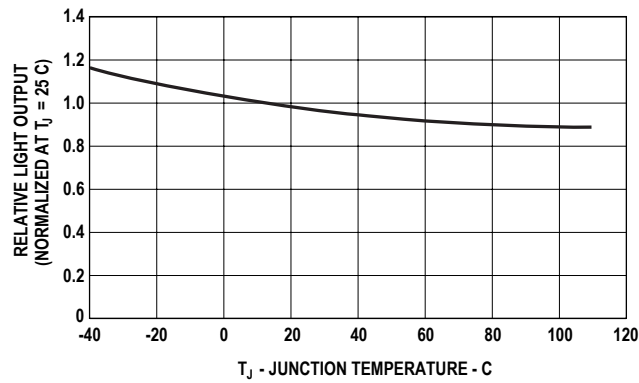

Color Bin Limits with Respect to CIE 1931 Chromaticity Diagram

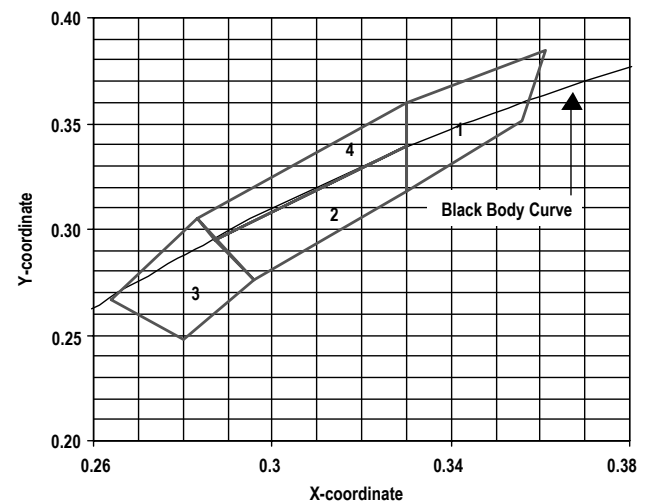

Note:

1. Bin categories are established for classification of products. Products may not be available in all bin categories. Please contact your Avago representative for information on currently available

Precautions:

Lead Forming:

- The leads of an LED lamp may be preformed or cut to length prior to insertion and soldering into PC board.
- If lead forming is required before soldering, care must be taken to avoid any excessive mechanical stress induced to LED package. Otherwise, cut the leads of LED to length after soldering process at room temperature. The solder joint formed will absorb the mechanical stress of the lead cutting from traveling to the LED chip die attach and wirebond.
- It is recommended that tooling made to precisely form and cut the leads to length rather than rely upon hand operation.

Soldering Condition:

- Care must be taken during PCB assembly and soldering process to prevent damage to LED component.
- The closest LED is allowed to solder on board is 1.59mm below the body (encapsulant epoxy) for those parts without standoff.
- Recommended soldering condition:

	Wave Soldering	Manual Solder Dipping
Pre-heat temperature	105 °C Max.	-
Preheat time	30 sec Max	-
Peak temperature	250 °C Max.	260 °C Max.
Dwell time	3 sec Max.	5 sec Max

- Wave soldering parameter must be set and maintain according to recommended temperature and dwell time in the solder wave. Customer is advised to periodically check on the soldering profile to ensure the soldering profile used is always conforming to recommended soldering condition.
- If necessary, use fixture to hold the LED component in proper orientation with respect to the PCB during soldering process.
- Proper handling is imperative to avoid excessive thermal stresses to LED components when heated. Therefore, the soldered PCB must be allowed to cool to room temperature, 25°C before handling.
- Special attention must be given to board fabrication, solder masking, surface plating and lead holes size and component orientation to assure solderability.
- Recommended PC board plated through holes

LED component lead size	Diagonal	Plated through hole diameter
0.457 x 0.457mm (0.018 x 0.018inch)	0.646 mm (0.025 inch)	0.976 to 1.078 mm (0.038 to 0.042 inch)
0.508 x 0.508mm (0.020 x 0.020inch)	0.718 mm (0.028 inch)	1.049 to 1.150mm (0.041 to 0.045 inch)

Note: Refer to application note AN1027 for more information on soldering LED components.

Recommended Wave Soldering Profile

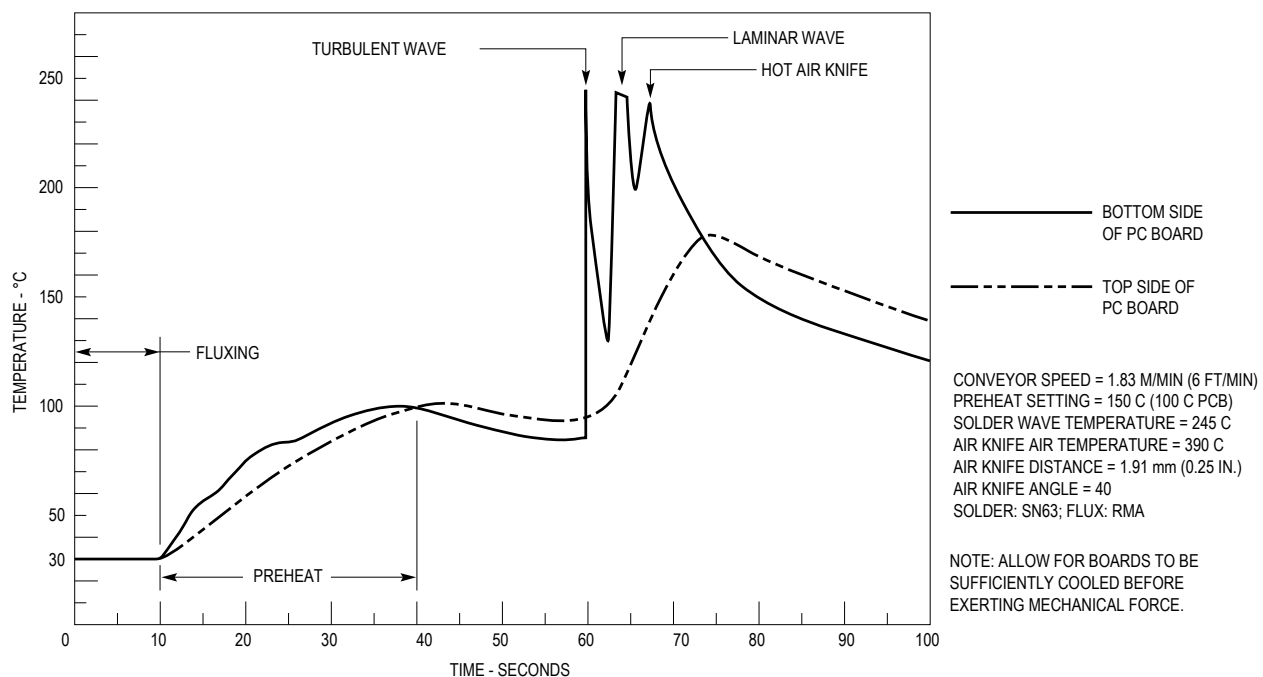

DISCLAIMER: AVAGO'S PRODUCTS AND SOFTWARE ARE NOT SPECIFICALLY DESIGNED, MANUFACTURED OR AUTHORIZED FOR SALE AS PARTS, COMPONENTS OR ASSEMBLIES FOR THE PLANNING, CONSTRUCTION, MAINTENANCE OR DIRECT OPERATION OF A NUCLEAR FACILITY OR FOR USE IN MEDICAL DEVICES OR APPLICATIONS. CUSTOMER IS SOLELY RESPONSIBLE, AND WAIVES ALL RIGHTS TO MAKE CLAIMS AGAINST AVAGO OR ITS SUPPLIERS, FOR ALL LOSS, DAMAGE, EXPENSE OR LIABILITY IN CONNECTION WITH SUCH USE.

For product information and a complete list of distributors, please go to our web site: www.avagotech.com

Avago, Avago Technologies, and the A logo are trademarks of Avago Technologies, Limited in the United States and other countries.
Data subject to change. Copyright © 2007 Avago Technologies Limited. All rights reserved. Obsoletes 5989-4143EN
AV02-0425EN - May 15, 2007

