

## FEATURES

- 3.5MSPS Conversion Rate
- 74.2dB SINAD at 14-Bits, 71.1dB SINAD at 12-Bits
- Low Power Dissipation: 18mW
- 3.3V Single Supply Operation
- 2.5V Internal Bandgap Reference can be Overdriven
- 3-Wire SPI-Compatible Serial Interface
- Sleep (13 $\mu$ W) Shutdown Mode
- Nap (4mW) Shutdown Mode
- 80dB Common Mode Rejection
- 0V to 2.5V Unipolar Input Range
- Tiny 10-Lead MSOP Package

## APPLICATIONS

- Communications
- Data Acquisition Systems
- Uninterrupted Power Supplies
- Multiphase Motor Control
- Multiplexed Data Acquisition
- RFID

## DESCRIPTION

The LTC<sup>®</sup>2355-12/LTC2355-14 are 12-bit/14-bit, 3.5MSPS serial ADCs with differential inputs. The devices draw only 5.5mA from a single 3.3V supply and come in a tiny 10-lead MSOP package. A Sleep shutdown feature further reduces power consumption to 13 $\mu$ W. The combination of speed, low power and tiny package makes the LTC2355-12/LTC2355-14 suitable for high speed, portable applications.

The 80dB common mode rejection allows users to eliminate ground loops and common mode noise by measuring signals differentially from the source.

The devices convert 0V to 2.5V unipolar inputs differentially. The absolute voltage swing for  $A_{IN}^+$  and  $A_{IN}^-$  extends from ground to the supply voltage.

The serial interface sends out the conversion results during the 16 clock cycles following a CONV rising edge for compatibility with standard serial interfaces. If two additional clock cycles for acquisition time are allowed after the data stream in between conversions, the full sampling rate of 3.5MSPS can be achieved with a 63MHz clock.

LT, LT, LTC, LTM, Linear Technology and the Linear logo are registered trademarks of Linear Technology Corporation. All other trademarks are the property of their respective owners.

## BLOCK DIAGRAM

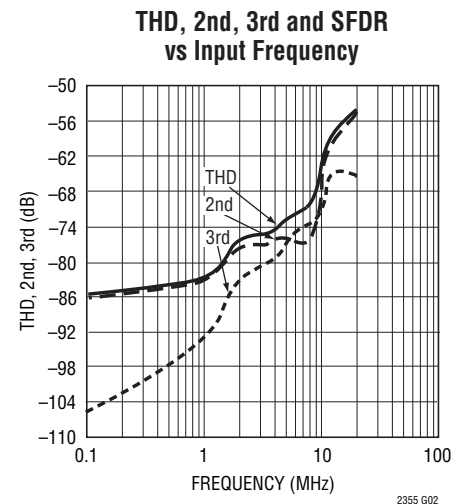
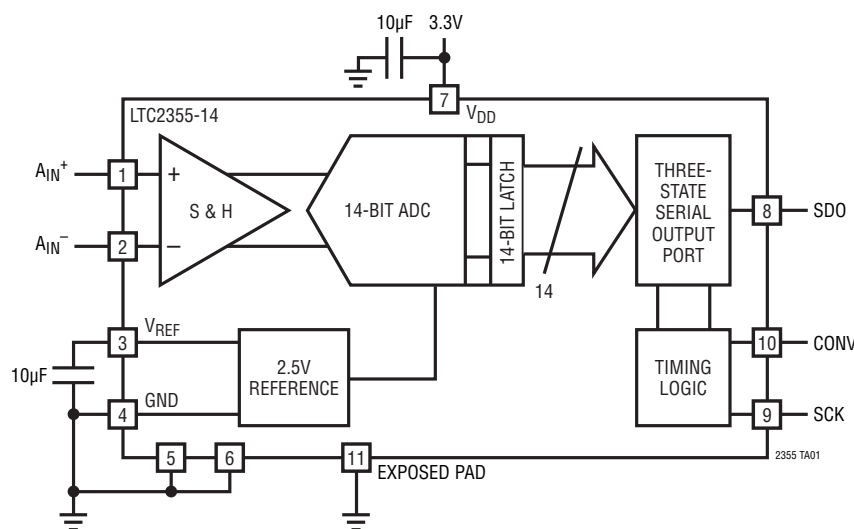

# LTC2355-12/LTC2355-14

## ABSOLUTE MAXIMUM RATINGS

(Notes 1, 2)

Supply Voltage ( $V_{DD}$ )	4V
Analog and $V_{REF}$ Input Voltages	
(Note 3)	-0.3V to ( $V_{DD} + 0.3V$ )
Digital Input Voltages	-0.3V to ( $V_{DD} + 0.3V$ )
Digital Output Voltage	-0.3V to ( $V_{DD} + 0.3V$ )
Power Dissipation	100mW
Operation Temperature Range	
LTC2355C-12/LTC2355C-14	0°C to 70°C
LTC2355I-12/LTC2355I-14	-40°C to 85°C
Storage Temperature Range	-65°C to 150°C
Lead Temperature (Soldering, 10 sec)	300°C

## PIN CONFIGURATION

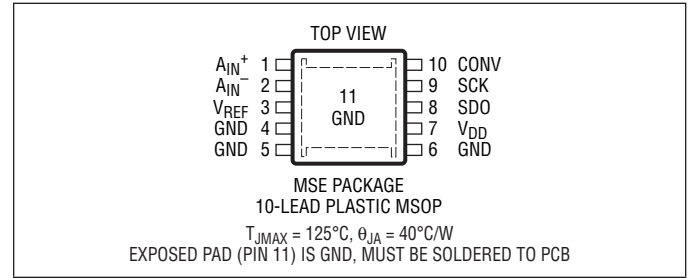

## ORDER INFORMATION

LEAD FREE FINISH	TAPE AND REEL	PART MARKING*	PACKAGE DESCRIPTION	TEMPERATURE RANGE
LTC2355CMSE-12#PBF	LTC2355CMSE-12#TRPBF	LTCVX	10-Lead Plastic MSOP	0°C to 70°C
LTC2355IMSE-12#PBF	LTC2355IMSE-12#TRPBF	LTCVX	10-Lead Plastic MSOP	-40°C to 85°C
LTC2355CMSE-14#PBF	LTC2355CMSE-14#TRPBF	LTCVY	10-Lead Plastic MSOP	0°C to 70°C
LTC2355IMSE-14#PBF	LTC2355IMSE-14#TRPBF	LTCVY	10-Lead Plastic MSOP	-40°C to 85°C

Consult LTC Marketing for parts specified with wider operating temperature ranges. \*The temperature grade is identified by a label on the shipping container. Consult LTC Marketing for information on non-standard lead based finish parts.

For more information on lead free part marking, go to: <http://www.linear.com/leadfree/>

For more information on tape and reel specifications, go to: <http://www.linear.com/tapeandree/>

## CONVERTER CHARACTERISTICS

The ● denotes the specifications which apply over the full operating temperature range, otherwise specifications are at  $T_A = 25^\circ\text{C}$ . With internal reference.  $V_{DD} = 3.3V$ .

PARAMETER	CONDITIONS		LTC2355-12			LTC2355-14			UNITS
			MIN	TYP	MAX	MIN	TYP	MAX	
Resolution (No Missing Codes)		●	12			14			Bits
Integral Linearity Error	(Notes 4, 5, 18)	●	-2	±0.25	2	-4	±0.5	4	LSB
Offset Error	(Notes 4, 18)	●	-10	±1	10	-20	±2	20	LSB
Gain Error	(Note 4, 18)	●	-30	±5	30	-80	±10	80	LSB
Gain Tempco	Internal Reference (Note 4)			±15			±15		ppm/°C
	External Reference			±1			±1		ppm/°C

2355fa

## ANALOG INPUT

The ● denotes the specifications which apply over the full operating temperature range, otherwise specifications are at  $T_A = 25^\circ\text{C}$ . With internal reference.  $V_{DD} = 3.3\text{V}$ .

SYMBOL	PARAMETER	CONDITIONS	MIN	TYP	MAX	UNITS
$V_{IN}$	Analog Differential Input Range (Notes 3, 8, 9)	$3.1\text{V} \leq V_{DD} \leq 3.6\text{V}$	●	0 to 2.5		V
$V_{CM}$	Analog Common Mode + Differential Input Range (Note 10)			0 to $V_{DD}$		V
$I_{IN}$	Analog Input Leakage Current		●		1	$\mu\text{A}$
$C_{IN}$	Analog Input Capacitance	(Note 19)		13		pF
$t_{ACQ}$	Sample-and-Hold Acquisition Time	(Note 6)	●		39	ns
$t_{AP}$	Sample-and-Hold Aperture Delay Time			1		ns
$t_{JITTER}$	Sample-and-Hold Aperture Delay Time Jitter			0.3		ps
CMRR	Analog Input Common Mode Rejection Ratio	$f_{IN} = 1\text{MHz}$ , $V_{IN} = 0\text{V}$ to $3\text{V}$ $f_{IN} = 100\text{MHz}$ , $V_{IN} = 0\text{V}$ to $3\text{V}$		-60		dB
				-15		dB

## DYNAMIC ACCURACY

The ● denotes the specifications which apply over the full operating temperature range, otherwise specifications are at  $T_A = 25^\circ\text{C}$  with external reference = 2.55V.  $V_{DD} = 3.3\text{V}$ .

SYMBOL	PARAMETER	CONDITIONS	LTC2355-12			LTC2355-14			UNITS
			MIN	TYP	MAX	MIN	TYP	MAX	
SINAD	Signal-to-Noise Plus Distortion Ratio	100kHz Input Signal		71.1			74.2		dB
		1.4MHz Input Signal	●	69	71.1		71	73.8	dB
THD	Total Harmonic Distortion	100kHz First 5 Harmonics		-86			-86		dB
		1.4MHz First 5 Harmonics	●	-82	-76		-82	-78	dB
SFDR	Spurious Free Dynamic Range	100kHz Input Signal		86			86		dB
		1.4MHz Input Signal		82			82		dB
IMD	Intermodulation Distortion	1.25V to 2.5V 1.25MHz into $A_{IN}^+$ , 0V to 1.25V, 1.2MHz into $A_{IN}^-$		-82			-82		dB
									dB
	Code-to-Code Transition Noise	$V_{REF} = 2.5\text{V}$ (Note 18)		0.25			1		$\text{LSB}_{RMS}$
	Full Power Bandwidth	$V_{IN} = 2.5\text{V}_{P-P}$ , $\text{SDO} = 11585\text{LSB}_{P-P}$ (Note 15)		50			50		MHz
	Full Linear Bandwidth	$S/(N + D) \geq 68\text{dB}$		5			5		MHz

## INTERNAL REFERENCE CHARACTERISTICS

The ● denotes the specifications which apply over the full operating temperature range, otherwise specifications are at  $T_A = 25^\circ\text{C}$ ,  $V_{DD} = 3.3\text{V}$ .

PARAMETER	CONDITIONS	MIN	TYP	MAX	UNITS
$V_{REF}$ Output Voltage	$I_{OUT} = 0$		2.5		V
$V_{REF}$ Output Tempco			15		ppm/ $^\circ\text{C}$
$V_{REF}$ Line Regulation	$V_{DD} = 3.1\text{V}$ to $3.6\text{V}$ , $V_{REF} = 2.5\text{V}$		600		$\mu\text{V}/\text{V}$
$V_{REF}$ Output Resistance	Load Current = 0.5mA		0.2		$\Omega$
$V_{REF}$ Settling Time	$C_{REF} = 10\mu\text{F}$		2		ms
External $V_{REF}$ Input Range		2.55		$V_{DD}$	V

## DIGITAL INPUTS AND DIGITAL OUTPUTS

The ● denotes the specifications which apply over the full operating temperature range, otherwise specifications are at  $T_A = 25^\circ\text{C}$ ,  $V_{DD} = 3.3\text{V}$ .

SYMBOL	PARAMETER	CONDITIONS	MIN	TYP	MAX	UNITS
$V_{IH}$	High Level Input Voltage	$V_{DD} = 3.6\text{V}$	● 2.4			V
$V_{IL}$	Low Level Input Voltage	$V_{DD} = 3.1\text{V}$	●		0.6	V
$I_{IN}$	Digital Input Current	$V_{IN} = 0\text{V to } V_{DD}$	●		$\pm 10$	$\mu\text{A}$
$C_{IN}$	Digital Input Capacitance			5		pF
$V_{OH}$	High Level Output Voltage	$V_{DD} = 3.3\text{V}$ , $I_{OUT} = -200\mu\text{A}$	● 2.5	2.9		V
$V_{OL}$	Low Level Output Voltage	$V_{DD} = 3.1\text{V}$ , $I_{OUT} = 160\mu\text{A}$ $V_{DD} = 3.1\text{V}$ , $I_{OUT} = 1.6\text{mA}$	●	0.05 0.10	0.4	V V
$I_{OZ}$	Hi-Z Output Leakage $D_{OUT}$	$V_{OUT} = 0\text{V to } V_{DD}$	●		$\pm 10$	$\mu\text{A}$
$C_{OZ}$	Hi-Z Output Capacitance $D_{OUT}$			1		pF
$I_{SOURCE}$	Output Short-Circuit Source Current	$V_{OUT} = 0\text{V}$ , $V_{DD} = 3.3\text{V}$		20		mA
$I_{SINK}$	Output Short-Circuit Sink Current	$V_{OUT} = V_{DD} = 3.3\text{V}$		15		mA

## POWER REQUIREMENTS

The ● denotes the specifications which apply over the full operating temperature range, otherwise specifications are at  $T_A = 25^\circ\text{C}$ . (Note 17)

SYMBOL	PARAMETER	CONDITIONS	MIN	TYP	MAX	UNITS
$V_{DD}$	Supply Voltage		3.1	3.3	3.6	V
$I_{DD}$	Supply Current	Active Mode	●	5.5	8	mA
		Nap Mode	●	1.1	1.5	mA
		Sleep Mode (LTC2355-12)		4	15	$\mu\text{A}$
		Sleep Mode (LTC2355-14)		4	12	$\mu\text{A}$
$P_D$	Power Dissipation			18		mW

## TIMING CHARACTERISTICS

The ● denotes the specifications which apply over the full operating temperature range, otherwise specifications are at  $T_A = 25^\circ\text{C}$ .  $V_{DD} = 3.3\text{V}$ .

SYMBOL	PARAMETER	CONDITIONS	MIN	TYP	MAX	UNITS
$f_{\text{SAMPLE(MAX)}}$	Maximum Sampling Rate per Channel (Conversion Rate)		● 3.5			MHz
$t_{\text{THROUGHPUT}}$	Minimum Sampling Period (Conversion + Acquisition Period)				● 286	ns
$t_{\text{SCK}}$	Clock Period	(Note 16)	● 15.872		10000	ns
$t_{\text{CONV}}$	Conversion Time	(Note 6)	16	18		SCLK cycles
$t_1$	Minimum High or Low SCLK Pulse Width	(Note 6)	2			ns
$t_2$	CONV to SCK Setup Time	(Notes 6, 10)	3			ns
$t_3$	Nearest SCK Edge Before CONV	(Note 6)	0			ns
$t_4$	Minimum High or Low CONV Pulse Width	(Note 6)	4			ns
$t_5$	SCK↑ to Sample Mode	(Note 6)	4			ns
$t_6$	CONV↑ to Hold Mode	(Notes 6, 11)	1.2			ns
$t_7$	16th SCK↑ to CONV↑ Interval (Affects Acquisition Period)	(Notes 6, 7, 13)	45			ns
$t_8$	Delay from SCK to Valid Bits 0 Through 13	(Notes 6, 12)			8	ns
$t_9$	SCK↑ to Hi-Z at SDO	(Notes 6, 12)			6	ns
$t_{10}$	Previous SDO Bit Remains Valid After SCK	(Notes 6, 12)	2			ns
$t_{12}$	$V_{\text{REF}}$ Settling Time After Sleep-to-Wake Transition	(Note 14)		2		ms

**Note 1:** Stresses beyond those listed under Absolute Maximum Ratings may cause permanent damage to the device. Exposure to any Absolute Maximum Rating condition for extended periods may affect device reliability and lifetime.

**Note 2:** All voltage values are with respect to GND.

**Note 3:** When these pins are taken below GND or above  $V_{DD}$ , they will be clamped by internal diodes. This product can handle input currents greater than 100mA below GND or greater than  $V_{DD}$  without latchup.

**Note 4:** Offset and full-gain specifications are measured for a single-ended  $A_{\text{IN}^+}$  input with  $A_{\text{IN}^-}$  grounded and using the internal 2.5V reference.

**Note 5:** Integral linearity is tested with an external 2.55V reference and is defined as the deviation of a code from the straight line passing through the actual endpoints of a transfer curve. The deviation is measured from the center of quantization band.

**Note 6:** Guaranteed by design, not subject to test.

**Note 7:** Recommended operating conditions.

**Note 8:** The analog input range is defined for the voltage difference between  $A_{\text{IN}^+}$  and  $A_{\text{IN}^-}$ .

**Note 9:** The absolute voltage at  $A_{\text{IN}^+}$  and  $A_{\text{IN}^-}$  must be within this range.

**Note 10:** If less than 3ns is allowed, the output data will appear one clock cycle later. It is best for CONV to rise half a clock before SCK, when running the clock at rated speed.

**Note 11:** Not the same as aperture delay. Aperture delay is smaller (1ns) because the 2.2ns delay through the sample-and-hold is subtracted from the CONV to Hold mode delay.

**Note 12:** The rising edge of SCK is guaranteed to catch the data coming out into a storage latch.

**Note 13:** The time period for acquiring the input signal is started by the 16th rising clock and it is ended by the rising edge of convert.

**Note 14:** The internal reference settles in 2ms after it wakes up from Sleep mode with one or more cycles at SCK and a 10 $\mu\text{F}$  capacitive load.

**Note 15:** The full power bandwidth is the frequency where the output code swing drops to 3dB with a 2.5V<sub>P-P</sub> input sine wave.

**Note 16:** Maximum clock period guarantees analog performance during conversion. Output data can be read with an arbitrarily long clock.

**Note 17:**  $V_{DD} = 3.3\text{V}$ ,  $f_{\text{SAMPLE}} = 3.5\text{MSPS}$ .

**Note 18:** The LTC2355-14 is measured and specified with 14-bit resolution (1LSB = 152 $\mu\text{V}$ ) and the LTC2355-12 is measured and specified with 12-bit resolution (1LSB = 610 $\mu\text{V}$ ).

**Note 19:** The sampling capacitor at each input accounts for 4.1pF of the input capacitance.

## TYPICAL PERFORMANCE CHARACTERISTICS $T_A = 25^\circ\text{C}$ , $V_{DD} = 3.3\text{V}$ (LTC2355-14)

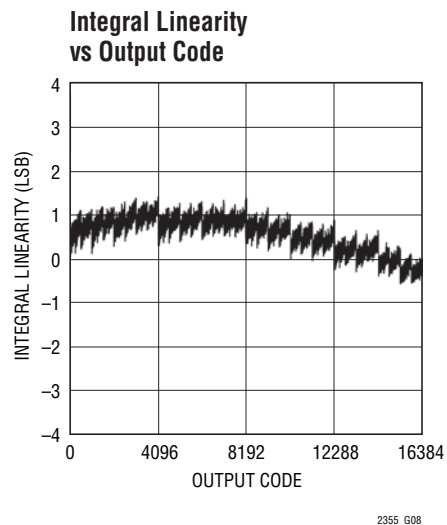
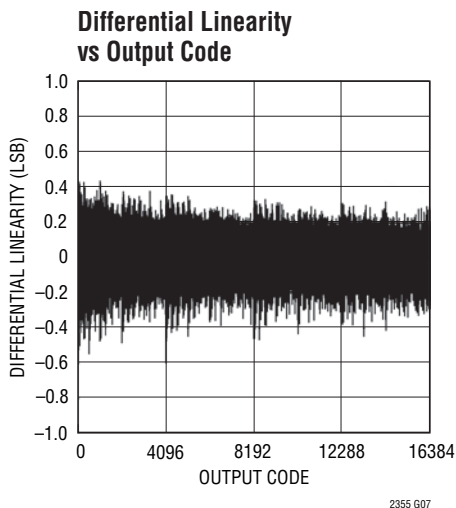
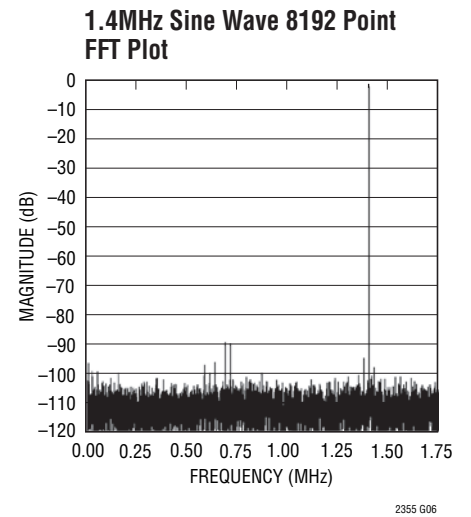
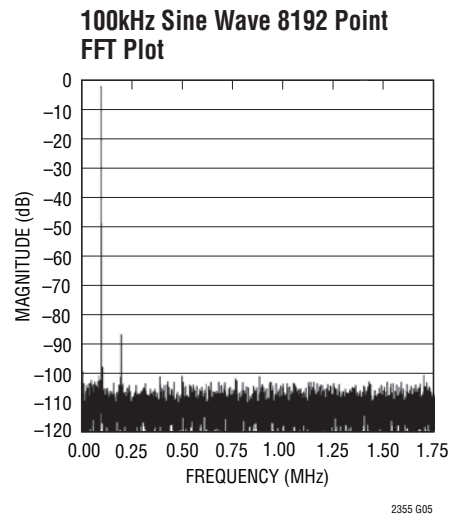
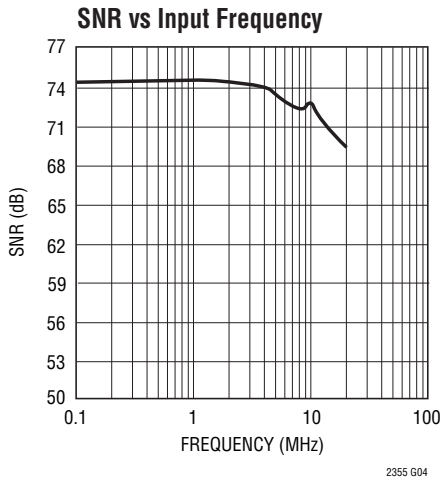
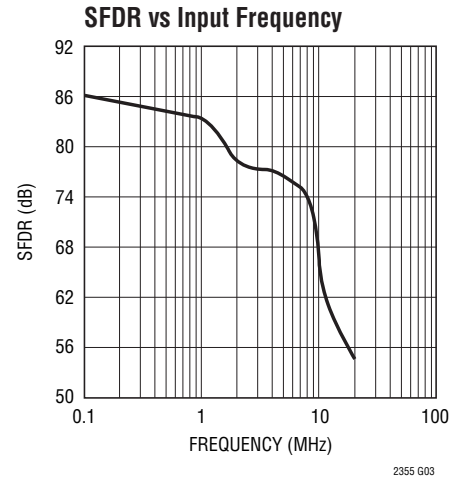
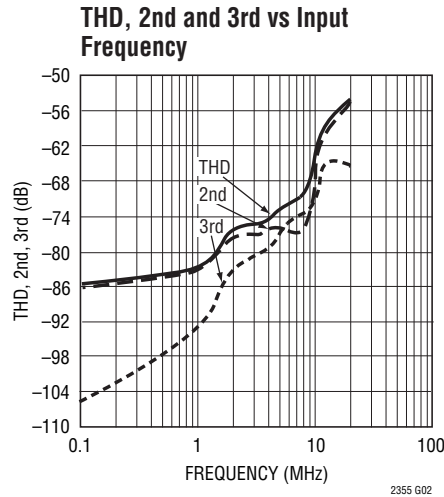
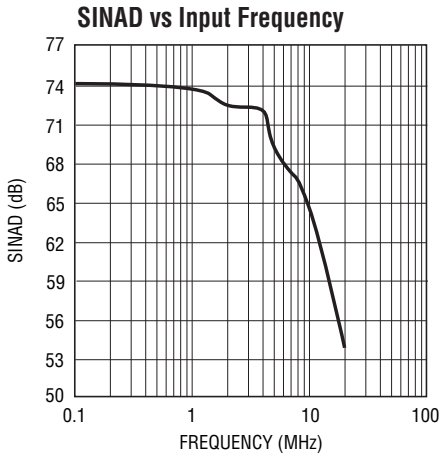

## TYPICAL PERFORMANCE CHARACTERISTICS $T_A = 25^\circ\text{C}$ , $V_{DD} = 3.3\text{V}$ (LTC2355-14)

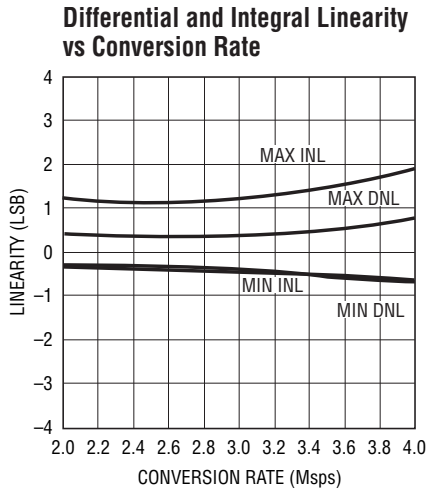

2355 G09

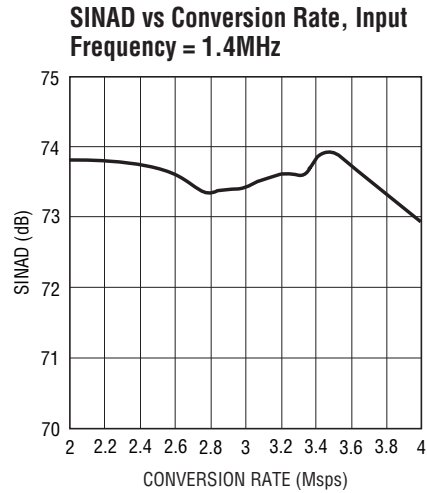

2355 G10

$T_A = 25^\circ\text{C}$ ,  $V_{DD} = 3.3\text{V}$  (LTC2355-12 and LTC2355-14)

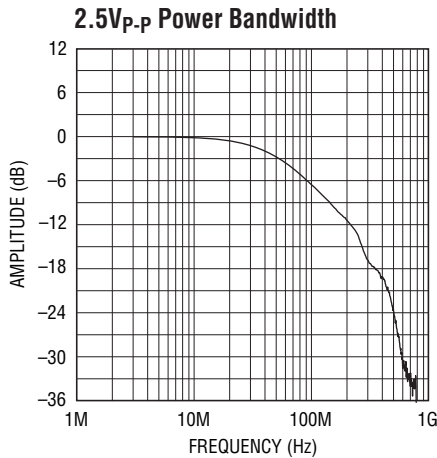

2355 G11

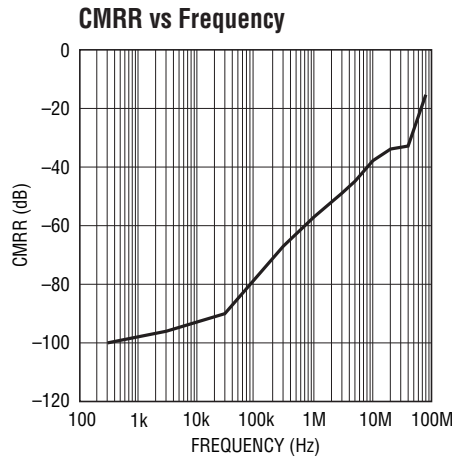

2355 G12

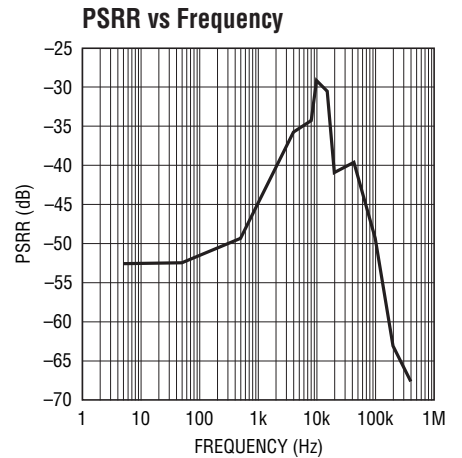

2355 G13

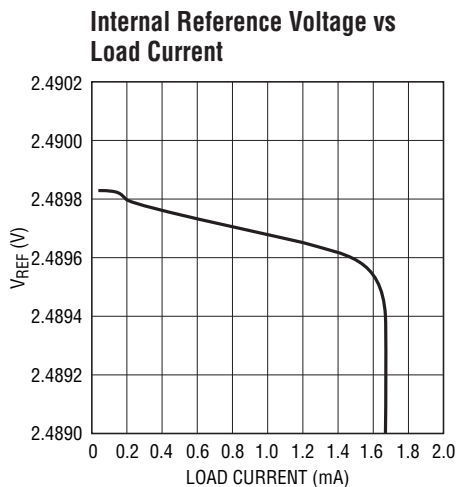

2355 G14

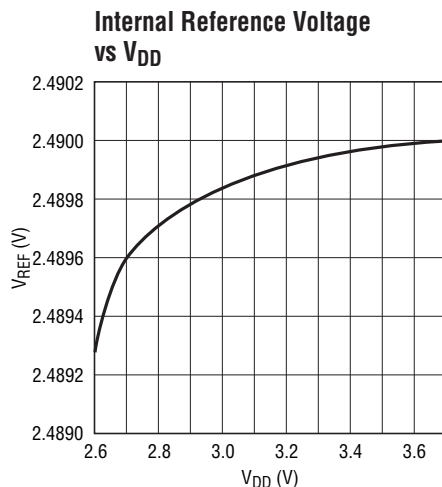

2355 G15

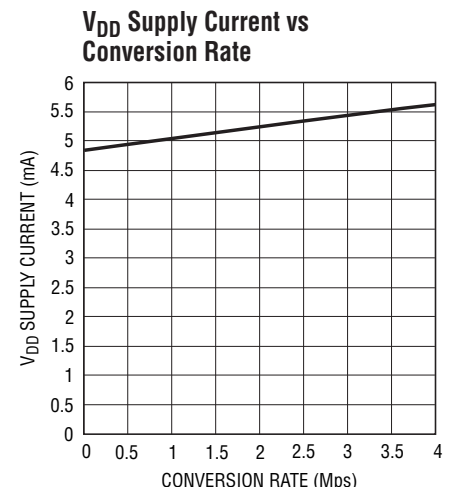

2355 G16

2355fa

## PIN FUNCTIONS

**$A_{IN}^+$  (Pin 1):** Noninverting Analog Input.  $A_{IN}^+$  operates fully differentially with respect to  $A_{IN}^-$  with a 0V to 2.5V differential swing and a 0V to  $V_{DD}$  common mode swing.

**$A_{IN}^-$  (Pin 2):** Inverting Analog Input.  $A_{IN}^-$  operates fully differentially with respect to  $A_{IN}^+$  with a -2.5V to 0V differential swing and a 0V to  $V_{DD}$  common mode swing.

**$V_{REF}$  (Pin 3):** 2.5V Internal Reference. Bypass to GND and to a solid analog ground plane with a 10 $\mu$ F ceramic capacitor (or 10 $\mu$ F tantalum in parallel with 0.1 $\mu$ F ceramic). Can be overdriven by an external reference between 2.55V and  $V_{DD}$ .

**GND (Pins 4, 5, 6, 11):** Ground and Exposed Pad. These ground pins and the exposed pad must be tied directly to the solid ground plane under the part. Keep in mind that analog signal currents and digital output signal currents flow through these pins.

**$V_{DD}$  (Pin 7):** 3.3V Positive Supply. This single power pin supplies 3.3V to the entire device. Bypass to GND and to a solid analog ground plane with a 10 $\mu$ F ceramic capacitor

(or 10 $\mu$ F tantalum in parallel with 0.1 $\mu$ F ceramic). Keep in mind that internal analog currents and digital output signal currents flow through this pin. Care should be taken to place the 0.1 $\mu$ F bypass capacitor as close to Pins 6 and 7 as possible.

**SDO (Pin 8):** Three-State Serial Data Output. Each set of output data words represents the difference between  $A_{IN}^+$  and  $A_{IN}^-$  analog inputs at the start of the previous conversion.

**SCK (Pin 9):** External Clock Input. Advances the conversion process and sequences the output data on the rising edge. Responds to TTL ( $\leq 3.3V$ ) and 3.3V CMOS levels. One or more SCK pulses wakes the ADC from sleep mode.

**CONV (Pin 10):** Convert Start. Holds the analog input signal and starts the conversion on the rising edge. Responds to TTL ( $\leq 3.3V$ ) and 3.3V CMOS levels. Two CONV pulses with SCK in fixed high or fixed low state start Nap mode. Four or more CONV pulses with SCK in fixed high or fixed low state start Sleep mode.

## BLOCK DIAGRAM

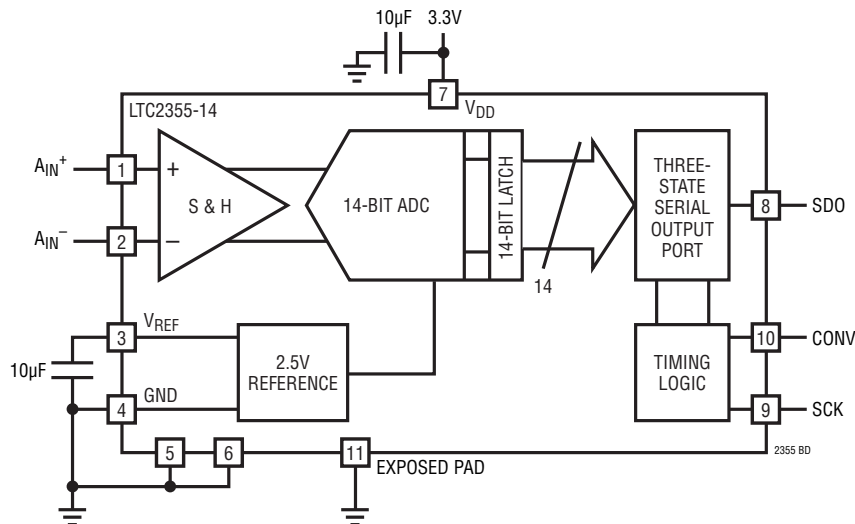



# TIMING DIAGRAM

LTC2355-12 Timing Diagram

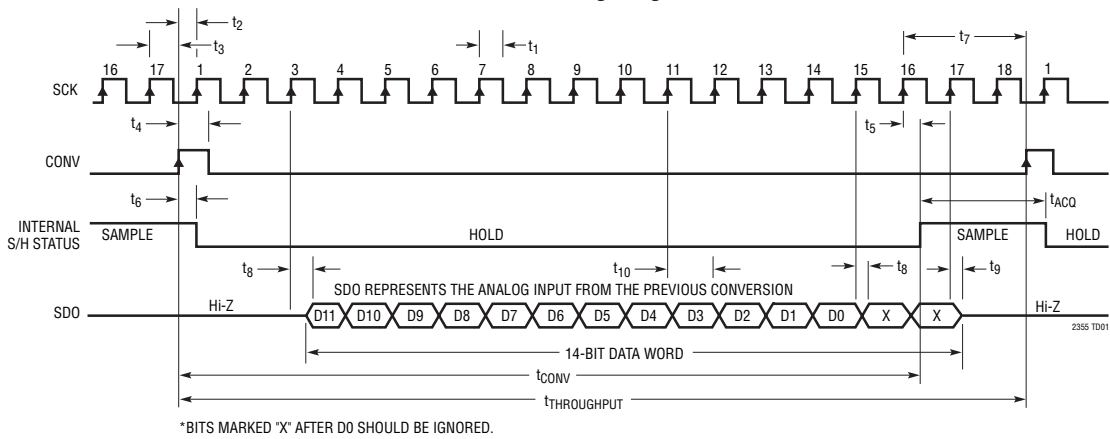

LTC2355-14 Timing Diagram

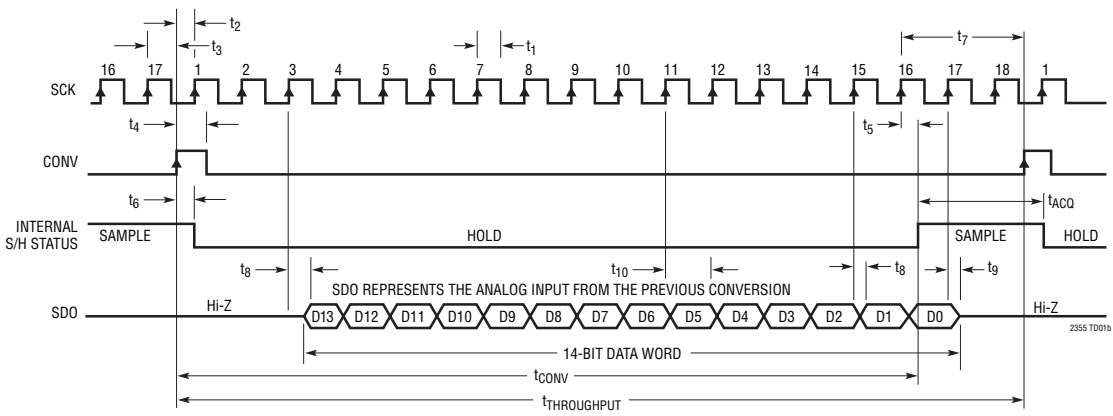

Nap Mode and Sleep Mode Waveforms

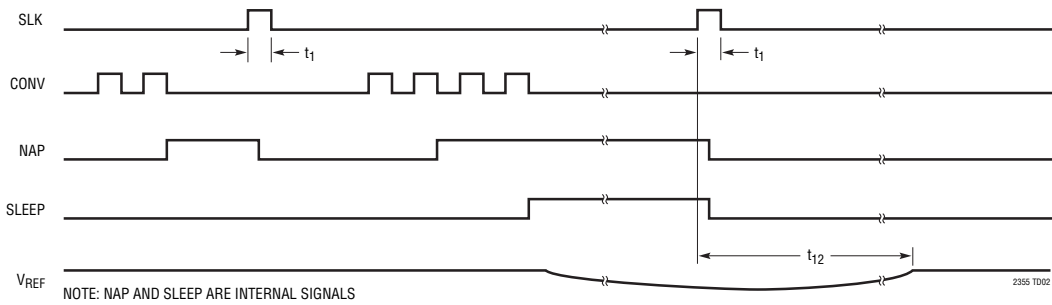

SCK to SDO Delay

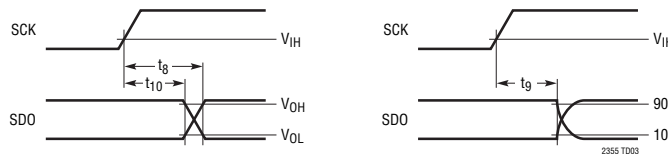

## APPLICATIONS INFORMATION

### DRIVING THE ANALOG INPUT

The differential analog inputs of the LTC2355-12/LTC2355-14 may be driven differentially or as a single-ended input (i.e., the  $A_{IN}^-$  input is grounded). Both differential analog inputs,  $A_{IN}^+$  and  $A_{IN}^-$ , are sampled at the same instant. Any unwanted signal that is common to both inputs of each input pair will be reduced by the common mode rejection of the sample-and-hold circuit. The inputs draw only one small current spike while charging the sample-and-hold capacitors at the end of conversion. During conversion, the analog inputs draw only a small leakage current. If the source impedance of the driving circuit is low, then the LTC2355-12/LTC2355-14 inputs can be driven directly. As source impedance increases, so will acquisition time. For minimum acquisition time with high source impedance, a buffer amplifier must be used. The main requirement is that the amplifier driving the analog input(s) must settle after the small current spike before the next conversion starts (settling time must be 39ns for full throughput rate). Also keep in mind while choosing an input amplifier the amount of noise and harmonic distortion added by the amplifier.

### CHOOSING AN INPUT AMPLIFIER

Choosing an input amplifier is easy if a few requirements are taken into consideration. First, to limit the magnitude of the voltage spike seen by the amplifier from charging the sampling capacitor, choose an amplifier that has a low output impedance ( $<100\Omega$ ) at the closed-loop bandwidth frequency. For example, if an amplifier is used in a gain of 1 and has a unity-gain bandwidth of 50MHz, then the output impedance at 50MHz must be less than  $100\Omega$ . The second requirement is that the closed-loop bandwidth must be greater than 40MHz to ensure adequate small-signal settling for full throughput rate. If slower op amps are used, more time for settling can be provided by increasing the time between conversions. The best choice for an op amp to drive the LTC2355-12/LTC2355-14 will depend on the application. Generally, applications fall into two categories: AC applications where dynamic specifications are most critical and time domain applications where DC accuracy and settling time are most critical. The following list is a summary of the op amps that are suitable for driving the LTC2355-12/LTC2355-14. (More

detailed information is available in the Linear Technology Databooks and on the LinearView™ CD-ROM.)

**LT1566-1:** Low Noise 2.3MHz Continuous Time Low-Pass Filter.

**LT<sup>®</sup>1630:** Dual 30MHz Rail-to-Rail Voltage FB Amplifier. 2.7V to  $\pm 15V$  supplies. Very high  $A_{VOL}$ , 500 $\mu V$  offset and 520ns settling to 0.5LSB for a 4V swing. THD and noise are  $-93dB$  to 40kHz and below 1LSB to 320kHz ( $A_V = 1$ ,  $2V_{P-P}$  into  $1k\Omega$ ,  $V_S = 5V$ ), making the part excellent for AC applications (to 1/3 Nyquist) where rail-to-rail performance is desired. Quad version is available as LT1631.

**LT1632:** Dual 45MHz Rail-to-Rail Voltage FB Amplifier. 2.7V to  $\pm 15V$  supplies. Very high  $A_{VOL}$ , 1.5mV offset and 400ns settling to 0.5LSB for a 4V swing. It is suitable for applications with a single 5V supply. THD and noise are  $-93dB$  to 40kHz and below 1LSB to 800kHz ( $A_V = 1$ ,  $2V_{P-P}$  into  $1k\Omega$ ,  $V_S = 5V$ ), making the part excellent for AC applications where rail-to-rail performance is desired. Quad version is available as LT1633.

**LT1813:** Dual 100MHz 750V/ $\mu s$  3mA Voltage Feedback Amplifier. 5V to  $\pm 5V$  supplies. Distortion is  $-86dB$  to 100kHz and  $-77dB$  to 1MHz with  $\pm 5V$  supplies ( $2V_{P-P}$  into  $500\Omega$ ). Excellent part for fast AC applications with  $\pm 5V$  supplies.

**LT1801:** 80MHz GBWP,  $-75dBc$  at 500kHz, 2mA/Amplifier, 8.5nV/ $\sqrt{Hz}$ .

**LT1806/LT1807:** 325MHz GBWP,  $-80dBc$  Distortion at 5MHz, Unity-Gain Stable, R-R In and Out, 10mA/Amplifier, 3.5nV/ $\sqrt{Hz}$ .

**LT1810:** 180MHz GBWP,  $-90dBc$  Distortion at 5MHz, Unity-Gain Stable, R-R In and Out, 15mA/Amplifier, 16nV/ $\sqrt{Hz}$ .

**LT1818/LT1819:** 400MHz, 2500V/ $\mu s$ , 9mA, Single/Dual Voltage Mode Operational Amplifier.

**LT6200:** 165MHz GBWP,  $-85dBc$  Distortion at 1MHz, Unity-Gain Stable, R-R In and Out, 15mA/Amplifier, 0.95nV/ $\sqrt{Hz}$ .

**LT6203:** 100MHz GBWP,  $-80dBc$  Distortion at 1MHz, Unity-Gain Stable, R-R In and Out, 3mA/Amplifier, 1.9nV/ $\sqrt{Hz}$ .

**LT6600-10:** Amplifier/Filter Differential In/Out with 10MHz Cutoff.

LinearView is a trademark of Linear Technology Corporation.

2355fa

## APPLICATIONS INFORMATION

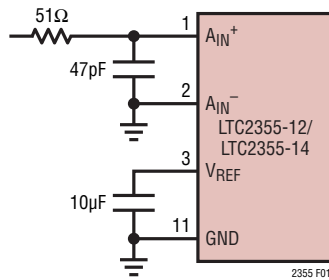

Figure 1. RC Input Filter

### INPUT FILTERING AND SOURCE IMPEDANCE

The noise and the distortion of the input amplifier and other circuitry must be considered since they will add to the LTC2355-12/LTC2355-14 noise and distortion. The small-signal bandwidth of the sample-and-hold circuit is 50MHz. Any noise or distortion products that are present at the analog inputs will be summed over this entire bandwidth. Noisy input circuitry should be filtered prior to the analog inputs to minimize noise. A simple 1-pole RC filter is sufficient for many applications. For example, Figure 1 shows a 47pF capacitor from  $A_{IN}^+$  to ground and a 51Ω source resistor to limit the input bandwidth to 47MHz. The 47pF capacitor also acts as a charge reservoir for the input sample-and-hold and isolates the ADC input from sampling-glitch sensitive circuitry. High quality capacitors and resistors should be used since these components can add distortion. NPO and silvermica type dielectric capacitors have excellent linearity. Carbon surface mount resistors can generate distortion from self heating and from damage that may occur during soldering. Metal film surface mount resistors are much less susceptible to both problems. When high amplitude unwanted signals are close in frequency to the desired signal frequency, a multiple pole filter is required. High external source resistance, combined with the 13pF of input capacitance, will reduce the rated 50MHz bandwidth and increase acquisition time beyond 39ns.

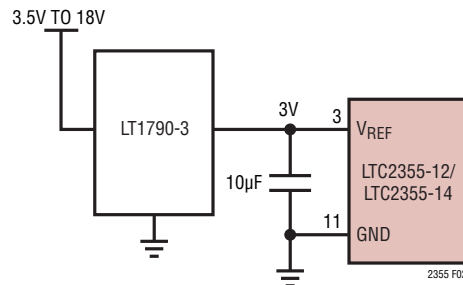

Figure 2. Overdriving  $V_{REF}$  Pin with an External Reference

### INPUT RANGE

The analog inputs of the LTC2355-12/LTC2355-14 may be driven fully differentially with a single supply. Each input may swing up to  $2.5V_{P-P}$  individually. When using the internal reference, the noninverting input should never be more than 2.5V more positive than the inverting input. The 0V to 2.5V range is also ideally suited for single-ended input use with single supply applications. The common mode range of the inputs extend from ground to the supply voltage  $V_{DD}$ . If the difference between the  $A_{IN}^+$  and  $A_{IN}^-$  inputs exceeds 2.5V, the output code will stay fixed at all ones and if this difference goes below 0V, the output code will stay fixed at all zeros.

### INTERNAL REFERENCE

The LTC2355-12/LTC2355-14 has an on-chip, temperature compensated, bandgap reference that is factory trimmed to 2.5V to obtain a unipolar 0V to 2.5V input span. The reference amplifier output  $V_{REF}$  (Pin 3) must be bypassed with a capacitor to ground. The reference amplifier is stable with capacitors of 1μF or greater. For the best noise performance, a 10μF ceramic or a 10μF tantalum in parallel with a 0.1μF ceramic is recommended. The  $V_{REF}$  pin can be overdriven with an external reference as shown in Figure 2. The voltage of the external reference must be higher than the 2.5V output of the internal reference. The recommended range for an external reference is 2.55V to  $V_{DD}$ . An external reference at 2.55V will see a DC quiescent load of 0.75mA and as much as 3mA during conversion.

## APPLICATIONS INFORMATION

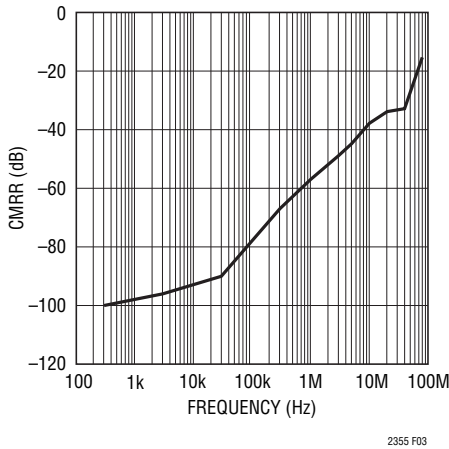

Figure 3. CMRR vs Frequency

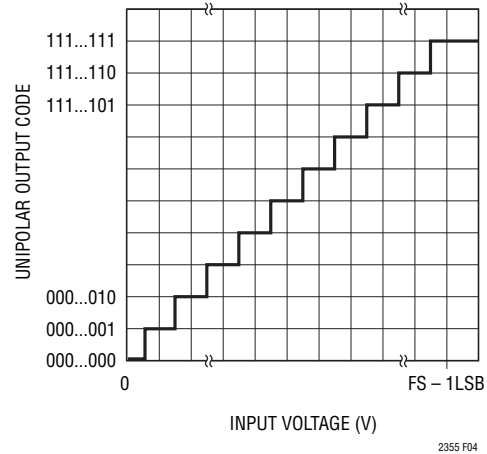

Figure 4. LTC2355-12/LTC2355-14 Transfer Characteristic

### INPUT SPAN VERSUS REFERENCE VOLTAGE

The differential input range has a 0V to  $V_{REF}$  unipolar voltage span that equals the difference between the voltage at the reference buffer output  $V_{REF}$  at Pin 3, and the voltage at the ground (Exposed Pad Ground). The differential input range of the ADC is 0V to 2.5V when using the internal reference. The internal ADC is referenced to these two nodes. This relationship also holds true with an external reference.

### DIFFERENTIAL INPUTS

The LTC2355-12/LTC2355-14 has a unique differential sample-and-hold circuit that measures input voltages from ground to  $V_{DD}$ . The ADC will always convert the unipolar difference of  $A_{IN}^+ - A_{IN}^-$ , independent of the common

mode voltage at the inputs. The common mode rejection holds up at extremely high frequencies, see Figure 3. The only requirement is that both inputs not go below ground or exceed  $V_{DD}$ . Integral nonlinearity errors (INL) and differential nonlinearity errors (DNL) are largely independent of the common mode voltage. However, the offset error will vary. The change in offset error is typically less than 0.1% of the common mode voltage.

Figure 4 shows the ideal input/output characteristics for the LTC2355-12/LTC2355-14. The code transitions occur midway between successive integer LSB values (i.e., 0.5LSB, 1.5LSB, 2.5LSB,  $FS - 1.5LSB$ ). The output code is straight binary with  $1LSB = 2.5V/16384 = 153\mu V$  for the LTC2355-14, and  $1LSB = 2.5V/4096 = 610\mu V$  for the LTC2355-12. The LTC2355-14 has 1LSB RMS of random white noise.

## APPLICATIONS INFORMATION

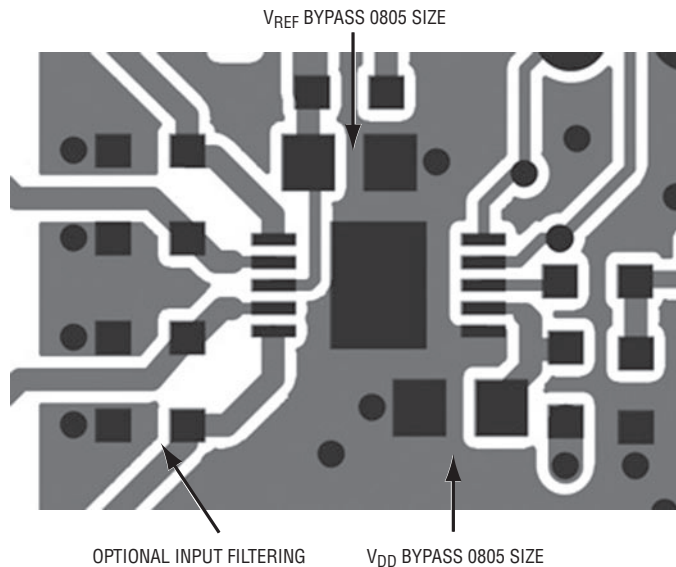

Figure 5. Recommended Layout

### Board Layout and Bypassing

Wire wrap boards are not recommended for high resolution and/or high speed A/D converters. To obtain the best performance from the LTC2355-12/LTC2355-14, a printed circuit board with ground plane is required. Layout for the printed circuit board should ensure that digital and analog signal lines are separated as much as possible. In particular, care should be taken not to run any digital track alongside an analog signal track. If optimum phase match between the inputs is desired, the length of the two input wires should be kept matched.

High quality tantalum and ceramic bypass capacitors should be used at the  $V_{DD}$  and  $V_{REF}$  pins as shown in the Block Diagram on the first page of this data sheet. For optimum performance, a  $10\mu\text{F}$  surface mount Tantalum capacitor with a  $0.1\mu\text{F}$  ceramic is recommended for the  $V_{DD}$  and  $V_{REF}$  pins. Alternatively,  $10\mu\text{F}$  ceramic chip capaci-

tors such as Murata GRM235Y5V106Z016 may be used. The capacitors must be located as close to the pins as possible. The traces connecting the pins and the bypass capacitors must be kept short and should be made as wide as possible.

Figure 5 shows the recommended system ground connections. All analog circuitry grounds should be terminated at the LTC2355-12/LTC2355-14 GND (Pins 4, 5, 6 and exposed pad). The ground return from the LTC2355-12/LTC2355-14 (Pins 4, 5, 6 and exposed pad) to the power supply should be low impedance for noise free operation. In applications where the ADC data outputs and control signals are connected to a continuously active microprocessor bus, it is possible to get errors in the conversion results. These errors are due to feedthrough from the microprocessor to the successive approximation comparator. The problem can be eliminated by forcing the microprocessor into a Wait state during conversion or by using three-state buffers to isolate the ADC data bus.

### POWER-DOWN MODES

Upon power-up, the LTC2355-12/LTC2355-14 is initialized to the active state and is ready for conversion. The Nap and Sleep mode waveforms show the power-down modes for the LTC2355-12/LTC2355-14. The SCK and CONV inputs control the power-down modes (see Timing Diagrams). Two rising edges at CONV, without any intervening rising edges at SCK, put the LTC2355-12/LTC2355-14 in Nap mode and the power consumption drops from  $18\text{mW}$  to  $4\text{mW}$ . The internal reference remains powered in Nap mode. One or more rising edges at SCK wake up the LTC2355-12/LTC2355-14 very quickly, and CONV can start an accurate conversion within a clock cycle. Four rising edges at CONV, without any intervening rising edges at SCK, put the LTC2355-12/LTC2355-14



## APPLICATIONS INFORMATION

in Sleep mode and the power consumption drops from 18mW to 13 $\mu$ W. One or more rising edges at SCK wake up the LTC2355-12/LTC2355-14 for operation. The internal reference ( $V_{REF}$ ) takes 2ms to slew and settle with a 10 $\mu$ F load. Note that, using sleep mode more frequently than every 2ms, compromises the settled accuracy of the internal reference. Note that, for slower conversion rates, the Nap and Sleep modes can be used for substantial reductions in power consumption.

### DIGITAL INTERFACE

The LTC2355-12/LTC2355-14 has a 3-wire SPI-compatible (Serial Protocol Interface) interface. The SCK and CONV inputs and SDO output implement this interface. The SCK and CONV inputs accept swings from 3.3V logic and are TTL compatible, if the logic swing does not exceed  $V_{DD}$ . A detailed description of the three serial port signals follows.

### Conversion Start Input (CONV)

The rising edge of CONV starts a conversion, but subsequent rising edges at CONV are ignored by the LTC2355-12/LTC2355-14 until the following 16 SCK rising edges have occurred. It is necessary to have a minimum of 16 rising edges of the clock input SCK between rising edges of CONV. But to obtain maximum conversion speed (with a 63MHz SCK), it is necessary to allow two more clock periods between conversions to allow 39ns of acquisition time for the internal ADC sample-and-hold circuit. With 16 clock periods per conversion, the maximum conversion rate is limited to 3.5Msps to allow 39ns for acquisition time. In either case, the output data stream comes out within the first 16 clock periods to ensure compatibility with processor serial ports. The duty cycle of CONV can be arbitrarily chosen to be used as a frame sync signal for the processor serial port. A simple approach to generate

CONV is to create a pulse that is one SCK wide to drive the LTC2355-12/LTC2355-14 and then buffer this signal with the appropriate number of inverters to ensure the correct delay driving the frame sync input of the processor serial port. It is good practice to drive the LTC2355-12/LTC2355-14 CONV input first to avoid digital noise interference during the sample-to-hold transition triggered by CONV at the start of conversion. It is also good practice to keep the width of the low portion of the CONV signal greater than 15ns to avoid introducing glitches in the front end of the ADC just before the sample-and-hold goes into hold mode at the rising edge of CONV.

### Minimizing Jitter on the CONV Input

In high speed applications where high amplitude sine waves above 100kHz are sampled, the CONV signal must have as little jitter as possible (10ps or less). The square wave output of a common crystal clock module usually meets this requirement. The challenge is to generate a CONV signal from this crystal clock without jitter corruption from other digital circuits in the system. A clock divider and any gates in the signal path from the crystal clock to the CONV input should not share the same integrated circuit with other parts of the system. As shown in Figure 6, the SCK and CONV inputs should be driven first, with digital buffers used to drive the serial port interface. Also note that the master clock in the DSP may already be corrupted with jitter, even if it comes directly from the DSP crystal. Another problem with high speed processor clocks is that they often use a low cost, low speed crystal (i.e., 10MHz) to generate a fast, but jittery, phase-locked-loop system clock (i.e., 40MHz). The jitter in these PLL-generated high speed clocks can be several nanoseconds. Note that if you choose to use the frame sync signal generated by the DSP port, this signal will have the same jitter of the DSP's master clock.

## APPLICATIONS INFORMATION

The Typical Application Figure on page 16 shows a circuit for level-shifting and squaring the output from an RF signal generator or other low-jitter source. A single D-type flip flop is used to generate the CONV signal to the LTC2355-12/LTC2355-14. Re-timing the master clock signal eliminates clock jitter introduced by the controlling device (DSP, FPGA, etc.) Both the inverter and flip flop must be treated as analog components and should be powered from a clean analog supply.

### Serial Clock Input (SCK)

The rising edge of SCK advances the conversion process and also updates each bit in the SDO data stream. After CONV rises, the third rising edge of SCK starts clocking out the 12/14 data bits with the MSB sent first. A simple approach is to generate SCK to drive the LTC2355-12/LTC2355-14 first and then buffer this signal with the appropriate number of inverters to drive the serial clock input of the processor serial port. Use the falling edge of the clock to latch data from the Serial Data Output (SDO) into your processor serial port. The 14-bit serial data will be received right justified, in a 16-bit word with 16 or more clocks per frame sync. It is good practice to drive the LTC2355-12/LTC2355-14 SCK input first to avoid digital noise interference during the internal bit comparison

decision by the internal high speed comparator. Unlike the CONV input, the SCK input is not sensitive to jitter because the input signal is already sampled and held constant.

### Serial Data Output (SDO)

Upon power-up, the SDO output is automatically reset to the high impedance state. The SDO output remains in high impedance until a new conversion is started. SDO sends out 12/14 bits in the output data stream beginning at the third rising edge of SCK after the rising edge of CONV. SDO is always in high impedance mode when it is not sending out data bits. Please note the delay specification from SCK to a valid SDO. SDO is always guaranteed to be valid by the next rising edge of SCK. The 16-bit output data stream is compatible with the 16-bit or 32-bit serial port of most processors.

Loading on the SDO line must be minimized. SDO can directly drive most fast CMOS logic inputs directly. However, the general purpose I/O pins on many programmable logic devices (FPGAs, CPLDs) and DSPs have excessive capacitance. In these cases, a 100Ω resistor in series with SDO can isolate the input capacitance of the receiving device. If the receiving device has more than 10pF of input capacitance or is located far from the LTC2355-12/LTC2355-14, an NC7SVU04P5X inverter can be used to provide more drive.

## PACKAGE DESCRIPTION

### MSE Package 10-Lead Plastic MSOP, Exposed Die Pad (Reference LTC DWG # 05-08-1664 Rev C)

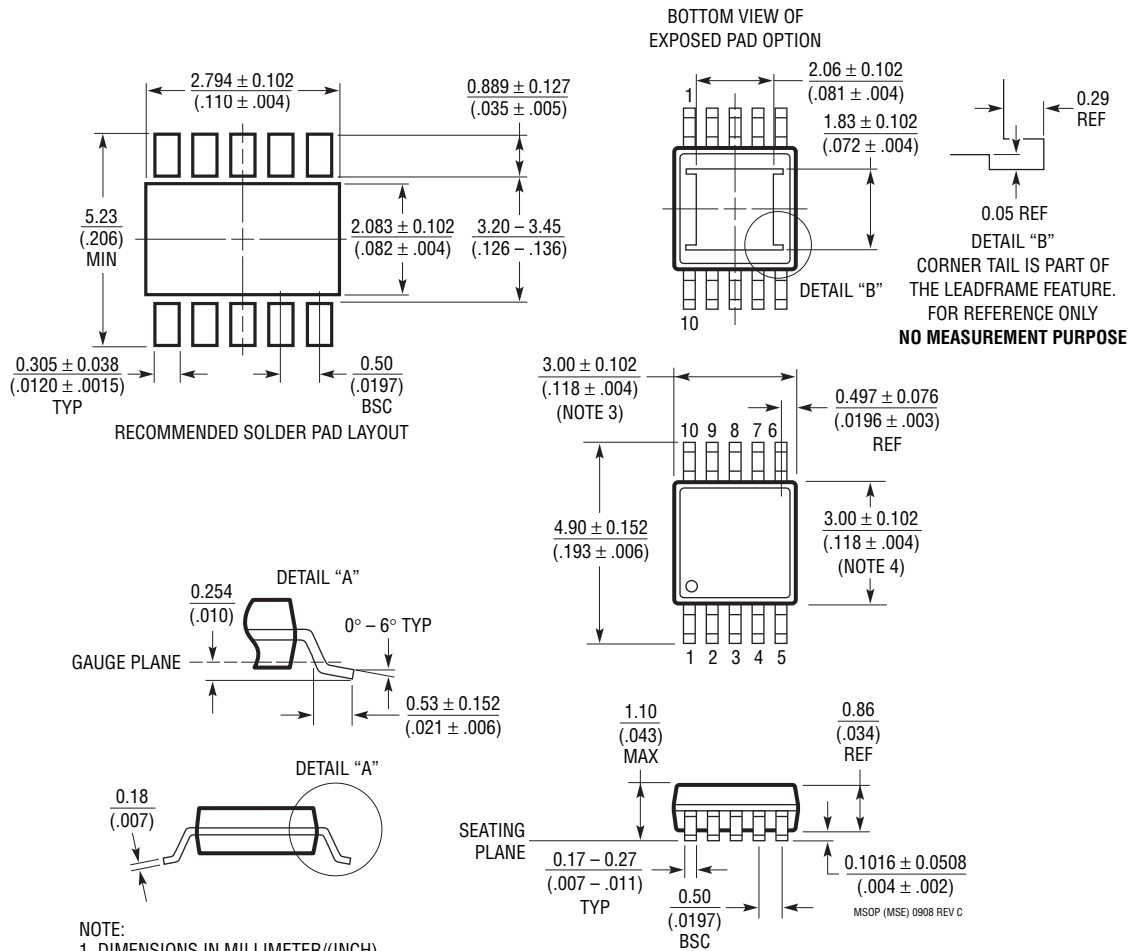



## REVISION HISTORY

REV	DATE	DESCRIPTION	PAGE NUMBER
A	01/10	Revise Values in Pin Configuration Section	2

# LTC2355-12/LTC2355-14

## TYPICAL APPLICATION

### Low-Jitter Clock Timing with RF Sine Generator Using Clock Squaring/Level Shifting Circuit and Re-Timing Flip-Flop

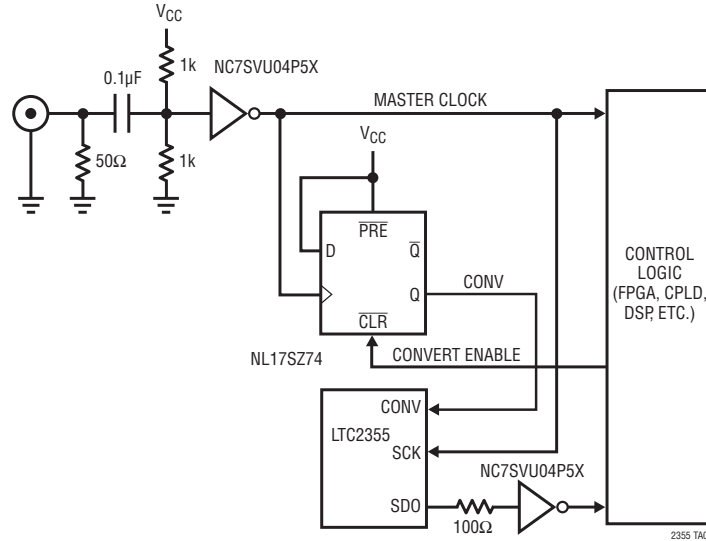

## RELATED PARTS

PART NUMBER	DESCRIPTION	COMMENTS
<b>ADCs</b>		
LTC1402	12-Bit, 2.2Msps Serial ADC	5V or ±5V Supply, 4.096V or ±2.5V Span
LTC1403/LTC1403A	12-/14-Bit, 2.8Msps Serial ADC	3V, 15mW, Unipolar Inputs, MSOP Package
LTC1403-1/LTC1403A-1	12-/14-Bit, 2.8Msps Serial ADC	3V, 15mW, Bipolar Inputs, MSOP Package
LTC1405	12-Bit, 5Msps Parallel ADC	5V, Selectable Spans, 115mW
LTC1407/LTC1407A	12-/14-Bit, 3Msps Simultaneous Sampling ADC	3V, 2-Channel Differential, Unipolar Inputs, 14mW, MSOP Package
LTC1407-1/LTC1407A-1	12-/14-Bit, 3Msps Simultaneous Sampling ADC	3V, 2-Channel Differential, Bipolar Inputs, 14mW, MSOP Package
LTC1411	14-Bit, 2.5Msps Parallel ADC	5V, Selectable Spans, 80dB SINAD
LTC1412	12-Bit, 3Msps Parallel ADC	±5V Supply, ±2.5V Span, 72dB SINAD
LCT1414	14-Bit, 2.2Msps Parallel ADC	±5V Supply, ±2.5V Span, 78dB SINAD
LTC1420	12-Bit, 10Msps Parallel ADC	5V, Selectable Spans, 72dB SINAD
LTC1604	16-Bit, 333ksps Parallel ADC	±5V Supply, ±2.5V Span, 90dB SINAD
LTC1608	16-Bit, 500ksps Parallel ADC	±5V Supply, ±2.5V Span, 90dB SINAD
LTC1609	16-Bit, 250ksps Serial ADC	5V, Configurable Bipolar/Unipolar Inputs
LTC1864/LTC1865	16-Bit, 250ksps Serial ADCs	5V Supply, 1 and 2 Channel, 4.3mW, MSOP Package
LTC2356-12/LTC2356-14	12-/14-Bit, 3.5Msps Serial ADC	3.3V Supply, ±1.25V Span, MSOP Package
<b>DACs</b>		
LTC1666/LTC1667/LTC1668	12-/14-/16-Bit, 50Msps DACs	87dB SFDR, 20ns Settling Time
LTC1592	16-Bit, Serial SoftSpan™ I <sub>OUT</sub> DAC	±1LSB INL/DNL, Software Selectable Spans
<b>References</b>		
LT1790-2.5	Micropower Series Reference in SOT-23	0.05% Initial Accuracy, 10ppm Drift
LT1461-2.5	Precision Voltage Reference	0.04% Initial Accuracy, 3ppm Drift
LT1460-2.5	Micropower Series Voltage Reference	0.1% Initial Accuracy, 10ppm Drift

SoftSpan is a trademark of Linear Technology Corporation.

2355fa