

Dual Zero-Drift Operational Amplifier

February 2000

FEATURES

- Maximum Offset Voltage of 3 μ V
- Maximum Offset Voltage Drift of 30nV/ $^{\circ}$ C
- Small Footprint, Low Profile MS8 Package
- Noise: 1.5 μ V_{P-P} (0.1Hz to 10Hz Typ)
- Voltage Gain: 140dB (Typ)
- PSRR: 130dB (Typ)
- CMRR: 130dB (Typ)
- Supply Current: 0.75mA (Typ) per Amplifier
- Single Supply Operation: 2.7V to 11V
- Extended Common Mode Input Range
- Output Swings Rail-to-Rail
- Overload Recovery Time: 2ms (Typ)
- Operating Temperature Range -40 $^{\circ}$ C to 85 $^{\circ}$ C

APPLICATIONS

- Thermocouple Amplifiers
- Electronic Scales
- Medical Instrumentation
- Strain Gauge Amplifiers
- High Resolution Data Acquisition
- DC Accurate RC Active Filters

DESCRIPTION

The LTC[®]2051 is a dual zero-drift operational amplifier available in the MS8 and SO-8 packages. It operates from a single 2.7V supply while still supporting \pm 5V applications. The power consumption is 750 μ A per op amp.

The LTC2051, despite its miniature size, features uncompromising DC performance. The typical input offset voltage and offset drift are 0.5 μ V and 10nV/ $^{\circ}$ C. The almost zero DC offset and drift are supported with a power supply rejection ratio (PSRR) and common mode rejection ratio (CMRR) of more than 130dB.

The input common mode voltage ranges from the negative supply up to 1V from the positive supply. The LTC2051 also has an enhanced output stage capable of driving loads as low as 1k Ω to both supply rails. The open-loop gain, loaded with 1k Ω , is in excess of 140dB. The LTC2051 also features a 1.5 μ V_{P-P} DC to 10Hz noise and a 3MHz gain bandwidth product.

 LTC and LT are registered trademarks of Linear Technology Corporation.

TYPICAL APPLICATION

High Performance Low Cost Instrumentation Amplifier

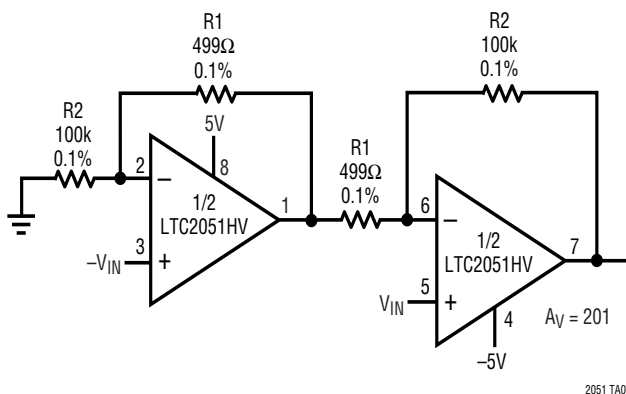

Input Referred Noise 0.1Hz to 10Hz

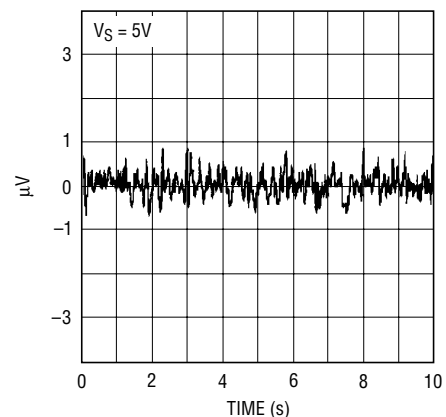

LTC2051

ABSOLUTE MAXIMUM RATINGS (Note 1)

Total Supply Voltage (V^+ to V^-)	Operating Temperature Range	-40°C to 85°C
LTC2051	Specified Temperature Range (Note 3) ..	-40°C to 85°C
LTC2051HV	Storage Temperature Range	-65°C to 150°C
Input Voltage	Lead Temperature (Soldering, 10 sec)	300°C
Output Short-Circuit Duration		Indefinite

PACKAGE/ORDER INFORMATION

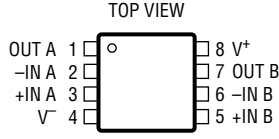
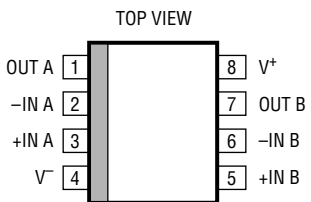
 <p>MS8 PACKAGE 8-LEAD PLASTIC MSOP $T_{JMAX} = 125^{\circ}\text{C}$, $\theta_{JA} = 250^{\circ}\text{C/W}$</p>	ORDER PART NUMBER	 <p>S8 PACKAGE 8-LEAD PLASTIC SO $T_{JMAX} = 125^{\circ}\text{C}$, $\theta_{JA} = 190^{\circ}\text{C/W}$</p>	ORDER PART NUMBER
	LTC2051CMS8 LTC2051IMS8 LTC2051HVCMS8 LTC2051HVIMS8		LTC2051CS8 LTC2051IS8 LTC2051HVCS8 LTC2051HVIS8
	MS8 PART MARKING		S8 PART MARKING
	LTMN LTMP LTPJ LTPK		2051 2051I 2051HV 051HVI

Consult factory for Military grade parts.

ELECTRICAL CHARACTERISTICS: (LTC2051, LTC2051HV) The ● denotes the specifications which apply over the full operating temperature range, otherwise specifications are at $T_A = 25^{\circ}\text{C}$. $V_S = 3\text{V}$, 5V unless otherwise noted. (Note 3)

PARAMETER	CONDITIONS	MIN	TYP	MAX	UNITS
Input Offset Voltage	(Note 2)		± 0.5	± 3	μV
Average Input Offset Drift	(Note 2)	●		± 0.03	$\mu\text{V}/^{\circ}\text{C}$
Long-Term Offset Drift			50		$\text{nV}/\sqrt{\text{mo}}$
Input Bias Current	$V_S = 3\text{V}$		± 8	± 50	pA
	$V_S = 3\text{V}$	●		± 100	pA
Input Offset Current	$V_S = 5\text{V}$		± 25	± 75	pA
	$V_S = 5\text{V}$	●		± 150	pA
Input Offset Current	$V_S = 3\text{V}$			± 100	pA
	$V_S = 3\text{V}$	●		± 150	pA
Input Offset Current	$V_S = 5\text{V}$			± 150	pA
	$V_S = 5\text{V}$	●		± 200	pA
Input Noise Voltage	$R_S = 100\Omega$, DC to 10Hz		1.5		$\mu\text{V}_{\text{P-P}}$
Common Mode Rejection Ratio	$V_{\text{CM}} = V^-$ to $V^+ - 1.3$, $V_S = 3\text{V}$	●	115	130	dB
	$V_{\text{CM}} = V^-$ to $V^+ - 1.3$, $V_S = 3\text{V}$	●	110	130	dB
Common Mode Rejection Ratio	$V_{\text{CM}} = V^-$ to $V^+ - 1.3$, $V_S = 5\text{V}$	●	120	130	dB
	$V_{\text{CM}} = V^-$ to $V^+ - 1.3$, $V_S = 5\text{V}$	●	115	130	dB
Power Supply Rejection Ratio		●	120	130	dB
		●	115	130	dB

ELECTRICAL CHARACTERISTICS

The ● denotes the specifications which apply over the full operating temperature range, otherwise specifications are at $T_A = 25^\circ\text{C}$. $V_S = 3\text{V}$, 5V unless otherwise noted. (Note 3)

PARAMETER	CONDITIONS		MIN	TYP	MAX	UNITS
Large-Signal Voltage Gain	$R_L = 10\text{k}$, $V_S = 3\text{V}$	●	120	140		dB
			115	140		dB
	$R_L = 10\text{k}$, $V_S = 5\text{V}$	●	125	140		dB
			120	140		dB
Maximum Output Voltage Swing	$R_L = 2\text{k}$	●	$V^+ - 0.15$	$V^+ - 0.06$		V
	$R_L = 10\text{k}$	●	$V^+ - 0.05$	$V^+ - 0.02$		V
Slew Rate				2		V/ μs
Gain Bandwidth Product				3		MHz
Supply Current (2 Amplifiers)	No Load, $V_S = 3\text{V}$	●		1.5	2.0	mA
	No Load, $V_S = 5\text{V}$	●		1.7	2.4	mA
Internal Sampling Frequency				7.5		kHz

The ● denotes the specifications which apply over the full operating temperature range, otherwise specifications are at $T_A = 25^\circ\text{C}$. $V_S = \pm 5\text{V}$ unless otherwise noted. (Note 3) (LTC2051HV)

PARAMETER	CONDITIONS		MIN	TYP	MAX	UNITS
Input Offset Voltage	(Note 2)			± 1	± 3	μV
Average Input Offset Drift	(Note 2)	●			± 0.03	$\mu\text{V}/^\circ\text{C}$
Long-Term Offset Drift				50		$\text{nV}/\sqrt{\text{mo}}$
Input Bias Current		●		± 90	± 150	μA
					± 300	μA
Input Offset Current		●			± 300	μA
					± 500	μA
Input Noise Voltage	$R_S = 100\Omega$, DC to 10Hz			1.5		$\mu\text{V}_{\text{P-P}}$
Common Mode Rejection Ratio	$V_{\text{CM}} = V^-$ to $V^+ - 1.3$		125	130		dB
		●	120	130		dB
Power Supply Rejection Ratio			120	130		dB
		●	115	130		dB
Large-Signal Voltage Gain	$R_L = 10\text{k}$		125	140		dB
		●	120	140		dB
Maximum Output Voltage Swing	$R_L = 2\text{k}$	●	4.80	4.92		V
	$R_L = 10\text{k}$	●	4.95	4.98		V
Slew Rate				2		V/ μs
Gain Bandwidth Product				3		MHz
Supply Current (2 Amplifiers)	No Load	●		2	3	mA
Internal Sampling Frequency				7.5		kHz

Note 1: Absolute Maximum Ratings are those values beyond which the life of the device may be impaired.

Note 2: These parameters are guaranteed by design. Thermocouple effects preclude measurements of these voltage levels during automated testing.

Note 3: The LTC2051C, LTC2051HVC is guaranteed to meet specified performance from 0°C to 70°C and is designed, characterized and expected to meet these extended temperature limits, but is not tested at -40°C and 85°C . The LTC2051I, LTC2051HVI is guaranteed to meet the extended temperature limits.

PACKAGE DESCRIPTION Dimensions in inches (millimeters) unless otherwise noted.

MS8 Package 8-Lead Plastic MSOP (LTC DWG # 05-08-1660)

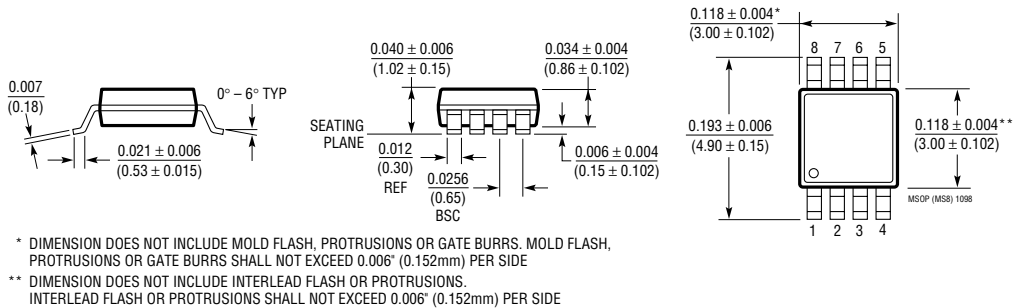

S8 Package 8-Lead Plastic Small Outline (Narrow 0.150) (LTC DWG # 05-08-1610)

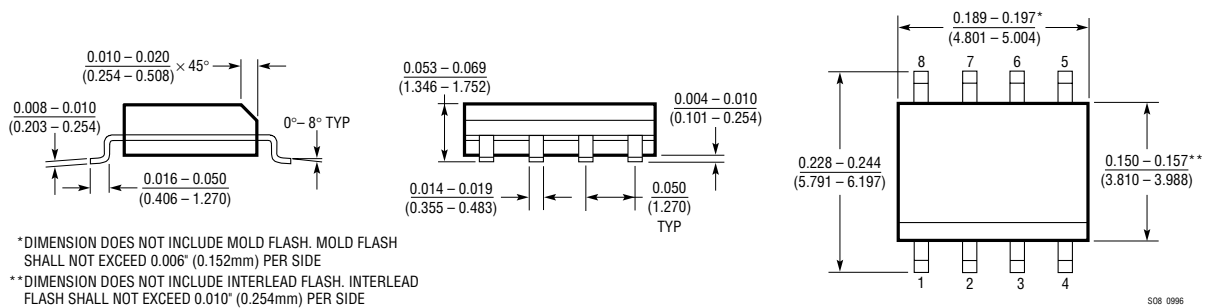

RELATED PARTS

PART NUMBER	DESCRIPTION	COMMENTS
LTC1051/LTC1053	Precision Zero-Drift Op Amp	Dual/Quad
LTC1151	$\pm 15V$ Zero-Drift Op Amp	Dual High Voltage Operation $\pm 18V$
LTC1152	Rail-to-Rail Input and Output Zero-Drift Op Amp	Single Zero-Drift Op Amp with Rail-to-Rail Input and Output and Shutdown
LTC2050	Zero-Drift Op Amp in SOT-23	Single Supply Operation 2.7V to 6V, Shutdown