

Distinctive Characteristics

International certifications from UL, CSA, VDE, SEMKO, and SEV.

High torque bushing construction prevents rotation or separation from frame during installation.

Stainless steel frame resists corrosion and increases environmental safety.

Case/base of heat resistant resin meets UL94V-0 flammability standard.

Contacts of special silver alloy resist arcing and guarantee stable electrical contact and long life.

High insulating barriers increase isolation of circuits in double pole devices and provide added protection to contact points.

Prominent external insulating barriers increase insulation resistance and dielectric strength.

Epoxy sealed terminals prevent entry of flux, solvents, and other contaminants.

Clinching of the frame to the case well above the base and terminals provides 4,000V dielectric strength.

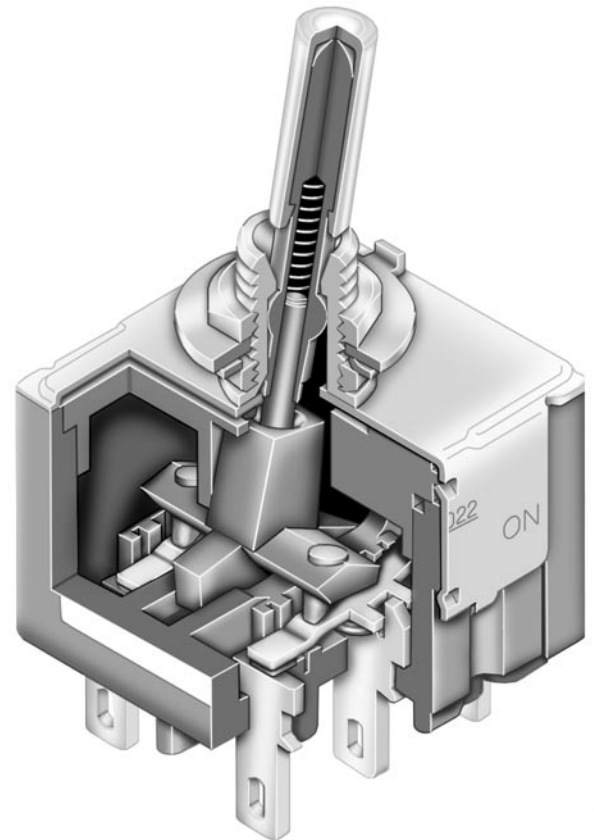

Actual Size

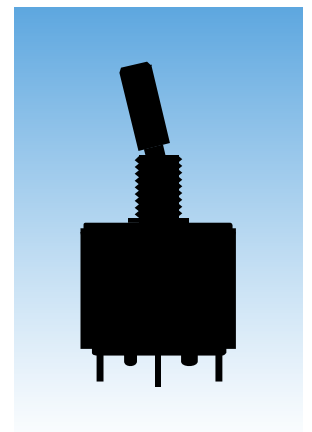

General Specifications

Electrical Capacity

Resistive Load:	10A @ 125V AC or 6A @ 250V AC
Motor Load:	400W @ 125V AC
Lamp Load:	2A @ 125V AC for On-Off-On circuit & 3A @ 125V AC for other circuits

Other Ratings

Contact Resistance:	10 milliohms maximum
Insulation Resistance:	1,000 megohms minimum @ 500V DC
Dielectric Strength:	2,000V AC minimum between contacts for 1 minute minimum; 4,000V AC minimum between contacts & case for 1 minute minimum
Mechanical Life:	100,000 operations minimum
Electrical Life:	25,000 operations minimum
Angle of Throw:	25°

Materials & Finishes

Toggle Cap:	Brass with nickel plating
Lever:	Brass with chrome plating
Bushing:	Brass with nickel plating
Frame:	Stainless steel
Case/Base:	Diallyl phthalate resin (UL94V-0)
Movable Contacts:	Silver alloy with silver plating
Stationary Contacts:	Pure silver with silver plating
Terminals:	Copper with silver plating







Environmental Data

Operating Temp Range:	-10°C through +85°C (+14°F through +185°F)
Humidity:	90 ~ 95% humidity for 96 hours @ 40°C (104°F)
Vibration:	10 ~ 55Hz with peak-to-peak amplitude of 1.5mm traversing the frequency range & returning in 1 minute; 3 right angled directions for 2 hours
Shock:	50G (490m/s ²) acceleration (tested in 6 right angled directions, with 5 shocks in each direction)

Installation

Soldering Time & Temp:	Wave Soldering Recommended (Straight PC): See Profile A in Supplement section. Manual Soldering: See Profile A in Supplement section.
-----------------------------------	--

Standards & Certifications

Flammability Standards:	UL94V-0 rated case/base
 UL Recognized:	All models recognized at 10A @ 125V AC & 6A @ 250V AC; UL File No. WOYR2.E44145. Add "/U" to end of part number to order UL mark on switch.
 C-UL Recognized:	All models recognized at 10A @ 125V AC & 6A @ 250V AC; C-UL File No. WOYR8.E44145. Add "/C-UL" to end of part number to order C-UL mark on switch.
 CSA Certified:	All models certified at 10A @ 125V AC & 6A @ 250V AC; CSA File No. 023535-0-000. Add "/C" to end of part number to order CSA mark on switch.
 VDE Approved:	All models approved at 10A @ 125V AC & 6A @ 250V AC; License No. 119174. Marking on switch is standard.
 SEMKO Approved:	P2011, P2012, P2013, P2021, P2022 models approved at 10A @ 125V AC & 6A @ 125/250V AC; Reference No. 9915205/01-02. Marking on switch is standard.
 SEV Approved:	All models with Quick Connect Terminals approved at 10A @ 125V AC & 6A @ 125/250V AC; (P2013 for micro-switch only); Authorization No. 02.0466. Marking on switch is standard.

TYPICAL SWITCH ORDERING EXAMPLE

P20	22	B							
POLES & CIRCUITS					TOGGLES & BUSHINGS			TERMINALS	
11	SPST	ON	NONE	OFF	No Code	.512" (13.0mm) White Cap with 6mm Bushing		No Code	Solder Lug
12	SPDT	ON	NONE	ON	E	.450" (11.4mm) Flatted with 6mm Bushing		P	Straight PC
13	SPDT	ON	OFF	ON	B	.689" (17.5mm) Large Bat with 12mm Bushing		Z	.187" (4.75mm) Quick Connect
21	DPST	ON	NONE	OFF	D	.748" (19.0mm) White Capped Column with 12mm Bushing			
22	DPDT	ON	NONE	ON					
23	DPDT	ON	OFF	ON					

DESCRIPTION FOR TYPICAL ORDERING EXAMPLE

P2022B

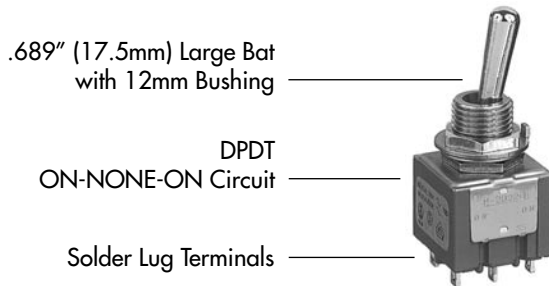

IMPORTANT:



VDE, SEMKO & SEV are marked on approved models. Switches are supplied without UL, C-UL & CSA marking unless specified. Specific models & ratings noted on General Specifications page.

POLES & CIRCUITS

Pole	Model	Toggle Position			Connected Terminals			Throw & Schematics
		Down <small>Keyway</small>	Center	Up	Down <small>Keyway</small>	Center	Up	
SP	P2011	ON	NONE	OFF	1-1b	OPEN	OPEN	SPST
SP	P2012 P2013	ON ON	NONE OFF	ON ON	1-1b	OPEN	1-1a	SPDT
DP	P2021	ON	NONE	OFF	1-1b 2-2b	OPEN	OPEN	DPST
DP	P2022 P2023	ON ON	NONE OFF	ON ON	1-1b 2-2b	OPEN	1-1a 2-2a	DPDT

TOGGLES & BUSHINGS

No Code

.512" (13.0mm)
White Cap with
6mm Bushing

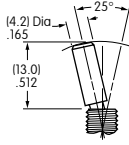

Panel Thickness
with Keyway
.134" (3.4mm)
maximum

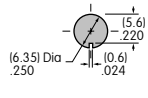

E

.450" (11.4mm)
Flatted with
6mm Bushing

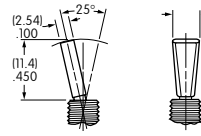

Panel Thickness
with Locking Ring
.102" (2.6mm)
maximum

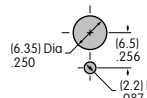

B

.689" (17.5mm)
Large Bat with
12mm Bushing

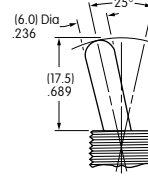

Panel Thickness
with Keyway
.256" (6.5mm)
maximum

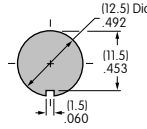

D

.748" (19.0mm)
White Capped Column
with 12mm Bushing

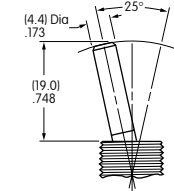

Panel Thickness
with Locking Ring
.217" (5.5mm)
maximum

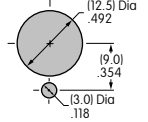

Panel Cutouts

Standard Hardware

For 6mm Bushing: 1 Locking Ring AT507M, 1 Internal Tooth Lockwasher AT509, 2 Hex Nuts AT513M

For 12mm Bushing: 1 Hex Face Nut AT503M, 1 Locking Ring AT506M, 1 Internal Tooth Lockwasher AT508, 1 Hex Mounting Nut AT527M

TERMINALS

No Code

Solder Lug

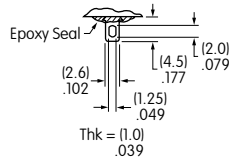

Z

.187" (4.75mm)
Quick Connect

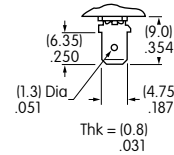

P

Straight PC

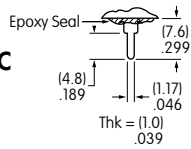

SPST

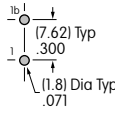

SPDT

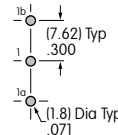

DPST

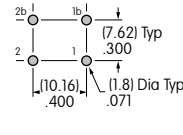

DPDT

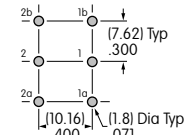

TYPICAL SWITCH DIMENSIONS

6mm Bushing

P2011, P2012, P2013



P2012

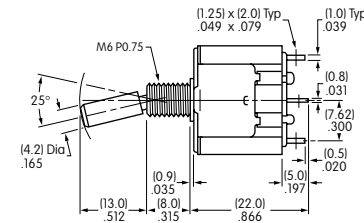
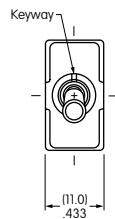

P2011 models do not have terminal 1a.

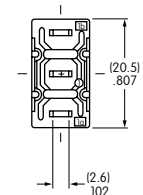

12mm Bushing

P2021B, P2022B, P2023B



P2022B

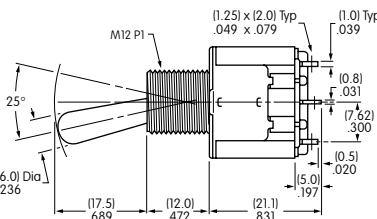
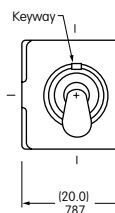

P2021 models do not have terminals 1a & 2a.

