

NPN Plastic Silicon Phototransistors

Types OP593, OP598 Series

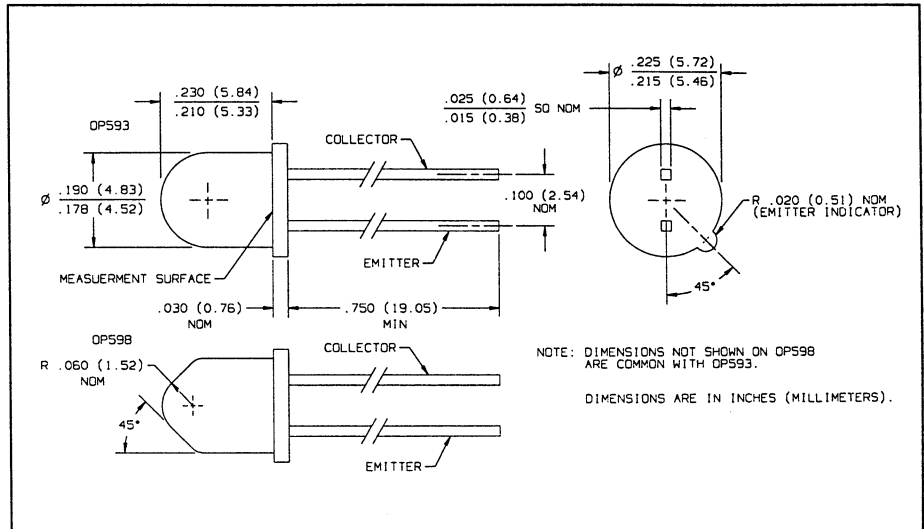
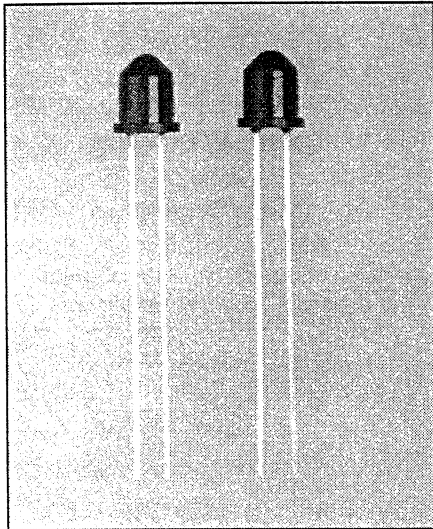

Features

- Wide receiving angle
- Variety of sensitivity ranges
- TO-18 equivalent package style

Description

The OP593/598 series consist of NPN silicon phototransistors molded in dark blue epoxy packages. The wide receiving angle provides relatively even reception over a large area. These devices are 100% production tested using infrared light for close correlation with Optek's GaAs and GaAlAs emitters.

Absolute Maximum Ratings ($T_A = 25^\circ\text{C}$ unless otherwise noted)

Collector-Emitter Voltage	30 V
Emitter-Collector Voltage	5.0 V
Continuous Collector Current	50 mA
Storage and Operating Temperature Range	-40°C to $+100^\circ\text{C}$
Lead Soldering Temperature [1/16 inch (1.6 mm) from case for 5 sec. with soldering iron]	$260^\circ\text{C}^{(1)}$
Power Dissipation	$250\text{mW}^{(2)}$

Notes:

- (1) RMA flux is recommended. Duration can be extended to 10 sec. max. when flow soldering. Max. 20 grams force may be applied to leads when soldering.
- (2) Derate linearly $3.33\text{mW}/^\circ\text{C}$ above 25°C .
- (3) $V_{CE} = 5\text{V}$. Light source is an unfiltered GaAlAs emitting diode operating at peak emission wavelength of 890 nm and $E_{e(\text{APT})}$ of $1.7\text{mW}/\text{cm}^2$ average within a .250" dia. aperture.
- (4) This dimension is held to within $\pm 0.005"$ on the flange edge and may vary up to $\pm 0.020"$ in the area of the leads.

Typical Performance Curves

Typical Spectral Response

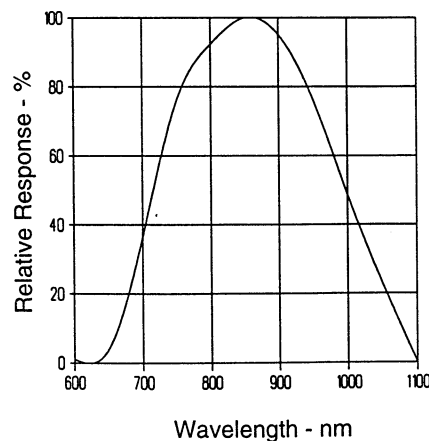

Types OP593, OP598 Series

Electrical Characteristics ($T_A = 25^\circ\text{C}$ unless otherwise noted)

SYMBOL	PARAMETER	MIN	TYP	MAX	UNITS	TEST CONDITIONS
$I_{C(ON)}$	On-State Collector Current	OP593C	1.0			See Note (3)
		OP593B	2.0		4.0	
		OP593A	3.0			
		OP598C	2.5			See Note (3)
		OP598B	5.0		10	
		OP598A	7.5			
I_{CEO}	Collector Dark Current			100	nA	$V_{CE} = 10\text{ V}, E_e = 0$
$V_{(BR)CEO}$	Collector-Emitter Breakdown Voltage	30			V	$I_C = 100\ \mu\text{A}$
$V_{(BR)ECO}$	Emitter-Collector Breakdown Voltage	5			V	$I_E = 100\ \mu\text{A}$
$V_{CE(SAT)}$	Collector-Emitter Saturation Voltage			0.40	V	$I_C = 0.4\text{ mA}, E_e = 1.7\text{ mW/cm}^2(3)$

PHOTOSENSORS

Typical Performance Curves

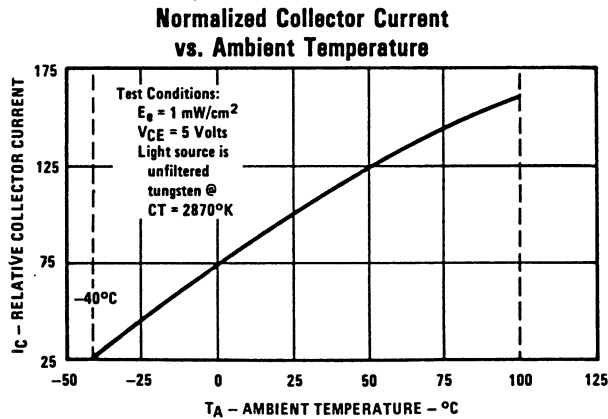
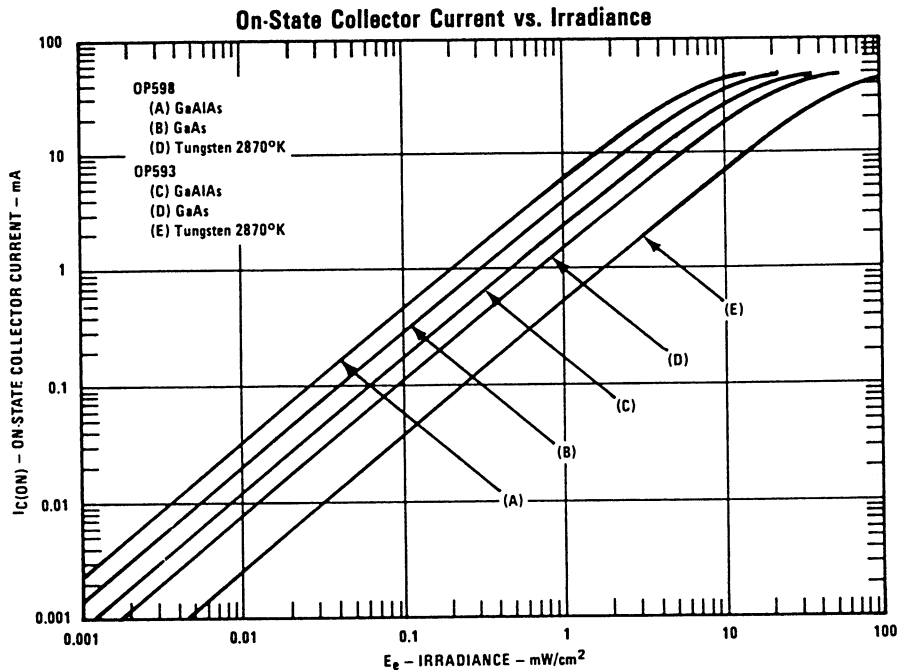

Typical Performance Curves

Collector Dark Current vs. Ambient Temperature

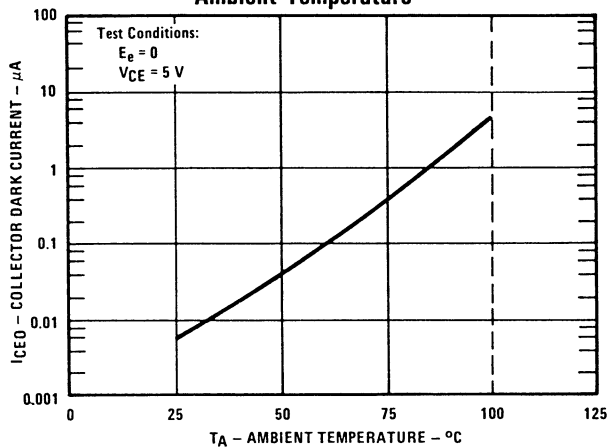

Relative Collector Current vs. Angular Displacement

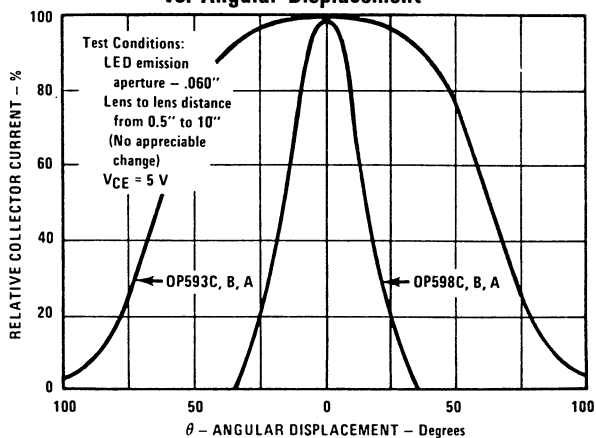

Collector Current vs. Collector to Emitter Voltage

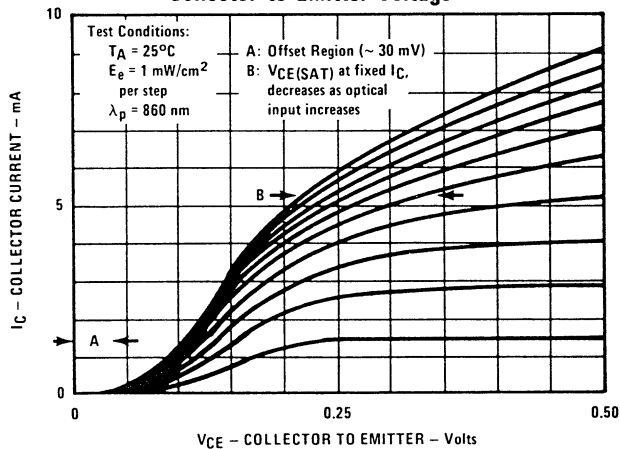

Rise and Fall Time vs. Load Resistance

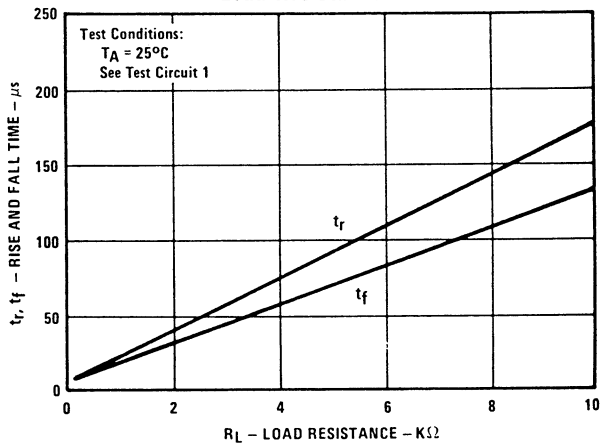

Normalized Output vs. Frequency

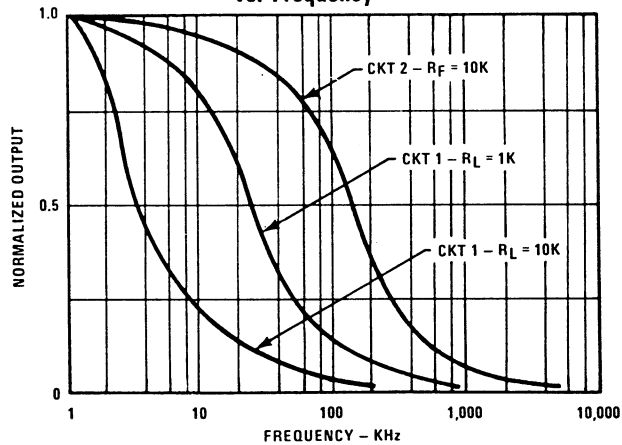

Switching Time Test Circuit

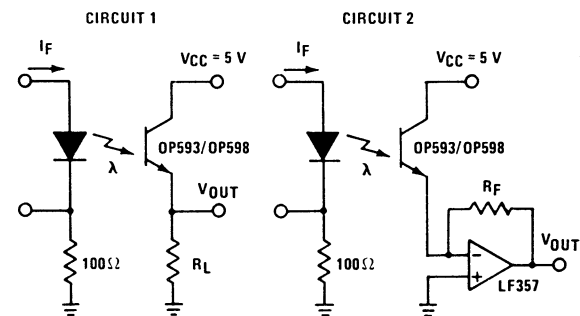

Test Conditions:
 Light source is pulsed LED with t_r and $t_f \leq 500\text{ ns}$.
 I_F is adjusted for $V_{OUT} = 1\text{ Volt}$.

Types OP593, OP598 Series

Typical Performance Curves

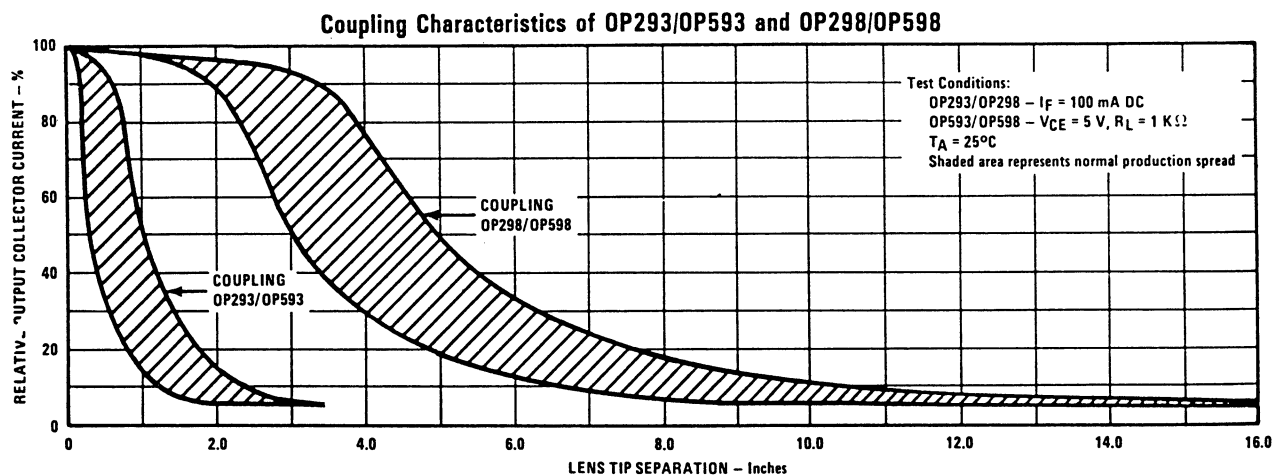
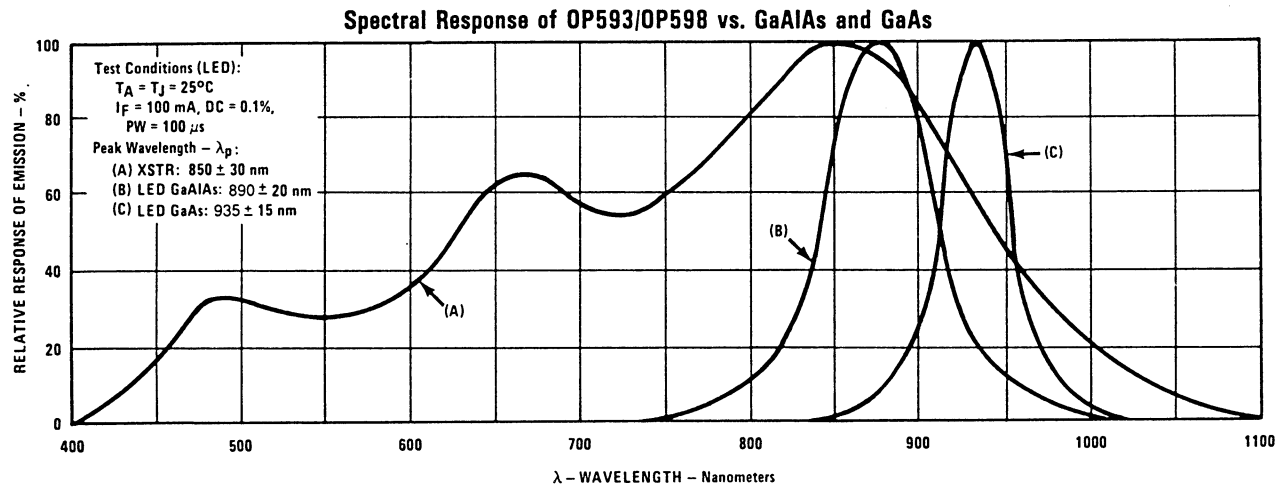
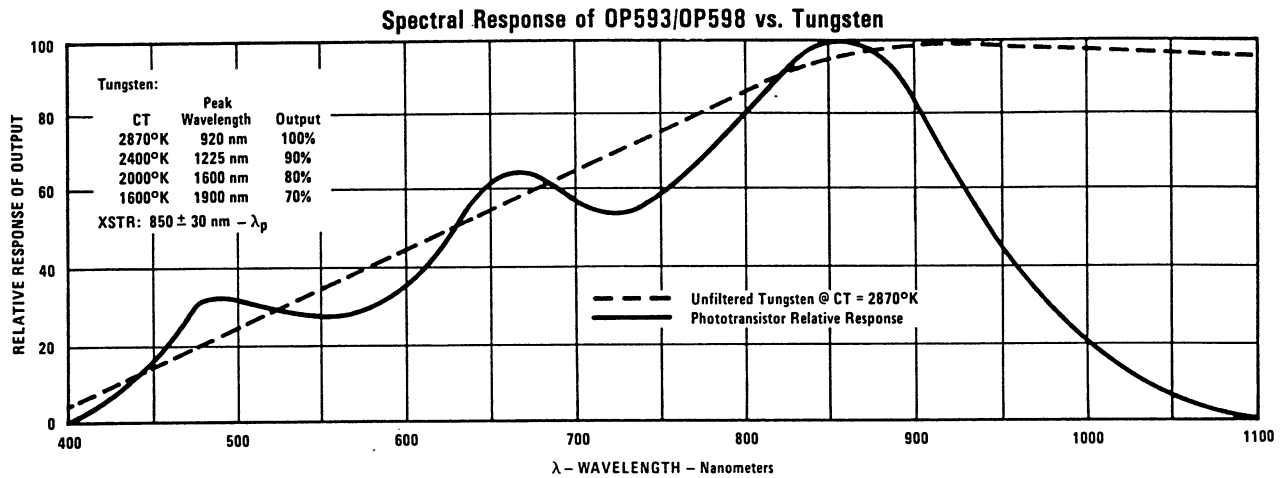

Optek reserves the right to make changes at any time in order to improve design and to supply the best product possible.

Optek Technology, Inc. 1215 W. Crosby Road Carrollton, Texas 75006 (972)323-2200 Fax (972)323-2396