

NPN Silicon Photodarlington Types OP565A, OP565B, OP565C

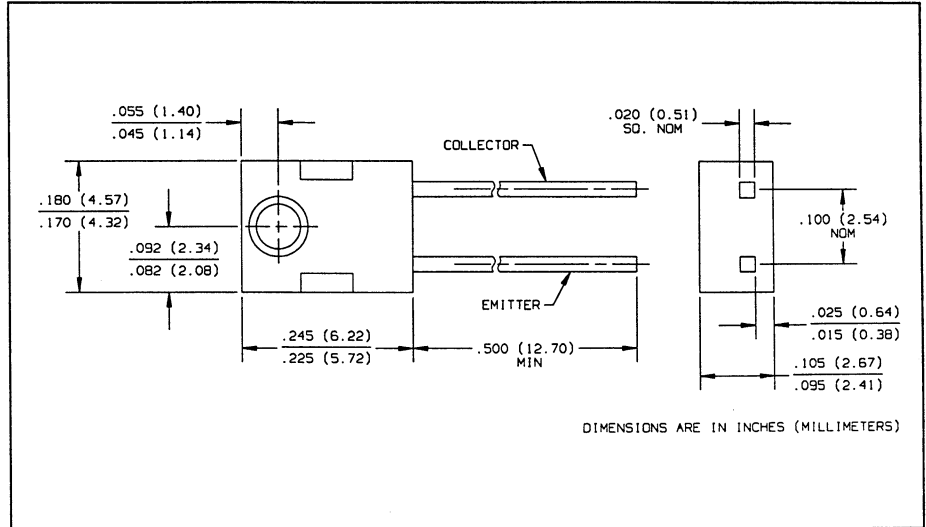
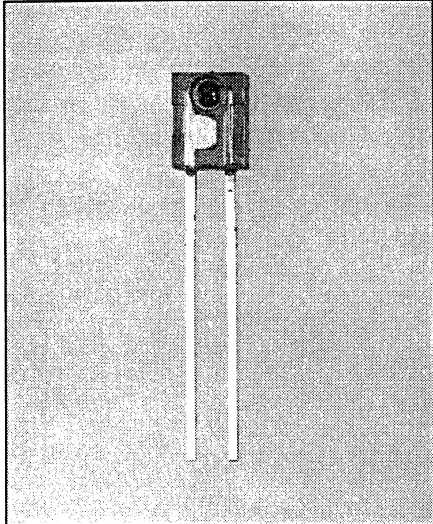

Features

- Variety of sensitivity ranges
- High current gain
- Side-looking package for space limited applications

Description

The OP565 series consist of NPN silicon photodarlington molded in green-tinted epoxy packages. The lensing effect allows an acceptance half angle of 28° measured from the optical axis to the half power point. Photodarlington devices are normally used in applications where light signal levels are low and more current gain is needed than is possible with phototransistors. The side-looking package is designed for easy PC board mounting of slotted optical switches or optical interrupt detectors. These devices are 100% production tested using infrared light for close correlation with Optek GaAs and GaAlAs emitters.

Absolute Maximum Ratings ($T_A = 25^\circ\text{C}$ unless otherwise noted)

Collector-Emitter Voltage	15.0 V
Emitter-Collector Voltage	5.0 V
Storage and Operating Temperature Range	-40°C to $+100^\circ\text{C}$
Lead Soldering Temperature [1/16 inch (1.6 mm) from case for 5 sec. with soldering iron]	$260^\circ\text{C}^{(1)}$
Power Dissipation	$100\text{ mW}^{(2)}$

Notes:

- (1) RMA flux is recommended. Duration can be extended to 10 sec. max. when flow soldering. Max. 20 grams force may be applied to leads when soldering.
- (2) Derate linearly $1.33\text{ mW}/^\circ\text{C}$ above 25°C .
- (3) Light source is an unfiltered GaAs LED with a peak emission wavelength of 930 nm and a radiometric intensity level which varies less than 10% over the entire lens surface of the phototransistor being tested.

Typical Performance Curves

Typical Spectral Response

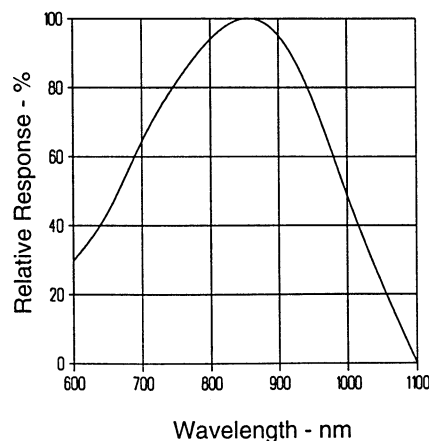

Coupling Characteristics
OP145 and OP565

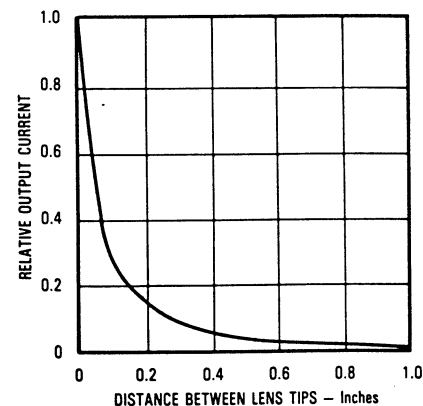

Types OP565A, OP565B, OP565C

Electrical Characteristics ($T_A = 25^\circ\text{C}$ unless otherwise noted)

SYMBOL	PARAMETER	MIN	TYP	MAX	UNITS	TEST CONDITIONS
$I_{C(ON)}$	On-State Collector Current	OP565C	1.1		mA	$V_{CE} = 2\text{ V}, E_e = 0.1\text{ mW/cm}^2(3)$
		OP565B	3.3	9.8	mA	
		OP565A	6.6		mA	
I_{CEO}	Collector Dark Current			100	nA	$V_{CE} = 10\text{ V}, E_e = 0$
$V_{(BR)CEO}$	Collector-Emitter Breakdown Voltage	15			V	$I_C = 1\text{ mA}, E_e = 0$
$V_{(BR)ECO}$	Emitter-Collector Breakdown Voltage	5			V	$I_E = 100\text{ }\mu\text{A}, E_e = 0$
$V_{CE(SAT)}$	Collector-Emitter Saturation Voltage			1.10	V	$I_C = 0.4\text{ mA}, E_e = 0.1\text{ mW/cm}^2(3)$

Typical Performance Curves

Collector Dark Current vs. Ambient Temperature

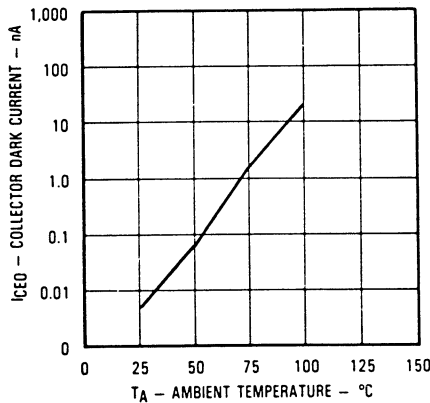

Collector Current vs. Ambient Temperature

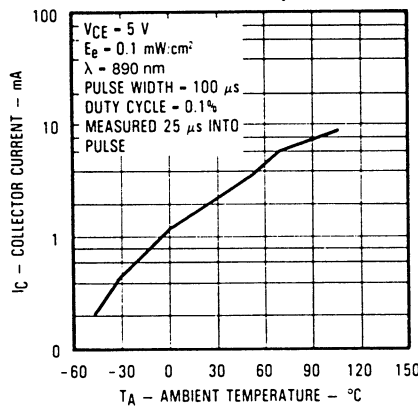

Collector Current vs. Irradiance

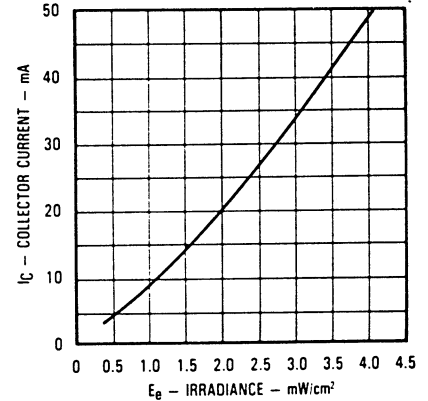

Rise and Fall Time vs. Load Resistance

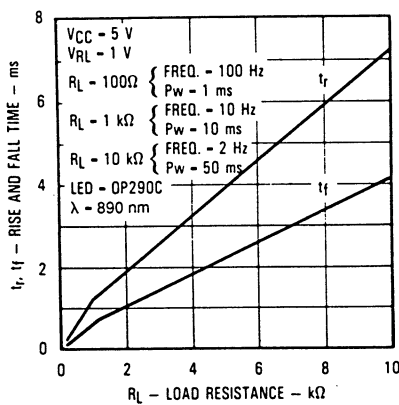

Normalized Collector Current vs. Angular Displacement

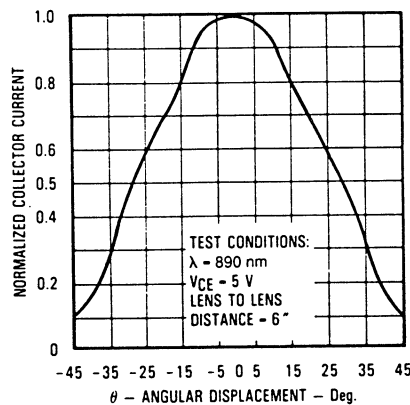

Switching Time Test Circuit

