

FEATURES

- **Ultrahigh Speed: 100Mbps**
- **Guaranteed Propagation Delay: 8ns ±4ns Over Temperature**
- 50Mbps Operation with $V_{DD} = 3V$
- **Low Channel-to-Channel Skew: 500ps Typ**
- Low t_{PLH}/t_{PHL} Skew: 500ps Typ
- **Hot Swap™ Capable**
- Driver Outputs Maintain High Impedance in Three-State or with Power Off
- Short-Circuit Protected: 3mA Typ Output Current for an Indefinite Short
- Thermal Shutdown Protected
- Single 5V or 3V Supply
- Pin Compatible with LTC486/LTC487

APPLICATIONS

- High Speed RS485 Twisted-Pair Drivers
- High Speed Backplane Drivers
- Complementary Clock Drivers
- STS-1/OC-1 Data Drivers
- SCSI Drivers

DESCRIPTION

The LTC[®]1688/LTC1689 are ultrahigh speed, differential bus/line drivers that can operate at data rates up to 100Mbps. Propagation delay is guaranteed at 8ns ±4ns over the full operating temperature range. These devices operate over the full RS485 common mode range (–7V to 12V), and also meet RS422 requirements.

The driver outputs are Hot Swap capable, maintaining backplane data integrity during board insertion and removal. The drivers feature three-state outputs, maintaining high impedance over the entire common mode range (–7V to 12V). Outputs also remain high impedance during power-up and with the power off. A short-circuit feature detects bus contention and substantially reduces driver output current. Thermal shutdown circuitry protects the parts from excessive power dissipation.

The LTC1688 allows all four drivers to be enabled together, while the LTC1689 allows two drivers at a time to be enabled.

The LTC1688/LTC1689 operate from a single 5V or 3V supply and draw only 9mA of supply current.

LT, LTC and LT are registered trademarks of Linear Technology Corporation. Hot Swap is a trademark of Linear Technology Corporation.

TYPICAL APPLICATION

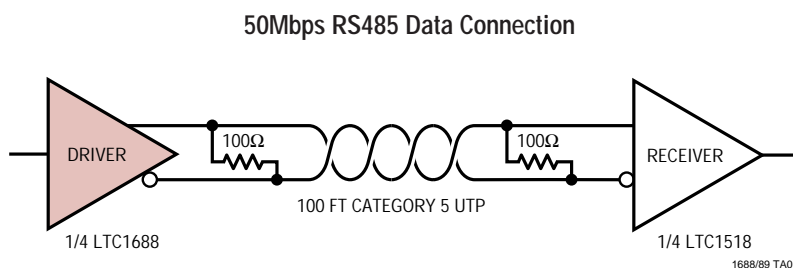

20ns Pulse Across 100 Feet of Category 5 UTP

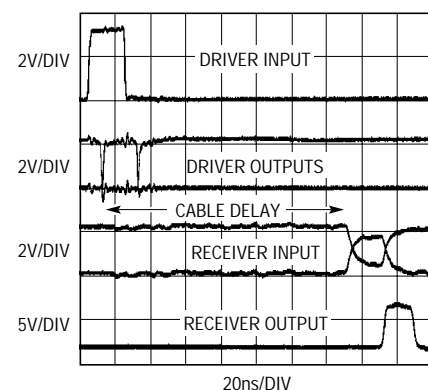

ABSOLUTE MAXIMUM RATINGS

(Note 1)

Supply Voltage (V_{DD})	7V
Enable Input Voltages	-0.5V to ($V_{DD} + 0.5V$)
Enable Input Currents	-100mA to 100mA
Driver Input Voltages	-0.5V to ($V_{DD} + 0.5V$)
Driver Output Voltages	(-12V + V_{DD}) to 12V
Driver Input Currents	-100mA to 100mA
Short-Circuit Duration (V_{OUT} : -7V to 10V)	Indefinite
Operating Temperature Range	0°C to 70°C
Storage Temperature Range	-65°C to 150°C
Lead Temperature (Soldering, 10 sec)	300°C

PACKAGE/ORDER INFORMATION

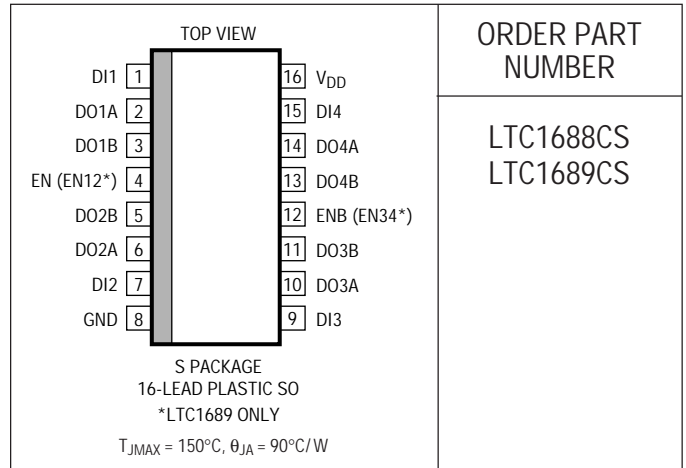

ORDER PART NUMBER

LTC1688CS
LTC1689CS

Consult factory for Industrial and Military grade parts.

DC ELECTRICAL CHARACTERISTICS

The ● denotes the specifications which apply over the full operating temperature range, otherwise specifications are at $T_A = 25^\circ\text{C}$.

SYMBOL	PARAMETER	CONDITIONS	MIN	TYP	MAX	UNITS
$V_{DD} = 5V$, Per Driver, $T_A = 25^\circ\text{C}$, Unless Otherwise Noted (Note 2)						
V_{OD1}	Differential Driver Output (Unloaded)	$I_{OUT} = 0$	●		V_{DD}	V
V_{OD2}	Differential Driver Output (With Load)	$R = 50\Omega$ (RS422) $R = 25\Omega$ (RS485), Figure 1	●	2		V
			●	1.5	3.0	V
ΔV_{OD}	Change in Magnitude of Driver Differential Output Voltage for Complementary Output States	$R = 25\Omega$ or 50Ω , Figure 1	●		0.2	V
V_{OC}	Driver Common Mode Output Voltage	$R = 25\Omega$ or 50Ω , Figure 1	●	2	3	V
$\Delta V_{OC} $	Change in Magnitude of Driver Common Mode Output Voltage for Complementary Output States	$R = 25\Omega$ or 50Ω , Figure 1	●		0.2	V
V_{IH}	Input High Voltage	EN, ENB, EN12, EN34, DI	●	2		V
V_{IL}	Input Low Voltage	EN, ENB, EN12, EN34, DI	●		0.8	V
I_{IN1}	Input Current	EN, ENB, EN12, EN34, DI	●		± 1	μA
I_{OZ}	Three-State (High Impedance) Output Current	$V_{OUT} = -7V$ to 12V	●	± 2	± 200	μA
I_{DD}	Supply Current of Entire Device	No Load, Digital Input Pins = 0V or V_{DD}	●	9	18	mA
I_{OSD1}	Driver Short-Circuit Current, $V_{OUT} = \text{HIGH}$	$V_{OUT} = -7V$ to 10V	●		± 20	mA
I_{OSD2}	Driver Short-Circuit Current, $V_{OUT} = \text{LOW}$	$V_{OUT} = -7V$ to 10V	●		± 20	mA
$V_{DD} = 3V$, Per Driver, $T_A = 25^\circ\text{C}$, Unless Otherwise Noted (Note 2)						
V_{OD1}	Differential Driver Output (Unloaded)	$I_{OUT} = 0$	●		V_{DD}	V
V_{OD2}	Differential Driver Output (With Load)	$R = 50\Omega$ (RS422) $R = 25\Omega$ (RS485), Figure 1	●	0.65	1.5	V
			●		2.0	V
ΔV_{OD}	Change in Magnitude of Driver Differential Output Voltage for Complementary Output States	$R = 25\Omega$ or 50Ω , Figure 1		0.1		V
V_{OC}	Driver Common Mode Output Voltage	$R = 25\Omega$ or 50Ω , Figure 1		1.3		V

DC ELECTRICAL CHARACTERISTICS

The ● denotes the specifications which apply over the full operating temperature range, otherwise specifications are at $T_A = 25^\circ\text{C}$.

SYMBOL	PARAMETER	CONDITIONS	MIN	TYP	MAX	UNITS
$\Delta V_{OC} $	Change in Magnitude of Driver Common Mode Output Voltage for Complementary Output States	R = 25 Ω or 50 Ω , Figure 1		0.1		V
V_{IH}	Input High Voltage	EN, ENB, EN12, EN34, DI ●	1.4			V
V_{IL}	Input Low Voltage	EN, ENB, EN12, EN34, DI ●			0.5	V
I_{IN1}	Input Current	EN, ENB, EN12, EN34, DI (Note 3) ●			± 1	μA
I_{OZ}	Three-State (High Impedance) Output Current	$V_{OUT} = -7\text{V to }10\text{V}$ (Note 3) ●		± 1	± 200	μA
I_{DD}	Supply Current of Entire Device	No Load, Digital Input Pins = 0V or V_{DD}		5		mA
I_{OSD1}	Driver Short-Circuit Current, $V_{OUT} = \text{HIGH}$	$V_{OUT} = -7\text{V to }8\text{V}$ (Note 3) ●			± 20	mA
I_{OSD2}	Driver Short-Circuit Current, $V_{OUT} = \text{LOW}$	$V_{OUT} = -7\text{V to }8\text{V}$ (Note 3) ●			± 20	mA

SWITCHING CHARACTERISTICS

The ● denotes the specifications which apply over the full operating temperature range, otherwise specifications are at $T_A = 25^\circ\text{C}$.

SYMBOL	PARAMETER	CONDITIONS	MIN	TYP	MAX	UNITS
$V_{DD} = 5\text{V}$, $T_A = 25^\circ\text{C}$, Unless Otherwise Noted (Note 2)						
t_{PLH} , t_{PHL}	Driver Input-to-Output Propagation Delay	$R_{DIFF} = 50\Omega$, $C_{L1} = C_{L2} = 25\text{pF}$, Figures 2, 4 ●	4	8	12	ns
t_{SKEW}	Driver Output-to-Output Skew	$R_{DIFF} = 50\Omega$, $C_{L1} = C_{L2} = 25\text{pF}$, Figures 2, 4		500		ps
t_r , t_f	Driver Rise/Fall Time	$R_{DIFF} = 50\Omega$, $C_{L1} = C_{L2} = 25\text{pF}$, Figures 2, 4		2		ns
t_{ZH}	Driver Enable to Output High	$C_L = 25\text{pF}$, S2 Closed, Figures 3, 5 ●		10	35	ns
t_{ZL}	Driver Enable to Output Low	$C_L = 25\text{pF}$, S1 Closed, Figures 3, 5 ●		10	35	ns
t_{LZ}	Driver Disable from Low	$C_L = 15\text{pF}$, S1 Closed, Figures 3, 5 ●		25	65	ns
t_{HZ}	Driver Disable from High	$C_L = 15\text{pF}$, S2 Closed, Figures 3, 5 ●		25	65	ns
$C_{L(MAX)}$	Maximum Output Capacitive Load	(Note 3) ●			200	pF
	Maximum Data Rate	(Note 3) ●	100			Mbps
	Maximum Driver Input Rise/Fall Time	(Note 3) ●			500	ns
$V_{DD} = 3\text{V}$, $T_A = 25^\circ\text{C}$, Unless Otherwise Noted (Note 2)						
t_{PLH} , t_{PHL}	Driver Input-to-Output Propagation Delay	$R_{DIFF} = 50\Omega$, $C_{L1} = C_{L2} = 25\text{pF}$, Figures 2, 4		11		ns
t_{SKEW}	Driver Output-to-Output Skew	$R_{DIFF} = 50\Omega$, $C_{L1} = C_{L2} = 25\text{pF}$, Figures 2, 4		1		ns
t_r , t_f	Driver Rise/Fall Time	$R_{DIFF} = 50\Omega$, $C_{L1} = C_{L2} = 25\text{pF}$, Figures 2, 4		4		ns
t_{ZH}	Driver Enable to Output High	$C_L = 25\text{pF}$, S2 Closed, Figures 3, 5		25		ns
t_{ZL}	Driver Enable to Output Low	$C_L = 25\text{pF}$, S1 Closed, Figures 3, 5		25		ns
t_{LZ}	Driver Disable from Low	$C_L = 15\text{pF}$, S1 Closed, Figures 3, 5		50		ns
t_{HZ}	Driver Disable from High	$C_L = 15\text{pF}$, S2 Closed, Figures 3, 5		50		ns
$C_{L(MAX)}$	Maximum Output Capacitive Load	(Note 3) ●			200	pF
	Maximum Data Rate			50		Mbps
	Maximum Driver Input Rise/Fall Time	(Note 3) ●			500	ns

Note 1: Absolute Maximum Ratings are those values beyond which the life of a device may be impaired.

Note 2: All currents into the device pins are positive; all currents out of the device pins are negative.

Note 3: Guaranteed by design or correlation, but not tested.

TYPICAL PERFORMANCE CHARACTERISTICS

Propagation Delay vs Temperature

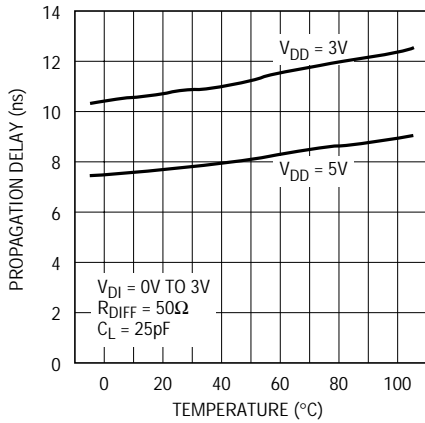

1688/89 G01

Propagation Delay vs Load Capacitance

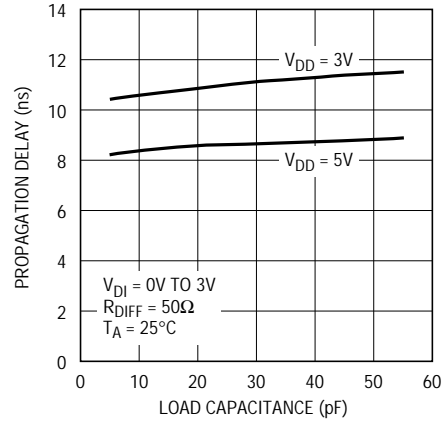

1688/89 G02

Supply Current vs Data Rate

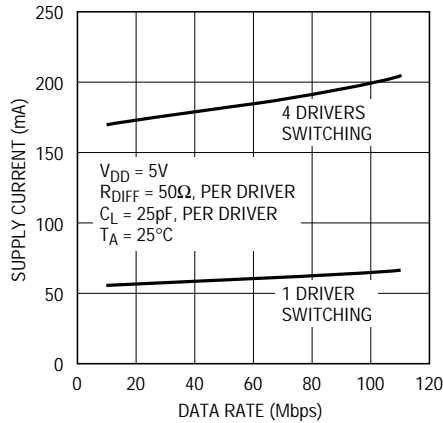

1688/89 G03

Three-State Output Current

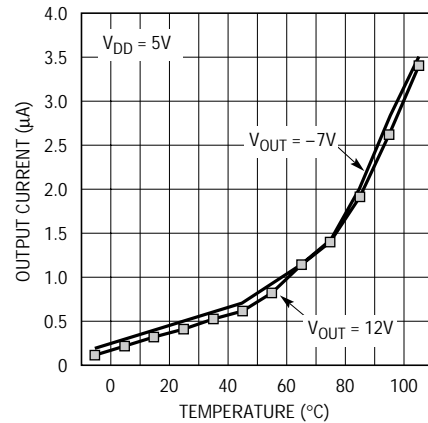

1688/89 G04

V_{OD2} vs Temperature

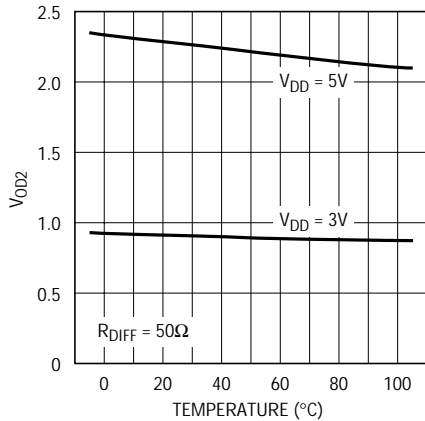

1688/89 G05

I_{DD} vs Temperature

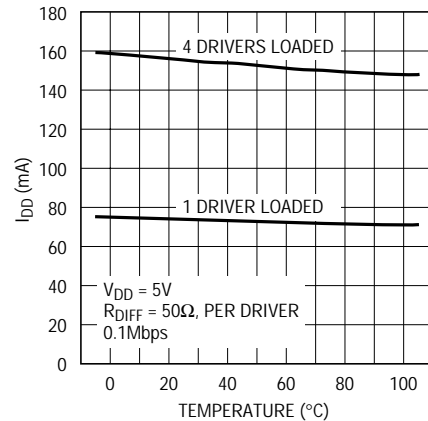

1688/89 G06

PIN FUNCTIONS

DI1 (Pin 1): Driver 1 Input. Do not float.

DO1A (Pin 2): Driver 1 Noninverting Output.

DO1B (Pin 3): Driver 1 Inverting Output.

EN (Pin 4, LTC1688): High True Enable Pin, enables all four drivers. A low on Pin 4 and a high on Pin 12 will put all driver outputs into a high impedance state. See Function Tables for details. Do not float.

EN12 (Pin 4, LTC1689): Enables Drivers 1 and 2. A low on Pin 4 will put the outputs of drivers 1 and 2 into a high impedance state. See Function Tables for details. Do not float.

DO2B (Pin 5): Driver 2 Inverting Output.

DO2A (Pin 6): Driver 2 Noninverting Output.

DI2 (Pin 7): Driver 2 Input. Do not float.

GND (Pin 8): Ground Connection. A good ground plane is recommended for all applications.

DI3 (Pin 9): Driver 3 Input. Do not float.

DO3A (Pin 10): Driver 3 Noninverting Output.

DO3B (Pin 11): Driver 3 Inverting Output.

ENB (Pin 12, LTC1688): Low True Enable Pin, enables all four drivers. A low on Pin 4 and a high on Pin 12 will put all driver outputs into a high impedance state. See Function Tables for details. Do not float.

EN34 (Pin 12, LTC1689): Enables Drivers 3 and 4. A low on Pin 12 will put the outputs of drivers 3 and 4 into a high impedance state. See Function Tables for details. Do not float.

DO4B (Pin 13): Driver 4 Inverting Output.

DO4A (Pin 14): Driver 4 Noninverting Output.

DI4 (Pin 15): Driver 4 Input. Do not float.

V_{DD} (Pin 16): Power Supply Input. This pin should be bypassed with a 0.1 μ F ceramic capacitor as close to the pin as possible. Recommended: V_{DD} = 3V to 5.25V.

FUNCTION TABLES

LTC1688

INPUTS			OUTPUTS	
DI	EN	ENB	OUTA	OUTB
H	H	X	H	L
L	H	X	L	H
H	X	L	H	L
L	X	L	L	H
X	L	H	HI-Z	HI-Z

LTC1689

INPUTS		OUTPUTS	
DI	EN12/EN34	OUTA	OUTB
H	H	H	L
L	H	L	H
X	L	HI-Z	HI-Z

TEST CIRCUITS

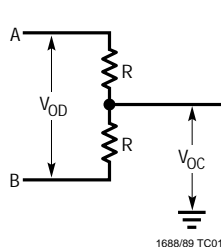

Figure 1. Driver DC Test Load

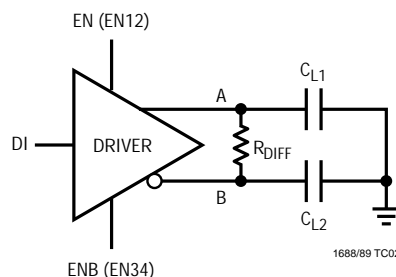

Figure 2. Driver Timing Test Circuit

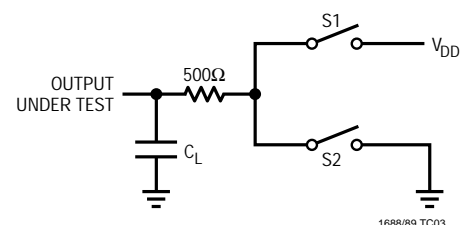

Figure 3. Driver Timing Test Load

SWITCHING TIME WAVEFORMS

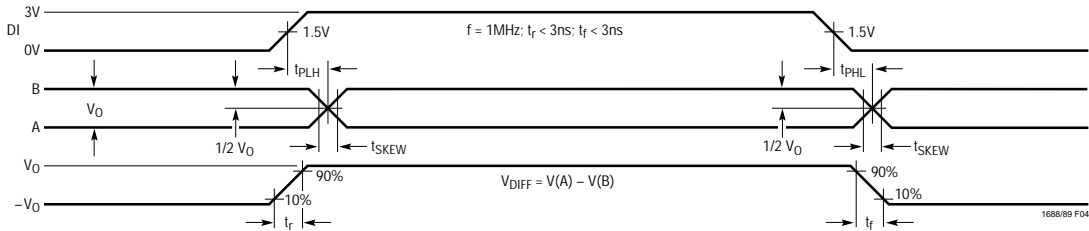

Figure 4. Driver Propagation Delays

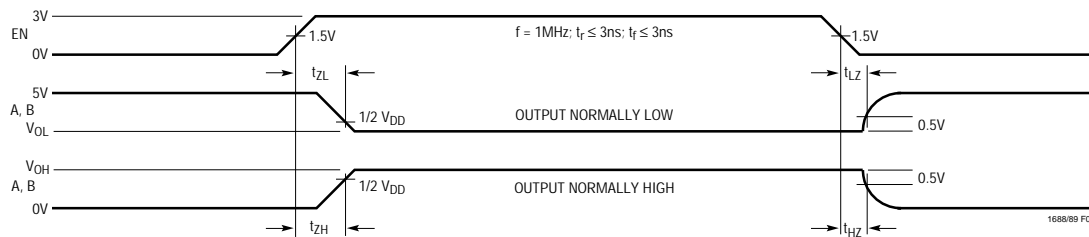

Figure 5. Driver Enable and Disable Times

APPLICATIONS INFORMATION

The LTC1688/LTC1689 family of RS485 quad differential drivers employs a novel architecture and fabrication process that allows ultra high speed operation (100Mbps) and Hot Swap capability while maintaining the ruggedness of RS485 operation (three-state outputs can float from -7V to 12V with a single 5V supply). Unlike typical CMOS drivers whose propagation delay can vary as much as 500%, the propagation delay of the LTC1688/LTC1689 drivers will only vary by $\pm 50\%$ (a narrow $\pm 4\text{ns}$ window). This performance is achieved by designing the input stage of each driver to have minimum propagation delay shift over temperature and from part to part.

The LTC1688/LTC1689 have an ESD rating of 6kV human body model.

50Mbps with 3V Operation

The LTC1688/LTC1689 are designed to operate with a 3V power supply and still achieve 50Mbps operation (see Electrical Characteristics table for 3V DC and AC specifica-

tions). Figure 6 shows waveforms of an LTC1689 driving a receiver using 100 feet of Category 5 UTP. Both parts are operating at 3V supply.

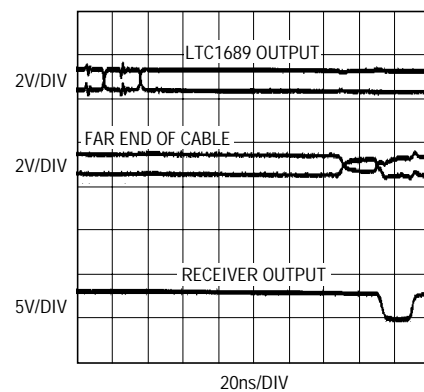

Figure 6. 3V High Speed Data Transmission

APPLICATIONS INFORMATION

Hot Swap Capability

With the LTC1688/LTC1689 outputs disabled but connected to the transmission line, the user can turn on/off the power to the LTC1688/LTC1689 without inducing a differential signal on the transmission line. Due to capacitive coupling, however, there can be a small amount of common mode charge injected into both disabled outputs, which is not seen as a differential signal (see Figure 7). The disabled outputs can be hooked/unhooked to a transmission line without disturbing the existing data.

Output Short-Circuit Protection

In addition to 100Mbps operation and Hot Swap capability, the LTC1688/LTC1689 employ voltage sensing short-circuit protection that reduces short-circuit current by over an order of magnitude. For a given input polarity, this circuitry determines what the correct output level should be. If the output level is different from the expected, the circuitry shuts off the big output devices. Much smaller devices are instead turned on, thus producing a much smaller short-circuit output current (3mA typical). For example, if the driver input is > 2V, it expects the "A" output to be > 3.25V and the "B" output to be less than 1.75V. If the "A" output is subsequently shorted to a voltage below

$V_{DD}/2$, this circuitry shuts off the big outputs and turns on 3mA current sources instead (the converse applies to the "B" output). Note that these 3mA current sources are active only during a short-circuit fault. During normal operation, the regular output drivers can sink/source >50mA.

A time-out period of about 50ns is required before a short-circuit fault is detected. This circuitry might falsely detect a short under excess output capacitive load (>200pF). Additionally, a short might go undetected if there is too much resistance (user inserted or cable parasitic) between the physical short and the actual driver output.

For cables with the recommended RS485 termination (no DC bias on the cable, see Figure 8), the LTC1688/LTC1689 will automatically come out of short-circuit mode once the physical short has been removed.

To prevent permanent damage to the part, the maximum allowable short is 10V (not 12V). Note that during a short, the voltage right at the pin should not ring to a voltage higher than 12V. Instability could surface if the short is made with long leads (parasitic inductance). Once the short is removed, the instability will disappear.

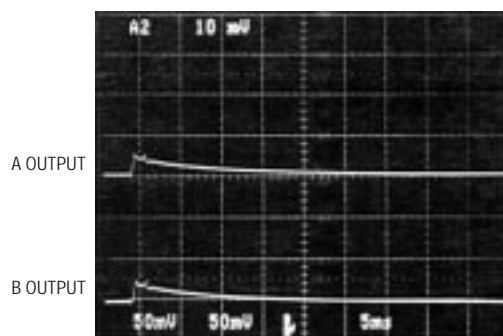

Figure 7. Common Mode Charge Injection During Hot Swapping

APPLICATIONS INFORMATION

Cable Termination

The recommended cable termination for use with the LTC1688/LTC1689 is a single resistor across the two ends of a transmission cable (see Figure 8). When PC traces are used as the transmission line, its characteristic impedance should be chosen close to 100Ω in order to better match the specified timing characteristics of the LTC1688/LTC1689. Category 5 unshielded twisted pair can be used over short distances at the maximum data rates (100Mbps). For point-to-point configurations (see Figure 9), a single resistor across the cable at the receiver end is sufficient. A single resistor termination lowers power consumption and increases the differential output signal. See Enable Pins section for cable terminations with a DC bias.

Enable Pins

For cable terminations with a DC bias (such as High Voltage Differential SCSI, see Figure 10), the driver outputs must be disabled for at least 200ns after power-up. This ensures that the driver outputs do not disturb the cable upon power-up. It also ensures the correct output start-up conditions. When there is an output short fault condition and the cable has a DC biased termination, such as Figure 10, the driver outputs must be disabled for at least 200ns after the short has been removed. Recall that for transmission lines that have the recommended RS485 single resistor termination (Figures 8 and 9), the LTC1688/LTC1689 will come out of a short-circuit fault condition automatically without having to disable the outputs.

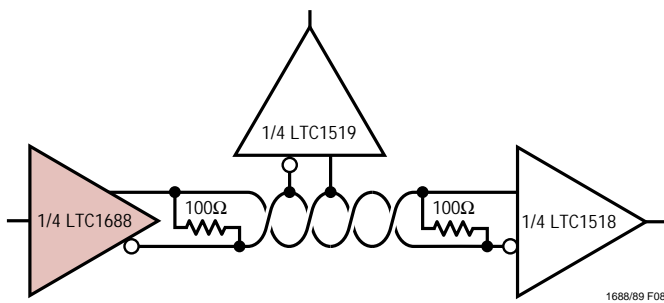

Figure 8. Multipoint Transmission

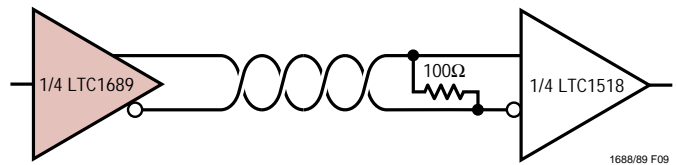

Figure 9. Point-to-Point Transmission

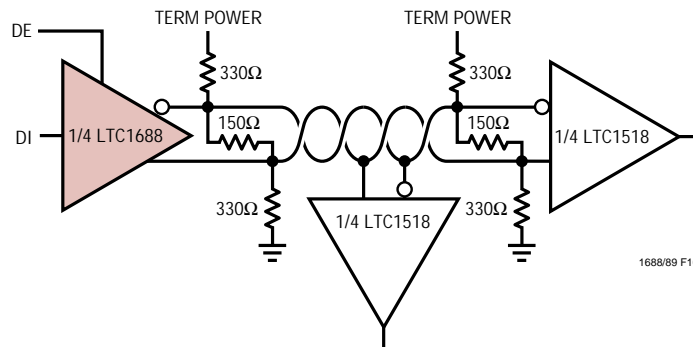

Figure 10. DC-Biased Termination
(Recommended for SCSI Applications Only)

APPLICATIONS INFORMATION

High Speed Twisted-Pair Transmission

Data rates up to 100Mbps can be transmitted over short distances using Category 5 UTP (unshielded twisted pair). The cable distance will determine the maximum data rate. Figures 11 and 12 show an 8ns pulse propagating over 25 feet of Category 5 UTP. Notice how the cable attenuates the signal. Lucent Technologies' BRF2A and BRS2A receivers are recommended for these ultrahigh speed applications.

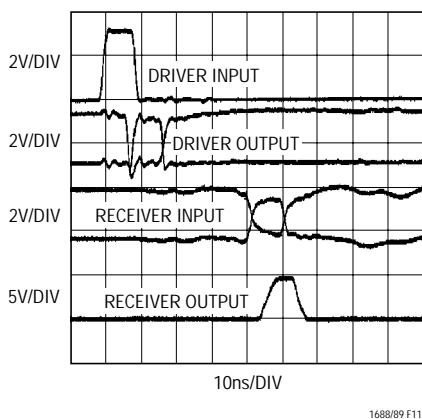

Figure 11. 8ns Pulse Over 25 Feet Category 5 UTP

High Speed Backplane Transmission

The LTC1688/LTC1689 can be used in backplane point-to-point and multipoint applications. At high data rates, signals should be routed differentially and PC traces should be terminated (see Figure 13). Note that the RS485 specification calls for characteristic impedances near 100Ω; therefore, PC trace transmission lines should be designed with an impedance close to 100Ω. If trace impedance is much less than 100Ω, and the trace is double terminated, the part will experience excess heating. The propagation delay could then fall outside the specified window. The LT1720 dual UltraFast™ comparator is a good choice for high data rate backplane applications.

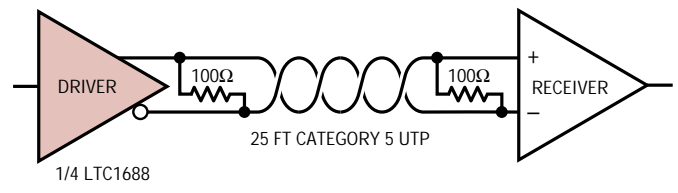

Figure 12. 100Mbps Differential Data Connection

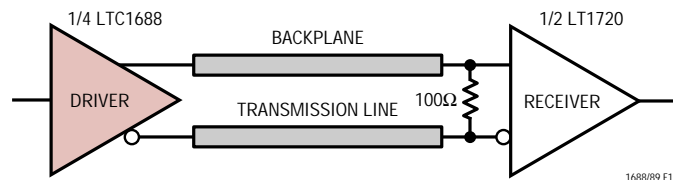

Figure 13. 100Mbps Backplane Transmission

UltraFast is a trademark of Linear Technology Corporation.

APPLICATIONS INFORMATION

Layout Considerations

A ground plane is recommended when using high frequency devices like the LTC1688/LTC1689. A 0.1 μ F ceramic bypass capacitor less than 0.25 inch away from the V_{DD} pin is also recommended. Special care should be taken to route the differential outputs very symmetrically in order to obtain the same parasitic capacitances and thus maintain good propagation delay skew.

Parasitic capacitance from each input to its corresponding outputs should also be minimized. Any excess capacitance could result in slower operation or even instability. Channel output pairs should be kept away from other output pairs to avoid parasitic coupling.

Data Rate vs Cable Length

Cable length and quality limit the maximum data rate in a twisted pair system. Category 5 unshielded twisted pair is a good choice for high speed data transmission, as it exhibits superior bandwidth over other cables of similar cost.

Driver and receiver bandwidth affects the maximum data rate only over distances of less than 100', even for the best cables. The LTC1688/LTC1689 RS485 drivers and LTC1518/LTC1519 52Mbps RS485 receivers are the fastest in the industry. The LTC1688/LTC1689 drivers can reach speeds over 100Mbps, with a rise and fall time of just 2ns. At speeds in excess of 52Mbps, the non-RS485 Lucent Technologies' BRF2A receiver is recommended.

Detailed information on data rate vs cable length is provided by the cable manufacturer. They characterize their cables for bit rate and 0% to 50% rise time vs cable length, allowing a rapid comparison of various cable types.

The following oscilloscope waveforms illustrate how a cable attenuates the signal and slows its rise time at different lengths. Also shown are the driver input and receiver output.

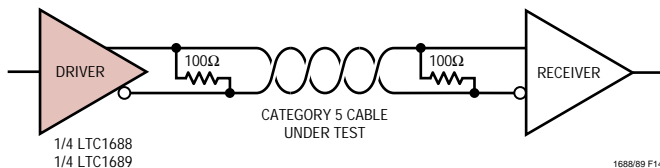

Figure 14. Test Circuit for Cable Speed Evaluation

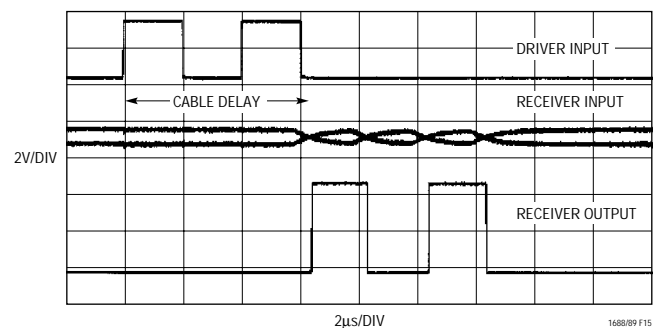

Figure 15. 4000 Feet, 0.5Mbps, LTC1518 Receiver

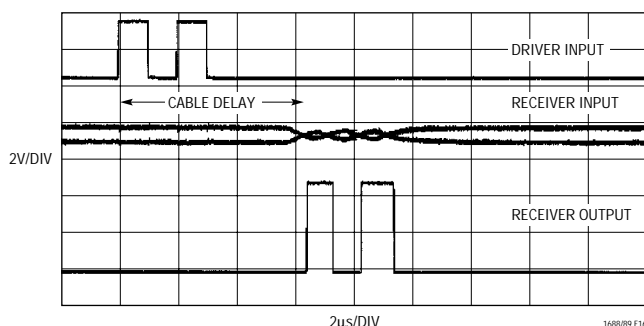

Figure 16. 4000 Feet, 1Mbps, LTC1518 Receiver

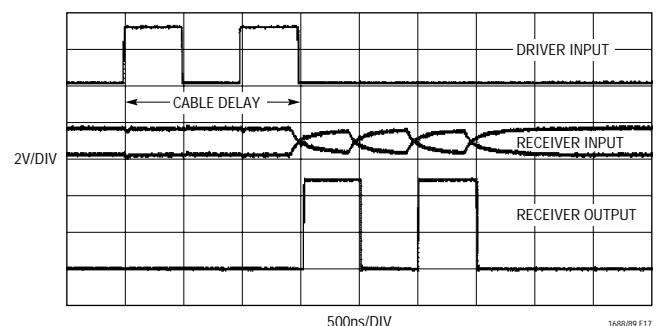

Figure 17. 1000 Feet, 2Mbps, LTC1518 Receiver

APPLICATIONS INFORMATION

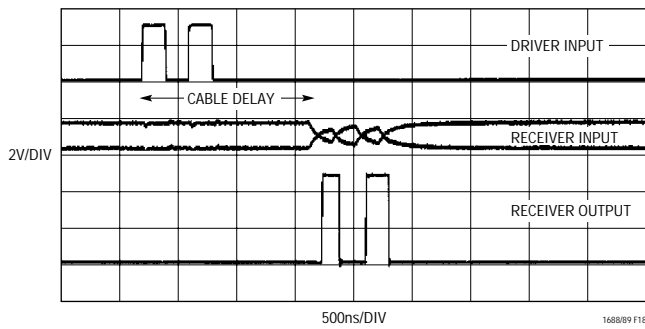

Figure 18. 1000 Feet, 5Mbps, LTC1518 Receiver

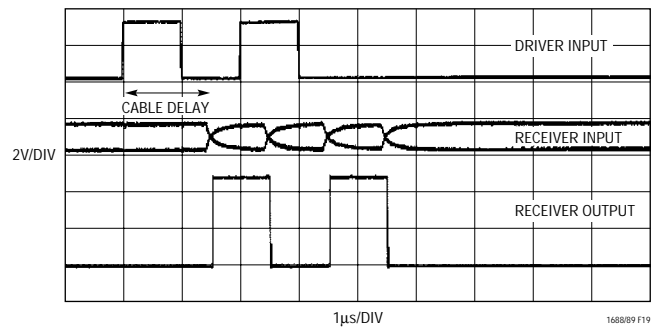

Figure 19. 1000 Feet, 1Mbps, LTC1518 Receiver

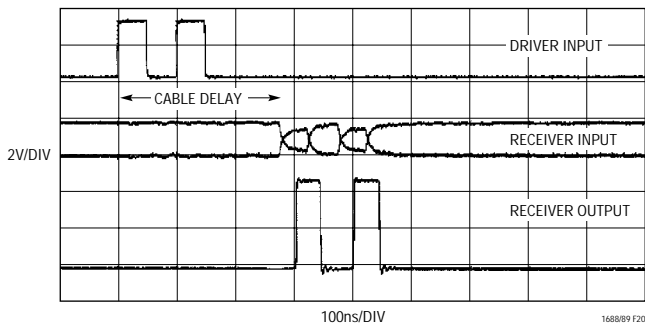

Figure 20. 200 Feet, 20Mbps, LTC1518 Receiver

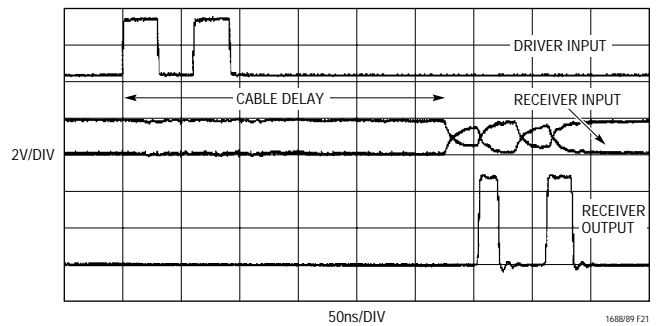

Figure 21. 200 Feet, 33Mbps, LTC1518 Receiver

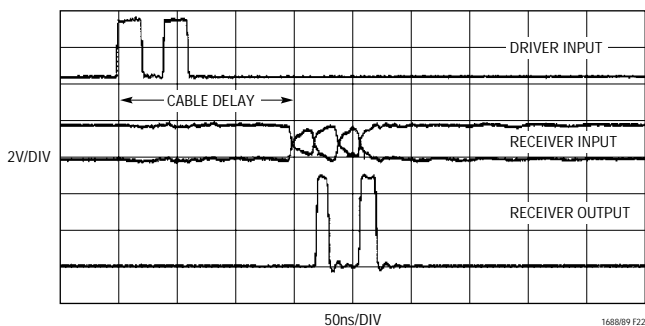

Figure 22. 100 Feet, 50Mbps, LTC1518 Receiver

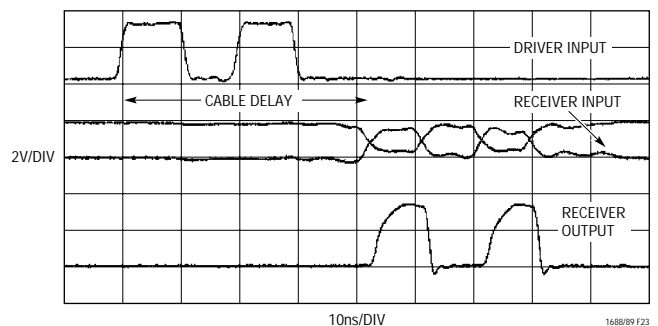
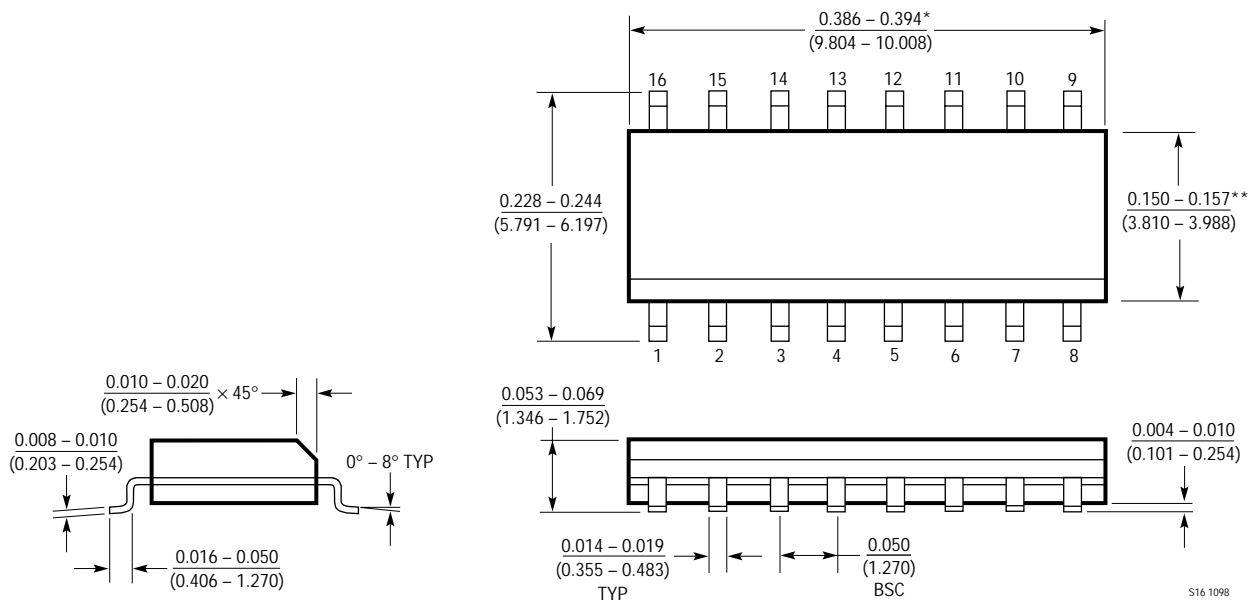

Figure 23. 25 Feet, 100Mbps, BRF2A Receiver

PACKAGE DESCRIPTION

Dimensions in inches (millimeters) unless otherwise noted.

S Package
16-Lead Plastic Small Outline (Narrow 0.150)
 (LTC DWG # 05-08-1610)



*DIMENSION DOES NOT INCLUDE MOLD FLASH. MOLD FLASH SHALL NOT EXCEED 0.006" (0.152mm) PER SIDE
 **DIMENSION DOES NOT INCLUDE INTERLEAD FLASH. INTERLEAD FLASH SHALL NOT EXCEED 0.010" (0.254mm) PER SIDE

S16 1098

RELATED PARTS

PART NUMBER	DESCRIPTION	COMMENTS
LTC486/LTC487	Low Power Quad RS485 Drivers	110µA Typ Supply Current, 10Mbps, -7V to 12V Common Mode Range
LT [®] 1394	7ns UltraFast Single Supply Comparator	6mA Typ Supply Current, Ground Sensing on Single Supply
LTC1518/LTC1519	High Speed, Precision Quad RS485 Receivers	52Mbps, Pin Compatible with LTC488/LTC489
LTC1520	High Speed, Precision Quad Differential Line Receiver	Single Supply, 18ns Propagation Delay, 100mV Threshold
LTC1685	High Speed, Precision RS485 Transceiver	52Mbps, Pin Compatible with LTC485
LTC1686/LTC1687	High Speed, Precision RS485 Full-Duplex Transceivers	52Mbps, Pin Compatible with LTC490/LTC491
LT1720	Dual 4.5ns UltraFast Single Supply Comparator	4mA per Comparator, Optimized for 3V or 5V Operation