T-1 3/4 (5 mm) Precision Optical Performance InGaN Bluish-Green LED Lamps

Technical Data



SunPower Series
HLMP-CE23
HLMP-CE24
HLMP-CE30
HLMP-CE31

Features

- **Smooth, Consistent Spatial Radiation Patterns**
- **High Luminous Output**
- **Choice of Three Minimum Luminous Intensities**
- **Viewing Angles: 23° and 30°**
- **Superior Resistance to Moisture**

Benefits

- **Viewing Angles Match Traffic Signal Requirements**
- **Superior Performance in Outdoor Environments**
- **Suitable for Autoinsertion onto PC Boards**

Applications

- **Traffic Signals**
- **Commercial Outdoor Signs**
- **Automotive Interior Lights**

Description

These high intensity bluish-green LEDs are based on InGaN material technology. InGaN is the most efficient and cost effective material for LEDs in the blue and green region of the spectrum. The 505 nm typical dominant wavelength matches international specifications for green traffic signals.

These LED lamps are untinted, nondiffused, T-1 3/4 packages incorporating second generation optics producing well defined spatial radiation patterns at specific viewing cone angles.

These lamps are made with an advanced optical grade epoxy, offering superior temperature and moisture resistance in outdoor signal and sign applications. The package epoxy contains both UV-a and UV-b inhibitors to reduce the effects of



long term exposure to direct sunlight.

These lamps are available in two viewing angle options and two package options to give the designer flexibility with optical design and device mounting.

Each part type includes three choices for minimum luminous intensity.

CAUTION: HLMP-CExx LEDs are Class 1 ESD sensitive. Please observe appropriate precautions during handling and processing. Refer to Hewlett-Packard Application Note AN-1142 for additional details.

Device Selection Guide

Part Number	Viewing Angle	Typical Intensity at 20 mA (mcd)	Stand Off
HLMP-CE23	23°	1500	No
HLMP-CE23-R0000	23°	2100	No
HLMP-CE23-S0000	23°	2300	No
HLMP-CE24	23°	1500	Yes
HLMP-CE24-R0000	23°	2100	Yes
HLMP-CE24-S0000	23°	2300	Yes
HLMP-CE30	30°	1150	No
HLMP-CE30-P0000	30°	1900	No
HLMP-CE30-Q0000	30°	2100	No
HLMP-CE31	30°	1150	Yes
HLMP-CE31-P0000	30°	1900	Yes
HLMP-CE31-Q0000	30°	2100	Yes

Package Dimensions

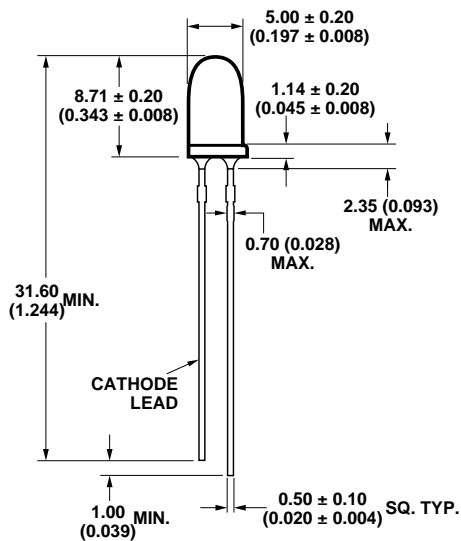

HLMP-CE23 and HLMP-CE30

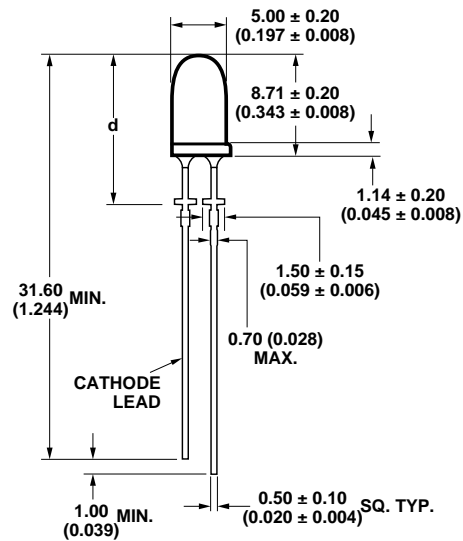

HLMP-CE24 and HLMP-CE31

HLMP-CE24	HLMP-CE31
$d = 12.42 \pm 0.25$ (0.489 ± 0.010)	$d = 11.96 \pm 0.25$ (0.471 ± 0.010)

Notes:

- Dimensions in mm.
- Tolerance ± 0.1 mm unless otherwise noted.

Absolute Maximum Ratings at $T_A = 25^\circ\text{C}$

Parameter	Value	Units
DC Forward Current ^[1]	30	mA
Peak Forward Current	100	mA
Average Forward Current	30	mA
Power Dissipation	120	mW
Reverse Voltage ($I_R = 100\ \mu\text{A}$)	5	V
LED Junction Temperature	100	$^\circ\text{C}$
Operating Temperature Range	-40 to +80	$^\circ\text{C}$
Storage Temperature Range	-40 to +100	$^\circ\text{C}$

Note:

- Derate linearly as shown in Figure 4 for temperatures above 50°C .

Optical Characteristics at $T_A = 25^\circ\text{C}$

Part Number	Luminous Intensity I_V ^[1] (mcd) at $I_F = 20\ \text{mA}$		Peak Wavelength λ_{PEAK} (nm) Typ.	Color, Dominant Wavelength λ_d ^[2] (nm) Typ.	Spectral Halfwidth $\Delta\lambda_{1/2}$ (nm)	Viewing Angle $2\theta_{1/2}$ Degrees ^[3] Typ.	Luminous Efficacy ^[4] η_V (lm/W)
	Min.	Typ.					
HLMP-CE23	1000	1500	502	505	35	23	350
HLMP-CE24	1000	1500	502	505	35	23	350
HLMP-CE23-R0000	1300	2100	502	505	35	23	350
HLMP-CE24-R0000	1300	2100	502	505	35	23	350
HLMP-CE23-S0000	1650	2300	502	505	35	23	350
HLMP-CE24-S0000	1650	2300	502	505	35	23	350
HLMP-CE30	590	1150	502	505	35	30	350
HLMP-CE31	590	1150	502	505	35	30	350
HLMP-CE30-P0000	765	1900	502	505	35	30	350
HLMP-CE31-P0000	765	1900	502	505	35	30	350
HLMP-CE30-Q0000	1000	2100	502	505	35	30	350
HLMP-CE31-Q0000	1000	2100	502	505	35	30	350

Notes:

- All InGaN LEDs represented here are IEC825 Class 2. See *Application Brief 1009* and *1015* for details.
- The dominant wavelength λ_d is derived from the CIE Chromaticity Diagram and represents the perceived color of the device.
- $\theta_{1/2}$ is the off-axis angle where the luminous intensity is 1/2 the peak intensity.
- Luminous efficacy is the ratio of luminous flux to radiant flux.

Electrical Characteristics at $T_A = 25^\circ\text{C}$

Forward Voltage V_F (Volts) at $I_F = 20\text{ mA}$ Typ. Max.		Reverse Breakdown V_R (Volts) at $I_R = 100\ \mu\text{A}$ Min.	Capacitance C (pF), $V_F = 0$, $f = 1\text{ MHz}$ Typ.	Thermal Resistance $R_{\theta\text{J-PIN}}$ ($^\circ\text{C/W}$)
3.5	4.0	10	40	240

Intensity Bin Limits (mcd at 20 mA)

Bin Name	Min.	Max.
N	680	880
P	880	1150
Q	1150	1500
R	1500	1900
S	1900	2500
T	2500	3200
U	3200	4200

Tolerance of each minimum and maximum = $\pm 15\%$.

Note:

- Bin categories are established for classification of products. Products may not be available in all bin categories. Please contact your Hewlett-Packard representative for information on currently available bins.

Color Bin Limits (nm at 20 mA)

Bin Name	Min.	Max.
1	490	495
2	495	500
3	500	505
4	505	510

Tolerance of each minimum and maximum = $\pm 2\text{ nm}$.

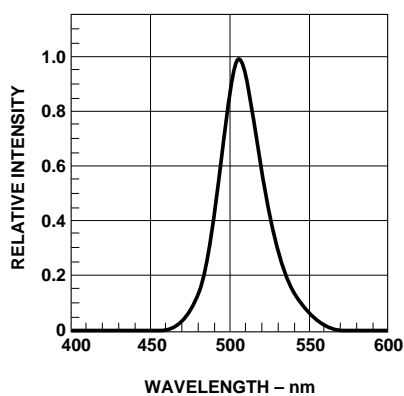

Figure 1. Relative Intensity vs. Wavelength.

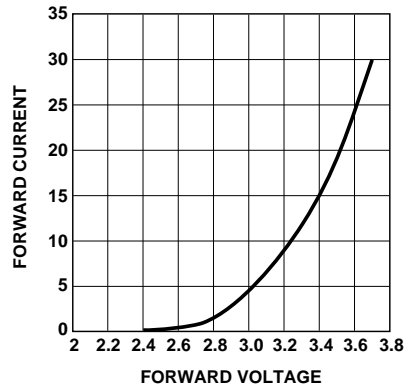

Figure 2. Forward Current vs. Forward Voltage.

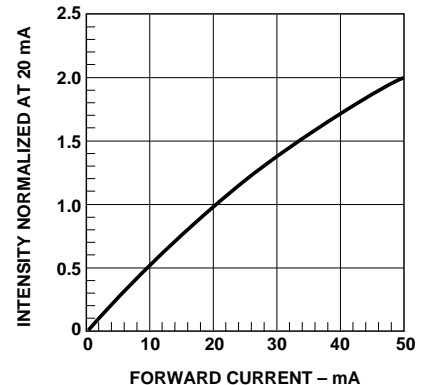

Figure 3. Relative Luminous Intensity vs. Forward Current.

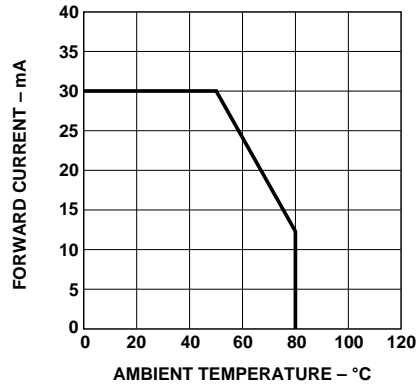

Figure 4. Maximum Forward Current vs. Ambient Temperature.

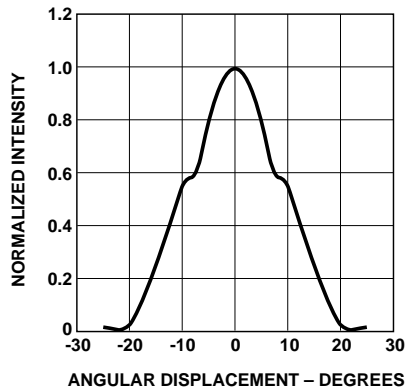

Figure 5. Spatial Radiation Pattern - 23° Lamp.

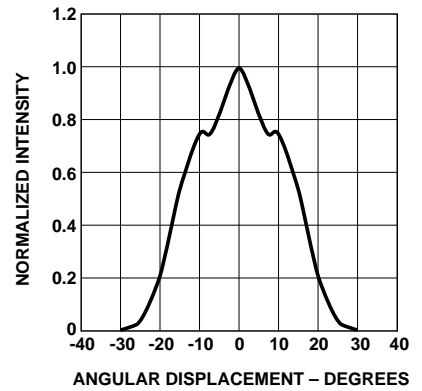

Figure 6. Spatial Radiation Pattern - 30° Lamp.

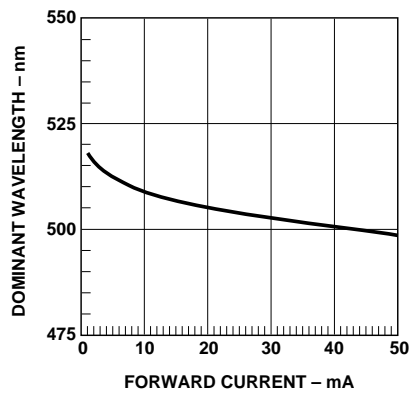

Figure 7. Color vs. Forward Current.

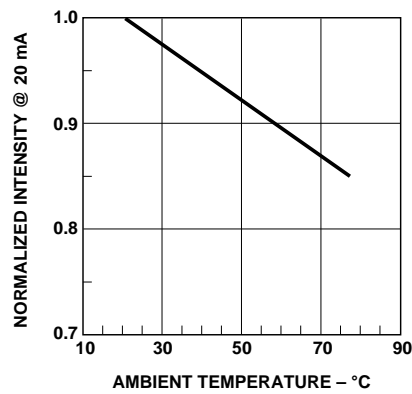

Figure 8. Normalized Intensity vs. Temperature.



www.hp.com/go/led_lamps

For technical assistance or the location of your nearest Hewlett-Packard sales office, distributor or representative call:

Americas/Canada: 1-800-235-0312 or 408-654-8675

Far East/Australasia: Call your local HP sales office.

Japan: (81 3) 3335-8152

Europe: Call your local HP sales office.

Data subject to change.

Copyright © 1998 Hewlett-Packard Co.

Printed in U.S.A. 5966-4980E (5/98)