

DELPHI SERIES



FEATURES

- ♦ High Efficiency:
92% @ 12Vin, 5V/40A out
- ♦ Voltage and resistor-based trim
- ♦ No minimum load required
- ♦ Output voltage programmable from 0.9Vdc to 5.0Vdc via external resistors
- ♦ Fixed frequency operation
- ♦ Input UVLO, output OVP, OTP, OCP, SCP
- ♦ Remote ON/OFF (default: positive)
- ♦ Power good output signal
- ♦ Output voltage sense
- ♦ ISO 9001, TL 9000, ISO 14001, QS 9000, OHSAS 18001 certified manufacturing facility
- ♦ UL/cUL 60950 (US & Canada) Recognized, and TUV (EN60950) Certified
- ♦ CE mark meets 73/23/EEC and 93/68/EEC directives

Delphi NC40 Series Non-Isolated Point of Load DC/DC Power Modules: 12Vin, 0.9V-5Vout, 40A

The Delphi NC40 Series, 12V input, single output, non-isolated point of load DC/DC converters are the latest offering from a world leader in power systems technology and manufacturing — Delta Electronics, Inc. The NC40 series operates from a 12V nominal input, provides up to 40A of power in a vertical or horizontal mounted through-hole package and the output can be resistor- or voltage-trimmed from 0.9Vdc to 5.0Vdc. NC40 series has built-in current sharing control and multiple NC30/NC40 series modules could be paralleled together to provide even higher output currents. NC40 series provides a very cost effective point of load solution. With creative design technology and optimization of component placement, these converters possess outstanding electrical and thermal performance, as well as extremely high reliability under highly stressful operating conditions.

OPTIONS

- ♦ Vertical or horizontal versions
- ♦ Negative On/Off logic

APPLICATIONS

- ♦ DataCom
- ♦ Distributed power architectures
- ♦ Servers and workstations
- ♦ LAN/WAN applications
- ♦ Data processing applications

DATASHEET
DS_NC12S40A_02072007

Delta Electronics, Inc.

TECHNICAL SPECIFICATIONS

($T_A=25^{\circ}\text{C}$, airflow rate=400LFM, $V_{in}=12\text{Vdc}$, nominal V_{out} unless otherwise noted)

PARAMETER	NOTES and CONDITIONS	NC12S0A0V40			
		Min.	Typ.	Max.	Units
ABSOLUTE MAXIMUM RATINGS					
Input Voltage				14	Vdc
Operating Temperature		0		50	$^{\circ}\text{C}$
Storage Temperature		-40		125	$^{\circ}\text{C}$
Input/Output Isolation Voltage	Non-isolated		NA		V
INPUT CHARACTERISTICS					
Operating Input Voltage		10.2	12	13.8	V
Input Under-Voltage Lockout					
Turn-On Voltage Threshold			9.0		V
Turn-Off Voltage Threshold			8.3		V
Lockout Hysteresis Voltage			0.7		V
Maximum Input Current	100% Load, 10.2 V_{in} , 5 V_{out}			23	A
No-Load Input Current			160		mA
Off Converter Input Current			40		mA
Input Reflected-Ripple Current	Refer to Figure 35		150		mA
Input Voltage Ripple Rejection	120 Hz		55		dB
Output Short-Circuit Input Current				1	A
OUTPUT CHARACTERISTICS					
Output Voltage Adjustment Range		0.9		5.0	V
Output Voltage Set Point	$V_{in}=12\text{V}$, $I_o=I_{o,max}$, 1% trim resistors	-3.0		+3.0	%
Output Voltage Regulation					
Over Load	$I_o=I_{o,min}$ to $I_{o,max}$	-1.0		+1.0	%
Over Line	$V_{in}=V_{in,min}$ to $V_{in,max}$	-0.2		+0.2	%
Output Voltage Ripple and Noise	5Hz to 20MHz bandwidth				
Peak-to-Peak	Full Load, 1 μF ceramic, 10 μF tantalum			50	mV
RMS	Full Load, 1 μF ceramic, 10 μF tantalum			15	mV
Output Current Range		0		40	A
Output Voltage Over-shoot at Start-up	$V_{in}=12\text{V}$, Turn ON			1	%
Output Voltage Under-shoot at Power-Off	$V_{in}=12\text{V}$, Turn OFF			100	mV
Output DC Current-Limit Inception		62			A
DYNAMIC CHARACTERISTICS					
Out Dynamic Load Response	12 V_{in} , 10 μF Tan & 1 μF Ceramic load cap, 10A/ μs				
Positive Step Change in Output Current	50% $I_{o,max}$ to 75% $I_{o,max}$		75		mV
Negative Step Change in Output Current	75% $I_{o,max}$ to 50% $I_{o,max}$		75		mV
Settling Time	Settling to be within regulation band (+/- 3.0%)			150	μs
Turn-On Transient	$I_o=I_{o,max}$				
Start-Up Time, From On/Off Control	$V_{in}=12\text{V}$, $V_o=10\%$ of $V_{o,set}$			10	ms
Start-Up Time, From Input	$V_o=10\%$ of $V_{o,set}$			30	ms
Minimum Output Startup Capacitive Load	Ex: Three OSCON 6.3V/680 μF (ESR 13m Ω max each)	2040			μF
Maximum Output Startup Capacitive Load	Full load			6120	μF
Minimum Input Capacitance	Ex: Two OSCON 16V/270 μF (ESR 18m Ω max each)	540			μF
EFFICIENCY					
$V_o=0.9\text{V}$	$V_{in}=12\text{V}$, $I_o=30\text{A}$		75		%
$V_o=1.2\text{V}$	$V_{in}=12\text{V}$, $I_o=30\text{A}$		80		%
$V_o=1.5\text{V}$	$V_{in}=12\text{V}$, $I_o=30\text{A}$		83		%
$V_o=1.8\text{V}$	$V_{in}=12\text{V}$, $I_o=30\text{A}$		85		%
$V_o=2.5\text{V}$	$V_{in}=12\text{V}$, $I_o=30\text{A}$		88		%
$V_o=3.3\text{V}$	$V_{in}=12\text{V}$, $I_o=30\text{A}$		90		%
$V_o=5.0\text{V}$	$V_{in}=12\text{V}$, $I_o=30\text{A}$		92		%
FEATURE CHARACTERISTICS					
Switching Frequency			300		KHz
ON/OFF Control	Positive logic (internally pulled high)				
Logic High	Module On (or leave the pin open)	2.4		5.5	V
Logic Low	Module Off	0		0.8	V
Remote Sense Range				400	mV
GENERAL SPECIFICATIONS					
MTBF	Telcordia SR-332 Issue1 Method1 Case3 at 50C		2.5		M hours
Weight			37		grams
Over-Temperature Shutdown	Auto restart, refer to Figs 36 & 41 for the measuring point		130		$^{\circ}\text{C}$



ELECTRICAL CHARACTERISTICS CURVES

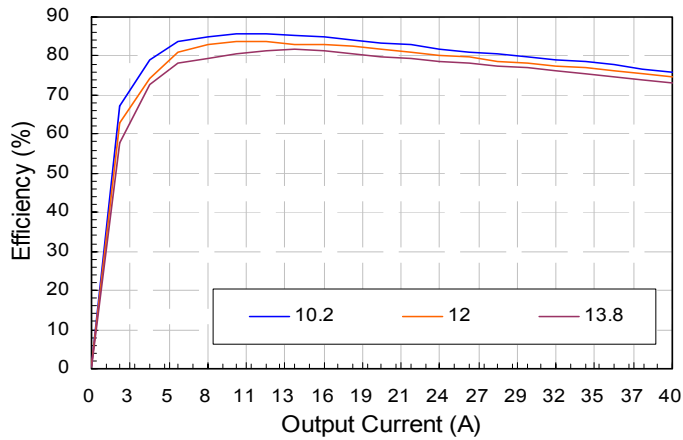

Figure 1: Converter efficiency vs. output current (0.9V output voltage)

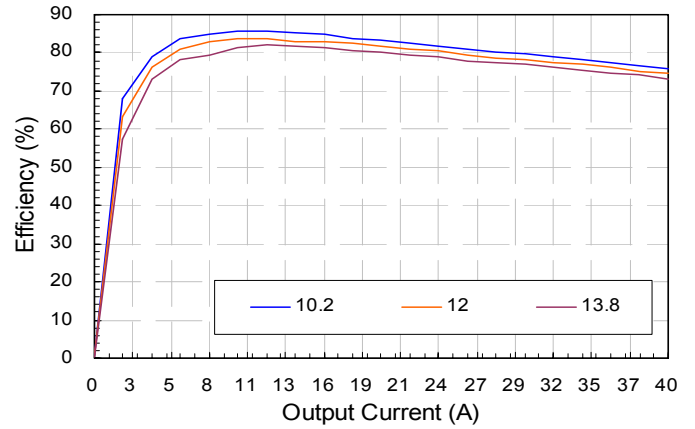

Figure 2: Converter efficiency vs. output current (1.2V output voltage)

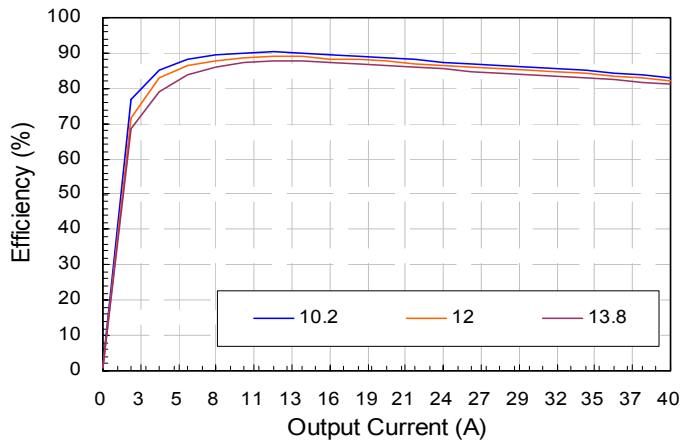

Figure 3: Converter efficiency vs. output current (1.5V output voltage)

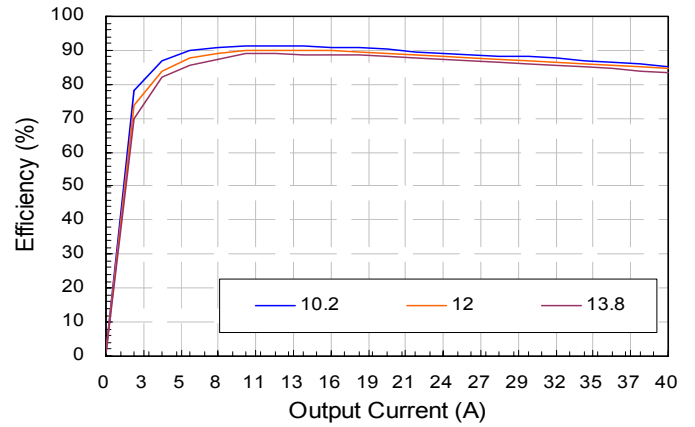

Figure 4: Converter efficiency vs. output current (1.8V output voltage)

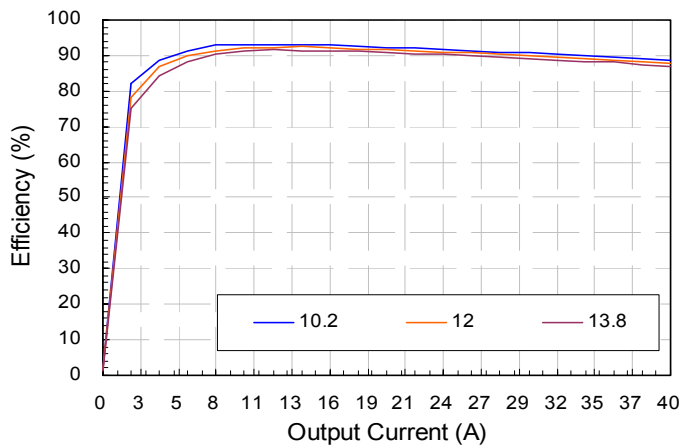

Figure 5: Converter efficiency vs. output current (2.5V output voltage)

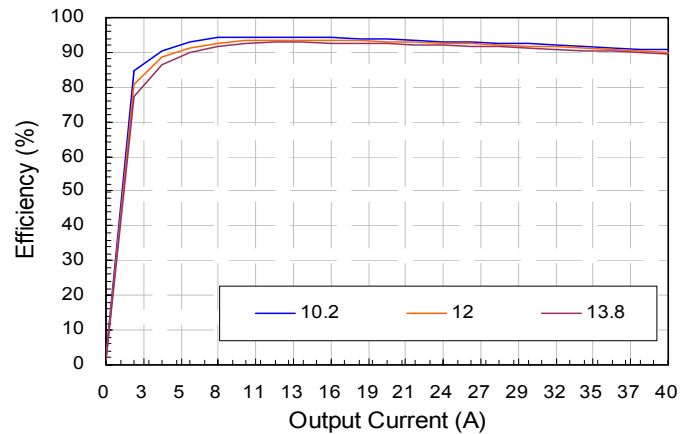

Figure 6: Converter efficiency vs. output current (3.3V output voltage)



ELECTRICAL CHARACTERISTICS CURVES (CON.)

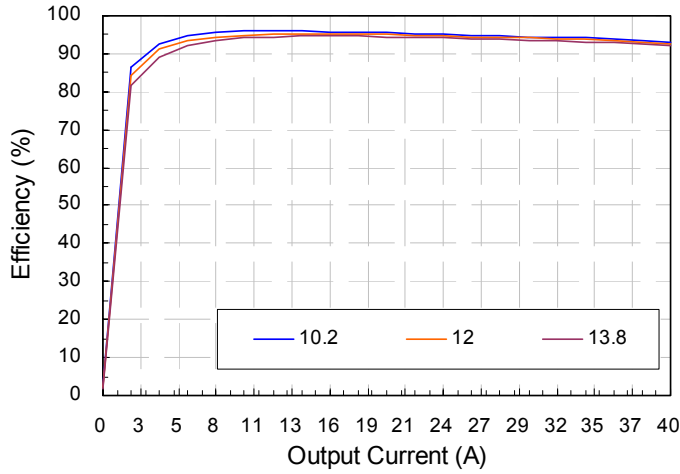

Figure 7: Converter efficiency vs. output current (5V output voltage)

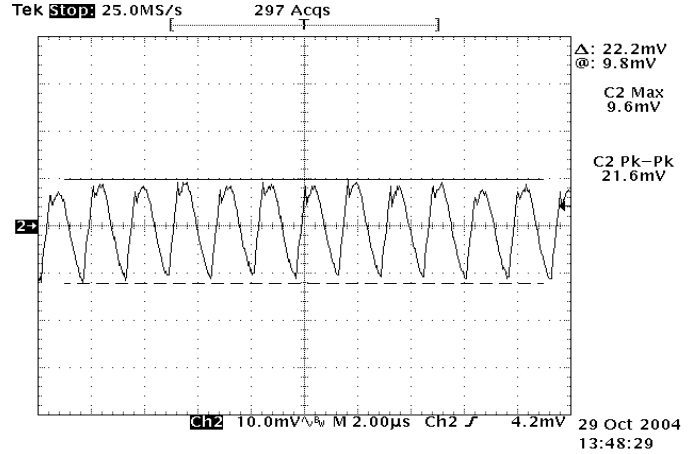

Figure 8: Output ripple & noise at 12Vin, 0.9V/40A out

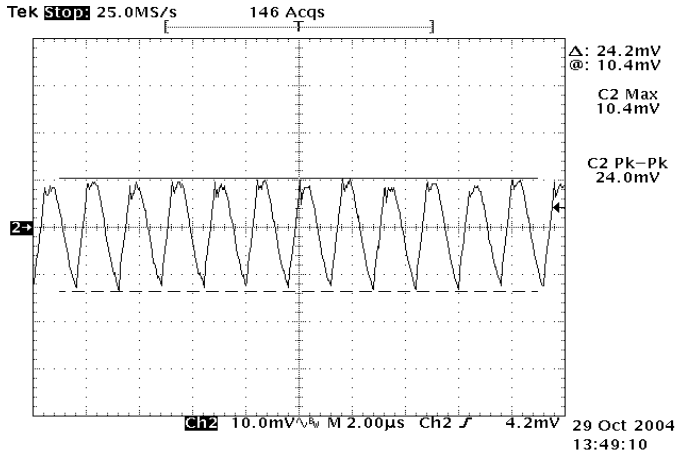

Figure 9: Output ripple & noise at 12Vin, 1.2V/40A out

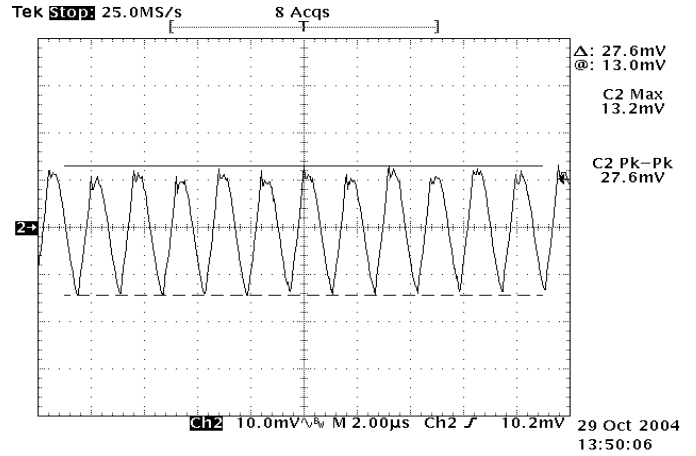

Figure 10: Output ripple & noise at 12Vin, 1.5V/40A out

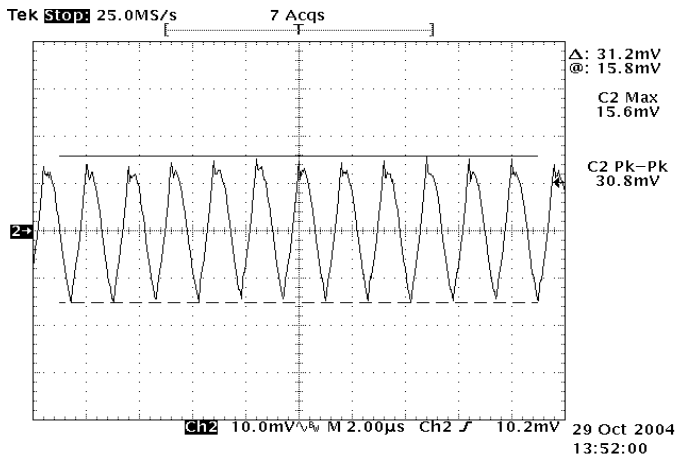

Figure 11: Output ripple & noise at 12Vin, 1.8V/40A out

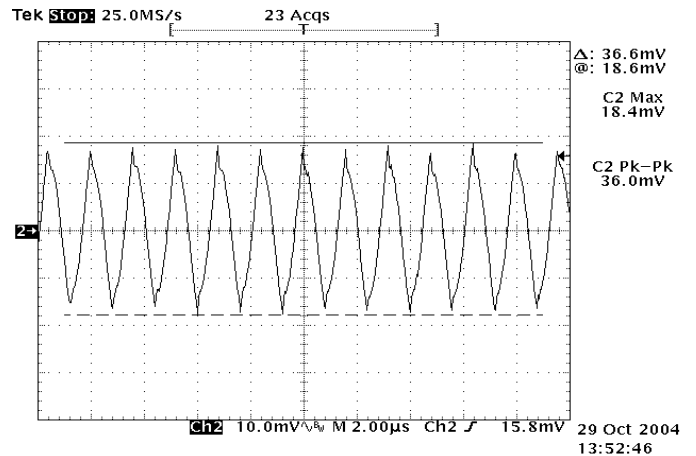

Figure 12: Output ripple & noise at 12Vin, 2.5V/40A out



ELECTRICAL CHARACTERISTICS CURVES (CON.)

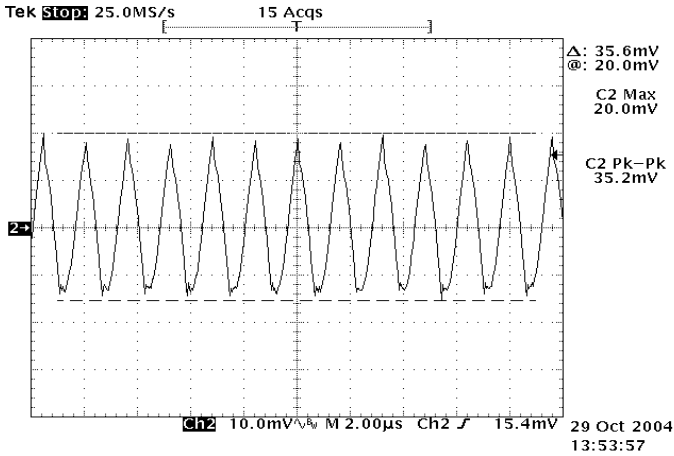

Figure 13: Output ripple & noise at 12Vin, 3.3V/40A out

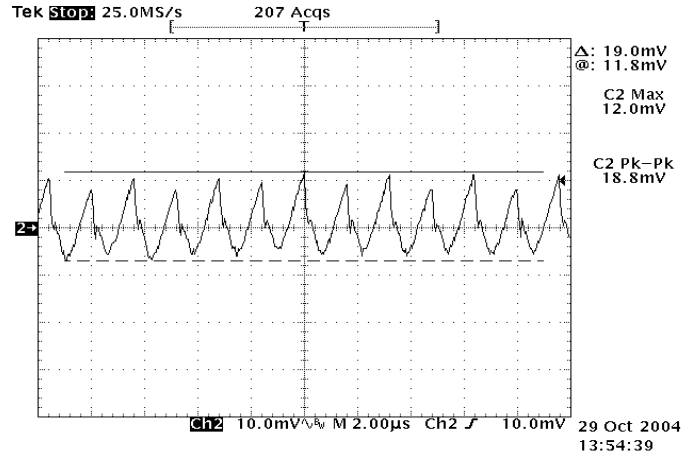

Figure 14: Output ripple & noise at 12Vin, 5V/40A out

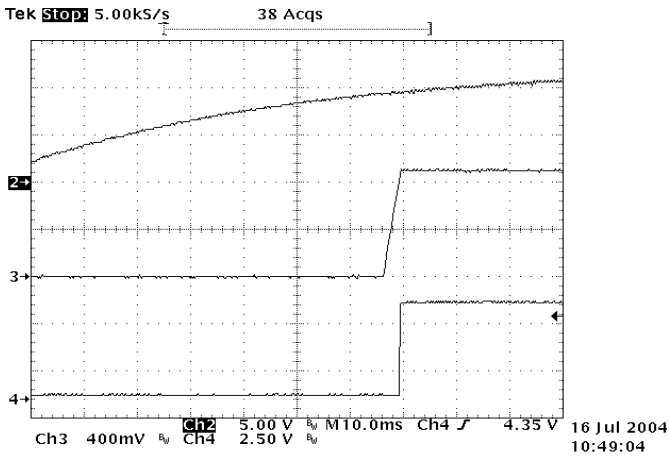

Figure 15: Turn on delay time at 12Vin, 0.9V/40A out
Ch2:Vin Ch3:Vout Ch4:PWRGD

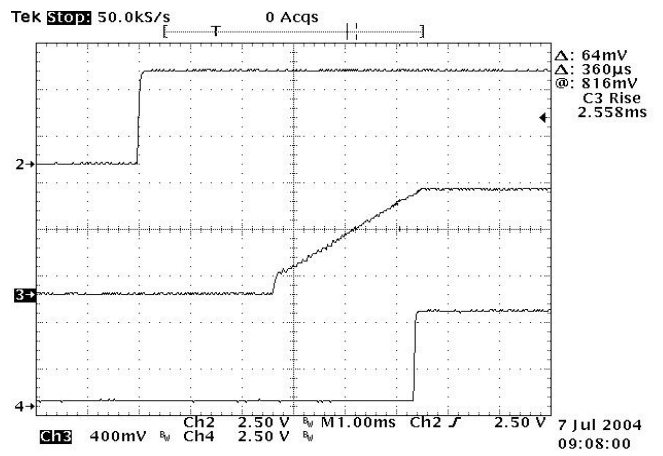

Figure 16: Turn on delay time Remote On/Off, 0.9V/40A out
Ch2:ENABLE Ch3:Vout Ch4:PWRGD

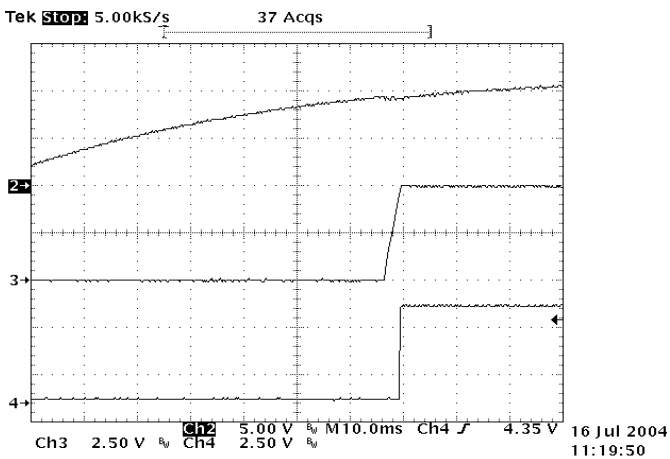

Figure 17: Turn on delay time at 12Vin, 5V/40A out
Ch2:Vin Ch3:Vout Ch4:PWRGD

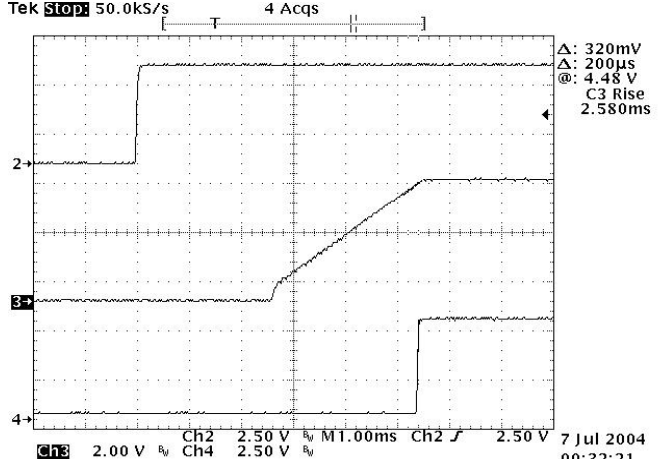

Figure 18: Turn on delay time Remote On/Off, 5V/40A out
Ch2: ENABLE Ch3:Vout Ch4:PWRGD



ELECTRICAL CHARACTERISTICS CURVES (CON.)

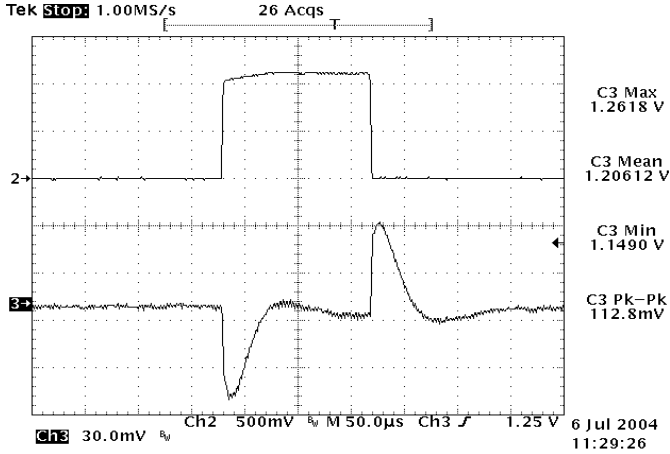

Figure 19: Typical transient response to step load change at 10A/μS from 50% to 75% and 75% to 50% of I_o, max at 12V_{in}, 1.2V out

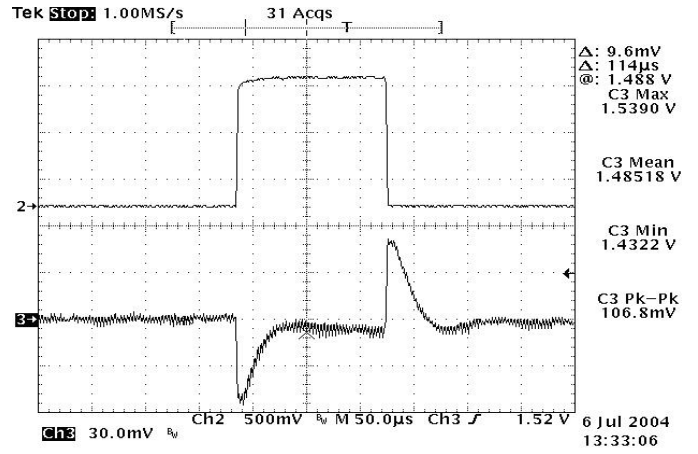

Figure 20: Typical transient response to step load change at 10A/μS from 50% to 75% and 75% to 50% of I_o, max at 12V_{in}, 1.5V out

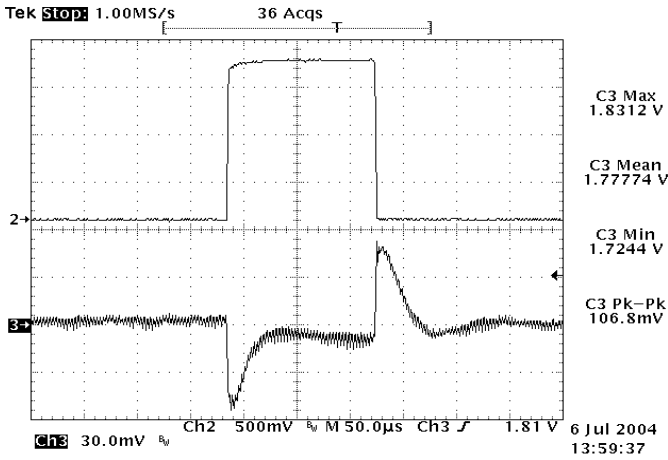

Figure 21: Typical transient response to step load change at 10A/μS from 50% to 75% and 75% to 50% of I_o, max at 12V_{in}, 1.8V out

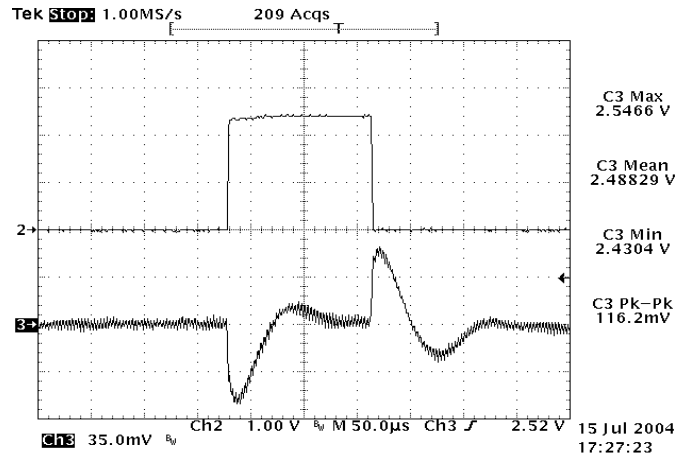

Figure 22: Typical transient response to step load change at 10A/μS from 50% to 75% and 75% to 50% of I_o, max at 12V_{in}, 2.5V out

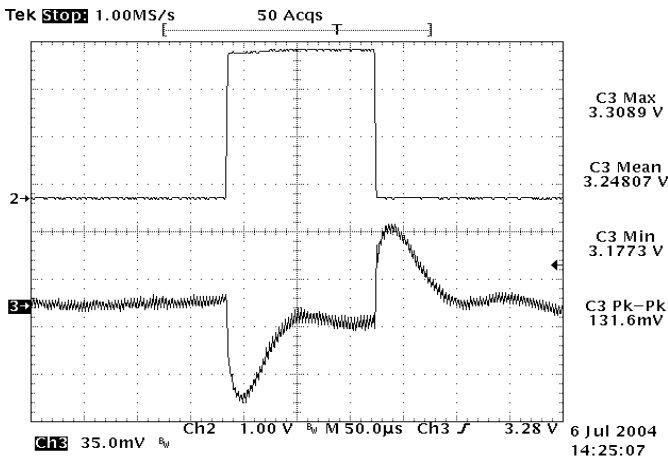

Figure 23: Typical transient response to step load change at 10A/μS from 50% to 75% and 75% to 50% of I_o, max at 12V_{in}, 3.3V out

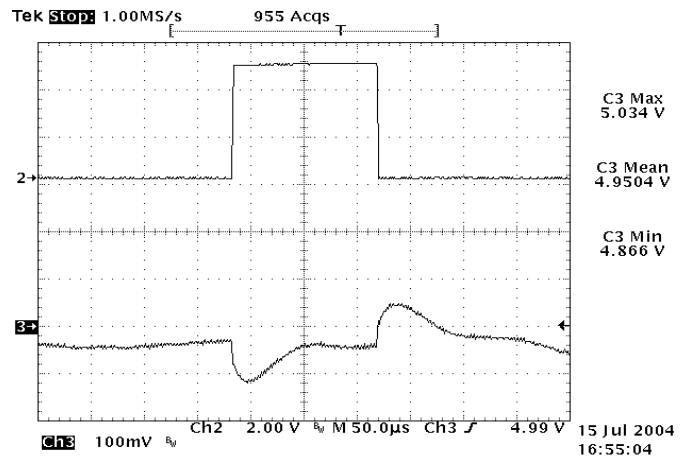

Figure 24: Typical transient response to step load change at 10A/μS from 50% to 75% and 75% to 50% of I_o, max at 12V_{in}, 5.0V out

DESIGN CONSIDERATIONS

The NC40 is designed using two-phase synchronous buck topology. Block diagram of the converter is shown in Figure 25. The output can be trimmed in the range of 0.9Vdc to 5.0Vdc by a resistor from trim pin to ground. A remote sense function is provided and it is able to compensate for a drop from the output of converter to point of load.

The converter can be turned ON/OFF by remote control. Positive on/off (ENABLE pin) logic implies that the converter DC output is enabled when this signal is driven high (greater than 2.4V) or floating and disabled when the signal is driven low (below 0.8V). Negative on/off logic is optional and could also be ordered.

The converter provides an open collector signal called Power Good. The power good signal is pulled low when output is not within $\pm 10\%$ of Vout or Enable is OFF.

The converter can protect itself by entering hiccup mode against over current and short circuit condition. Also, the converter will shut down when an over voltage protection is detected.

The converter has an over temperature protection which can protect itself by shutting down for an over temperature event. There is a thermal hysteresis of typically 30°C

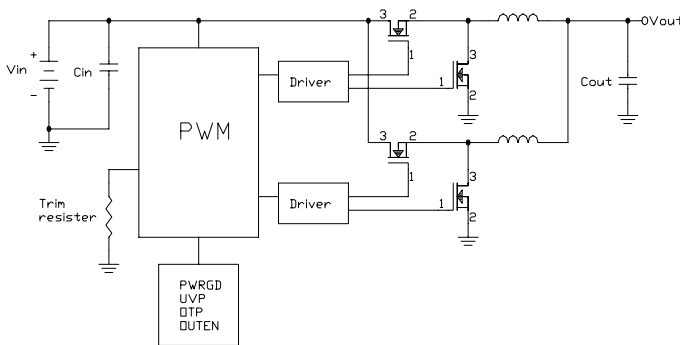

Figure 25: Block Diagram

Safety Considerations

It is recommended that the user to provide two 12A very fast-acting type fuses (Little fuse R451 012) in parallel in the input line for safety.

FEATURES DESCRIPTIONS

ENABLE (On/Off)

The ENABLE (on/off) input allows external circuitry to put the NC converter into a low power dissipation (sleep) mode. Positive (active-high) ENABLE is available as standard.

Positive ENABLE (active-high) units of the NC series are turned on if the ENABLE pin is high or floating. Pulling the pin low will turn off the unit. With the active high function, the output is guaranteed to turn on if the ENABLE pin is driven above 2.4V. The output will turn off if the ENABLE pin voltage is pulled below .8V.

The ENABLE input can be driven in a variety of ways as shown in Figures 26, 27 and 28. If the ENABLE signal comes from the primary side of the circuit, the ENABLE can be driven through either a bipolar signal transistor (Figure 26) or a logic gate (Figure 27). If the enable signal comes from the secondary side, then an opto-coupler or other isolation devices must be used to bring the signal across the voltage isolation (please see Figure 28).

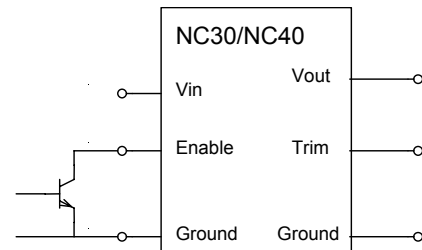

Figure 26: Enable Input drive circuit for NC series

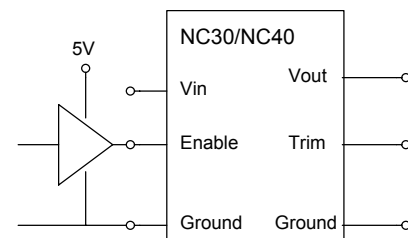

Figure 27: Enable input drive circuit using logic gate.

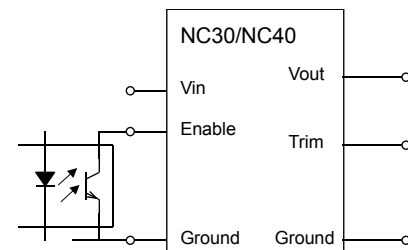

Figure 28: Enable input drive circuit example with isolation.

FEATURES DESCRIPTIONS (CON.)

Input Under-Voltage Lockout

The input under-voltage lockout prevents the converter from being damaged while operating when the input voltage is too low. The lockout occurs between 7.7V to 8.6V.

Over-Current and Short-Circuit Protection

The NC series modules have non-latching over-current and short-circuit protection circuitry. When over current condition occurs, the module goes into the non-latching hiccup mode. When the over-current condition is removed, the module will resume normal operation.

An over current condition is detected by measuring the voltage drop across the high-side MOSFET. The voltage drop across the MOSFET is also a function of the MOSFET's $R_{ds(on)}$. $R_{ds(on)}$ is affected by temperature, therefore ambient temperature will affect the current limit inception point.

The unit will not be damaged in an over current condition because it will be protected by the over temperature protection.

Remote Sense

The NC30/NC40 provide V_o remote sensing to achieve proper regulation at the load points and reduce effects of distribution losses on output line. In the event of an open remote sense line, the module shall maintain local sense regulation through an internal resistor. The module shall correct for a total of 0.4V of loss. The remote sense connects as shown in Figures 29.

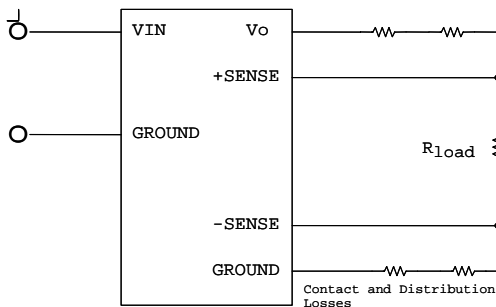

Figure 29: Circuit configuration for remote sense

Over Temperature Protection (OTP)

To provide additional over-temperature protection in a fault condition, the unit is equipped with a non-latching thermal shutdown circuit. The shutdown circuit engages when the temperature of monitored component exceeds approximately 130°C . The unit will cycle on and off while the fault condition exists. The unit will recover from shutdown when the cause of the over temperature condition is removed.

Over Voltage Protection (OVP)

The converter will shut down when an output over voltage is detected. Once the OVP condition is detected, the controller will stop all PWM outputs and will turn on low-side MOSFET driver to prevent any damage to load.

Current Sharing (optional)

The parallel operation of multiple converters is available with the NC30/NC40 (option code B). The converters will current share to be within $\pm 10\%$ of each other. In addition to connect the I-Share pin together for the current sharing operation, the remote sense lines of the paralleled units must be connected at the same point for proper operation. Also, units are intended to be turned on/enabled at the same time. Hot plugging is not recommended. The current sharing diagram show in Figure 30.

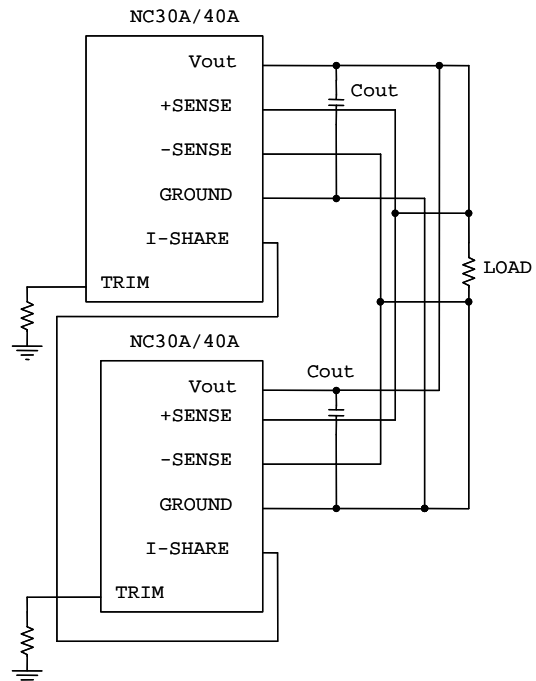

Figure 30: NC30/NC40 Current Sharing Diagram

FEATURES DESCRIPTIONS (CON.)

Output Voltage Programming

The output voltage of the NC series is trimmable by connecting an external resistor between the trim pin and output ground as shown Figure 31 and the typical trim resistor values are shown in Figure 32. The output can also be set by an external voltage connected to trim pin as shown in Figure 32.

The NC30A/40A module has a trim range of 0.9V to 5.0V. A plot of trim behavior is shown in Figure 33

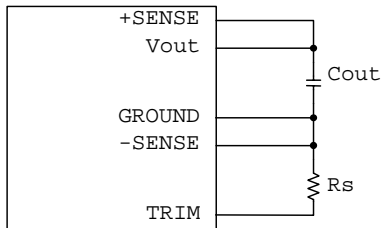

Figure 31: Trimming Output Voltage

The NC30/NC40 modules have a trim range of 0.9V to 5.0V. The trim resistor equation for the them is :

$$R_s (k\Omega) = \frac{12.69 - V_{out}}{V_{out} - 0.9}$$

Vout is the desired voltage setpoint,
Rs is the trim resistance between TRIM and Ground,
Rs values should not be less than 1.8 kΩ

Output Voltage	Rs(Ω)
+0.9 V	OPEN
+1.2 V	38.3K
+1.5 V	18.7K
+1.8 V	12.1K
+2.5 V	6.34K
+3.3 V	3.92K
+5.0 V	1.87K

Figure 32: Typical trim resistor values

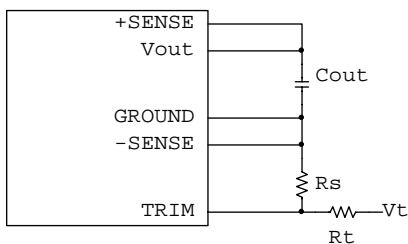

Figure 33: Output voltage trim with voltage source

To use voltage trim, the trim equation for the NC30 is (please refer to Fig. 33) :

$$R_t(k\Omega) = \frac{R_s(13.1V_t + V_{out} - 12.69)}{0.9R_s - V_{out}(R_s + 1) + 12.69}$$

Vout is the desired output voltage

Vt is the external trim voltage

Rs is the resistance between Trim and Ground (in KΩ)

Rt is the resistor to be defined with the trim voltage (in KΩ)

Below is an example about using this voltage trim equation :

Example :

If Vt = 1.25V, desired Vout = 2.5V and Rs = 1 kΩ

$$R_t(k\Omega) = \frac{R_s(13.1V_t + V_{out} - 12.69)}{0.9R_s - V_{out}(R_s + 1) + 12.69} = 0.72k\Omega$$

Power Good

The converter provides an open collector signal called Power Good. This output pin uses positive logic and is open collector. This power good output is able to sink 5mA and set high when the output is within $\pm 10\%$ of output set point. The power good signal is pulled low when output is not within $\pm 10\%$ of Vout or Enable is OFF.

Output Capacitance

There is no output capacitor on the NC series modules. Hence, an external output capacitor is required for stable operation. For NC40 modules, two external 6.3V/680μF output low ESR capacitors in parallel (for example, OSCON) are required for stable operation.

It is important to places these low ESR capacitors as close to the load as possible in order to get improved dynamic response and better voltage regulation, especially when the load current is large. Several of these low ESR capacitors could be used together to further lower the ESR.

Please refer to individual datasheet for the maximum allowed start-up load capacitance for each NC series as it is varied between series.

FEATURES DESCRIPTIONS (CON.)

Voltage Margining

Output voltage margining can be implemented in the NC30/NC40 modules by connecting a resistor, $R_{margin-up}$, from the Trim pin to the ground pin for margining up the output voltage. Also, the output voltage can be adjusted lower by connecting a resistor, $R_{margin-down}$, from the Trim pin to the output pin. Figure 34 shows the circuit configuration for output voltage margining adjustment.

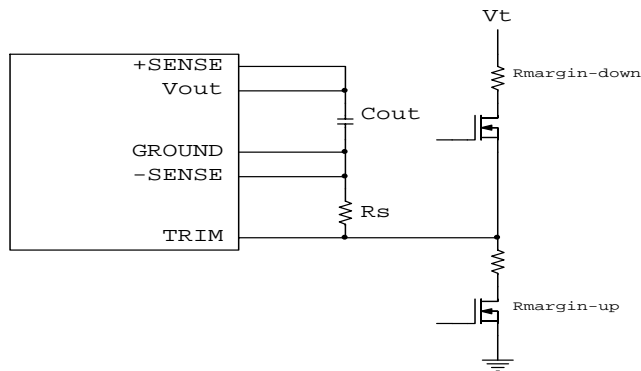
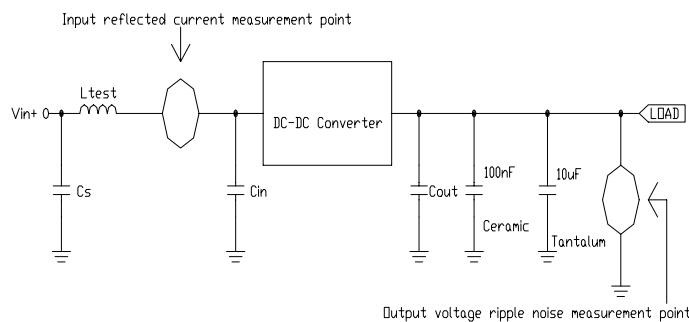

Figure 34: Circuit configuration for output voltage margining

Reflected Ripple Current and Output Ripple and Noise Measurement

The measurement set-up outlined in Figure 35 has been used for both input reflected/ terminal ripple current and output voltage ripple and noise measurements on NC series converters.



$$C_s = 270\mu F * 1 \quad L_{test} = 1.4\mu H \quad C_{in} = 270\mu F * 2 \quad C_{out} = 680\mu F * 3$$

Figure 35: Input reflected ripple/ capacitor ripple current and output voltage ripple and noise measurement setup for NC40

THERMAL CONSIDERATION

Thermal management is an important part of the system design. To ensure proper, reliable operation, sufficient cooling of the power module is needed over the entire temperature range of the module. Convection cooling is usually the dominant mode of heat transfer.

Hence, the choice of equipment to characterize the thermal performance of the power module is a wind tunnel.

Thermal Testing Setup

Delta's DC/DC power modules are characterized in heated vertical wind tunnels that simulate the thermal environments encountered in most electronics equipment. This type of equipment commonly uses vertically mounted circuit cards in cabinet racks in which the power modules are mounted.

The following figure shows the wind tunnel characterization setup. The power module is mounted on a test PWB and is vertically positioned within the wind tunnel.

Thermal Derating

Heat can be removed by increasing airflow over the module. To enhance system reliability, the power module should always be operated below the maximum operating temperature. If the temperature exceeds the maximum module temperature, reliability of the unit may be affected.

The maximum acceptable temperature measured at the thermal reference point is 125°C. This is shown in Figure 36 & 41.



THERMAL CURVES (NC12S0A0V40)

Test Section for NC12S0A0V40

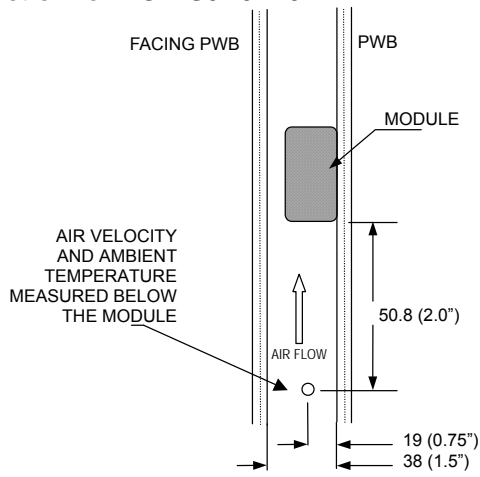

Note: Wind Tunnel Test Setup Figure Dimensions are in millimeters and (Inches)

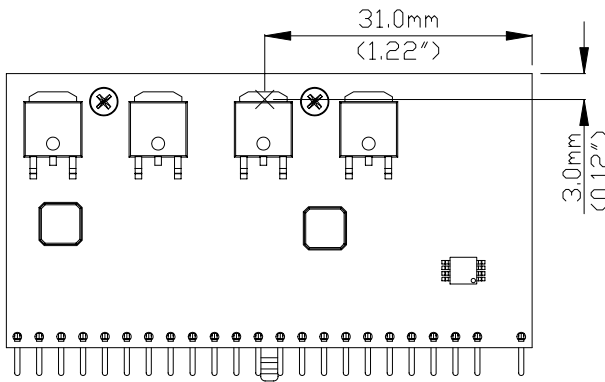

Figure 36: Temperature measurement location
* The allowed maximum hot spot temperature is defined at 125°C

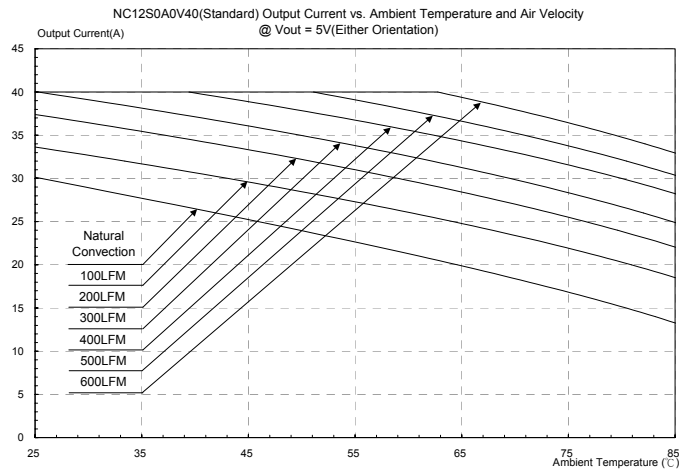

Figure 37: Output current vs. ambient temperature and air velocity @ Vout=5V(Either Orientation)

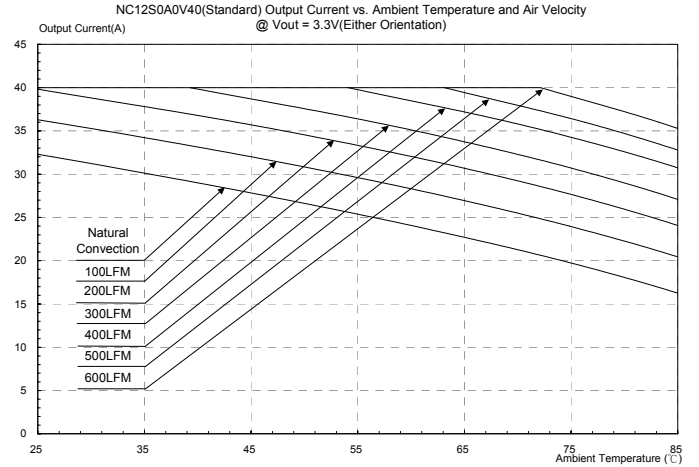

Figure 38: Output current vs. ambient temperature and air velocity @ Vout=3.3V(Either Orientation)

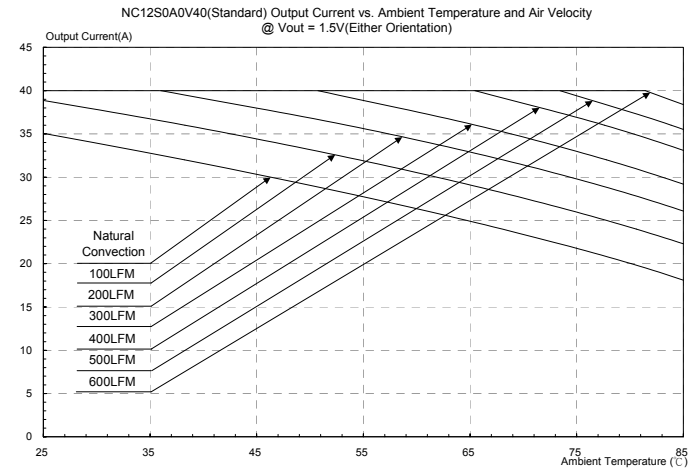

Figure 39: Output current vs. ambient temperature and air velocity @ Vout=1.5V(Either Orientation)

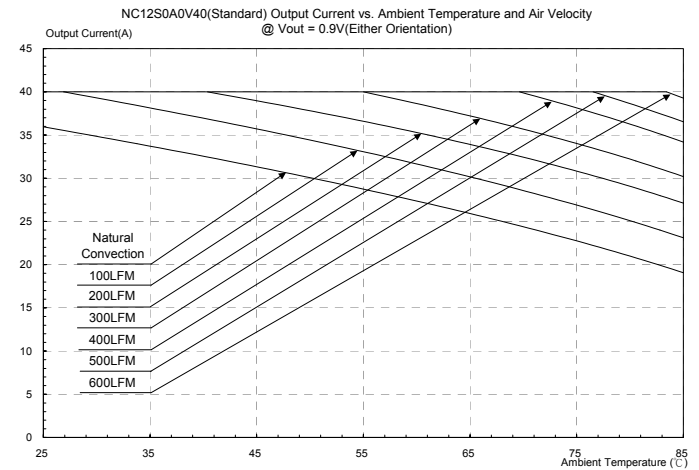
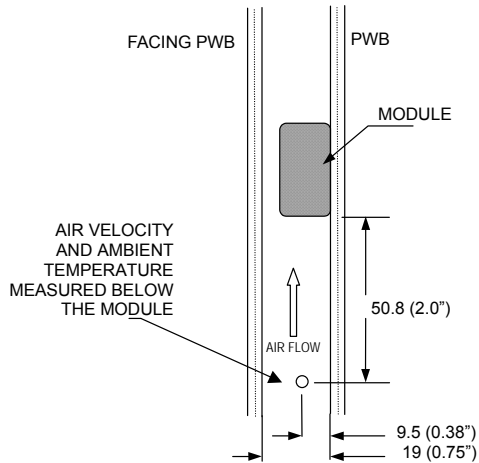

Figure 40: Output current vs. ambient temperature and air velocity @ Vout=0.9V(Either Orientation)

THERMAL CURVES (NC12S0A0H40)

Test Section for NC12S0A0H40



Note: Wind Tunnel Test Setup Figure Dimensions are in millimeters and (Inches)

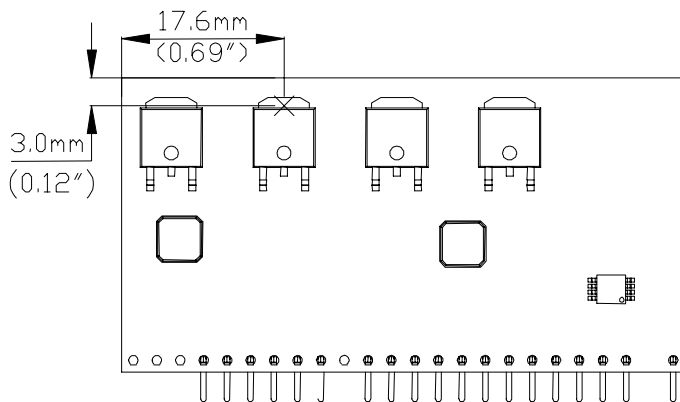

Figure 41: Temperature measurement location
* The allowed maximum hot spot temperature is defined at 125°C

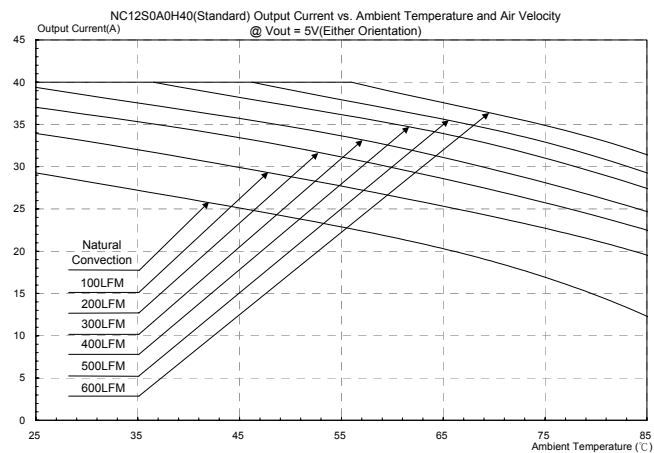

Figure 42: Output current vs. ambient temperature and air velocity @ Vout=5V(Either Orientation)

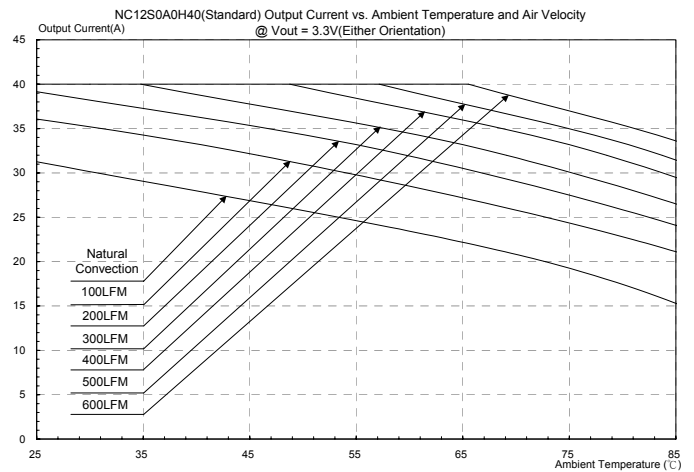

Figure 43: Output current vs. ambient temperature and air velocity @ Vout=3.3V(Either Orientation)

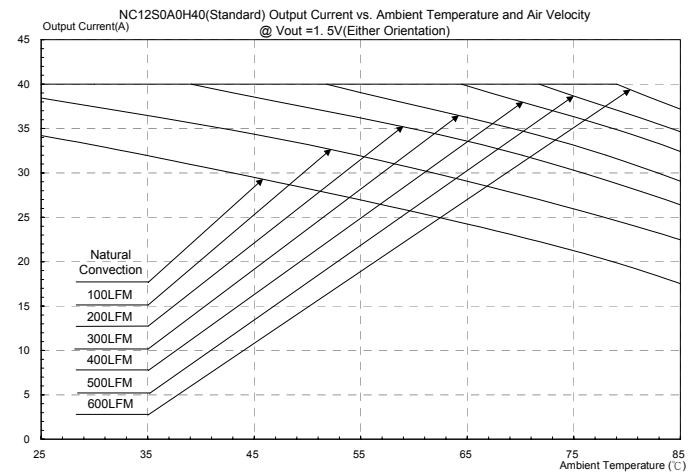

Figure 44: Output current vs. ambient temperature and air velocity @ Vout=1.5V(Either Orientation)

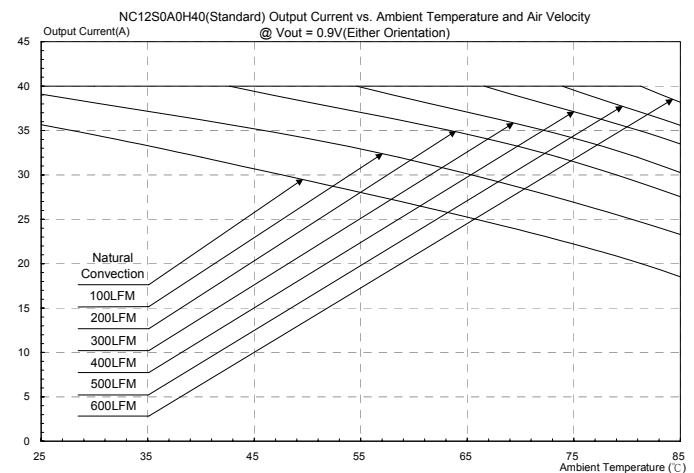
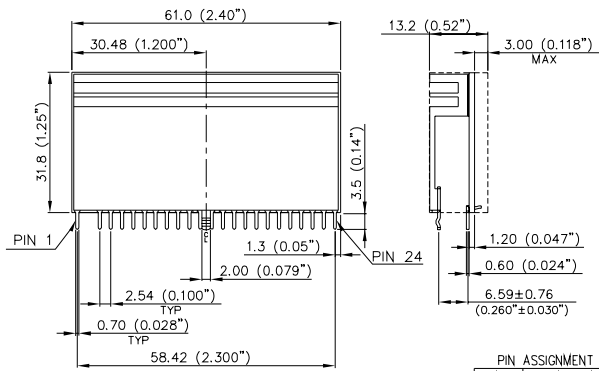

Figure 45: Output current vs. ambient temperature and air velocity @ Vout=0.9V(Either Orientation)

MECHANICAL DRAWING

VERTICAL



SUGGESTED PCB LAYOUT

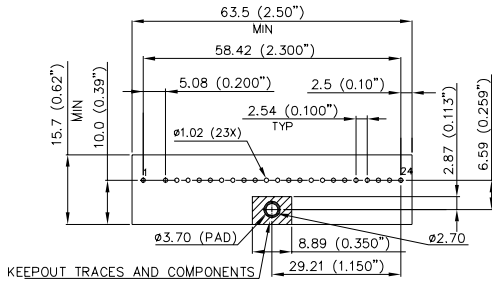

PIN ASSIGNMENT	
PIN#	FUNCTION
1	TRIM
2	KEY
3	GROUND
4	PWRGD
5	NC
6	NC
7	GROUND
8	GROUND
9	Enable
10	-SENSE
11	+SENSE
12	I2VIN
13	I2VIN
14	I2VIN
15	VOUT
16	VOUT
17	GROUND
18	VOUT
19	GROUND
20	VOUT
21	GROUND
22	VOUT
23	GROUND
24	VOUT

NOTES:
 DIMENSIONS ARE IN MILLIMETERS AND (INCHS)
 TOLERANCE: X.X mm±0.5 mm(X.XX in.±0.02 in.)
 X.XX mm±0.25 mm(X.XXX in.±0.010 in.)

HORIZONTAL

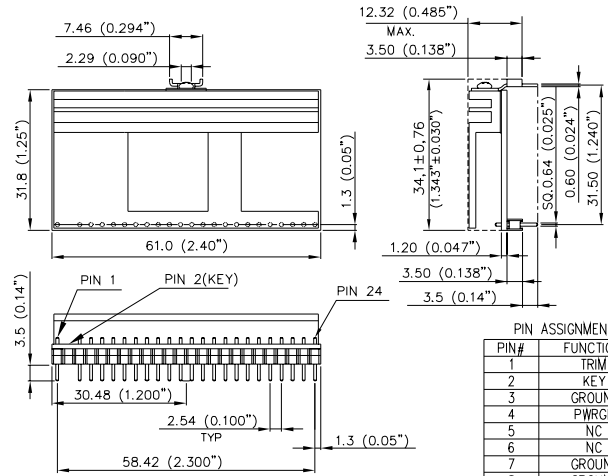

SUGGESTED PCB LAYOUT

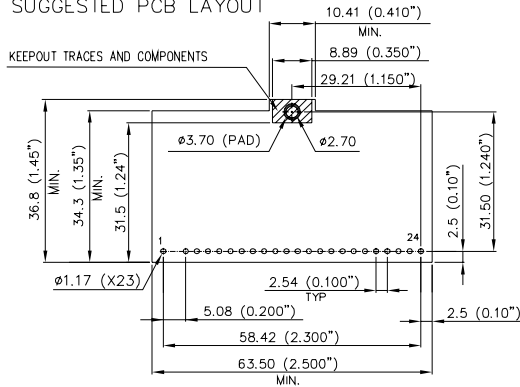

PIN ASSIGNMENT	
PIN#	FUNCTION
1	TRIM
2	KEY
3	GROUND
4	PWRGD
5	NC
6	NC
7	GROUND
8	GROUND
9	Enable
10	-SENSE
11	+SENSE
12	I2VIN
13	I2VIN
14	I2VIN
15	VOUT
16	VOUT
17	GROUND
18	VOUT
19	GROUND
20	VOUT
21	GROUND
22	VOUT
23	GROUND
24	VOUT

PART NUMBERING SYSTEM

NC	12	S	0A0	V	40	P	N	F	A
Product Series	Input Voltage	Number of outputs	Output Voltage	Mounting	Output Current	ON/OFF Logic	Pin Length		Option Code
NC- Non-isolated Converter	12- 10.2~13.8V	S- Single output	0A0- programmable	H- Horizontal V- Vertical	40- 40A	P- Positive N- Negative	R- 0.118" N- 0.140"	F- RoHS 6/6 (Lead Free)	A- Standard Functions

MODEL LIST

Model Name	Packaging	Input Voltage	Output Voltage	Output Current	Efficiency 12Vin @ 100% load
NC12S0A0V40PNFA	Vertical	10.2 ~ 13.8Vdc	0.9 V ~ 5.0Vdc	40A	92% (5.0V)
NC12S0A0H40PNFA	Horizontal	10.2 ~ 13.8Vdc	0.9 V ~ 5.0Vdc	40A	92% (5.0V)

CONTACT: www.delta.com.tw/dcdc

USA:

Telephone:
East Coast: (888) 335 8201
West Coast: (888) 335 8208
Fax: (978) 656 3964
Email: DCDC@delta-corp.com

Europe:

Telephone: +41 31 998 53 11
Fax: +41 31 998 53 53
Email: DCDC@delta-es.tw

Asia & the rest of world:

Telephone: +886 3 4526107 x6220
Fax: +886 3 4513485
Email: DCDC@delta.com.tw

WARRANTY

Delta offers a two (2) year limited warranty. Complete warranty information is listed on our web site or is available upon request from Delta.

Information furnished by Delta is believed to be accurate and reliable. However, no responsibility is assumed by Delta for its use, nor for any infringements of patents or other rights of third parties, which may result from its use. No license is granted by implication or otherwise under any patent or patent rights of Delta. Delta reserves the right to revise these specifications at any time, without notice.