

FEATURES

- 1.5A Bipolar Switch
- Controlled Output Slew Rate ($2V/\mu s$) to Limit R.F.I. Generation
- 60V Load Dump Capability with Inductive Kickback
- Internal Negative Voltage Clamp for Inductive Loads
- $500\mu A$ Standby Current
- Logic Input — TTL Levels
- Low Input Bias Current ($20\mu A$)
- Status Output
- Short Circuit Detection and Shutoff
- Open Circuit Detection
- Overtemp Detection and Shutoff

APPLICATIONS

- Solenoid Driver
- Relay Driver
- Motor Driver

DESCRIPTION

The LT1188 is a monolithic high side switch employing bipolar technology. The device is designed to operate in harsh environments such as those encountered in the automotive industry. The device incorporates an internal clamp diode to clamp the negative voltage spikes generated by inductive loads such as solenoids and is capable of withstanding load dumps of 60V on the supply pin while clamping such spikes. Standby current is only $500\mu A$ and ground pin current, when driving a 1A load, is only 5mA.

The device's input logic levels are designed to be compatible with standard TTL levels while drawing only $20\mu A$ in the on state. A status output is provided to inform the user of the condition of the output load as well as the switch. The status pin will change state for shorted as well as open loads and will also indicate when the device is above normal operating temperature. The device protects itself against short circuited loads by limiting output current and then shutting itself off after a specified time if the short remains. The device protects itself against overtemperature by shutting itself off. Overtemperature shutoff occurs at a temperature above where the status pin overtemp indication occurs, allowing the user time to recognize and possibly correct the problem before drive to the load is removed.

BLOCK DIAGRAM

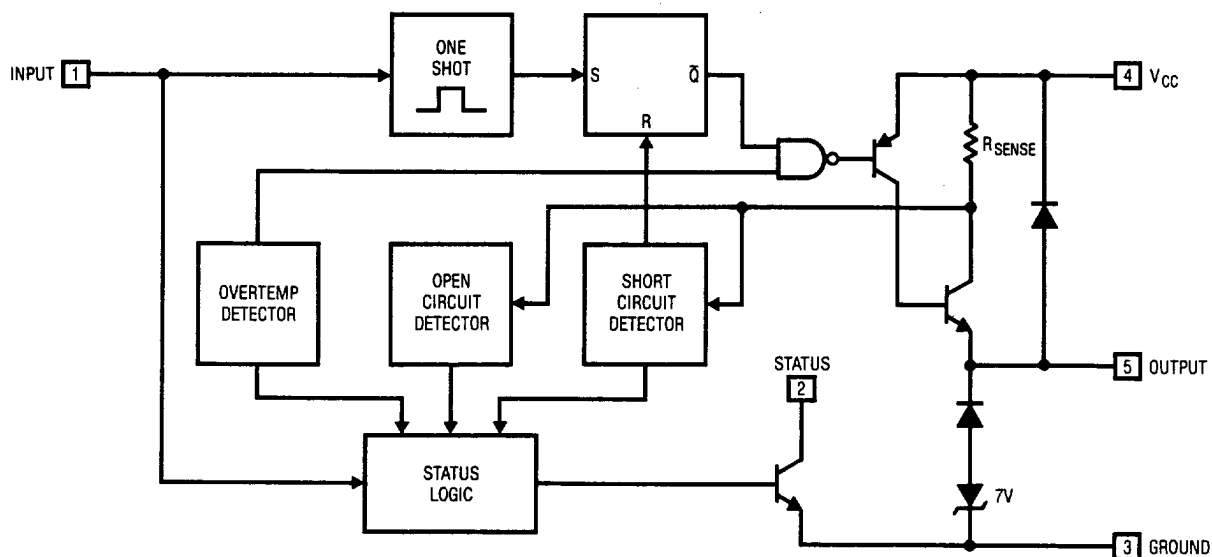

ABSOLUTE MAXIMUM RATINGS

Supply Voltage	30V
Supply Voltage (Transient 200ms)	60V
Logic Input Voltage	30V
Operating Temperature Range	
LT1188M	-55°C to 125°C
LT1188C	0°C to 70°C
Junction Temperature Range	
LT1188M	-55°C to 175°C
LT1188C	0°C to 100°C
Storage Temperature	-65°C to 150°C
Lead Temperature (Soldering, 10 sec)	300°C

PACKAGE/ORDER INFORMATION

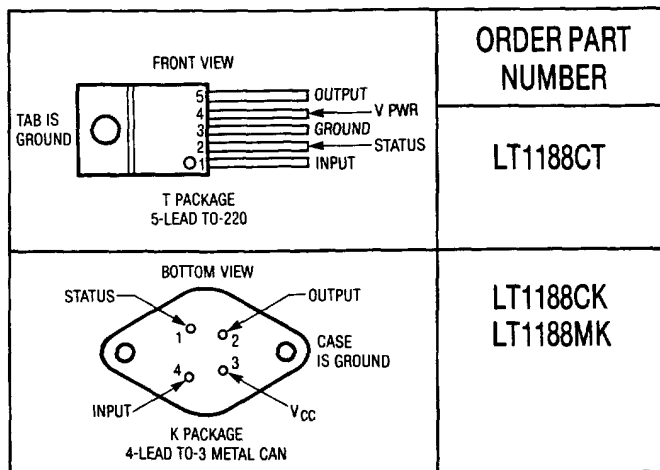

ORDER PART NUMBER

LT1188CT

LT1188CK
LT1188MK

ELECTRICAL CHARACTERISTICS (Note 1)

PARAMETER	CONDITIONS	MIN	TYP	MAX	UNITS	
Switch Voltage Loss (V _{CC} -V _{OUT} , Switch On)	I _{OUT} = 1.0A, 5V ≤ V _{CC} ≤ 30V	●	1.0	1.2	V	
	I _{OUT} = 1.5A, 5V ≤ V _{CC} ≤ 30V	●	1.2	1.4	V	
Output Leakage Current	V _{CC} = 30V, V _{OUT} = 0V, V _{IN} = 0V	●	5	150	μA	
High Level Input Voltage	5V ≤ V _{CC} ≤ 30V, I _{OUT} = 1.5A, (Note 2)	●	2.0		V	
Low Level Input Voltage	5V ≤ V _{CC} ≤ 30V, I _{OUT} = 0.0A, (Note 3)	●		0.8	V	
High Level Input Current	5V ≤ V _{CC} ≤ 30V, V _{IN} = 2.0V	●	5	20	60	μA
Low Level Input Current	5V ≤ V _{CC} ≤ 30V, V _{IN} = 0.4V	●	0	1		μA
Status Pin Saturation Voltage	5V ≤ V _{CC} ≤ 30V, I _{STATUS} = 1mA	●	0.2	0.4		V
Status Leakage Current	V _{CC} = 30V, V _{STAT} = 5.5V	●		1		μA
Standby Current	V _{IN} = 0.4V, R _L = ∞, V _{CC} = 30V Status = High	●	500	650		μA
	Status = Low	●	550	750		μA
Ground Pin Current	V _{CC} = 30V, I _{OUT} = 1.5A	●	9	15		mA
Clamp Voltage	I _{CLAMP} = 1.0A, (Note 4)	●	8	10		V
	I _{CLAMP} = 1.5A, (Note 4)	●	9	12		V
Turn-On Delay	(Note 5)	●		30		μs
Turn-Off Delay	(Note 6)	●		30		μs
Output Slew Rate	V _{CC} = 17V, R _L = 16Ω Output Rising	●	0.5	1.2	5.0	V/μs
	Output Falling	●	0.5	2.0	5.0	V/μs
Short Circuit Current	V _{CC} -V _{OUT} = 7V	●	2.0	3.5	4.7	A
	V _{CC} -V _{OUT} = 17V	●		2.5		A
	V _{CC} -V _{OUT} = 30V	●	1.5		4.0	A
	V _{CC} -V _{OUT} = 30V	●	0.5	1.5	3.0	A

4

ELECTRICAL CHARACTERISTICS (Note 1)

PARAMETER	CONDITIONS	MIN	TYP	MAX	UNITS
Short Circuit Sense Time (t_{SC})	$V_{CC} = 30V$	20	50	110	μS
Status Reset Time (t_R)	$V_{CC} = 30V$	350	600	950	μS
Open Circuit Current Trip Level		18	40	75	mA
Overtemp Detection Point			150		$^{\circ}C$
Thermal Resistance	Junction to Case (Note 7)			4.0	$^{\circ}C/W$

Note 1: The ● denotes specifications which apply over the full operating temperature range.

Note 2: 2.0V is the minimum input voltage guaranteed to turn the device on. For input voltages greater than 2.0V the output voltage is guaranteed to be turned on.

Note 3: 0.8V is the maximum input voltage guaranteed to turn the device off. For input voltages less than 0.8V the device is guaranteed to be turned off.

Note 4: The negative voltage clamp is designed for intermittent operation such as clamping the reverse voltage spike caused by an inductive load. Clamp duration should be less than 100ms.

Note 5: Turn on delay time is defined to be the time from the rising edge of the input signal to the time that the output voltage is equal to 2V.

Note 6: Turn off delay time is defined to be the time from the falling edge of the input signal to the time that the output drops by 2V.

Note 7: Thermal resistance is from the junction of the switch transistor to the back of the case directly below the switch transistor. The device will be centered in the package and proper mounting techniques are required in order to have good thermal conduction away from this area of the package.

TYPICAL PERFORMANCE CHARACTERISTICS

Switch Voltage Loss

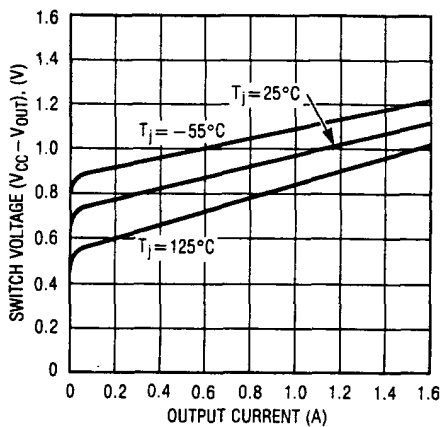

Short Circuit Current

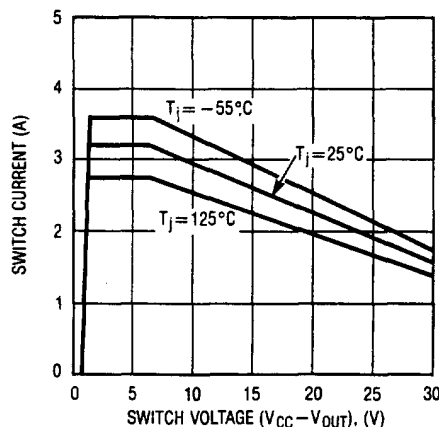

Input Current

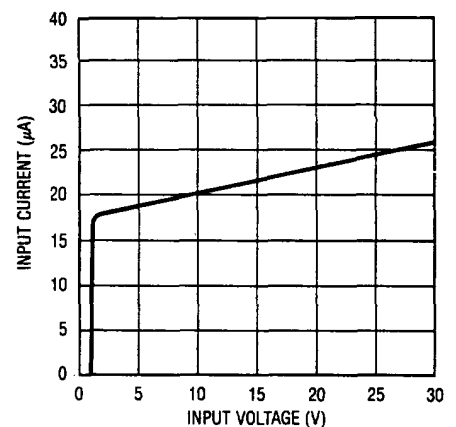

TYPICAL PERFORMANCE CHARACTERISTICS

Clamp Voltage

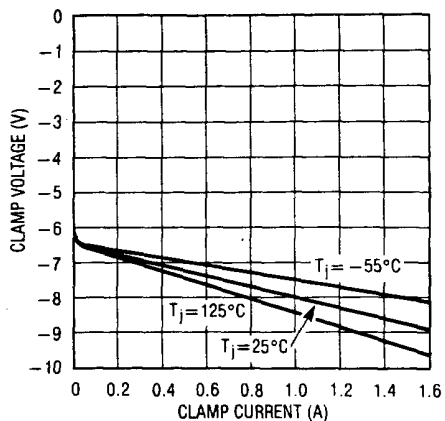

Slew Rate

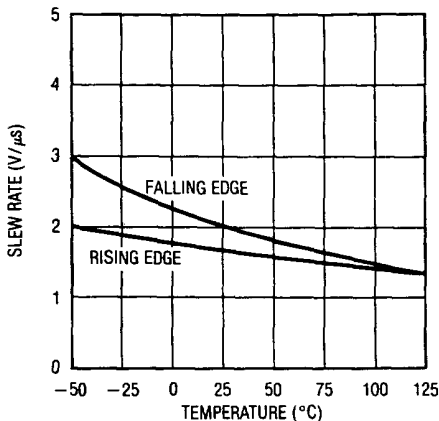

Open Circuit Detection Current

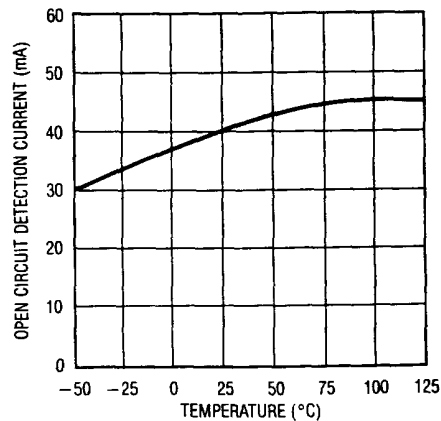

Input Threshold Voltage

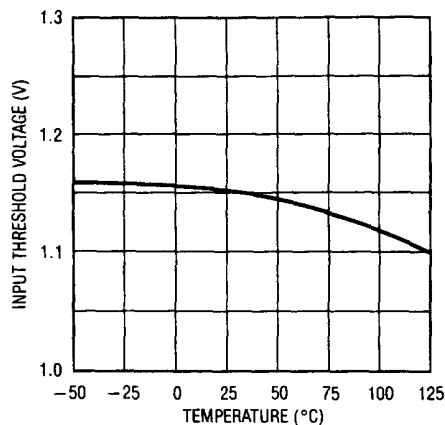

Supply Current (Switch Off)

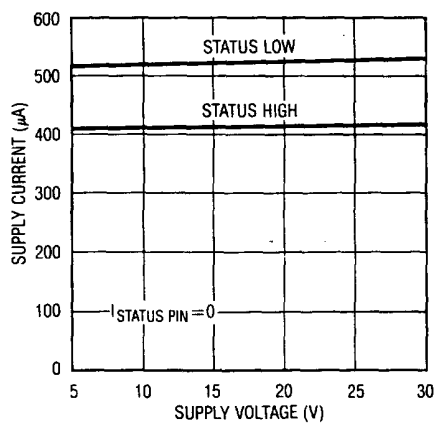

Ground Pin Current (Switch On)

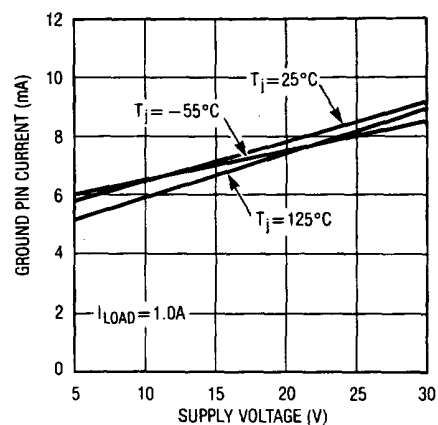

4

Short Circuit Sense Time

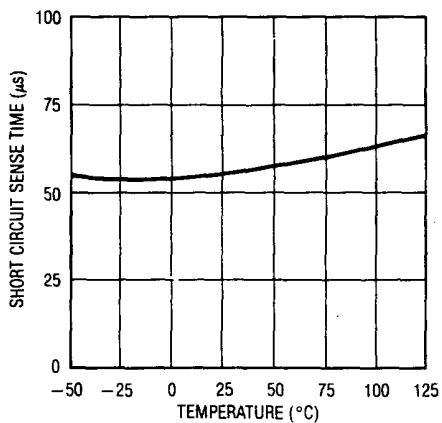

Status Reset Time

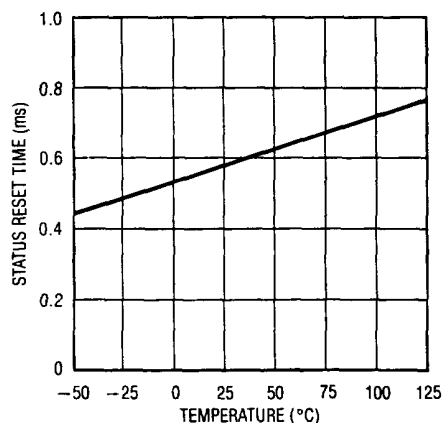

PIN FUNCTIONS

Output: As can be seen from the block diagram the output of the device is the emitter of an NPN power transistor which can source current from the supply. The slew rate of the output, both rising and falling, is controlled to minimize the generation of RFI. In the negative direction the output pin is clamped to ground with a combination diode/zener clamp. This clamp is designed to clamp the flyback voltage spike of an inductive load such as a solenoid. This clamp is designed for intermittent operation. The duration of the flyback spike should be less than 100ms. This allows a wide range of inductive loads. In the positive direction the output pin is clamped to the supply with a diode.

Ground: The ground pin of the device must be connected for the device to turn on. For an open ground pin the device will be in an off state.

Input: The input pin of the device must be driven above the input voltage threshold for the device to turn on. The input voltage threshold is designed to be compatible with standard TTL levels, while the input impedance is high. Input current above the threshold is typically 20 μ A. For an open input pin the device will remain in an off state. The input

logic requires a minimum input voltage slew rate of 3V/ms. This is several orders of magnitude slower than any logic family currently in use and should not normally cause any problems.

Status: The status output is the collector of a grounded emitter NPN transistor whose base is internally driven by the status logic. A logic low indicates a fault condition (see Truth Table). This output requires an external pull-up resistor that should be chosen so that the current into the status pin, when the status pin is pulled low, is < 1mA. The breakdown voltage of this NPN collector is equal to that of the output switch.

Diagnostic Truth Table

	Input	Output	Status
Normal Operation	L	L	H
	H	H	H
Open Load	L	X	H
	H	H	L
Shorted Load	L	L	L
	H	L	L
Thermal Overload	L	L	H
	H	L	L

STATUS FUNCTIONS

Open Circuit Fault: The status output will be pulled low if the output current drops below the open circuit current threshold (typically 40mA). The open circuit detector is only active during the time that the switch is on (input high), and will only affect the status output during that time. For open circuit faults the status output will not latch low. The status line will be low only as long as the fault condition exists.

Short Circuit Fault: For short circuit faults lasting longer than the short circuit sense time ($\approx 60\mu$ s), two things will occur; the output switch will be latched off and the status output will be latched low. The output will remain off until the input is recycled. The status output will remain low until both the short is removed and the input is recycled, and will be reset high after the status reset time ($\approx 500\mu$ s) has elapsed. For continuous shorts the output will turn on, for the short circuit sense time, each time the input is cycled

and the status output will remain latched low. The current at which the short circuit detector activates is a function of the supply voltage as can be seen by looking at the short circuit current curve in the typical performance characteristics.

Thermal Fault: Thermal faults can occur for two reasons, heating from external sources or heating due to power dissipation in the switch itself. The device will act similarly for both cases. Thermal faults will only affect the status output during the time that the switch is on (input high). Thermal faults will cause the status output to latch low for the duration of an input cycle. The status output will be reset on the falling edge of the input waveform. There are two levels of thermal overload. At $\approx 150^\circ\text{C}$ junction temperature the thermal sensing circuitry will latch the status output low, and the output will remain on (as long as the input is high). At $\approx 165^\circ\text{C}$ the thermal sensing circuitry will

STATUS FUNCTIONS

turn the output off. If the junction temperature drops back below $\approx 165^{\circ}\text{C}$ the output will turn back on. This means that if the thermal fault is caused by an external source the output will stay off as long as the temperature is held above $\approx 165^{\circ}\text{C}$. If the thermal fault is caused by internal power dissipation, the device will cycle on and off to maintain the junction temperature near 165°C . The status output gives a fault indication at a temperature below the actual shutdown temperature to allow the user time to sense and possibly correct the fault condition before the switch takes action to protect itself.

Load Dump: For transient supply voltages greater than 35V or for transient switch voltages greater than 35V, a separate clamp network will turn the output off. This is necessary to keep the switch within its safe operating area and also to prevent the device from passing the high

voltage transient on to the load. To guarantee survival of the switch for load dump type transients the risetime of the supply voltage, at the supply pin of the device, should be limited to $< 1\text{V}/\mu\text{s}$. This is to allow the device time to turn off between when the supply voltage reaches 35V and when the supply voltage reaches 50V so that the device is turned off well below its BVCEO voltage. If the device is bypassed closely, the series inductance and resistance of the supply leads along with the supply bypass capacitor will form an RLC filter and will limit the risetime. The slew rate limiting circuitry will be disabled during this transient turn off time. The output will remain off until the supply voltage drops back below 35V. During the time that the output is turned off by this clamp network the open circuit detector will still be active and will set the status pin low until the output comes back on and the output current is greater than the open circuit current.

4

TYPICAL APPLICATIONS

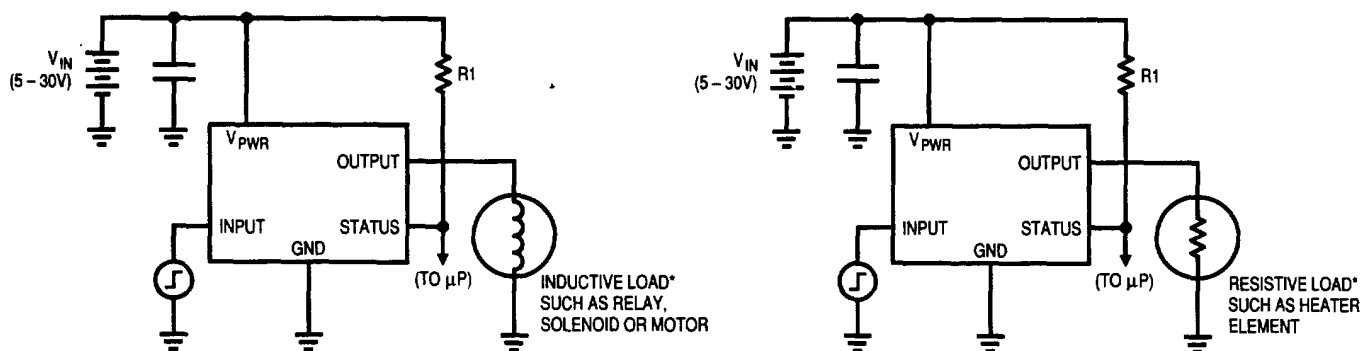

* THE LT1188 IS NOT RECOMMENDED FOR DRIVING LIGHT BULBS DUE TO THEIR INHERENTLY HIGH INRUSH CURRENTS. HIGH INRUSH CURRENTS WILL ACTIVATE THE SHORT CIRCUIT PROTECTION CIRCUITRY OF THE DEVICE, CAUSING IT TO SHUT OFF AFTER $\approx 50\mu\text{s}$ (SHORT CIRCUIT SENSE TIME).

TIMING DIAGRAM

