

## Schottky Barrier Diode

## B5817WS-B5819WS

### FEATURES

- Extremely low  $V_F$ .
- Low stored charge, majority carrier conduction.
- Low power loss/high efficient

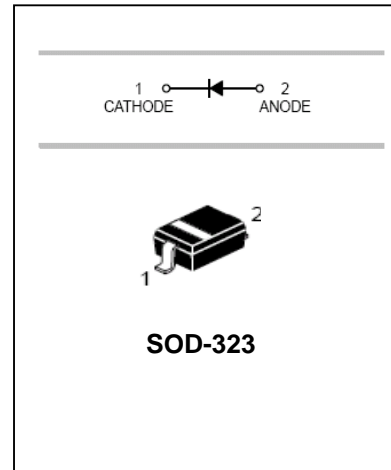

### APPLICATIONS

- For Use In Low Voltage, High Frequency Inverters.
- Free Wheeling, And Polarity Protection Applications.

### ORDERING INFORMATION

Type No.	Marking	Package Code
B5817WS	SJ	SOD-323
B5818WS	SK	SOD-323
B5819WS	SL	SOD-323

### MAXIMUM RATING @ $T_a=25^\circ\text{C}$ unless otherwise specified

Parameter	symbol	B5817WS	B5818WS	B5819WS	Unit
Non-Repetitive Peak reverse voltage	$V_{RM}$	20	30	40	V
Peak repetitive Peak reverse voltage	$V_{RRM}$	20	30	40	V
Working Peak Reverse voltage	$V_{RWM}$				
DC Reverse Voltage	$V_R$				
RMS Reverse Voltage	$V_{R(RMS)}$	14	21	28	V
Average Rectified output Current	$I_o$	1			A
Peak forward surge current@=8.3ms	$I_{FSM}$	25			A
Repetitive Peak Forward Current	$I_{FRM}$	625			mA
Power Dissipation	$P_d$	250			mW
Thermal Resistance Junction to Ambient	$R_{\theta JA}$	500			$^\circ\text{C}/\text{W}$
Storage temperature	$T_{STG}$	-65~+150			$^\circ\text{C}$

## Schottky Barrier Diode

## B5817WS-B5819WS

### ELECTRICAL CHARACTERISTICS @ Ta=25°C unless otherwise specified

Parameter	Symbol	Test Condition	MIN	MAX	UNIT
Reverse breakdown voltage	$V_{(BR)}$	$I_R=1mA$			
		B5817WS	20		V
		B5818WS	30		
		B5819WS	40		
Reverse voltage leakage current	$I_R$	$V_R=20V$	B5817WS		
		$V_R=30V$	B5818WS		1
		$V_R=40V$	B5819WS		
Forward voltage	$V_F$	B5817WS	$I_F=1A$		0.45
			$I_F=3A$		0.75
		B5818WS	$I_F=1A$		0.55
			$I_F=3A$		0.875
		B5819WS	$I_F=1A$		0.6
			$I_F=3A$		0.9
Diode capacitance	$C_D$	$V_R=4V, f=1MHz$		120	pF

### TYPICAL CHARACTERISTICS @ Ta=25°C unless otherwise specified

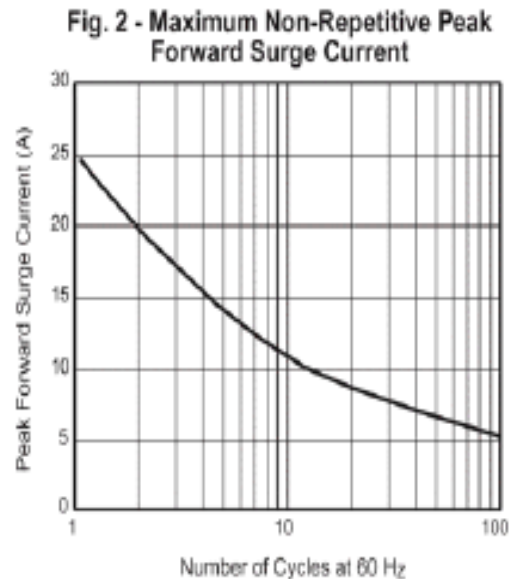
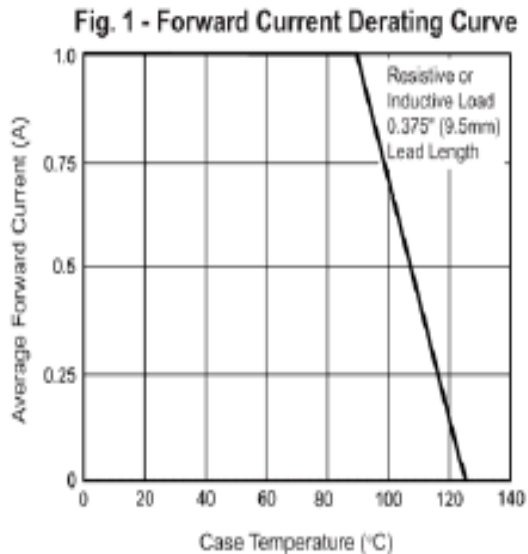

## Schottky Barrier Diode

## B5817WS-B5819WS

**Fig. 3 - Typical Instantaneous Forward Characteristics**

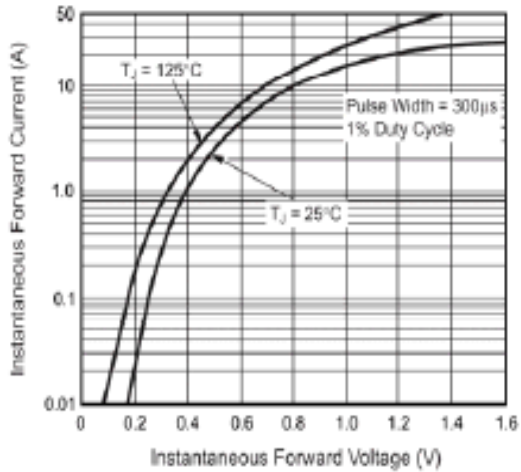

**Fig. 4 - Typical Reverse Characteristics**

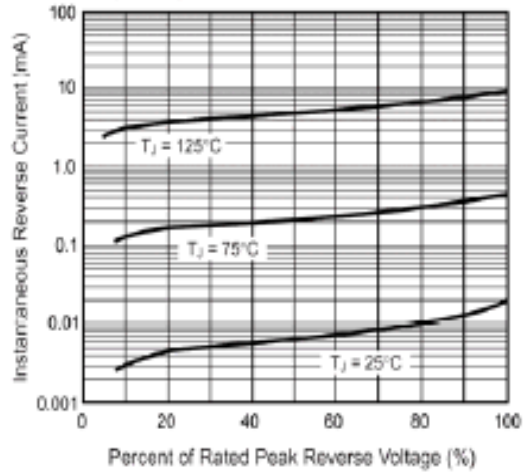

**Fig. 5 - Typical Junction Capacitance**

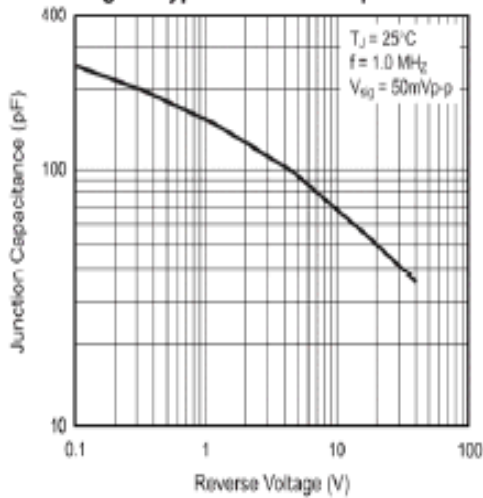

**Fig. 6 - Typical Transient Thermal Impedance**

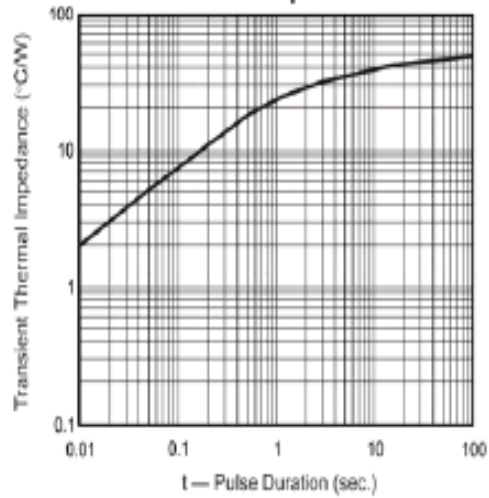

## Schottky Barrier Diode

## B5817WS-B5819WS

### PACKAGE OUTLINE

Plastic surface mounted package

SOD-323

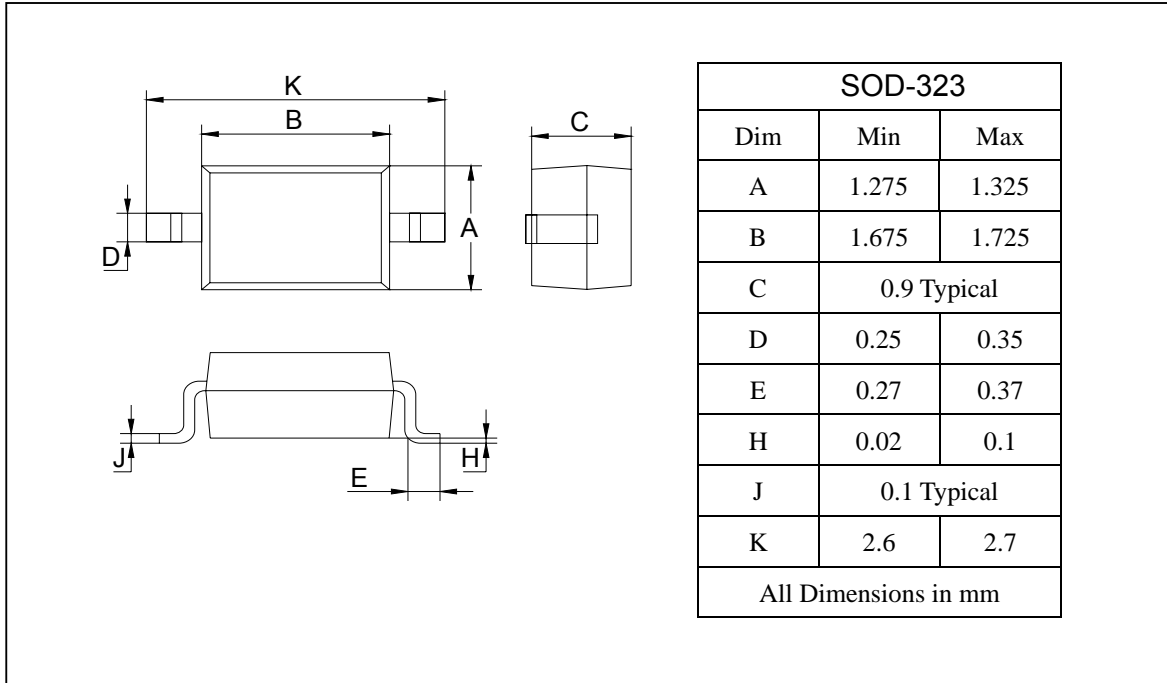

### SOLDERING FOOTPRINT

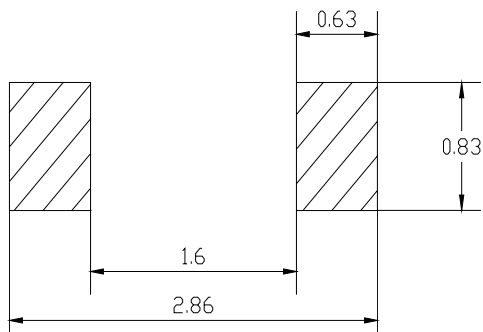

Unit : mm

### PACKAGE INFORMATION

Device	Package	Shipping
B5817WS-B5819WS	SOD-323	3000/Tape&Reel