

# Distinctive Characteristics

Subminiature size (1/3 size of Series M switches) saves space on PC boards.

Specifically developed for logic-level applications.

Award-winning STC contact mechanism with benefits unavailable in conventional mechanisms: smoother, positive detent actuation, increased contact stability and unparalleled logic-level reliability. (Additional STC details in Terms & Acronyms; see Supplement section.)

Available in various actuator lengths.

Antistatic superstructure of carbon blended polyacetal prevents static discharge to the contacts.

Molded-in, epoxy sealed or ultrasonically welded terminals lock out flux, solvents, and other contaminants.

.100" x .100" (2.54mm x 2.54mm) terminal spacing conforms to standard PC board grid spacing.

Matching indicators available and shown at the end of Section M.

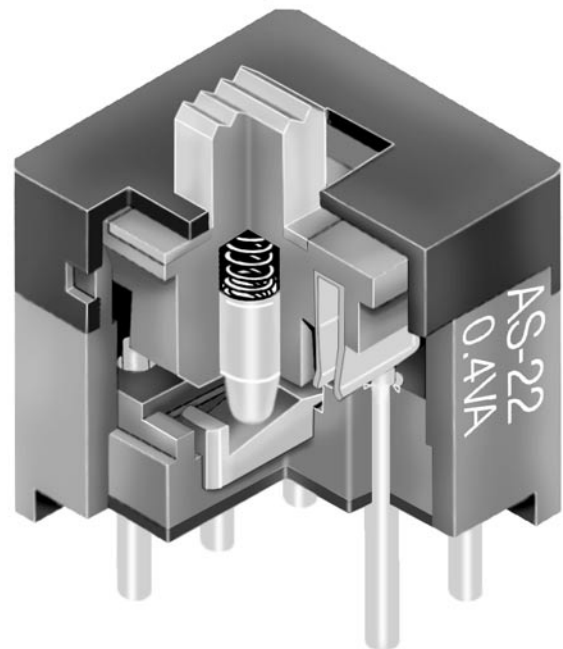

Actual Size

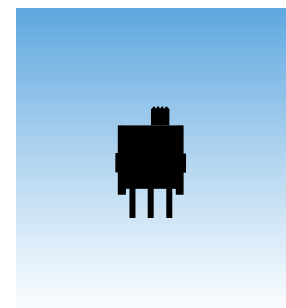

# General Specifications

## Electrical Capacity (Resistive Load)

**Logic Level:** 0.4VA maximum @ 28V AC/DC maximum  
 (Applicable Range 0.1mA ~ 0.1A @ 20mV ~ 28V)  
 Note: Find additional explanation of operating range in Supplement section.

## Other Ratings

**Contact Resistance:** 50 milliohms maximum  
**Insulation Resistance:** 500 megohms minimum @ 500V DC  
**Dielectric Strength:** 500V AC minimum for 1 minute minimum  
**Mechanical Life:** 50,000 operations minimum  
**Electrical Life:** 50,000 operations minimum  
**Nominal Operating Force:** 2.55N  
**Contact Timing:** Nonshorting (break-before-make)  
**Travel:** Pretravel: .082" (2.1mm); Overtravel: .016" (0.4mm); Total Travel: .098" (2.5mm)

## Materials & Finishes

**Actuator:** Glass fiber reinforced polyamide  
**Upper Case Housing:** Carbon blended polyacetal (antistatic)  
**Lower Case Housing:** Glass fiber reinforced polyamide  
**Support Bracket:** Tin plated phosphor bronze  
**Movable Contact:** Phosphor bronze with gold plating  
**Stationary Contacts:** Brass with gold plating  
**Terminals:** Brass with gold plating

## Environmental Data

**Operating Temperature Range:** -30°C through +85°C (-22°F through +185°F)  
**Humidity:** 90 ~ 95% humidity for 192 hours @ 40°C (104°F)  
**Vibration:** 10 ~ 60Hz with peak-to-peak amplitude of 1.5mm traversing the frequency range & returning in 5 minutes; 3 right angled directions for 30 minutes  
**Shock:** 50G (490m/s<sup>2</sup>) acceleration (tested in 6 right angled directions, with 5 shocks in each direction)

## PCB Processing

**Soldering:** Wave Soldering Recommended. See Profile A in Supplement section.  
 Manual Soldering: for single pole see Profile B in Supplement section; for double pole see Profile A.  
**Cleaning:** These devices are not process sealed. Hand clean locally using alcohol based solution.

## Standards & Certifications

**UL Recognition or CSA Certification:** The A Series slides have not been tested for UL recognition or CSA certification. These switches are designed for use in a low-voltage, low-current, logic-level circuit. When used as intended in a logic-level circuit, the results do not produce hazardous energy.

## TYPICAL SWITCH ORDERING EXAMPLE

AS      2      2      A      H

POLES		CIRCUITS				ACTUATORS		PC TERMINALS	
1	SPST SPDT	1	ON	NONE	OFF	A	.098" (2.5mm) Long	P	Straight
2	DPDT SP3T	2	ON	NONE	ON	B	Flush	*B	Straight with Bracket
		3	ON	OFF	ON	C	.150" (3.8mm) Long	*H	Right Angle with Bracket
		4	ON	ON	ON			*V	Vertical with Bracket

\*Bracketed models are ESD protected

### DESCRIPTION FOR TYPICAL ORDERING EXAMPLE

AS22AH







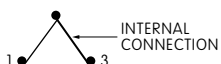

DPDT  
ON-NONE-ON Circuit

.098" (2.5mm) Long  
Actuator

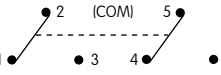

Right Angle PC Terminals

## POLES & CIRCUITS

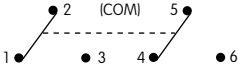
		Slide Position			Connected Terminals			Throw & Schematics
Pole	Model	Left	Center	Right	Left	Center	Right	
SP	AS11							Note: Terminal numbers are not actually on the switch.
SP	AS12 AS13	ON ON	NONE OFF	ON ON	3-1 2-1	OPEN OPEN	OPEN 2-3 2-3	SPST 
DP	AS22 AS23	ON ON	NONE OFF	ON ON	2-1 5-4 2-1 5-4	OPEN OPEN	2-3 5-6 2-3 5-6	SPDT 
		ON ON	NONE OFF	ON ON	2-1 5-4 2-1 5-4	OPEN OPEN	2-3 5-6 2-3 5-6	DPDT 

### For 3 Throw (3-On)

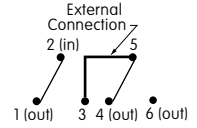
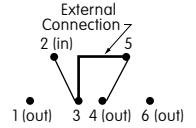
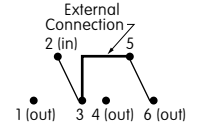
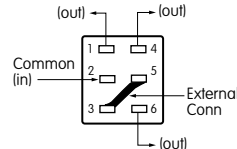
		Connected Terminals & Schematics			External Connection
Pole	Model	Left	Center	Right	
SP	AS24	ON	ON	ON	The SP3T model utilizes a double pole base.
		 2-1 5-4	 2-3 5-4	 2-3 5-6	External connections must be made during field installation.
					

## ACTUATORS

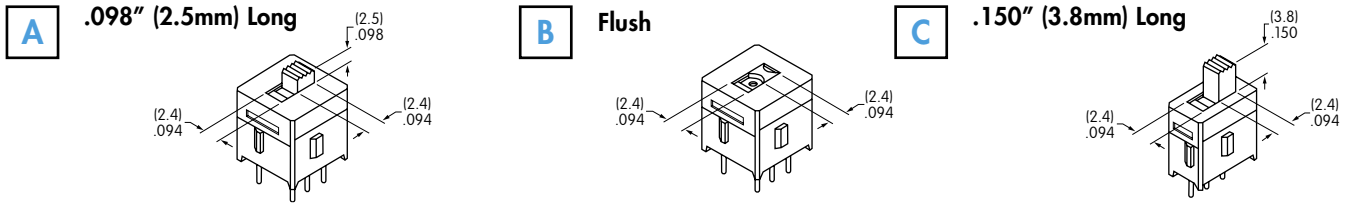

Actuator Color: Gray standard; contact factory for other colors.

## PC TERMINALS

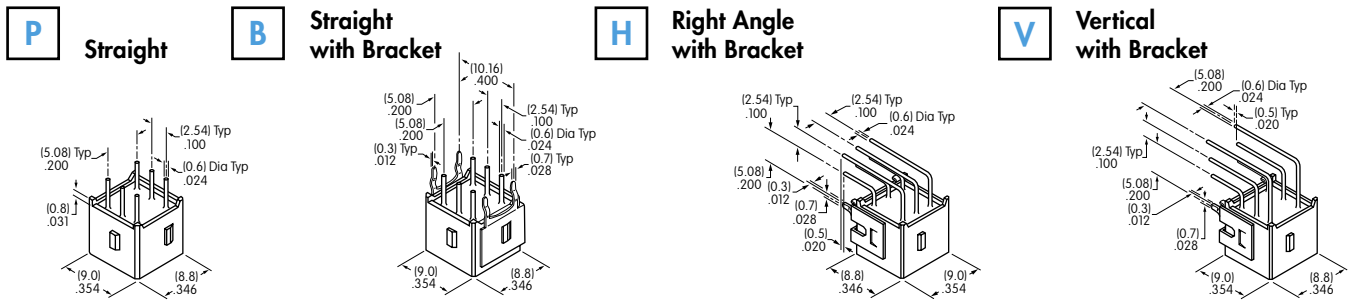

Use of a support bracket is recommended to increase PCB mounting strength and stability.

## TYPICAL SWITCH DIMENSIONS

### Straight PC



AS12AP

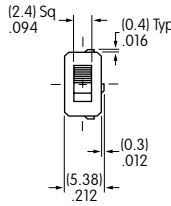

### Single Pole

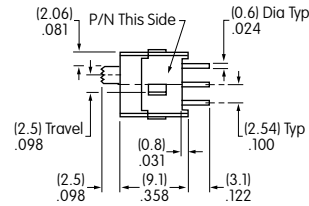

Actuator shown in LEFT position

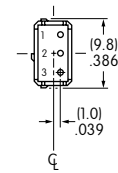

Single throw models do not have terminal 2.

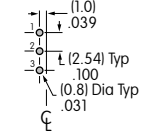

### Straight PC



AS22AP

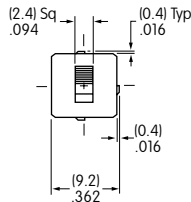

### Double Pole

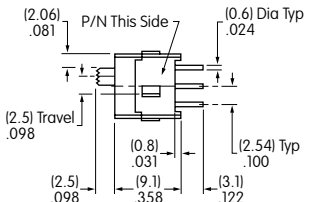

Actuator shown in LEFT position

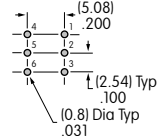
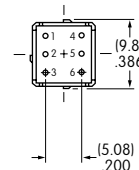

### Straight PC • Bracket



AS12AB

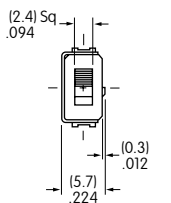

### Single Pole

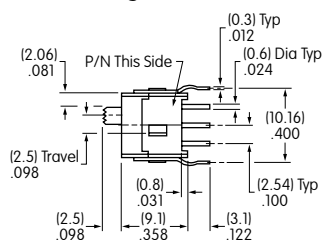

Actuator shown in LEFT position

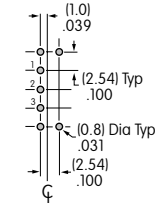
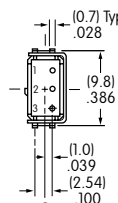

## TYPICAL SWITCH DIMENSIONS

### Straight PC • Bracket



AS22AB

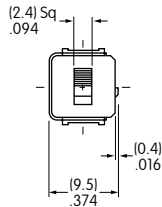

### Double Pole

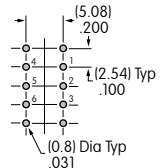
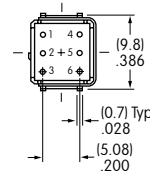
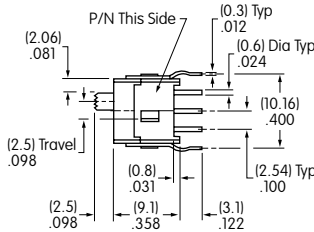

Actuator shown in LEFT position

### Right Angle PC



AS12AH

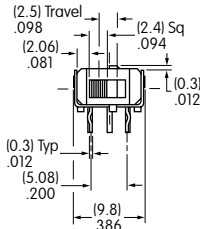

### Single Pole

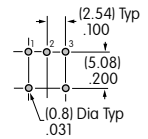
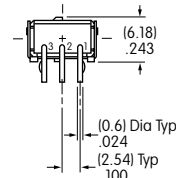
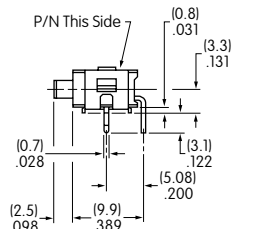

Actuator shown in LEFT position

### Right Angle PC



AS22AH

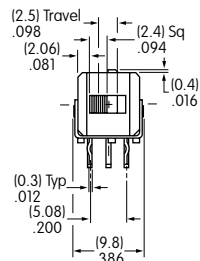

### Double Pole

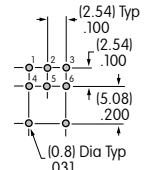
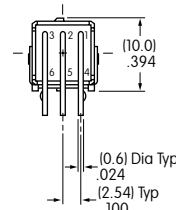
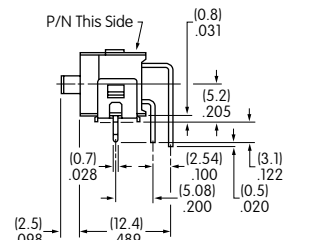

Actuator shown in LEFT position

### Vertical PC



AS12AV

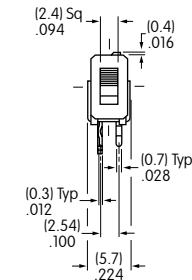

### Single Pole

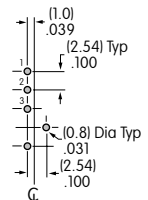
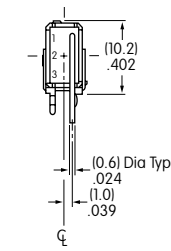
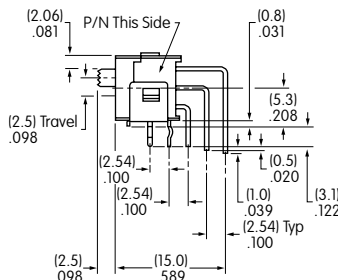

Actuator shown in LEFT position

### Vertical PC



AS22AV

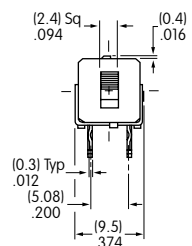

### Double Pole

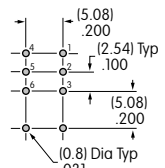
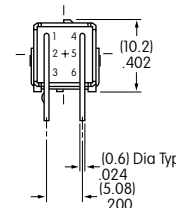
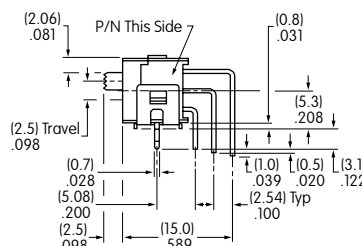

Actuator shown in LEFT position